

# Title 21—Food and Drugs

(This book contains Parts 800 to 1299)

---

	<i>Part</i>
CHAPTER I—Food and Drug Administration, Department of Health and Human Services (Continued) .....	800



# CHAPTER I—FOOD AND DRUG ADMINISTRATION, DEPARTMENT OF HEALTH AND HUMAN SERVICES (CONTINUED)

---

EDITORIAL NOTE: Nomenclature changes to chapter I appear at 59 FR 14366, Mar. 28, 1994;  
68 FR 24879, May 9, 2003; and 69 FR 13717, Mar. 24, 2004.

## SUBCHAPTER H—MEDICAL DEVICES

<i>Part</i>		<i>Page</i>
800	General .....	7
801	Labeling .....	18
803	Medical device reporting .....	50
806	Medical devices; reports of corrections and removals .....	67
807	Establishment registration and device listing for manufacturers and initial importers of devices ...	71
808	Exemptions from Federal preemption of State and local medical device requirements .....	89
809	In vitro diagnostic products for human use .....	98
810	Medical device recall authority .....	107
812	Investigational device exemptions .....	115
813	[Reserved]	
814	Premarket approval of medical devices .....	136
820	Quality system regulation .....	160
821	Medical device tracking requirements .....	174
822	Postmarket surveillance .....	180
830	Unique device identification .....	188
860	Medical device classification procedures .....	197
861	Procedures for performance standards development	210
862	Clinical chemistry and clinical toxicology devices	214
864	Hematology and pathology devices .....	262
866	Immunology and microbiology devices .....	292
868	Anesthesiology devices .....	387
870	Cardiovascular devices .....	411
872	Dental devices .....	445
874	Ear, nose, and throat devices .....	475
876	Gastroenterology-urology devices .....	491
878	General and plastic surgery devices .....	523

21 CFR Ch. I (4–1–20 Edition)

<i>Part</i>		<i>Page</i>
880	General hospital and personal use devices .....	549
882	Neurological devices .....	575
884	Obstetrical and gynecological devices .....	605
886	Ophthalmic devices .....	635
888	Orthopedic devices .....	664
890	Physical medicine devices .....	692
892	Radiology devices .....	717
895	Banned devices .....	735
898	Performance standard for electrode lead wires and patient cables .....	741
SUBCHAPTER I—MAMMOGRAPHY QUALITY STANDARDS ACT		
900	Mammography .....	743
SUBCHAPTER J—RADIOLOGICAL HEALTH		
1000	General .....	778
1002	Records and reports .....	787
1003	Notification of defects or failure to comply .....	795
1004	Repurchase, repairs, or replacement of electronic products .....	799
1005	Importation of electronic products .....	801
1010	Performance standards for electronic products: General .....	805
1020	Performance standards for ionizing radiation emit- ting products .....	810
1030	Performance standards for microwave and radio frequency emitting products .....	842
1040	Performance standards for light-emitting products .....	845
1050	Performance standards for sonic, infrasonic, and ultrasonic radiation-emitting products .....	869
SUBCHAPTER K—TOBACCO PRODUCTS		
1100	Tobacco products subject to FDA authority .....	873
1105	General .....	874
1107	Establishment registration, product listing, and substantial equivalence reports .....	874
1140	Cigarettes, smokeless tobacco, and covered to- bacco products .....	876
1141	Cigarette package and advertising warnings (Eff. until 6-18-21) .....	881
1141	Required warnings for cigarette packages and ad- vertisements (Eff. 6-18-21) .....	885
1143	Minimum required warning statements .....	888

**Food and Drug Administration, HHS**

<i>Part</i>		<i>Page</i>
1150	User fees .....	893
SUBCHAPTER L—REGULATIONS UNDER CERTAIN OTHER ACTS ADMINISTERED BY THE FOOD AND DRUG ADMINISTRATION		
1210	Regulations under the Federal Import Milk Act ....	897
1230	Regulations under the Federal Caustic Poison Act	900
1240	Control of communicable diseases .....	907
1250	Interstate conveyance sanitation .....	912
1251–1269	[Reserved]	
1270	Human tissue intended for transplantation .....	923
1271	Human cells, tissues, and cellular and tissue-based products .....	928
1272–1299	[Reserved]	



## SUBCHAPTER H—MEDICAL DEVICES

### PART 800—GENERAL

#### Subpart A [Reserved]

#### Subpart B—Requirements for Specific Medical Devices

Sec.

800.10 Contact lens solutions; sterility.

800.12 Contact lens solutions and tablets; tamper-resistant packaging.

800.20 Patient examination gloves and surgeons' gloves; sample plans and test method for leakage defects; adulteration.

#### Subpart C—Administrative Practices and Procedures

800.55 Administrative detention.

800.75 Requests for supervisory review of certain decisions made by the Center for Devices and Radiological Health.

AUTHORITY: 5 U.S.C. 551-559; 21 U.S.C. 301-399f.

#### Subpart A [Reserved]

#### Subpart B—Requirements for Specific Medical Devices

##### **§ 800.10 Contact lens solutions; sterility.**

(a)(1) Informed medical opinion is in agreement that all preparations offered or intended for ophthalmic use, including contact lens solutions, should be sterile. It is further evident that such preparations purport to be of such purity and quality as to be suitable for safe use in the eye.

(2) The Food and Drug Administration concludes that all such preparations, if they are not sterile, fall below their professed standard of purity or quality and may be unsafe. In a statement of policy issued on September 1, 1964, the Food and Drug Administration ruled that liquid preparations offered or intended for ophthalmic use that are not sterile may be regarded as adulterated within the meaning of section 501(c) of the Federal Food, Drug, and Cosmetic Act (the act), and, further, may be deemed misbranded within the meaning of section 502(j) of the act. By this regulation, this ruling is applicable to all preparations for oph-

thalmic use that are regulated as medical devices, i.e., contact lens solutions. By the regulation in §200.50 of this chapter, this ruling is applicable to ophthalmic preparations that are regulated as drugs.

(3) The containers shall be sterile at the time of filling and closing, and the container or individual carton shall be so sealed that the contents cannot be used without destroying the seal. The packaging and labeling of these solutions shall also comply with §800.12 on tamper-resistant packaging requirements.

(b) Liquid ophthalmic preparations packed in multiple-dose containers should:

(1) Contain one or more suitable and harmless substances that will inhibit the growth of microorganisms; or

(2) Be so packaged as to volume and type of container and so labeled as to duration of use and with such necessary warnings as to afford adequate protection and minimize the hazard of injury resulting from contamination during use.

(c) Eye cups, eye droppers, and other dispensers intended for ophthalmic use should be sterile, and may be regarded as falling below their professed standard of purity or quality if they are not sterile. These articles, which are regulated as medical devices unless packaged with the drugs with which they are to be used, should be packaged so as to maintain sterility until the package is opened and be labeled, on or within the retail package, so as to afford adequate directions and necessary warnings to minimize the hazard of injury resulting from contamination during use.

[47 FR 50455, Nov. 5, 1982]

##### **§ 800.12 Contact lens solutions and tablets; tamper-resistant packaging.**

(a) *General.* Unless contact lens solutions used, for example, to clean, disinfect, wet, lubricate, rinse, soak, or store contact lenses and salt tablets or other dosage forms to be used to make any such solutions are packaged in tamper-resistant retail packages, there

is the opportunity for the malicious adulteration of these products with risks both to individuals who unknowingly purchase adulterated products and with loss of consumer confidence in the security of the packages of over-the-counter (OTC) health care products. The Food and Drug Administration has the authority and responsibility under the Federal Food, Drug, and Cosmetic Act (the act) to establish a uniform national standard for tamper-resistant packaging of those OTC products vulnerable to malicious adulteration that will improve the security of OTC packaging and help assure the safety and effectiveness of the products contained therein. A contact lens solution or tablet or other dosage form to be used to make such a solution for retail sale that is not packaged in a tamper-resistant package and labeled in accordance with this section is adulterated under section 501 of the act or misbranded under section 502 of the act, or both.

(b) *Requirement for tamper-resistant package.* Each manufacturer and packer who packages for retail sale a product regulated as a medical device that is a solution intended for use with contact lenses, e.g., for cleaning, disinfecting, wetting, lubricating, rinsing, soaking, or storing contact lenses or tablets or other dosage forms to be used to make any such solution shall package the product in a tamper-resistant package, if this product is accessible to the public while held for sale. A tamper-resistant package is one having an indicator or barrier to entry which, if breached or missing, can reasonably be expected to provide visible evidence to consumers that tampering has occurred. To reduce the likelihood of substitution of a tamper-resistant feature after tampering, the indicator or barrier to entry is required to be distinctive by design or by the use of an identifying characteristic (e.g., a pattern, name, registered trademark, logo, or picture). For purposes of this section, the term “distinctive by design” means the package cannot be duplicated with commonly available material or through commonly available processes. A tamper-resistant package may involve an immediate-container and closure system or secondary-con-

tainer or carton system or any combination of systems intended to provide a visual indication of package integrity. The tamper-resistant feature shall be designed to and shall remain intact when handled in a reasonable manner during manufacture, distribution, and retail display.

(c) *Labeling.* Each retail package of a product covered by this section is required to bear a statement that is prominently placed so that consumers are alerted to the tamper-resistant feature of the package. The labeling statement is also required to be so placed that it will be unaffected if the tamper-resistant feature of the package is breached or missing. If the tamper-resistant feature chosen to meet the requirement in paragraph (b) of this section is one that uses an identifying characteristic, that characteristic is required to be referred to in the labeling statement. For example, the labeling statement on a bottle with a shrink band could say “For your protection, this bottle has an imprinted seal around the neck.”

(d) *Requests for exemptions from packaging and labeling requirements.* A manufacturer or packer may request an exemption from the packaging and labeling requirements of this section. A request for an exemption is required to be submitted in the form of a citizen petition under §10.30 of this chapter and should be clearly identified on the envelope as a “Request for Exemption from Tamper-resistant Rule.” A petition for an exemption from a requirement of this section is required to contain the same kind of information about the product as is specified for OTC drugs in §211.132(d) of this chapter.

(e) *Products subject to approved premarket approval applications.* Holders of approved premarket approval applications for products subject to this section are required to submit supplements to provide for changes in packaging to comply with the requirement of paragraph (b) of this section unless these changes do not affect the composition of the container, the torque (tightness) of the container, or the composition of the closure component in contact with the contents (cap liner



or innerseal) as these features are described in the approved premarket approval application. Any supplemental premarket approval application under this paragraph is required to include data sufficient to show that these changes do not adversely affect the product.

(f) *Effective date.* Each product subject to this section is required to comply with the requirements of this section on the dates listed below except to the extent that a product's manufacturer or packer has obtained an exemption from a packaging or labeling requirement:

(1) *Initial effective date for packaging requirements.* (i) The packaging requirement in paragraph (b) of this section is effective on February 7, 1983 for each contact lens solution packaged for retail sale on or after that date, except for the requirement in paragraph (b) of this section for a distinctive indicator or barrier to entry.

(ii) The packaging requirement in paragraph (b) of this section is effective on May 5, 1983 for each tablet that is to be used to make a contact lens solution and that is packaged for retail sale on or after that date.

(2) *Initial effective date for labeling requirements.* The requirement in paragraph (b) of this section that the indicator or barrier to entry be distinctive by design and the requirement in paragraph (c) of this section for a labeling statement are effective on May 5, 1983 for each product subject to this section packaged for retail sale on or after that date, except that the requirement for a specific label reference to any identifying characteristic is effective on February 6, 1984 for each affected product subject to this section packaged for retail sale on or after that date.

(3) *Retail level effective date.* The tamper-resistant packaging requirement of paragraph (b) of this section is effective on February 6, 1984 for each product subject to this section that is held for sale at retail level on or after that date that was packaged for retail sale before May 5, 1983. This does not include the requirement in paragraph (b) of this section that the indicator or barrier to entry be distinctive by design. Products packaged for retail sale

after May 5, 1983, are required to be in compliance with all aspects of the regulations without regard to the retail level effective date.

[47 FR 50455, Nov. 5, 1982; 48 FR 1706, Jan. 14, 1983, as amended at 48 FR 16666, Apr. 19, 1983; 48 FR 37625, Aug. 19, 1983; 53 FR 11252, Apr. 6, 1988; 73 FR 34859, June 19, 2008]

EFFECTIVE DATE NOTE: A document published at 48 FR 41579, Sept. 16, 1983, stayed the effective date of § 800.12(f)(3) until further notice.

**§ 800.20 Patient examination gloves and surgeons' gloves; sample plans and test method for leakage defects; adulteration.**

(a) *Purpose.* The prevalence of human immunodeficiency virus (HIV), which causes acquired immune deficiency syndrome (AIDS), and its risk of transmission in the health care context, have caused the Food and Drug Administration (FDA) to look more closely at the quality control of barrier devices, such as surgeons' gloves and patient examination gloves (collectively known as medical gloves) to reduce the risk of transmission of HIV and other blood-borne infectious diseases. The Centers for Disease Control (CDC) recommend that health care workers wear medical gloves to reduce the risk of transmission of HIV and other blood-borne infectious diseases. The CDC recommends that health care workers wear medical gloves when touching blood or other body fluids, mucous membranes, or nonintact skin of all patients; when handling items or surfaces soiled with blood or other body fluids; and when performing venipuncture and other vascular access procedures. Among other things, CDC's recommendation that health care providers wear medical gloves demonstrates the proposition that devices labeled as medical gloves purport to be and are represented to be effective barriers against the transmission of blood- and fluid-borne pathogens. Therefore, FDA, through this regulation, is defining adulteration for patient examination and surgeons' gloves as a means of assuring safe and effective devices.

(1) For a description of a patient examination glove, see § 880.6250. Finger cots, however, are excluded from the

test method and sample plans in paragraphs (b) and (c) of this section.

(2) For a description of a surgeons' glove, see §878.4460 of this chapter.

(b)(1) *General test method.* For the purposes of this part, FDA's analysis of gloves for leaks and visual defects will be conducted by a visual examination and by a water leak test method, using 1,000 milliliters (ml) of water.

(i) *Units examined.* Each medical glove will be analyzed independently. When packaged as pairs, each glove is considered separately, and both gloves will be analyzed.

(ii) *Identification of defects.* For this test, defects include leaks detected when tested in accordance with paragraph (b)(3) of this section. A leak is defined as the appearance of water on the outside of the glove. This emergence of water from the glove constitutes a watertight barrier failure. Other defects include tears, embedded foreign objects, extrusions of glove material on the exterior or interior surface of the glove, gloves that are fused together so that individual glove separation is impossible, gloves that adhere to each other and tear when separated, or other visual defects that are likely to affect the barrier integrity.

(iii) *Factors for counting defects.* One defect in one glove is counted as one defect. A defect in both gloves in a pair of gloves is counted as two defects. If multiple defects, as defined in paragraph (b)(1)(ii) of this section, are found in one glove, they are counted as one defect. Visual defects and leaks that are observed in the top 40 millimeters (mm) of a glove will not be counted as a defect for the purposes of this part.

(2) *Leak test materials.* FDA considers the following to be the minimum materials required for this test :

(i) A 60 mm by 380 mm (clear) plastic cylinder with a hook on one end and a mark scored 40 mm from the other end (a cylinder of another size may be used if it accommodates both cuff diameter and any water above the glove capacity);

(ii) Elastic strapping with velcro or other fastening material;

(iii) Automatic water-dispensing apparatus or manual device capable of delivering 1,000 ml of water;

(iv) Stand with horizontal rod for hanging the hook end of the plastic tube. The horizontal support rod must be capable of holding the weight of the total number of gloves that will be suspended at any one time, e.g., five gloves suspended will weigh about 5 kilograms (kg);

(v) Timer capable of measuring two minute intervals.

(3) *Visual defects and leak test procedures.* Examine the sample and identify code/lot number, size, and brand as appropriate. Continue the visual examination using the following procedures:

(i) *Visual defects examination.* Inspect the gloves for visual defects by carefully removing the glove from the wrapper, box, or package. Visually examine each glove for defects. As noted in paragraph (b)(1)(iii) of this section, a visual defect observed in the top 40 mm of a glove will not be counted as a defect for the purpose of this part. Visually defective gloves do not require further testing, although they must be included in the total number of defective gloves counted for the sample.

(ii) *Leak test set-up.* (A) During this procedure, ensure that the exterior of the glove remains dry. Attach the glove to the plastic fill tube by bringing the cuff end to the 40 mm mark and fastening with elastic strapping to make a watertight seal.

(B) Add 1,000 ml of room temperature water (i.e., 20 (deg)C to 30 (deg)C) into the open end of the fill tube. The water should pass freely into the glove. (With some larger sizes of long-cuffed surgeons' gloves, the water level may reach only the base of the thumb. With some smaller gloves, the water level may extend several inches up the fill tube.)

(iii) *Leak test examination.* Immediately after adding the water, examine the glove for water leaks. Do not squeeze the glove; use only minimum manipulation to spread the fingers to check for leaks. Water drops may be blotted to confirm leaking.

(A) If the glove does not leak immediately, keep the glove/filling tube assembly upright and hang the assembly vertically from the horizontal rod, using the wire hook on the open end of the fill tube (do not support the filled glove while transferring).

**Food and Drug Administration, HHS**

**§ 800.20**

(B) Make a second observation for leaks 2 minutes after the water is added to the glove. Use only minimum manipulation of the fingers to check for leaks.

(C) Record the number of defective gloves.

(c) *Sampling, inspection, acceptance, and adulteration.* In performing the test for leaks and other visual defects described in paragraph (b) of this section, FDA will collect and inspect samples of medical gloves, and determine when the gloves are acceptable as set out in paragraphs (c)(1) through (c)(3) of this section.

(1) *Sample plans.* FDA will collect samples from lots of medical gloves in accordance with agency sampling plans. These plans are based on sample sizes, levels of sample inspection, and acceptable quality levels (AQLs) found in the International Standard Organization's standard ISO 2859, "Sampling Procedures For Inspection By Attributes."

(2) *Sample sizes, inspection levels, and minimum AQLs.* FDA will use single normal sampling for lots of 1,200 gloves or less and multiple normal sampling for all larger lots. FDA will use general inspection level II in determining the sample size for any lot size. As shown in the tables following paragraph (c)(3) of this section, FDA considers a 1.5 AQL to be the minimum level of quality acceptable for surgeons' gloves and a 2.5 AQL to be the minimum level of quality acceptable for patient examination gloves.

(3) *Adulteration levels and accept/reject criteria.* FDA considers a lot of medical gloves to be adulterated when the number of defective gloves found in the tested sample meets or exceeds the applicable rejection number at the 1.5 AQL for surgeons' gloves or the 2.5 AQL for patient examination gloves. These acceptance and rejection numbers are identified in the tables following paragraph (c)(3) of this section as follows:

**ACCEPT/REJECT CRITERIA AT 1.5 AQL FOR SURGEONS' GLOVES**

Lot Size	Sample	Sample Size	Number Examined	Number Defective	
				Accept	Reject
8 to 90	Single sample		8	0	1
91 to 280	Single sample		32	1	2
281 to 500	Single sample		50	2	3
501 to 1,200	Single sample		80	3	4
1,201 to 3,200	First	32	32	—	4
	Second	32	64	1	5
	Third	32	96	2	6
	Fourth	32	128	3	7
	Fifth	32	160	5	8
	Sixth	32	192	7	9
	Seventh	32	224	9	10
3,201 to 10,000	First	50	50	0	4
	Second	50	100	1	6
	Third	50	150	3	8
	Fourth	50	200	5	10
	Fifth	50	250	7	11
	Sixth	50	300	10	12
	Seventh	50	350	13	14
10,001 to 35,000	First	80	80	0	5
	Second	80	160	3	8
	Third	80	240	6	10
	Fourth	80	320	8	13
	Fifth	80	400	11	15
	Sixth	80	480	14	17
	Seventh	80	560	18	19
35,000	First	125	125	1	7
	Second	125	250	4	10
	Third	125	375	8	13
	Fourth	125	500	12	17
	Fifth	125	625	17	20

ACCEPT/REJECT CRITERIA AT 1.5 AQL FOR SURGEONS' GLOVES—Continued

Lot Size	Sample	Sample Size	Number Examined	Number Defective	
				Accept	Reject
	Sixth	125	750	21	23
	Seventh	125	875	25	26

ACCEPT/REJECT CRITERIA AT 2.5 AQL FOR PATIENT EXAMINATION GLOVES

Lot Size	Sample	Sample Size	Number Examined	Number Defective	
				Accept	Reject
5 to 50	Single sample		5	0	1
51 to 150	Single sample		20	1	2
151 to 280	Single sample		32	2	3
281 to 500	Single sample		50	3	4
501 to 1,200	Single sample		80	5	6
1,201 to 3,200	First	32	32	0	4
	Second	32	64	1	6
	Third	32	96	3	8
	Fourth	32	128	5	10
	Fifth	32	160	7	11
	Sixth	32	192	10	12
	Seventh	32	224	13	14
3,201 to 10,000	First	50	50	0	5
	Second	50	100	3	8
	Third	50	150	6	10
	Fourth	50	200	8	13
	Fifth	50	250	11	15
	Sixth	50	300	14	17
	Seventh	50	350	18	19
10,001 to 35,000	First	80	80	1	7
	Second	80	160	4	10
	Third	80	240	8	13
	Fourth	80	320	12	17
	Fifth	80	400	17	20
	Sixth	80	480	21	23
	Seventh	80	560	25	26
35,000 and above	First	125	125	2	9
	Second	125	250	7	14
	Third	125	375	13	19
	Fourth	125	500	19	25
	Fifth	125	625	25	29
	Sixth	125	750	31	33
	Seventh	125	875	37	38

(d) *Compliance.* Lots of gloves that are sampled, tested, and rejected using procedures in paragraphs (b) and (c) of this section, are considered adulterated within the meaning of section 501(c) of the act.

(1) *Detention and seizure.* Lots of gloves that are adulterated under section 501(c) of the act are subject to administrative and judicial action, such as detention of imported products and seizure of domestic products.

(2) *Reconditioning.* FDA may authorize the owner of the product, or the owner's representative, to attempt to recondition, i.e., bring into compliance with the act, a lot or part of a lot of foreign gloves detained at importation, or a lot or part of a lot of seized domestic gloves.

(i) *Modified sampling, inspection, and acceptance.* If FDA authorizes reconditioning of a lot or portion of a lot of adulterated gloves, testing to confirm that the reconditioned gloves meet

**Food and Drug Administration, HHS**

**§ 800.55**

AQLs must be performed by an independent testing facility. The following tightened sampling plan must be followed, as described in ISO 2859 “Sampling Procedures for Inspection by Attributes:”

- (A) General inspection level II,
- (B) Single sampling plans for tightened inspection,

- (C) 1.5 AQL for surgeons’ gloves, and
- (D) 2.5 AQL for patient examination gloves.

(ii) *Adulteration levels and acceptance criteria for reconditioned gloves.* (A) FDA considers a lot or part of a lot of adulterated gloves, that is reconditioned in

accordance with paragraph (d)(2)(i) of this section, to be acceptable when the number of defective gloves found in the tested sample does not exceed the acceptance number in the appropriate tables in paragraph (d)(2)(ii)(B) of this section for reconditioned surgeons’ gloves or patient examination gloves.

(B) FDA considers a reconditioned lot of medical gloves to be adulterated within the meaning of section 501(c) of the act when the number of defective gloves found in the tested sample meets or exceeds the applicable rejection number in the tables following paragraph (d)(2)(ii)(B) of this section:

ACCEPT/REJECT CRITERIA AT 1.5 AQL FOR RECONDITIONED SURGEONS’ GLOVES

Lot Size	Sample	Sample Size	Number Defective	
			Accept	Reject
13 to 90	Single sample	13	0	1
91 to 500	Single sample	50	1	2
501 to 1,200	Single sample	80	2	3
1,201 to 3,200	Single sample	125	3	4
3,201 to 10,000	Single sample	200	5	6
10,001 to 35,000	Single sample	315	8	9
35,000 and above	Single sample	500	12	13

ACCEPT/REJECT CRITERIA AT 2.5 AQL FOR RECONDITIONED PATIENT EXAMINATION GLOVES

Lot Size	Sample	Sample Size	Number Defective	
			Accept	Reject
8 to 50	Single sample	8	0	1
51 to 280	Single sample	32	1	2
281 to 500	Single sample	50	2	3
501 to 1,200	Single sample	80	3	4
1,201 to 3,200	Single sample	125	5	6
3,201 to 10,000	Single sample	200	8	9
10,001 to 35,000	Single sample	315	12	13
35,000 and above	Single sample	500	18	19

[55 FR 51256, Dec. 12, 1990, as amended at 71 FR 75876, Dec. 19, 2006]

**Subpart C—Administrative Practices and Procedures**

**§ 800.55 Administrative detention.**

(a) *General.* This section sets forth the procedures for detention of medical devices intended for human use believed to be adulterated or misbranded.

Administrative detention is intended to protect the public by preventing distribution or use of devices encountered during inspections that may be adulterated or misbranded, until the Food and Drug Administration (FDA) has had time to consider what action it should take concerning the devices, and to initiate legal action, if appropriate. Devices that FDA orders detained may not be used, moved, altered, or tampered with in any manner by any person during the detention period, except as authorized under paragraph (h) of this section, until FDA terminates the detention order under paragraph (j) of this section, or the detention period expires, whichever occurs first.

(b) *Criteria for ordering detention.* Administrative detention of devices may be ordered in accordance with this section when an authorized FDA representative, during an inspection under section 704 of the Federal Food, Drug, and Cosmetic Act (the act), has reason to believe that a device, as defined in section 201(h) of the act, is adulterated or misbranded.

(c) *Detention period.* The detention is to be for a reasonable period that may not exceed 20 calendar days after the detention order is issued, unless the FDA Division Director in whose division the devices are located determines that a greater period is required to seize the devices, to institute injunction proceedings, or to evaluate the need for legal action, in which case the Division Director may authorize detention for 10 additional calendar days. The additional 10-calendar-day detention period may be ordered at the time the detention order is issued or at any time thereafter. The entire detention period may not exceed 30 calendar days, except when the detention period is extended under paragraph (g)(6) of this section. An authorized FDA representative may, in accordance with paragraph (j) of this section, terminate a detention before the expiration of the detention period.

(d) *Issuance of detention order.* (1) The detention order shall be issued in writing, in the form of a detention notice, signed by the authorized FDA representative who has reason to believe that the devices are adulterated or

misbranded, and issued to the owner, operator, or agent in charge of the place where the devices are located. If the owner or the user of the devices is different from the owner, operator, or agent in charge of the place where the devices are detained, a copy of the detention order shall be provided to the owner or user of the devices if the owner's or user's identity can be readily determined.

(2) If detention of devices in a vehicle or other carrier is ordered, a copy of the detention order shall be provided to the shipper of record and the owner of the vehicle or other carrier, if their identities can be readily determined.

(3) The detention order shall include the following information:

(i) A statement that the devices identified in the order are detained for the period shown;

(ii) A brief, general statement of the reasons for the detention;

(iii) The location of the devices;

(iv) A statement that these devices are not to be used, moved, altered, or tampered with in any manner during that period, except as permitted under paragraph (h) of this section, without the written permission of an authorized FDA representative;

(v) Identification of the detained devices;

(vi) The detention order number;

(vii) The date and hour of the detention order;

(viii) The period of the detention;

(ix) The text of section 304(g) of the act and paragraph (g) (1) and (2) of this section;

(x) A statement that any informal hearing on an appeal of a detention order shall be conducted as a regulatory hearing under part 16 of this chapter, with certain exceptions described in paragraph (g)(3) of this section; and

(xi) The mailing address, telephone number, and name of the FDA Division Director.

(e) *Approval of detention order.* A detention order, before issuance, shall be approved by the FDA Division Director in whose division the devices are located. If prior written approval is not feasible, prior oral approval shall be obtained and confirmed by written

memorandum within FDA as soon as possible.

(f) *Labeling or marking a detained device.* An FDA representative issuing a detention order under paragraph (d) of this section shall label or mark the devices with official FDA tags that include the following information:

(1) A statement that the devices are detained by the United States Government in accordance with section 304(g) of the Federal Food, Drug, and Cosmetic Act (21 U.S.C. 334(g)).

(2) A statement that the devices shall not be used, moved, altered, or tampered with in any manner for the period shown, without the written permission of an authorized FDA representative, except as authorized in paragraph (h) of this section.

(3) A statement that the violation of a detention order or the removal or alteration of the tag is punishable by fine or imprisonment or both (section 303 of the act, 21 U.S.C. 333).

(4) The detention order number, the date and hour of the detention order, the detention period, and the name of the FDA representative who issued the detention order.

(g) *Appeal of a detention order.* (1) A person who would be entitled to claim the devices, if seized, may appeal a detention order. Any appeal shall be submitted in writing to the FDA Division Director in whose division the devices are located within 5 working days of receipt of a detention order. If the appeal includes a request for an informal hearing, as defined in section 201(x) of the act, the appellant shall request either that a hearing be held within 5 working days after the appeal is filed or that the hearing be held at a later date, which shall not be later than 20 calendar days after receipt of a detention order.

(2) The appellant of a detention order shall state the ownership or proprietary interest the appellant has in the detained devices. If the detained devices are located at a place other than an establishment owned or operated by the appellant, the appellant shall include documents showing that the appellant would have legitimate authority to claim the devices if seized.

(3) Any informal hearing on an appeal of a detention order shall be con-

ducted as a regulatory hearing pursuant to regulation in accordance with part 16 of this chapter, except that:

(i) The detention order under paragraph (d) of this section, rather than the notice under §16.22(a) of this chapter, provides notice of opportunity for a hearing under this section and is part of the administrative record of the regulatory hearing under §16.80(a) of this chapter.

(ii) A request for a hearing under this section should be addressed to the FDA Division Director.

(iii) The last sentence of §16.24(e) of this chapter, stating that a hearing may not be required to be held at a time less than 2 working days after receipt of the request for a hearing, does not apply to a hearing under this section.

(iv) Paragraph (g)(4) of this section, rather than §16.42(a) of this chapter, describes the FDA employees who preside at hearings under this section.

(4) The presiding officer of a regulatory hearing on an appeal of a detention order, who also shall decide the appeal, shall be an Office of Regulatory Affairs Program Director or another FDA official senior to an FDA Division Director who is permitted by §16.42(a) of this chapter to preside over the hearing.

(5) If the appellant requests a regulatory hearing and requests that the hearing be held within 5 working days after the appeal is filed, the presiding officer shall, within 5 working days, hold the hearing and render a decision affirming or revoking the detention.

(6) If the appellant requests a regulatory hearing and requests that the hearing be held at a date later than within 5 working days after the appeal is filed, but not later than 20 calendar days after receipt of a detention order, the presiding officer shall hold the hearing at a date agreed upon by FDA and the appellant. The presiding officer shall decide whether to affirm or revoke the detention within 5 working days after the conclusion of the hearing. The detention period extends to the date of the decision even if the 5-working-day period for making the decision extends beyond the otherwise applicable 20-calendar-day or 30-calendar-day detention period.

(7) If the appellant appeals the detention order but does not request a regulatory hearing, the presiding officer shall render a decision on the appeal affirming or revoking the detention within 5 working days after the filing of the appeal.

(8) If the presiding officer affirms a detention order, the devices continue to be detained until FDA terminates the detention under paragraph (j) of this section or the detention period expires, whichever occurs first.

(9) If the presiding officer revokes a detention order, FDA shall terminate the detention under paragraph (j) of this section.

(h) *Movement of detained devices.* (1) Except as provided in this paragraph (h), no person shall move detained devices within or from the place where they have been ordered detained until FDA terminates the detention under paragraph (j) of this section or the detention period expires, whichever occurs first.

(2) If detained devices are not in final form for shipment, the manufacturer may move them within the establishment where they are detained to complete the work needed to put them in final form. As soon as the devices are moved for the purpose of the preceding sentence, the individual responsible for their movement shall orally notify the FDA representative who issued the detention order, or another responsible division office official, of the movement of the devices. As soon as the devices are put in final form, they shall be segregated from other devices, and the individual responsible for their movement shall orally notify the FDA representative who issued the detention order, or another responsible division office official, of their new location. The devices put in final form shall not be moved further without FDA approval.

(3) The FDA representative who issued the detention order, or another responsible division office official, may approve, in writing, the movement of detained devices for any of the following purposes:

(i) To prevent interference with an establishment's operations or harm to the devices.

(ii) To destroy the devices.

(iii) To bring the devices into compliance.

(iv) For any other purpose that the FDA representative who issued the detention order, or other responsible division office official, believes is appropriate in the case.

(4) If an FDA representative approves the movement of detained devices under paragraph (h)(3) of this section, the detained devices shall remain segregated from other devices and the person responsible for their movement shall immediately orally notify the official who approved the movement of the devices, or another responsible FDA division office official, of the new location of the detained devices.

(5) Unless otherwise permitted by the FDA representative who is notified of, or who approves, the movement of devices under this paragraph, the required tags shall accompany the devices during and after movement and shall remain with the devices until FDA terminates the detention or the detention period expires, whichever occurs first.

(i) *Actions involving adulterated or misbranded devices.* If FDA determines that the detained devices, including any that have been put in final form, are adulterated or misbranded, or both, it may initiate legal action against the devices or the responsible individuals, or both, or request that the devices be destroyed or otherwise brought into compliance with the act under FDA's supervision.

(j) *Detention termination.* If FDA decides to terminate a detention or when the detention period expires, whichever occurs first, an FDA representative authorized to terminate a detention will issue a detention termination notice releasing the devices to any person who received the original detention order or that person's representative and will remove, or authorize in writing the removal of, the required labels or tags.

(k) *Recordkeeping requirements.* (1) After issuance of a detention order under paragraph (d) of this section, the owner, operator, or agent in charge of any factory, warehouse, other establishment, or consulting laboratory where detained devices are manufactured, processed, packed, or held shall



have, or establish, and maintain adequate records relating to how the detained devices may have become adulterated or misbranded, records on any distribution of the devices before and after the detention period, records on the correlation of any in-process detained devices that are put in final form under paragraph (h) of this section to the completed devices, records of any changes in, or processing of, the devices permitted under the detention order, and records of any other movement under paragraph (h) of this section. Records required under this paragraph shall be provided to the FDA on request for review and copying. Any FDA request for access to records required under this paragraph shall be made at a reasonable time, shall state the reason or purpose for the request, and shall identify to the fullest extent practicable the information or type of information sought in the records to which access is requested.

(2) Records required under this paragraph shall be maintained for a maximum period of 2 years after the issuance of the detention order or for such other shorter period as FDA directs. When FDA terminates the detention or when the detention period expires, whichever occurs first, FDA will advise all persons required under this paragraph to keep records concerning that detention whether further recordkeeping is required for the remainder of the 2-year, or shorter, period. FDA ordinarily will not require further recordkeeping if the agency determines that the devices are not adulterated or misbranded or that recordkeeping is not necessary to protect the public health, unless the records are required under other regulations in this chapter (e.g., the good manufacturing practice regulation in part 820 of this chapter).

[44 FR 13239, Mar. 9, 1979, as amended at 49 FR 3174, Jan. 26, 1984; 69 FR 17292, Apr. 2, 2004; 79 FR 9412, Feb. 19, 2014; 82 FR 14147, Mar. 17, 2017; 85 FR 16555, Mar. 25, 2020]

**§ 800.75 Requests for supervisory review of certain decisions made by the Center for Devices and Radiological Health.**

(a) *Definitions.* The following definitions shall apply to this section:

(1) *FDA* means the Food and Drug Administration.

(2) *517A decision* means a significant decision made by the Center for Devices and Radiological Health, as set forth in section 517A of the Federal Food, Drug, and Cosmetic Act, and includes one of the following decisions:

(i) A substantially equivalent order under § 807.100(a)(1) of this chapter, or a not substantially equivalent order under § 807.100(a)(2) of this chapter;

(ii) An approval order under § 814.44(d) of this chapter, an approvable letter under § 814.44(e) of this chapter, a not approvable letter under § 814.44(f) of this chapter, or an order denying approval under § 814.45 of this chapter;

(iii) An approval order under § 814.116(b) of this chapter, an approvable letter under § 814.116(c) of this chapter, a not approvable letter under § 814.116(d) of this chapter, or an order denying approval under § 814.118 of this chapter;

(iv) A grant or denial of a request for breakthrough device designation under section 515B of the Federal Food, Drug, and Cosmetic Act;

(v) An approval order under § 812.30(a) of this chapter or a disapproval order under § 812.30(c) of this chapter;

(vi) A failure to reach agreement letter under section 520(g)(7) of the Federal Food, Drug, and Cosmetic Act; or

(vii) A clinical hold determination under section 520(g)(8) of the Federal Food, Drug, and Cosmetic Act.

(3) *CDRH* means the Center for Devices and Radiological Health.

(b) *Submission of request—(1) Review of 517A decisions.* (i) An initial or sequential request for supervisory review within CDRH of a 517A decision under § 10.75 of this chapter must be addressed to the next organizational level or higher above the individual who made the decision; submitted in electronic format in accordance with section 745A(b) of the Federal Food, Drug, and Cosmetic Act; marked “Appeal: Request for Supervisory Review”; and received by CDRH no later than 30 days after the date of the decision involved. Any such request for supervisory review not received by CDRH within 30 days after the date of the decision involved is not eligible for review. Except as provided in paragraph (b)(1)(ii) or

(iii) of this section, FDA will render a decision within 45 days of the request for supervisory review.

(ii) A person requesting supervisory review under paragraph (b)(1)(i) may request an in-person meeting or teleconference with the supervisor reviewing the request for supervisory review. Except as provided in paragraph (b)(1)(iii) of this section, if a request for in-person meeting or teleconference is included in the request for supervisory review to CDRH, CDRH will schedule the meeting or teleconference to occur within 30 days of receipt of the request. Except as provided in paragraph (b)(1)(iii) of this section, a decision will be rendered within 30 days of such meeting or teleconference.

(iii) The timeframes for CDRH to render a decision provided in (b)(1)(i) and (ii) of this section, and the timeframe to schedule an in-person meeting or teleconference review in (b)(1)(ii) of this section, do not apply if a matter related to the 517A decision under review is referred by CDRH to external experts, such as an advisory committee, as provided in §10.75(b) of this chapter.

(2) *Supervisory review.* An initial or sequential request for supervisory review within CDRH under §10.75 of this chapter of a decision other than a 517A decision that is not received by CDRH within 60 days after the date of the decision involved will be denied as untimely, unless CDRH, for good cause, permits the request to be filed after 60 days. An initial or sequential request for supervisory review within CDRH of a decision other than a 517A decision must be addressed to the next organizational level or higher above the individual who made the decision; submitted in electronic format in accordance with section 745A(b) of the Federal Food, Drug, and Cosmetic Act, when applicable; marked, “Appeal: Request for Supervisory Review” in the subject line of the electronic request; and sent to the CDRH Ombudsman at [CDRHombudsman@fda.hhs.gov](mailto:CDRHombudsman@fda.hhs.gov).

[84 FR 31477, July 2, 2019]

## PART 801—LABELING

### Subpart A—General Labeling Provisions

#### Sec.

- 801.1 Medical devices; name and place of business of manufacturer, packer or distributor.
- 801.3 Definitions.
- 801.4 Meaning of *intended uses*.
- 801.5 Medical devices; adequate directions for use.
- 801.6 Medical devices; misleading statements.
- 801.15 Medical devices; prominence of required label statements.
- 801.16 Medical devices; Spanish-language version of certain required statements.
- 801.18 Format of dates provided on a medical device label.

### Subpart B—Labeling Requirements for Unique Device Identification

- 801.20 Label to bear a unique device identifier.
- 801.30 General exceptions from the requirement for the label of a device to bear a unique device identifier.
- 801.35 Voluntary labeling of a device with a unique device identifier.
- 801.40 Form of a unique device identifier.
- 801.45 Devices that must be directly marked with a unique device identifier.
- 801.50 Labeling requirements for stand-alone software.
- 801.55 Request for an exception from or alternative to a unique device identifier requirement.
- 801.57 Discontinuation of legacy FDA identification numbers assigned to devices.

### Subpart C—Labeling Requirements for Over-the-Counter Devices

- 801.60 Principal display panel.
- 801.61 Statement of identity.
- 801.62 Declaration of net quantity of contents.
- 801.63 Medical devices; warning statements for devices containing or manufactured with chlorofluorocarbons and other class I ozone-depleting substances.

### Subpart D—Exemptions From Adequate Directions for Use

- 801.109 Prescription devices.
- 801.110 Retail exemption for prescription devices.
- 801.116 Medical devices having commonly known directions.
- 801.119 In vitro diagnostic products.
- 801.122 Medical devices for processing, repackaging, or manufacturing.
- 801.125 Medical devices for use in teaching, law enforcement, research, and analysis.

## Food and Drug Administration, HHS

## § 801.3

- 801.127 Medical devices; expiration of exemptions.
- 801.128 Exceptions or alternatives to labeling requirements for medical devices held by the Strategic National Stockpile.

### Subpart E—Other Exemptions

- 801.150 Medical devices; processing, labeling, or repacking.

### Subparts F–G [Reserved]

### Subpart H—Special Requirements for Specific Devices

- 801.405 Labeling of articles intended for lay use in the repairing and/or refitting of dentures.
- 801.410 Use of impact-resistant lenses in eyeglasses and sunglasses.
- 801.415 Maximum acceptable level of ozone.
- 800.417 Chlorofluorocarbon propellants.
- 801.420 Hearing aid devices; professional and patient labeling.
- 801.421 Hearing aid devices; conditions for sale.
- 801.430 User labeling for menstrual tampons.
- 801.433 Warning statements for prescription and restricted device products containing or manufactured with chlorofluorocarbons or other ozone-depleting substances.
- 801.435 User labeling for latex condoms.
- 801.437 User labeling for devices that contain natural rubber.

AUTHORITY: 21 U.S.C. 321, 331, 351, 352, 360d, 360i, 360j, 371, 374.

SOURCE: 41 FR 6896, Feb. 13, 1976, unless otherwise noted.

### Subpart A—General Labeling Provisions

#### § 801.1 Medical devices; name and place of business of manufacturer, packer or distributor.

(a) The label of a device in package form shall specify conspicuously the name and place of business of the manufacturer, packer, or distributor.

(b) The requirement for declaration of the name of the manufacturer, packer, or distributor shall be deemed to be satisfied, in the case of a corporation, only by the actual corporate name which may be preceded or followed by the name of the particular division of the corporation. Abbreviations for “Company,” “Incorporated,” etc., may be used and “The” may be omitted. In the case of an individual, partnership,

or association, the name under which the business is conducted shall be used.

(c) Where a device is not manufactured by the person whose name appears on the label, the name shall be qualified by a phrase that reveals the connection such person has with such device; such as, “Manufactured for \_\_\_\_\_”, “Distributed by \_\_\_\_\_”, or any other wording that expresses the facts.

(d) The statement of the place of business shall include the street address, city, State, and Zip Code; however, the street address may be omitted if it is shown in a current city directory or telephone directory. The requirement for inclusion of the ZIP Code shall apply only to consumer commodity labels developed or revised after the effective date of this section. In the case of nonconsumer packages, the ZIP Code shall appear on either the label or the labeling (including the invoice).

(e) If a person manufactures, packs, or distributes a device at a place other than his principal place of business, the label may state the principal place of business in lieu of the actual place where such device was manufactured or packed or is to be distributed, unless such statement would be misleading.

#### § 801.3 Definitions.

As used in this part:

*Automatic identification and data capture (AIDC)* means any technology that conveys the unique device identifier or the device identifier of a device in a form that can be entered into an electronic patient record or other computer system via an automated process.

*Center Director* means the Director of the Center for Devices and Radiological Health or the Director of the Center for Biologics Evaluation and Research, depending on which Center has been assigned lead responsibility for the device.

*Combination product* has the meaning set forth in § 3.2(e) of this chapter.

*Convenience kit* means two or more different medical devices packaged together for the convenience of the user.

*Device package* means a package that contains a fixed quantity of a particular version or model of a device.

*Expiration date* means the date by which the label of a device states the device must or should be used.

*FDA, we, or us* means the Food and Drug Administration.

*Finished device* means any device or accessory to any device that is suitable for use or capable of functioning.

*Global Unique Device Identification Database (GUDID)* means the database that serves as a repository of information to facilitate the identification of medical devices through their distribution and use.

*Human cells, tissues, or cellular or tissue-based product (HCT/P) regulated as a device* means an HCT/P as defined in § 1271.3(d) of this chapter that does not meet the criteria in § 1271.10(a) and that is also regulated as a device.

*Implantable device* means a device that is intended to be placed in a surgically or naturally formed cavity of the human body. A device is regarded as an *implantable device* for the purpose of this part only if it is intended to remain implanted continuously for a period of 30 days or more, unless the Commissioner of Food and Drugs determines otherwise in order to protect human health.

*Label* has the meaning set forth in section 201(k) of the Federal Food, Drug, and Cosmetic Act.

*Labeler* means:

(1) Any person who causes a label to be applied to a device with the intent that the device will be commercially distributed without any intended subsequent replacement or modification of the label; and

(2) Any person who causes the label of a device to be replaced or modified with the intent that the device will be commercially distributed without any subsequent replacement or modification of the label, except that the addition of the name of, and contact information for, a person who distributes the device, without making any other changes to the label, is not a modification for the purposes of determining whether a person is a labeler.

*Lot or batch* means one *finished device* or more that consist of a single type, model, class, size, composition, or software version that are manufactured under essentially the same conditions and that are intended to have uniform

characteristics and quality within specified limits.

*Shipping container* means a container used during the shipment or transportation of devices, and whose contents may vary from one shipment to another.

*Specification* means any requirement with which a device must conform.

*Unique device identifier (UDI)* means an identifier that adequately identifies a device through its distribution and use by meeting the requirements of § 830.20 of this chapter. A unique device identifier is composed of:

(1) A *device identifier*—a mandatory, fixed portion of a UDI that identifies the specific version or model of a device and the labeler of that device; and

(2) A *production identifier*—a conditional, variable portion of a UDI that identifies one or more of the following when included on the label of the device:

(i) The lot or batch within which a device was manufactured;

(ii) The serial number of a specific device;

(iii) The expiration date of a specific device;

(iv) The date a specific device was manufactured;

(v) For an HCT/P regulated as a device, the distinct identification code required by § 1271.290(c) of this chapter.

*Universal product code (UPC)* means the product identifier used to identify an item sold at retail in the United States.

*Version or model* means all devices that have specifications, performance, size, and composition, within limits set by the labeler.

[78 FR 58817, Sept. 24, 2013]

#### § 801.4 Meaning of *intended uses*.

The words *intended uses* or words of similar import in §§ 801.5, 801.119, and 801.122 refer to the objective intent of the persons legally responsible for the labeling of devices. The intent is determined by such persons' expressions or may be shown by the circumstances surrounding the distribution of the article. This objective intent may, for example, be shown by labeling claims, advertising matter, or oral or written statements by such persons or their representatives. It may be shown by

the circumstances that the article is, with the knowledge of such persons or their representatives, offered and used for a purpose for which it is neither labeled nor advertised. The intended uses of an article may change after it has been introduced into interstate commerce by its manufacturer. If, for example, a packer, distributor, or seller intends an article for different uses than those intended by the person from whom he received the devices, such packer, distributor, or seller is required to supply adequate labeling in accordance with the new intended uses. But if a manufacturer knows, or has knowledge of facts that would give him notice that a device introduced into interstate commerce by him is to be used for conditions, purposes, or uses other than the ones for which he offers it, he is required to provide adequate labeling for such a device which accords with such other uses to which the article is to be put.

EFFECTIVE DATE NOTE: At 82 FR 2217, Jan. 9, 2017, § 801.4 was revised, effective Feb. 8, 2017. At 82 FR 9501, Feb. 7, 2017, this amendment was delayed until Mar. 21, 2017. At 82 FR 14319, Mar. 20, 2017, this amendment was further delayed until Mar. 19, 2018. At 83 FR 11639, Mar. 16, 2018 this amendment was delayed indefinitely. For the convenience of the user, the revised text is set forth as follows:

**§ 801.4 Meaning of intended uses.**

The words *intended uses* or words of similar import in §§ 801.5, 801.119, 801.122, and 1100.5 of this chapter refer to the objective intent of the persons legally responsible for the labeling of devices. The intent is determined by such persons' expressions or may be shown by the circumstances surrounding the distribution of the article. This objective intent may, for example, be shown by labeling claims, advertising matter, or oral or written statements by such persons or their representatives. It may be shown, for example, by circumstances in which the article is, with the knowledge of such persons or their representatives, offered and used for a purpose for which it is neither labeled nor advertised. The intended uses of an article may change after it has been introduced into interstate commerce by its manufacturer. If, for example, a packer, distributor, or seller intends an article for different uses than those intended by the person from whom he received the device, such packer, distributor, or seller is required to supply adequate labeling in accordance with the new intended uses. And if the totality of the evidence es-

tablishes that a manufacturer objectively intends that a device introduced into interstate commerce by him is to be used for conditions, purposes, or uses other than ones for which it has been approved, cleared, granted marketing authorization, or is exempt from premarket notification requirements (if any), he is required, in accordance with section 502(f) of the Federal Food, Drug, and Cosmetic Act, or, as applicable, duly promulgated regulations exempting the device from the requirements of section 502(f)(1), to provide for such device adequate labeling that accords with such other intended uses.

**§ 801.5 Medical devices; adequate directions for use.**

*Adequate directions for use* means directions under which the layman can use a device safely and for the purposes for which it is intended. Section 801.4 defines *intended use*. Directions for use may be inadequate because, among other reasons, of omission, in whole or in part, or incorrect specification of:

(a) Statements of all conditions, purposes, or uses for which such device is intended, including conditions, purposes, or uses for which it is prescribed, recommended, or suggested in its oral, written, printed, or graphic advertising, and conditions, purposes, or uses for which the device is commonly used; except that such statements shall not refer to conditions, uses, or purposes for which the device can be safely used only under the supervision of a practitioner licensed by law and for which it is advertised solely to such practitioner.

(b) Quantity of dose, including usual quantities for each of the uses for which it is intended and usual quantities for persons of different ages and different physical conditions.

(c) Frequency of administration or application.

(d) Duration of administration or application.

(e) Time of administration or application, in relation to time of meals, time of onset of symptoms, or other time factors.

(f) Route or method of administration or application.

(g) Preparation for use, i.e., adjustment of temperature, or other manipulation or process.

## § 801.6

## 21 CFR Ch. I (4–1–20 Edition)

### § 801.6 Medical devices; misleading statements.

Among representations in the labeling of a device which render such device misbranded is a false or misleading representation with respect to another device or a drug or food or cosmetic.

### § 801.15 Medical devices; prominence of required label statements; use of symbols in labeling.

(a) A word, statement, or other information required by or under authority of the act to appear on the label may lack that prominence and conspicuousness required by section 502(c) of the act by reason, among other reasons, of:

(1) The failure of such word, statement, or information to appear on the part or panel of the label which is presented or displayed under customary conditions of purchase;

(2) The failure of such word, statement, or information to appear on two or more parts or panels of the label, each of which has sufficient space therefor, and each of which is so designed as to render it likely to be, under customary conditions of purchase, the part or panel displayed;

(3) The failure of the label to extend over the area of the container or package available for such extension, so as to provide sufficient label space for the prominent placing of such word, statement, or information;

(4) Insufficiency of label space for the prominent placing of such word, statement, or information, resulting from the use of label space for any word, statement, design, or device which is not required by or under authority of the act to appear on the label;

(5) Insufficiency of label space for the placing of such word, statement, or information, resulting from the use of label space to give materially greater conspicuousness to any other word, statement, or information, or to any design or device; or

(6) Smallness or style of type in which such word, statement, or information appears, insufficient background contrast, obscuring designs or vignettes, or crowding with other written, printed, or graphic matter.

(b) No exemption depending on insufficiency of label space, as prescribed in

regulations promulgated under section 502(b) of the act, shall apply if such insufficiency is caused by:

(1) The use of label space for any word, statement, design, or device which is not required by or under authority of the act to appear on the label;

(2) The use of label space to give greater conspicuousness to any word, statement, or other information than is required by section 502(c) of the act; or

(3) The use of label space for any representation in a foreign language.

(c)(1)(i) All words, statements, and other information required by or under authority of the act to appear on the label or labeling for a device shall appear thereon in one or more of the following formats:

(A) The English language;

(B) In the case of articles distributed solely in Puerto Rico or in a Territory where the predominant language is one other than English, the predominant language may be substituted for English;

(C) A symbol accompanied by adjacent explanatory English text, or text in the predominant language of the Territory, in the case of articles distributed solely in Puerto Rico or in a Territory where the predominant language is one other than English;

(D) A symbol not accompanied by adjacent explanatory text that:

(1) Is contained in a standard that FDA recognizes under its authority in section 514(c) of the act;

(2) Is used according to the specifications for use of the symbol set forth in FDA's section 514(c) recognition; and

(3) Is explained in a paper or electronic symbols glossary that is included in the labeling for the device and the labeling on or within the package containing the device bears a prominent and conspicuous statement identifying the location of the symbols glossary that is written in English or, in the case of articles distributed solely in Puerto Rico or in a Territory where the predominant language is one other than English, the predominant language may be used;

(E) A symbol not accompanied by adjacent explanatory text that:

(1) Is established in a standard developed by a standards development organization (SDO);

(2) Is not contained in a standard that is recognized by FDA under its authority in section 514(c) of the act or is contained in a standard that is recognized by FDA but is not used according to the specifications for use of the symbol set forth in FDA's section 514(c) recognition;

(3) Is determined by the manufacturer to be likely to be read and understood by the ordinary individual under customary conditions of purchase and use in compliance with section 502(c) of the act;

(4) Is used according to the specifications for use of the symbol set forth in the SDO-developed standard; and

(5) Is explained in a paper or electronic symbols glossary that is included in the labeling for the device and the labeling on or within the package containing the device bears a prominent and conspicuous statement identifying the location of the symbols glossary that is written in English or, in the case of articles distributed solely in Puerto Rico or in a Territory where the predominant language is one other than English, the predominant language may be used;

(F) The symbol statement "Rx only" or "R only" may be used as provided under § 801.109(b)(1).

(ii) The use of symbols in device labeling which do not meet the requirements of paragraph (c)(1)(i) of this section renders a device misbranded under section 502(c) of the act.

(iii) For purposes of paragraph (c)(1)(i) of this section:

(A) An SDO is an organization that is nationally or internationally recognized and that follows a process for standard development that is transparent, (*i.e.*, open to public scrutiny), where the participation is balanced, where an appeals process is included, where the standard is not in conflict with any statute, regulation, or policy under which FDA operates, and where the standard is national or international in scope.

(B) The term "symbols glossary" means a compiled listing of:

(1) Each SDO-established symbol used in the labeling for the device;

(2) The title and designation number of the SDO-developed standard containing the symbol;

(3) The title of the symbol and its reference number, if any, in the standard; and

(4) The meaning or explanatory text for the symbol as provided in the FDA recognition or, if FDA has not recognized the standard or portion of the standard in which the symbol is located or the symbol is not used according to the specifications for use of the symbol set forth in FDA's section 514(c) recognition, the explanatory text as provided in the standard.

(2) If the label contains any representation in a foreign language, all words, statements, and other information required by or under authority of the act to appear on the label shall appear thereon in the foreign language.

(3) If the labeling contains any representation in a foreign language, all words, statements, and other information required by or under authority of the act to appear on the label or labeling shall appear on the labeling in the foreign language.

[41 FR 6896, Feb. 13, 1976, as amended at 81 FR 38930, June 15, 2016]

**§ 801.16 Medical devices; Spanish-language version of certain required statements.**

If devices restricted to prescription use only are labeled solely in Spanish for distribution in the Commonwealth of Puerto Rico where Spanish is the predominant language, such labeling is authorized under § 801.15(c).

**§ 801.18 Format of dates provided on a medical device label.**

(a) *In general.* Whenever the label of a medical device includes a printed expiration date, date of manufacture, or any other date intended to be brought to the attention of the user of the device, the date must be presented in the following format: The year, using four digits; followed by the month, using two digits; followed by the day, using two digits; each separated by hyphens. For example, January 2, 2014, must be presented as 2014-01-02.

(b) *Exceptions.* (1) A combination product that properly bears a National Drug Code (NDC) number is not subject

## § 801.20

## 21 CFR Ch. I (4–1–20 Edition)

to the requirements of paragraph (a) of this section.

(2) If the device is an electronic product to which a standard is applicable under subchapter J of this chapter, Radiological Health, the date of manufacture shall be presented as required by § 1010.3(a)(2)(ii) of this chapter.

[78 FR 58818, Sept. 24, 2013]

### Subpart B—Labeling Requirements for Unique Device Identification

#### § 801.20 Label to bear a unique device identifier.

(a) *In general.* (1) The label of every medical device shall bear a unique device identifier (UDI) that meets the requirements of this subpart and part 830 of this chapter.

(2) Every device package shall bear a UDI that meets the requirements of this subpart and part 830 of this chapter.

(b) *Exceptions.* Exceptions to the general rule of paragraph (a) of this section are provided by §§ 801.30, 801.45, and 801.128(f)(2), and § 801.55 provides a means to request an exception or alternative not provided by those provisions.

[78 FR 58818, Sept. 24, 2013]

#### § 801.30 General exceptions from the requirement for the label of a device to bear a unique device identifier.

(a) *In general.* The following types of devices are excepted from the requirement of § 801.20; a device within one or more of the following exceptions is not required to bear a unique device identifier (UDI):

(1) A finished device manufactured and labeled prior to the compliance date established by FDA for § 801.20 regarding the device. This exception expires with regard to a particular device 3 years after the compliance date established by FDA for the device.

(2) A class I device that FDA has by regulation exempted from the good manufacturing practice requirements of part 820 of this chapter, exclusive of any continuing requirement for record-keeping under §§ 820.180 and 820.198.

(3) Individual single-use devices, all of a single version or model, that are

distributed together in a single device package, intended to be stored in that device package until removed for use, and which are not intended for individual commercial distribution. This exception is not available for any implantable device. The device package containing these individual devices is not excepted from the requirement of § 801.20, and must bear a UDI.

(4) A device used solely for research, teaching, or chemical analysis, and not intended for any clinical use.

(5) A custom device within the meaning of § 812.3(b) of this chapter.

(6) An investigational device within the meaning of part 812 of this chapter.

(7) A veterinary medical device not intended for use in the diagnosis of disease or other conditions in man, in the cure, mitigation, treatment, or prevention of disease in man, or intended to affect the structure or any function of the body of man.

(8) A device intended for export from the United States.

(9) A device held by the Strategic National Stockpile and granted an exception or alternative under § 801.128(f)(2).

(10) A device for which FDA has established a performance standard under section 514(b) of the Federal Food, Drug, and Cosmetic Act and has provided therein an exception from the requirement of § 801.20, or for which FDA has recognized all or part of a performance standard under section 514(c) of the Federal Food, Drug, and Cosmetic Act and has included an exception from the requirement of § 801.20 within the scope of that recognition.

(11) A device packaged within the immediate container of a combination product or convenience kit, *provided that* the label of the combination product or convenience kit bears a UDI.

(b) *National Drug Code (NDC) Numbers.* If a combination product properly bears an NDC number on its label—

(1) The combination product is not subject to the requirements of § 801.20.

(2) A device constituent of such a combination product whose components are physically, chemically, or otherwise combined or mixed and produced as a single entity as described by § 3.2(e)(1) of this chapter is not subject to the requirements of § 801.20.



## Food and Drug Administration, HHS

## § 801.45

(3) Each device constituent of such a combination product, other than one described by §3.2(e)(1) of this chapter, must bear a UDI on its label unless paragraph (a)(11) of this section applies.

(c) *Exception for shipping containers.* This rule does not require a UDI to be placed on any shipping container.

(d) The UDI of a class I device is not required to include a production identifier.

[78 FR 58818, Sept. 24, 2013]

### § 801.35 Voluntary labeling of a device with a unique device identifier.

(a) The labeler of a device that is not required to bear a unique device identifier (UDI) may voluntarily comply with §801.20. If a labeler voluntarily includes a UDI for a device, the labeler may voluntarily provide information concerning the device under subpart E of part 830 of this chapter.

(b) A device may bear both a Universal Product Code (UPC) and a UDI on its label and packages.

[78 FR 58818, Sept. 24, 2013]

### § 801.40 Form of a unique device identifier.

(a) Every unique device identifier (UDI) must meet the technical requirements of §830.20 of this chapter. The UDI must be presented in two forms:

- (1) Easily readable plain-text, and
- (2) Automatic identification and data capture (AIDC) technology.

(b) The UDI must include a device identifier segment. Whenever a device label includes a lot or batch number, a serial number, a manufacturing date, an expiration date, or for a human cell, tissue, or cellular or tissue-based product (HCT/P) regulated as a device, a distinct identification code as required by §1271.290(c) of this chapter, the UDI must include a production identifier segment that conveys such information.

(c) If the AIDC technology is not evident upon visual examination of the label or device package, the label or device package must disclose the presence of AIDC technology.

(d) A class I device that bears a Universal Product Code (UPC) on its label and device packages is deemed to meet

all requirements of subpart B of this part. The UPC will serve as the unique device identifier required by §801.20.

[78 FR 58818, Sept. 24, 2013]

### § 801.45 Devices that must be directly marked with a unique device identifier.

(a) *In general.* A device that must bear a unique device identifier (UDI) on its label must also bear a permanent marking providing the UDI on the device itself if the device is intended to be used more than once and intended to be reprocessed before each use.

(b) *UDI for direct marking.* The UDI provided through a direct marking on a device may be:

(1) Identical to the UDI that appears on the label of the device, or

(2) A different UDI used to distinguish the unpackaged device from any device package containing the device.

(c) *Form of a UDI when provided as a direct marking.* When a device must bear a UDI as a direct marking, the UDI may be provided through either or both of the following:

- (1) Easily readable plain-text;
- (2) Automatic identification and data capture (AIDC) technology, or any alternative technology, that will provide the UDI of the device on demand.

(d) *Exceptions.* The requirement of paragraph (a) of this section shall not apply to any device that meets any of the following criteria:

(1) Any type of direct marking would interfere with the safety or effectiveness of the device;

(2) The device cannot be directly marked because it is not technologically feasible;

(3) The device is a single-use device and is subjected to additional processing and manufacturing for the purpose of an additional single use.

(4) The device has been previously marked under paragraph (a) of this section.

(e) *Exception to be noted in design history file.* A labeler that decides to make use of an exception under paragraph (d) of this section) must document the basis of that decision in the design history file required by §820.30(j) of this chapter.

[78 FR 58818, Sept. 24, 2013]

**§ 801.50 Labeling requirements for stand-alone software.**

(a) Stand-alone software that is not distributed in packaged form (e.g., when downloaded from a Web site) is deemed to meet the UDI labeling requirements of this subpart if it complies with the requirements of paragraph (b) of this section and conveys the version number in its production identifier.

(b) Regardless of whether it is or is not distributed in packaged form, stand-alone software regulated as a medical device must provide its unique device identifier through either or both of the following:

(1) An easily readable plain-text statement displayed whenever the software is started;

(2) An easily readable plain-text statement displayed through a menu command (e.g., an “About \* \* \*” command).

(c) Stand-alone software that is distributed in both packaged form and in a form that is not packaged (e.g., when downloaded from a Web site) may be identified with the same device identifier.

[78 FR 58818, Sept. 24, 2013]

**§ 801.55 Request for an exception from or alternative to a unique device identifier requirement.**

(a) A labeler may submit a request for an exception from or alternative to the requirement of § 801.20 or any other requirement of this subpart for a specified device or a specified type of device. A written request for an exception or alternative must:

(1) Identify the device or devices that would be subject to the exception or alternative;

(2) Identify the provisions of this subpart that are the subject of the request for an exception or alternative;

(3) If requesting an exception, explain why you believe the requirements of this subpart are not technologically feasible;

(4) If requesting an alternative, describe the alternative and explain why it would provide for more accurate, precise, or rapid device identification than the requirements of this subpart or how the alternative would better ensure the safety or effectiveness of the

device that would be subject to the alternative;

(5) Provide, if known, the number of labelers and the number of devices that would be affected if we grant the requested exception or alternative; and

(6) Provide other requested information that the Center Director needs to clarify the scope and effects of the requested exception or alternative.

(b) A written request for an exception or alternative must be submitted by sending it:

(1) If the device is regulated by the Center for Biologics Evaluation and Research (CBER), by email to: *cberudirequests@fda.hhs.gov* or by correspondence to: Food and Drug Administration, Center for Biologics Evaluation and Research, Document Control Center, 10903 New Hampshire Ave., Bldg. 71, Rm. G112, Silver Spring, MD 20993.

(2) In all other cases, by email to: *GUDIDSupport@fda.hhs.gov*, or by correspondence to: UDI Regulatory Policy Support, Center for Devices and Radiological Health, Food and Drug Administration, 10903 New Hampshire Ave., Bldg. 66, Rm. 3303, Silver Spring, MD 20993-0002.

(c) The Center Director may grant an exception or alternative, either in response to a request or on his or her own initiative, if the Center Director determines that an exception is appropriate because the requirements of this subpart are not technologically feasible, or that an alternative would provide for more accurate, precise, or rapid device identification than the requirements of this subpart or would better ensure the safety or effectiveness of the device that would be subject to the alternative. If we grant an exception or alternative, we may include any safeguards or conditions deemed appropriate to ensure the adequate identification of the device through its distribution and use. Any labeler may make use of an exception or alternative granted under this section, provided that such use satisfies all safeguards or conditions that are part of the exception or alternative.

(d) FDA may initiate and grant an exception or alternative if we determine that the exception or alternative is in the best interest of the public

## Food and Drug Administration, HHS

## § 801.60

health. Any such exception or alternative will remain in effect only so long as there remains a public health need for the exception or alternative.

(e) The Center Director may rescind an exception or alternative granted under this section if, after providing an opportunity for an informal hearing as defined in section 201(x) of the Federal Food, Drug, and Cosmetic Act and under part 16 of this chapter, the Center Director determines that the exception or alternative no longer satisfies the criteria described in this paragraph (e) or that any safeguard or condition required under this paragraph (e) has not been met.

[78 FR 58818, Sept. 24, 2013, as amended at 80 FR 18093, Apr. 3, 2015; 81 FR 11428, Mar. 4, 2016]

### § 801.57 Discontinuation of legacy FDA identification numbers assigned to devices.

(a) On the date your device must bear a unique device identifier (UDI) on its label, any National Health-Related Item Code (NHRIC) or National Drug Code (NDC) number assigned to that device is rescinded, and you may no longer provide an NHRIC or NDC number on the label of your device or on any device package.

(b) If your device is not required to bear a UDI on its label, any NHRIC or NDC number assigned to that device is rescinded as of September 24, 2018, and beginning on that date, you may no longer provide an NHRIC or NDC number of the label of your device or on any device package.

(c) A labeler who has been assigned an FDA labeler code to facilitate use of NHRIC or NDC numbers may continue to use that labeler code under a system for the issuance of UDIs, *provided that*—

(1) Such use is consistent with the framework of the issuing agency that operates that system; and

(2) No later than September 24, 2014, the labeler submits, and obtains FDA approval of, a request for continued use of the assigned labeler code. A request for continued use of an assigned labeler code must be submitted by email to: [GUDIDSupport@fda.hhs.gov](mailto:GUDIDSupport@fda.hhs.gov), or by correspondence to: UDI Regulatory Policy Support, Center for Devices and Radiological Health, Food and Drug Admin-

istration, 10903 New Hampshire Ave., Bldg. 66, Rm. 3303, Silver Spring, MD 20993-0002.

(d) Each request for continued use of an assigned labeler code must provide—

(1) The name, mailing address, email address, and phone number of the labeler who is currently using the labeler code;

(2) The owner/operator account identification used by the labeler to submit registration and listing information using FDA's Unified Registration and Listing System (FURLS).

(3) The FDA labeler code that the labeler wants to continue using.

[78 FR 58820, Sept. 24, 2013, as amended at 81 FR 11428, Mar. 4, 2016]

### Subpart C—Labeling Requirements for Over-the-Counter Devices

#### § 801.60 Principal display panel.

The term *principal display panel*, as it applies to over-the-counter devices in package form and as used in this part, means the part of a label that is most likely to be displayed, presented, shown, or examined under customary conditions of display for retail sale. The principal display panel shall be large enough to accommodate all the mandatory label information required to be placed thereon by this part with clarity and conspicuousness and without obscuring designs, vignettes, or crowding. Where packages bear alternate principal display panels, information required to be placed on the principal display panel shall be duplicated on each principal display panel. For the purpose of obtaining uniform type size in declaring the quantity of contents for all packages of substantially the same size, the term *area of the principal display panel* means the area of the side or surface that bears the principal display panel, which area shall be:

(a) In the case of a rectangular package where one entire side properly can be considered to be the principal display panel side, the product of the height times the width of that side;

(b) In the case of a cylindrical or nearly cylindrical container, 40 percent

## § 801.61

## 21 CFR Ch. I (4-1-20 Edition)

of the product of the height of the container times the circumference; and

(c) In the case of any other shape of container, 40 percent of the total surface of the container: *Provided, however*, That where such container presents an obvious “principal display panel” such as the top of a triangular or circular package, the area shall consist of the entire top surface.

In determining the area of the principal display panel, exclude tops, bottoms, flanges at the tops and bottoms of cans, and shoulders and necks of bottles or jars. In the case of cylindrical or nearly cylindrical containers, information required by this part to appear on the principal display panel shall appear within that 40 percent of the circumference which is most likely to be displayed, presented, shown, or examined under customary conditions of display for retail sale.

### § 801.61 Statement of identity.

(a) The principal display panel of an over-the-counter device in package form shall bear as one of its principal features a statement of the identity of the commodity.

(b) Such statement of identity shall be in terms of the common name of the device followed by an accurate statement of the principal intended action(s) of the device. Such statement shall be placed in direct conjunction with the most prominent display of the name and shall employ terms descriptive of the principal intended action(s). The indications for use shall be included in the directions for use of the device, as required by section 502(f)(1) of the act and by the regulations in this part.

(c) The statement of identity shall be presented in bold face type on the principal display panel, shall be in a size reasonably related to the most prominent printed matter on such panel, and shall be in lines generally parallel to the base on which the package rests as it is designed to be displayed.

### § 801.62 Declaration of net quantity of contents.

(a) The label of an over-the-counter device in package form shall bear a declaration of the net quantity of contents. This shall be expressed in the

terms of weight, measure, numerical count, or a combination of numerical count and weight, measure, or size: *Provided, That*:

(1) In the case of a firmly established general consumer usage and trade custom of declaring the quantity of a device in terms of linear measure or measure of area, such respective term may be used. Such term shall be augmented when necessary for accuracy of information by a statement of the weight, measure, or size of the individual units or of the entire device.

(2) If the declaration of contents for a device by numerical count does not give accurate information as to the quantity of the device in the package, it shall be augmented by such statement of weight, measure, or size of the individual units or of the total weight, measure, or size of the device as will give such information; for example, “100 tongue depressors, adult size”, “1 rectal syringe, adult size”, etc. Whenever the Commissioner determines for a specific packaged device that an existing practice of declaring net quantity of contents by weight, measure, numerical count, or a combination of these does not facilitate value comparisons by consumers, he shall by regulation designate the appropriate term or terms to be used for such article.

(b) Statements of weight of the contents shall be expressed in terms of avoirdupois pound and ounce. A statement of liquid measure of the contents shall be expressed in terms of the U.S. gallon of 231 cubic inches and quart, pint, and fluid-ounce subdivisions thereof, and shall express the volume at 68 °F (20 °C). See also paragraph (p) of this section.

(c) The declaration may contain common or decimal fractions. A common fraction shall be in terms of halves, quarters, eighths, sixteenths, or thirty-seconds; except that if there exists a firmly established, general consumer usage and trade custom of employing different common fractions in the net quantity declaration of a particular commodity, they may be employed. A common fraction shall be reduced to its lowest terms; a decimal fraction shall not be carried out to more than two places. A statement that includes

small fractions of an ounce shall be deemed to permit smaller variations than one which does not include such fractions.

(d) The declaration shall be located on the principal display panel of the label, and with respect to packages bearing alternate principal panels it shall be duplicated on each principal display panel.

(e) The declaration shall appear as a distinct item on the principal display panel, shall be separated, by at least a space equal to the height of the lettering used in the declaration, from other printed label information appearing above or below the declaration and, by at least a space equal to twice the width of the letter "N" of the style of type used in the quantity of contents statement, from other printed label information appearing to the left or right of the declaration. It shall not include any term qualifying a unit of weight, measure, or count, such as "giant pint" and "full quart", that tends to exaggerate. It shall be placed on the principal display panel within the bottom 30 percent of the area of the label panel in lines generally parallel to the base on which the package rests as it is designed to be displayed: *Provided, That:*

(1) On packages having a principal display panel of 5 square inches or less the requirement for placement within the bottom 30 percent of the area of the label panel shall not apply when the declaration of net quantity of contents meets the other requirements of this part; and

(2) In the case of a device that is marketed with both outer and inner retail containers bearing the mandatory label information required by this part and the inner container is not intended to be sold separately, the net quantity of contents placement requirement of this section applicable to such inner container is waived.

(3) The principal display panel of a device marketed on a display card to which the immediate container is affixed may be considered to be the display panel of the card, and the type size of the net quantity of contents statement is governed by the dimensions of the display card.

(f) The declaration shall accurately reveal the quantity of device in the

package exclusive of wrappers and other material packed therewith.

(g) The declaration shall appear in conspicuous and easily legible boldface print or type in distinct contrast (by typography, layout, color, embossing, or molding) to other matter on the package; except that a declaration of net quantity blown, embossed, or molded on a glass or plastic surface is permissible when all label information is so formed on the surface. Requirements of conspicuousness and legibility shall include the specifications that:

(1) The ratio of height to width of the letter shall not exceed a differential of 3 units to 1 unit, i.e., no more than 3 times as high as it is wide.

(2) Letter heights pertain to upper case or capital letters. When upper and lower case or all lower case letters are used, it is the lower case letter "o" or its equivalent that shall meet the minimum standards.

(3) When fractions are used, each component numeral shall meet one-half the minimum height standards.

(h) The declaration shall be in letters and numerals in a type size established in relationship to the area of the principal display panel of the package and shall be uniform for all packages of substantially the same size by complying with the following type specifications:

(1) Not less than one-sixteenth inch in height on packages the principal display panel of which has an area of 5 square inches or less.

(2) Not less than one-eighth inch in height on packages the principal display panel of which has an area of more than 5 but not more than 25 square inches.

(3) Not less than three-sixteenths inch in height on packages the principal display panel of which has an area of more than 25 but not more than 100 square inches.

(4) Not less than one-fourth inch in height on packages the principal display panel of which has an area of more than 100 square inches, except not less than one-half inch in height if the area is more than 400 square inches.

Where the declaration is blown, embossed, or molded on a glass or plastic surface rather than by printing, typing, or coloring, the lettering sizes

§ 801.62

21 CFR Ch. I (4–1–20 Edition)

specified in paragraphs (h)(1) through (4) of this section shall be increased by one-sixteenth of an inch.

(i) On packages containing less than 4 pounds or 1 gallon and labeled in terms of weight or fluid measure:

(1) The declaration shall be expressed both in ounces, with identification by weight or by liquid measure and, if applicable (1 pound or 1 pint or more) followed in parentheses by a declaration in pounds for weight units, with any remainder in terms of ounces or common or decimal fractions of the pound (see examples set forth in paragraphs (k) (1) and (2) of this section), or in the case of liquid measure, in the largest whole units (quarts, quarts and pints, or pints, as appropriate) with any remainder in terms of fluid ounces or common or decimal fractions of the pint or quart (see examples set forth in paragraphs (k) (3) and (4) of this section). If the net weight of the package is less than 1 ounce avoirdupois or the net fluid measure is less than 1 fluid ounce, the declaration shall be in terms of common or decimal fractions of the respective ounce and not in terms of drams.

(2) The declaration may appear in more than one line. The term “net weight” shall be used when stating the net quantity of contents in terms of weight. Use of the terms “net” or “net contents” in terms of fluid measure or numerical count is optional. It is sufficient to distinguish avoirdupois ounce from fluid ounce through association of terms; for example, “Net wt. 6 oz” or “6 oz net wt.,” and “6 fl oz” or “net contents 6 fl oz.”

(j) On packages containing 4 pounds or 1 gallon or more and labeled in terms of weight or fluid measure, the declaration shall be expressed in pounds for weight units with any remainder in terms of ounces or common or decimal fractions of the pound; in the case of fluid measure, it shall be expressed in the largest whole unit, i.e., gallons, followed by common or decimal fractions of a gallon or by the next smaller whole unit or units (quarts or quarts and pints), with any remainder in terms of fluid ounces or common or decimal fractions of the pint or quart; see paragraph (k)(5) of this section.

(k) *Examples:* (1) A declaration of 1½ pounds weight shall be expressed as “net wt. 24 oz (1 lb 8 oz),” or “Net wt. 24 oz (1½ lb)” or “Net wt. 24 oz (1.5 lb).”

(2) A declaration of three-fourths pound avoirdupois weight shall be expressed as “Net wt. 12 oz.”

(3) A declaration of 1 quart liquid measure shall be expressed as “Net contents 32 fl oz (1 qt)” or “32 fl oz (1 qt).”

(4) A declaration of 1¾ quarts liquid measure shall be expressed as, “Net contents 56 fl oz (1 qt 1 pt 8 oz)” or “Net contents 56 fl oz (1 qt 1.5 pt),” but not in terms of quart and ounce such as “Net contents 56 fl oz (1 qt 24 oz).”

(5) A declaration of 2½ gallons liquid measure shall be expressed as “Net contents 2 gal 2 qt”, “Net contents 2.5 gallons,” or “Net contents 2½ gal” but not as “2 gal 4 pt”.

(1) For quantities, the following abbreviations and none other may be employed. Periods and plural forms are optional:

gallon gal	liter l
milliliter ml	cubic centimeter cc
quart qt	yard yd
pint pt	feet or foot ft
ounce oz	inch in
pound lb	meter m
grain gr	centimeter cm
kilogram kg	millimeter mm
gram g	fluid fl
milligram mg	square sq
microgram mcg	weight wt

(m) On packages labeled in terms of linear measure, the declaration shall be expressed both in terms of inches and, if applicable (1 foot or more), the largest whole units (yards, yards and feet, feet). The declaration in terms of the largest whole units shall be in parentheses following the declaration in terms of inches and any remainder shall be in terms of inches or common or decimal fractions of the foot or yard; if applicable, as in the case of adhesive tape, the initial declaration in linear inches shall be preceded by a statement of the width. Examples of linear measure are “86 inches (2 yd 1 ft 2 in)”, “90 inches (2½ yd)”, “30 inches (2.5 ft)”, “¾ inch by 36 in (1 yd)”, etc.

(n) On packages labeled in terms of area measure, the declaration shall be expressed both in terms of square inches and, if applicable (1 square foot or more), the largest whole square unit (square yards, square yards and square

feet, square feet). The declaration in terms of the largest whole units shall be in parentheses following the declaration in terms of square inches and any remainder shall be in terms of square inches or common or decimal fractions of the square foot or square yard; for example, “158 sq inches (1 sq ft 14 sq in)”.

(o) Nothing in this section shall prohibit supplemental statements at locations other than the principal display panel(s) describing in nondeceptive terms the net quantity of contents, provided that such supplemental statements of net quantity of contents shall not include any term qualifying a unit of weight, measure, or count that tends to exaggerate the amount of the device contained in the package; for example, “giant pint” and “full quart”. Dual or combination declarations of net quantity of contents as provided for in paragraphs (a) and (i) of this section are not regarded as supplemental net quantity statements and shall be located on the principal display panel.

(p) A separate statement of net quantity of contents in terms of the metric system of weight or measure is not regarded as a supplemental statement and an accurate statement of the net quantity of contents in terms of the metric system of weight or measure may also appear on the principal display panel or on other panels.

(q) The declaration of net quantity of contents shall express an accurate statement of the quantity of contents of the package. Reasonable variations caused by loss or gain of moisture during the course of good distribution practice or by unavoidable deviations in good manufacturing practice will be recognized. Variations from stated quantity of contents shall not be unreasonably large.

**§ 801.63 Medical devices; warning statements for devices containing or manufactured with chlorofluorocarbons and other class I ozone-depleting substances.**

(a) All over-the-counter devices containing or manufactured with chlorofluorocarbons, halons, carbon tetrachloride, methyl chloride, or any other class I substance designated by the Environmental Protection Agency

(EPA) shall carry one of the following warnings:

(1) The EPA warning statement:

WARNING: Contains [or Manufactured with, if applicable] [*insert name of substance*], a substance which harms public health and environment by destroying ozone in the upper atmosphere.

(2) The alternative statement:

NOTE: The indented statement below is required by the Federal government’s Clean Air Act for all products containing or manufactured with chlorofluorocarbons (CFC’s) [or other class I substance, if applicable]:

WARNING: Contains [or Manufactured with, if applicable] [*insert name of substance*], a substance which harms public health and environment by destroying ozone in the upper atmosphere.

CONSULT WITH YOUR PHYSICIAN, HEALTH PROFESSIONAL, OR SUPPLIER IF YOU HAVE ANY QUESTION ABOUT THE USE OF THIS PRODUCT.

(b) The warning statement shall be clearly legible and conspicuous on the product, its immediate container, its outer packaging, or other labeling in accordance with the requirements of 40 CFR part 82 and appear with such prominence and conspicuousness as to render it likely to be read and understood by consumers under normal conditions of purchase. This provision does not replace or relieve a person from any requirements imposed under 40 CFR part 82.

[61 FR 20101, May 3, 1996]

**Subpart D—Exemptions From Adequate Directions for Use**

**§ 801.109 Prescription devices.**

A device which, because of any potentiality for harmful effect, or the method of its use, or the collateral measures necessary to its use is not safe except under the supervision of a practitioner licensed by law to direct the use of such device, and hence for which “adequate directions for use” cannot be prepared, shall be exempt from section 502(f)(1) of the act if all the following conditions are met:

(a) The device is:

(1)(i) In the possession of a person, or his agents or employees, regularly and lawfully engaged in the manufacture,

## § 801.110

transportation, storage, or wholesale or retail distribution of such device; or

(ii) In the possession of a practitioner, such as physicians, dentists, and veterinarians, licensed by law to use or order the use of such device; and

(2) Is to be sold only to or on the prescription or other order of such practitioner for use in the course of his professional practice.

(b) The label of the device, other than surgical instruments, bears:

(1) The symbol statement “Rx only” or “R only” or the statement “Caution: Federal law restricts this device to sale by or on the order of a \_\_\_\_\_”, the blank to be filled with the word “physician”, “dentist”, “veterinarian”, or with the descriptive designation of any other practitioner licensed by the law of the State in which the practitioner practices to use or order the use of the device; and

(2) The method of its application or use.

(c) Labeling on or within the package from which the device is to be dispensed bears information for use, including indications, effects, routes, methods, and frequency and duration of administration, and any relevant hazards, contraindications, side effects, and precautions under which practitioners licensed by law to administer the device can use the device safely and for the purpose for which it is intended, including all purposes for which it is advertised or represented: *Provided, however,* That such information may be omitted from the dispensing package if, but only if, the article is a device for which directions, hazards, warnings, and other information are commonly known to practitioners licensed by law to use the device. Upon written request, stating reasonable grounds therefor, the Commissioner will offer an opinion on a proposal to omit such information from the dispensing package under this proviso.

(d) Any labeling, as defined in section 201(m) of the act, whether or not it is on or within a package from which the device is to be dispensed, distributed by or on behalf of the manufacturer, packer, or distributor of the device, that furnishes or purports to furnish information for use of the device contains

## 21 CFR Ch. I (4–1–20 Edition)

adequate information for such use, including indications, effects, routes, methods, and frequency and duration of administration and any relevant hazards, contraindications, side effects, and precautions, under which practitioners licensed by law to employ the device can use the device safely and for the purposes for which it is intended, including all purposes for which it is advertised or represented. This information will not be required on so-called reminder—piece labeling which calls attention to the name of the device but does not include indications or other use information.

(e) All labeling, except labels and cartons, bearing information for use of the device also bears the date of the issuance or the date of the latest revision of such labeling.

[41 FR 6896, Feb. 13, 1976, as amended at 81 FR 38930, June 15, 2016]

### § 801.110 Retail exemption for prescription devices.

A device subject to § 801.109 shall be exempt at the time of delivery to the ultimate purchaser or user from section 502(f)(1) of the act if it is delivered by a licensed practitioner in the course of his professional practice or upon a prescription or other order lawfully issued in the course of his professional practice, with labeling bearing the name and address of such licensed practitioner and the directions for use and cautionary statements, if any, contained in such order.

### § 801.116 Medical devices having commonly known directions.

A device shall be exempt from section 502(f)(1) of the act insofar as adequate directions for common uses thereof are known to the ordinary individual.

### § 801.119 In vitro diagnostic products.

A product intended for use in the diagnosis of disease and which is an in vitro diagnostic product as defined in § 809.3(a) of this chapter shall be deemed to be in compliance with the requirements of this part and section 502(f)(1) of the Federal Food, Drug, and



## Food and Drug Administration, HHS

## § 801.128

Cosmetic Act if it meets the requirements of subpart B of this part and the requirements of § 809.10 of this chapter.

[78 FR 58820, Sept. 24, 2013]

### **§ 801.122 Medical devices for processing, repacking, or manufacturing.**

A device intended for processing, repacking, or use in the manufacture of another drug or device shall be exempt from section 502(f)(1) of the act if its label bears the statement “Caution: For manufacturing, processing, or repacking”.

### **§ 801.125 Medical devices for use in teaching, law enforcement, research, and analysis.**

A device subject to § 801.109 shall be exempt from section 502(f)(1) of this act if shipped or sold to, or in the possession of, persons regularly and lawfully engaged in instruction in pharmacy, chemistry, or medicine not involving clinical use, or engaged in law enforcement, or in research not involving clinical use, or in chemical analysis, or physical testing, and is to be used only for such instruction, law enforcement, research, analysis, or testing.

### **§ 801.127 Medical devices; expiration of exemptions.**

(a) If a shipment or delivery, or any part thereof, of a device which is exempt under the regulations in this section is made to a person in whose possession the article is not exempt, or is made for any purpose other than those specified, such exemption shall expire, with respect to such shipment or delivery or part thereof, at the beginning of that shipment or delivery. The causing of an exemption to expire shall be considered an act which results in such device being misbranded unless it is disposed of under circumstances in which it ceases to be a drug or device.

(b) The exemptions conferred by §§ 801.119, 801.122, and 801.125 shall continue until the devices are used for the purposes for which they are exempted, or until they are relabeled to comply with section 502(f)(1) of the act. If, however, the device is converted, or manufactured into a form limited to prescription dispensing, no exemption shall thereafter apply to the article un-

less the device is labeled as required by § 801.109.

### **§ 801.128 Exceptions or alternatives to labeling requirements for medical devices held by the Strategic National Stockpile.**

(a) The appropriate FDA Center Director may grant an exception or alternative to any provision listed in paragraph (f) of this section and not explicitly required by statute, for specified lots, batches, or other units of a medical device, if the Center Director determines that compliance with such labeling requirement could adversely affect the safety, effectiveness, or availability of such devices that are or will be included in the Strategic National Stockpile.

(b)(1)(i) A Strategic National Stockpile official or any entity that manufactures (including labeling, packing, relabeling, or repackaging), distributes, or stores devices that are or will be included in the Strategic National Stockpile may submit, with written concurrence from a Strategic National Stockpile official, a written request for an exception or alternative described in paragraph (a) of this section to the Center Director.

(ii) The Center Director may grant an exception or alternative described in paragraph (a) of this section on his or her own initiative.

(2) A written request for an exception or alternative described in paragraph (a) of this section must:

(i) Identify the specified lots, batches, or other units of the medical device that would be subject to the exception or alternative;

(ii) Identify the labeling provision(s) listed in paragraph (f) of this section that are the subject of the exception or alternative request;

(iii) Explain why compliance with the labeling provision(s) could adversely affect the safety, effectiveness, or availability of the specified lots, batches, or other units of a medical device that are or will be held in the Strategic National Stockpile;

(iv) Describe any proposed safeguards or conditions that will be implemented so that the labeling of the device includes appropriate information necessary for the safe and effective use of

## § 801.150

the device, given the anticipated circumstances of use of the device;

(v) Provide a draft of the proposed labeling of the specified lots, batches, or other units of the medical device subject to the exception or alternative; and

(vi) Provide any other information requested by the Center Director in support of the request.

(c) The Center Director must respond in writing to all requests under this section. The Center Director may impose appropriate conditions when granting such an exception or alternative under this section.

(d) A grant of an exception or alternative under this section will include any safeguards or conditions deemed appropriate by the Center Director so that the labeling of devices subject to the exception or alternative includes the information necessary for the safe and effective use of the device, given the anticipated circumstances of use.

(e) If the Center Director grants a request for an exception or alternative to the labeling requirements under this section:

(1) The Center Director may determine that the submission and grant of a written request under this section satisfies the provisions relating to premarket notification submissions under § 807.81(a)(3) of this chapter.

(2)(i) For a Premarket Approval Application (PMA)-approved device, the submission and grant of a written request under this section satisfies the provisions relating to submission of PMA supplements under § 814.39 of this chapter; however,

(ii) The grant of the request must be identified in a periodic report under § 814.84 of this chapter.

(f) The Center Director may grant an exception or alternative under this section to the following provisions of this chapter, to the extent that the requirements in these provisions are not explicitly required by statute:

(1) § 801.1(d);

(2) Subpart B of this part and part 830 of this chapter in its entirety;

(3) § 801.60;

(4) § 801.61;

(5) § 801.62;

(6) § 801.63;

(7) § 801.109; and

## 21 CFR Ch. I (4–1–20 Edition)

(8) Part 801, subpart H.

[72 FR 73601, Dec. 28, 2007, as amended at 78 FR 58820, Sept. 24, 2013]

### Subpart E—Other Exemptions

#### § 801.150 Medical devices; processing, labeling, or repacking.

(a) Except as provided by paragraphs (b) and (c) of this section, a shipment or other delivery of a device which is, in accordance with the practice of the trade, to be processed, labeled, or repacked, in substantial quantity at an establishment other than that where originally processed or packed, shall be exempt, during the time of introduction into and movement in interstate commerce and the time of holding in such establishment, from compliance with the labeling and packaging requirements of section 502(b) and (f) of the act if:

(1) The person who introduced such shipment or delivery into interstate commerce is the operator of the establishment where such device is to be processed, labeled, or repacked; or

(2) In case such person is not such operator, such shipment or delivery is made to such establishment under a written agreement, signed by and containing the post office addresses of such person and such operator, and containing such specifications for the processing, labeling, or repacking, as the case may be, of such device in such establishment as will insure, if such specifications are followed, that such device will not be adulterated or misbranded within the meaning of the act upon completion of such processing, labeling, or repacking. Such person and such operator shall each keep a copy of such agreement until 2 years after the final shipment or delivery of such device from such establishment, and shall make such copies available for inspection at any reasonable hour to any officer or employee of the Department who requests them.

(b) An exemption of a shipment or other delivery of a device under paragraph (a)(1) of this section shall, at the beginning of the act of removing such shipment or delivery, or any part thereof, from such establishment, become void ab initio if the device comprising such shipment, delivery, or part

is adulterated or misbranded within the meaning of the act when so removed.

(c) An exemption of a shipment or other delivery of a device under paragraph (a)(2) of this section shall become void ab initio with respect to the person who introduced such shipment or delivery into interstate commerce upon refusal by such person to make available for inspection a copy of the agreement, as required by such paragraph (a)(2).

(d) An exemption of a shipment or other delivery of a device under paragraph (a)(2) of this section shall expire:

(1) At the beginning of the act of removing such shipment or delivery, or any part thereof, from such establishment if the device comprising such shipment, delivery, or part is adulterated or misbranded within the meaning of the act when so removed; or

(2) Upon refusal by the operator of the establishment where such device is to be processed, labeled, or repacked, to make available for inspection a copy of the agreement, as required by such clause.

(e) As it is a common industry practice to manufacture and/or assemble, package, and fully label a device as sterile at one establishment and then ship such device in interstate commerce to another establishment or to a contract sterilizer for sterilization, the Food and Drug Administration will initiate no regulatory action against the device as misbranded or adulterated when the nonsterile device is labeled sterile, provided all the following conditions are met:

(1) There is in effect a written agreement which:

(i) Contains the names and post office addresses of the firms involved and is signed by the person authorizing such shipment and the operator or person in charge of the establishment receiving the devices for sterilization.

(ii) Provides instructions for maintaining proper records or otherwise accounting for the number of units in each shipment to insure that the number of units shipped is the same as the number received and sterilized.

(iii) Acknowledges that the device is nonsterile and is being shipped for further processing, and

(iv) States in detail the sterilization process, the gaseous mixture or other media, the equipment, and the testing method or quality controls to be used by the contract sterilizer to assure that the device will be brought into full compliance with the Federal Food, Drug, and Cosmetic Act.

(2) Each pallet, carton, or other designated unit is conspicuously marked to show its nonsterile nature when it is introduced into and is moving in interstate commerce, and while it is being held prior to sterilization. Following sterilization, and until such time as it is established that the device is sterile and can be released from quarantine, each pallet, carton, or other designated unit is conspicuously marked to show that it has not been released from quarantine, e.g., "sterilized—awaiting test results" or an equivalent designation.

### Subparts F–G [Reserved]

### Subpart H—Special Requirements for Specific Devices

#### § 801.405 Labeling of articles intended for lay use in the repairing and/or refitting of dentures.

(a) The American Dental Association and leading dental authorities have advised the Food and Drug Administration of their concern regarding the safety of denture reliners, repair kits, pads, cushions, and other articles marketed and labeled for lay use in the repairing, refitting, or cushioning of ill-fitting, broken, or irritating dentures. It is the opinion of dental authorities and the Food and Drug Administration that to properly repair and properly refit dentures a person must have professional knowledge and specialized technical skill. Laymen cannot be expected to maintain the original vertical dimension of occlusion and the centric relation essential in the proper repairing or refitting of dentures. The continued wearing of improperly repaired or refitted dentures may cause acceleration of bone resorption, soft tissue hyperplasia, and other irreparable damage to the oral cavity. Such articles designed for lay use should be

**§ 801.410**

**21 CFR Ch. I (4–1–20 Edition)**

limited to emergency or temporary situations pending the services of a licensed dentist.

(b) The Food and Drug Administration therefore regards such articles as unsafe and misbranded under the Federal Food, Drug, and Cosmetic Act, unless the labeling:

(1)(i) Limits directions for use for denture repair kits to emergency repairing pending unavoidable delay in obtaining professional reconstruction of the denture;

(ii) Limits directions for use for denture liners, pads, and cushions to temporary refitting pending unavoidable delay in obtaining professional reconstruction of the denture;

(2) Contains in a conspicuous manner the word “emergency” preceding and modifying each indication-for-use statement for denture repair kits and the word “temporary” preceding and modifying each indication-for-use statement for liners, pads, and cushions; and

(3) Includes a conspicuous warning statement to the effect:

(i) For denture repair kits: “*Warning—For emergency repairs only.* Long term use of home-repaired dentures may cause faster bone loss, continuing irritation, sores, and tumors. This kit for emergency use only. See Dentist Without Delay.”

(ii) For denture liners, pads, and cushions: “*Warning—For temporary use only.* Longterm use of this product may lead to faster bone loss, continuing irritation, sores, and tumors. For Use Only Until a Dentist Can Be Seen.”

(c) Adequate directions for use require full information of the temporary and emergency use recommended in order for the layman to understand the limitations of usefulness, the reasons therefor, and the importance of adhering to the warnings. Accordingly, the labeling should contain substantially the following information:

(1) For denture repair kits: Special training and tools are needed to repair dentures to fit properly. Home-repaired dentures may cause irritation to the gums and discomfort and tiredness while eating. Long term use may lead to more troubles, even permanent changes in bones, teeth, and gums, which may make it impossible to wear

dentures in the future. For these reasons, dentures repaired with this kit should be used only in an emergency until a dentist can be seen. Dentures that don't fit properly cause irritation and injury to the gums and faster bone loss, which is permanent. Dentures that don't fit properly cause gum changes that may require surgery for correction. Continuing irritation and injury may lead to cancer in the mouth. You must see your dentist as soon as possible.

(2) For denture liners, pads, and cushions: Use of these preparations or devices may temporarily decrease the discomfort; however, their use will not make the denture fit properly. Special training and tools are needed to repair a denture to fit properly. Dentures that do not fit properly cause irritation and injury to the gums and faster bone loss, which is permanent and may require a completely new denture. Changes in the gums caused by dentures that do not fit properly may require surgery for correction. Continuing irritation and injury may lead to cancer in the mouth. You must see your dentist as soon as possible.

(3) If the denture relining or repairing material forms a permanent bond with the denture, a warning statement to the following effect should be included: “This reliner becomes fixed to the denture and a completely new denture may be required because of its use.”

(d) Labeling claims exaggerating the usefulness or the safety of the material or failing to disclose all facts relevant to the claims of usefulness will be regarded as false and misleading under sections 201(n) and 502(a) of the Federal Food, Drug, and Cosmetic Act.

(e) Regulatory action may be initiated with respect to any article found within the jurisdiction of the act contrary to the provisions of this policy statement after 90 days following the date of publication of this section in the FEDERAL REGISTER.

**§ 801.410 Use of impact-resistant lenses in eyeglasses and sunglasses.**

(a) Examination of data available on the frequency of eye injuries resulting from the shattering of ordinary crown glass lenses indicates that the use of

such lenses constitutes an avoidable hazard to the eye of the wearer.

(b) The consensus of the ophthalmic community is that the number of eye injuries would be substantially reduced by the use in eyeglasses and sunglasses of impact-resistant lenses.

(c)(1) To protect the public more adequately from potential eye injury, eyeglasses and sunglasses must be fitted with impact-resistant lenses, except in those cases where the physician or optometrist finds that such lenses will not fulfill the visual requirements of the particular patient, directs in writing the use of other lenses, and gives written notification thereof to the patient.

(2) The physician or optometrist shall have the option of ordering glass lenses, plastic lenses, or laminated glass lenses made impact resistant by any method; however, all such lenses shall be capable of withstanding the impact test described in paragraph (d)(2) of this section.

(3) Each finished impact-resistant glass lens for prescription use shall be individually tested for impact resistance and shall be capable of withstanding the impact test described in paragraph (d)(2) of this section. Raised multifocal lenses shall be impact resistant but need not be tested beyond initial design testing. Prism segment multifocal, slab-off prism, lenticular cataract, iseikonic, depressed segment one-piece multifocal, bioconcave, myodisc and minus lenticular, custom laminate and cemented assembly lenses shall be impact resistant but need not be subjected to impact testing. To demonstrate that all other types of impact-resistant lenses, including impact-resistant laminated glass lenses (i.e., lenses other than those described in the three preceding sentences of this paragraph (c)(3)), are capable of withstanding the impact test described in this regulation, the manufacturer of these lenses shall subject to an impact test a statistically significant sampling of lenses from each production batch, and the lenses so tested shall be representative of the finished forms as worn by the wearer, including finished forms that are of minimal lens thickness and have been subjected to any treatment used to im-

part impact resistance. All non-prescription lenses and plastic prescription lenses tested on the basis of statistical significance shall be tested in uncut-finished or finished form.

(d)(1) For the purpose of this regulation, the impact test described in paragraph (d)(2) of this section shall be the "referee test," defined as "one which will be utilized to determine compliance with a regulation." The referee test provides the Food and Drug Administration with the means of examining a medical device for performance and does not inhibit the manufacturer from using equal or superior test methods. A lens manufacturer shall conduct tests of lenses using the impact test described in paragraph (d)(2) of this section or any equal or superior test. Whatever test is used, the lenses shall be capable of withstanding the impact test described in paragraph (d)(2) of this section if the Food and Drug Administration examines them for performance.

(2) In the impact test, a 5/8-inch steel ball weighing approximately 0.56 ounce is dropped from a height of 50 inches upon the horizontal upper surface of the lens. The ball shall strike within a 5/8-inch diameter circle located at the geometric center of the lens. The ball may be guided but not restricted in its fall by being dropped through a tube extending to within approximately 4 inches of the lens. To pass the test, the lens must not fracture; for the purpose of this section, a lens will be considered to have fractured if it cracks through its entire thickness, including a laminar layer, if any, and across a complete diameter into two or more separate pieces, or if any lens material visible to the naked eyes becomes detached from the ocular surface. The test shall be conducted with the lens supported by a tube (1-inch inside diameter, 1 1/4-inch outside diameter, and approximately 1-inch high) affixed to a rigid iron or steel base plate. The total weight of the base plate and its rigidly attached fixtures shall be not less than 27 pounds. For lenses of small minimum diameter, a support tube having an outside diameter of less than 1 1/4 inches may be used. The support tube shall be made of rigid acrylic plastic, steel, or other suitable substance and

shall have securely bonded on the top edge a 1/8- by 1/8-inch neoprene gasket having a hardness of 40 ±5, as determined by ASTM Method D 1415-88, “Standard Test Method for Rubber Property—International Hardness” a minimum tensile strength of 1,200 pounds, as determined by ASTM Method D 412-98A, “Standard Test Methods for Vulcanized Rubber and Thermoplastic Elastomers—Tension,” and a minimum ultimate elongation of 400 percent, as determined by ASTM Method D 412-68 (Both methods are incorporated by reference and are available from the American Society for Testing Materials, 100 Barr Harbor Dr., West Conshohocken, Philadelphia, PA 19428, or available for inspection at the Center for Devices and Radiological Health’s Library, 9200 Corporate Blvd., Rockville, MD 20850, or at the National Archives and Records Administration (NARA). For information on the availability of this material at NARA, call 202-741-6030, or go to: [http://www.archives.gov/federal\\_register/code\\_of\\_federal\\_regulations/ibr\\_locations.html](http://www.archives.gov/federal_register/code_of_federal_regulations/ibr_locations.html). The diameter or contour of the lens support may be modified as necessary so that the 1/8- by 1/8-inch neoprene gasket supports the lens at its periphery.

(e) Copies of invoice(s), shipping document(s), and records of sale or distribution of all impact resistant lenses, including finished eyeglasses and sunglasses, shall be kept and maintained for a period of 3 years; however, the names and addresses of individuals purchasing nonprescription eyeglasses and sunglasses at the retail level need not be kept and maintained by the retailer. The records kept in compliance with this paragraph shall be made available upon request at all reasonable hours by any officer or employee of the Food and Drug Administration or by any other officer or employee acting on behalf of the Secretary of Health and Human Services and such officer or employee shall be permitted to inspect and copy such records, to make such inventories of stock as he deems necessary, and otherwise to check the correctness of such inventories.

(f) In addition, those persons conducting tests in accordance with paragraph (d) of this section shall maintain

the results thereof and a description of the test method and of the test apparatus for a period of 3 years. These records shall be made available upon request at any reasonable hour by any officer or employee acting on behalf of the Secretary of Health and Human Services. The persons conducting tests shall permit the officer or employee to inspect and copy the records, to make such inventories of stock as the officer or employee deems necessary, and otherwise to check the correctness of the inventories.

(g) For the purpose of this section, the term “manufacturer” includes an importer for resale. Such importer may have the tests required by paragraph (d) of this section conducted in the country of origin but must make the results thereof available, upon request, to the Food and Drug Administration, as soon as practicable.

(h) All lenses must be impact-resistant except when the physician or optometrist finds that impact-resistant lenses will not fulfill the visual requirements for a particular patient.

(i) This statement of policy does not apply to contact lenses.

[41 FR 6896, Feb. 13, 1976, as amended at 44 FR 20678, Apr. 6, 1979; 47 FR 9397, Mar. 5, 1982; 65 FR 3586, Jan. 24, 2000; 65 FR 44436, July 18, 2000; 69 FR 18803, Apr. 9, 2004]

#### § 801.415 Maximum acceptable level of ozone.

(a) Ozone is a toxic gas with no known useful medical application in specific, adjunctive, or preventive therapy. In order for ozone to be effective as a germicide, it must be present in a concentration far greater than that which can be safely tolerated by man and animals.

(b) Although undesirable physiological effects on the central nervous system, heart, and vision have been reported, the predominant physiological effect of ozone is primary irritation of the mucous membranes. Inhalation of ozone can cause sufficient irritation to the lungs to result in pulmonary edema. The onset of pulmonary edema is usually delayed for some hours after exposure; thus, symptomatic response is not a reliable warning of exposure to toxic concentrations of ozone. Since olfactory fatigue develops readily, the

odor of ozone is not a reliable index of atmospheric ozone concentration.

(c) A number of devices currently on the market generate ozone by design or as a byproduct. Since exposure to ozone above a certain concentration can be injurious to health, any such device will be considered adulterated and/or misbranded within the meaning of sections 501 and 502 of the act if it is used or intended for use under the following conditions:

(1) In such a manner that it generates ozone at a level in excess of 0.05 part per million by volume of air circulating through the device or causes an accumulation of ozone in excess of 0.05 part per million by volume of air (when measured under standard conditions at 25 °C (77 °F) and 760 millimeters of mercury) in the atmosphere of enclosed space intended to be occupied by people for extended periods of time, e.g., houses, apartments, hospitals, and offices. This applies to any such device, whether portable or permanent or part of any system, which generates ozone by design or as an inadvertent or incidental product.

(2) To generate ozone and release it into the atmosphere in hospitals or other establishments occupied by the ill or infirm.

(3) To generate ozone and release it into the atmosphere and does not indicate in its labeling the maximum acceptable concentration of ozone which may be generated (not to exceed 0.05 part per million by volume of air circulating through the device) as established herein and the smallest area in which such device can be used so as not to produce an ozone accumulation in excess of 0.05 part per million.

(4) In any medical condition for which there is no proof of safety and effectiveness.

(5) To generate ozone at a level less than 0.05 part per million by volume of air circulating through the device and it is labeled for use as a germicide or deodorizer.

(d) This section does not affect the present threshold limit value of 0.10 part per million (0.2 milligram per cubic meter) of ozone exposure for an 8-hour-day exposure of industrial workers as recommended by the American

Conference of Governmental Industrial Hygienists.

(e) The method and apparatus specified in 40 CFR part 50, or any other equally sensitive and accurate method, may be employed in measuring ozone pursuant to this section.

**§ 801.417 Chlorofluorocarbon propellants.**

The use of chlorofluorocarbon in devices as propellants in self-pressurized containers is generally prohibited except as provided in § 2.125 of this chapter.

[43 FR 11318, Mar. 17, 1978]

**§ 801.420 Hearing aid devices; professional and patient labeling.**

(a) *Definitions for the purposes of this section and § 801.421.* (1) *Hearing aid* means any wearable instrument or device designed for, offered for the purpose of, or represented as aiding persons with or compensating for, impaired hearing.

(2) *Ear specialist* means any licensed physician who specializes in diseases of the ear and is medically trained to identify the symptoms of deafness in the context of the total health of the patient, and is qualified by special training to diagnose and treat hearing loss. Such physicians are also known as otolaryngologists, otologists, and otorhinolaryngologists.

(3) *Dispenser* means any person, partnership, corporation, or association engaged in the sale, lease, or rental of hearing aids to any member of the consuming public or any employee, agent, sales person, and/or representative of such a person, partnership, corporation, or association.

(4) *Audiologist* means any person qualified by training and experience to specialize in the evaluation and rehabilitation of individuals whose communication disorders center in whole or in part in the hearing function. In some states audiologists must satisfy specific requirements for licensure.

(5) *Sale or purchase* includes any lease or rental of a hearing aid to a member of the consuming public who is a user or prospective user of a hearing aid.

(6) *Used hearing aid* means any hearing aid that has been worn for any period of time by a user. However, a hearing aid shall not be considered “used” merely because it has been worn by a prospective user as a part of a bona fide hearing aid evaluation conducted to determine whether to select that particular hearing aid for that prospective user, if such evaluation has been conducted in the presence of the dispenser or a hearing aid health professional selected by the dispenser to assist the buyer in making such a determination.

(b) *Label requirements for hearing aids.* Hearing aids shall be clearly and permanently marked with:

(1) The name of the manufacturer or distributor, the model name or number, the serial number, and the year of manufacture.

(2) A “ + ” symbol to indicate the positive connection for battery insertion, unless it is physically impossible to insert the battery in the reversed position.

(c) *Labeling requirements for hearing aids*—(1) *General.* All labeling information required by this paragraph shall be included in a User Instructional Brochure that shall be developed by the manufacturer or distributor, shall accompany the hearing aid, and shall be provided to the prospective user by the dispenser of the hearing aid in accordance with § 801.421(c). The User Instructional Brochure accompanying each hearing aid shall contain the following information and instructions for use, to the extent applicable to the particular requirements and characteristics of the hearing aid:

(i) An illustration(s) of the hearing aid, indicating operating controls, user adjustments, and battery compartment.

(ii) Information on the function of all controls intended for user adjustment.

(iii) A description of any accessory that may accompany the hearing aid, e.g., accessories for use with a television or telephone.

(iv) Specific instructions for:

(a) Use of the hearing aid.

(b) Maintenance and care of the hearing aid, including the procedure to follow in washing the earmold, when replacing tubing on those hearing aids that use tubing, and in storing the

hearing aid when it will not be used for an extended period of time.

(c) Replacing or recharging the batteries, including a generic designation of replacement batteries.

(v) Information on how and where to obtain repair service, including at least one specific address where the user can go, or send the hearing aid to, to obtain such repair service.

(vi) A description of commonly occurring avoidable conditions that could adversely affect or damage the hearing aid, such as dropping, immersing, or exposing the hearing aid to excessive heat.

(vii) Identification of any known side effects associated with the use of a hearing aid that may warrant consultation with a physician, e.g., skin irritation and accelerated accumulation of cerumen (ear wax).

(viii) A statement that a hearing aid will not restore normal hearing and will not prevent or improve a hearing impairment resulting from organic conditions.

(ix) A statement that in most cases infrequent use of a hearing aid does not permit a user to attain full benefit from it.

(x) A statement that the use of a hearing aid is only part of hearing habilitation and may need to be supplemented by auditory training and instruction in lipreading.

(xi) The warning statement required by paragraph (c)(2) of this section.

(xii) The notice for prospective hearing aid users required by paragraph (c)(3) of this section.

(xiii) The technical data required by paragraph (c)(4) of this section, unless such data is provided in separate labeling accompanying the device.

(2) *Warning statement.* The User Instructional Brochure shall contain the following warning statement:

WARNING TO HEARING AID DISPENSERS

A hearing aid dispenser should advise a prospective hearing aid user to consult promptly with a licensed physician (preferably an ear specialist) before dispensing a hearing aid if the hearing aid dispenser determines through inquiry, actual observation, or review of any other available information concerning the prospective user, that the prospective user has any of the following conditions:



- (i) Visible congenital or traumatic deformity of the ear.
- (ii) History of active drainage from the ear within the previous 90 days.
- (iii) History of sudden or rapidly progressive hearing loss within the previous 90 days.
- (iv) Acute or chronic dizziness.
- (v) Unilateral hearing loss of sudden or recent onset within the previous 90 days.
- (vi) Audiometric air-bone gap equal to or greater than 15 decibels at 500 hertz (Hz), 1,000 Hz, and 2,000 Hz.
- (vii) Visible evidence of significant cerumen accumulation or a foreign body in the ear canal.
- (viii) Pain or discomfort in the ear.

Special care should be exercised in selecting and fitting a hearing aid whose maximum sound pressure level exceeds 132 decibels because there may be risk of impairing the remaining hearing of the hearing aid user. (This provision is required only for those hearing aids with a maximum sound pressure capability greater than 132 decibels (dB).)

(3) *Notice for prospective hearing aid users.* The User Instructional Brochure shall contain the following notice:

IMPORTANT NOTICE FOR PROSPECTIVE HEARING  
AID USERS

Good health practice requires that a person with a hearing loss have a medical evaluation by a licensed physician (preferably a physician who specializes in diseases of the ear) before purchasing a hearing aid. Licensed physicians who specialize in diseases of the ear are often referred to as otolaryngologists, otologists or otorhinolaryngologists. The purpose of medical evaluation is to assure that all medically treatable conditions that may affect hearing are identified and treated before the hearing aid is purchased.

Following the medical evaluation, the physician will give you a written statement that states that your hearing loss has been medically evaluated and that you may be considered a candidate for a hearing aid. The physician will refer you to an audiologist or a hearing aid dispenser, as appropriate, for a hearing aid evaluation.

The audiologist or hearing aid dispenser will conduct a hearing aid evaluation to assess your ability to hear with and without a hearing aid. The hearing aid evaluation will enable the audiologist or dispenser to select and fit a hearing aid to your individual needs.

If you have reservations about your ability to adapt to amplification, you should inquire about the availability of a trial-rental or purchase-option program. Many hearing aid dispensers now offer programs that permit you to wear a hearing aid for a period of time for a nominal fee after which you may

decide if you want to purchase the hearing aid.

Federal law restricts the sale of hearing aids to those individuals who have obtained a medical evaluation from a licensed physician. Federal law permits a fully informed adult to sign a waiver statement declining the medical evaluation for religious or personal beliefs that preclude consultation with a physician. The exercise of such a waiver is not in your best health interest and its use is strongly discouraged.

CHILDREN WITH HEARING LOSS

In addition to seeing a physician for a medical evaluation, a child with a hearing loss should be directed to an audiologist for evaluation and rehabilitation since hearing loss may cause problems in language development and the educational and social growth of a child. An audiologist is qualified by training and experience to assist in the evaluation and rehabilitation of a child with a hearing loss.

(4) *Technical data.* Technical data useful in selecting, fitting, and checking the performance of a hearing aid shall be provided in the User Instructional Brochure or in separate labeling that accompanies the device. The determination of technical data values for the hearing aid labeling shall be conducted in accordance with the test procedures of the American National Standard "Specification of Hearing Aid Characteristics," ANSI S3.22-2003 (Revision of ANSI S3.22-1996) (Includes April 2007 Erratum). The Director of the Office of the Federal Register approves this incorporation by reference in accordance with 5 U.S.C. 552(a) and 1 CFR part 51. Copies are available from the Standards Secretariat of the Acoustical Society of America, 120 Wall St., New York, NY 10005-3993, or are available for inspection at the Regulations Staff, CDRH (HFZ-215), FDA, 1350 Piccard Dr., rm. 150, Rockville, MD 20850, or at the National Archives and Records Administration (NARA). For information on the availability of this material at NARA, call 202-741-6030, or go to: [http://www.archives.gov/federal-register/code\\_of\\_federal\\_regulations/ibr\\_locations.html](http://www.archives.gov/federal-register/code_of_federal_regulations/ibr_locations.html). As a minimum, the User Instructional Brochure or such other labeling shall include the appropriate values or information for the following technical data elements as

**§ 801.421**

**21 CFR Ch. I (4–1–20 Edition)**

these elements are defined or used in such standard:

- (i) Saturation output curve (SSPL 90 curve).
- (ii) Frequency response curve.
- (iii) Average saturation output (HF-Average SSPL 90).
- (iv) Average full-on gain (HF-Average full-on gain).
- (v) Reference test gain.
- (vi) Frequency range.
- (vii) Total harmonic distortion.
- (viii) Equivalent input noise.
- (ix) Battery current drain.
- (x) Induction coil sensitivity (telephone coil aids only).
- (xi) Input-output curve (ACG aids only).
- (xii) Attack and release times (ACG aids only).

(5) *Statement if hearing aid is used or rebuilt.* If a hearing aid has been used or rebuilt, this fact shall be declared on the container in which the hearing aid is packaged and on a tag that is physically attached to such hearing aid. Such fact may also be stated in the User Instructional Brochure.

(6) *Statements in User Instructional Brochure other than those required.* A User Instructional Brochure may contain statements or illustrations in addition to those required by paragraph (c) of this section if the additional statements:

- (i) Are not false or misleading in any particular, e.g., diminishing the impact of the required statements; and
- (ii) Are not prohibited by this chapter or by regulations of the Federal Trade Commission.

[42 FR 9294, Feb. 15, 1977, as amended at 47 FR 9398, Mar. 5, 1982; 50 FR 30154, July 24, 1985; 54 FR 52396, Dec. 21, 1989; 64 FR 59620, Nov. 3, 1999; 69 FR 18803, Apr. 9, 2004; 73 FR 31360, June 2, 2008]

**§ 801.421 Hearing aid devices; conditions for sale.**

(a) *Medical evaluation requirements—*  
(1) *General.* Except as provided in paragraph (a)(2) of this section, a hearing aid dispenser shall not sell a hearing aid unless the prospective user has presented to the hearing aid dispenser a written statement signed by a licensed physician that states that the patient's hearing loss has been medically evaluated and the patient may be considered

a candidate for a hearing aid. The medical evaluation must have taken place within the preceding 6 months.

(2) *Waiver to the medical evaluation requirements.* If the prospective hearing aid user is 18 years of age or older, the hearing aid dispenser may afford the prospective user an opportunity to waive the medical evaluation requirement of paragraph (a)(1) of this section provided that the hearing aid dispenser:

- (i) Informs the prospective user that the exercise of the waiver is not in the user's best health interest;
- (ii) Does not in any way actively encourage the prospective user to waive such a medical evaluation; and
- (iii) Affords the prospective user the opportunity to sign the following statement:

I have been advised by \_\_\_\_\_ (Hearing aid dispenser's name) that the Food and Drug Administration has determined that my best health interest would be served if I had a medical evaluation by a licensed physician (preferably a physician who specializes in diseases of the ear) before purchasing a hearing aid. I do not wish a medical evaluation before purchasing a hearing aid.

(b) *Opportunity to review User Instructional Brochure.* Before signing any statement under paragraph (a)(2)(iii) of this section and before the sale of a hearing aid to a prospective user, the hearing aid dispenser shall:

- (1) Provide the prospective user a copy of the User Instructional Brochure for a hearing aid that has been, or may be selected for the prospective user;
- (2) Review the content of the User Instructional Brochure with the prospective user orally, or in the predominate method of communication used during the sale;
- (3) Afford the prospective user an opportunity to read the User Instructional Brochure.

(c) *Availability of User Instructional Brochure.* (1) Upon request by an individual who is considering purchase of a hearing aid, a dispenser shall, with respect to any hearing aid that he dispenses, provide a copy of the User Instructional Brochure for the hearing aid or the name and address of the manufacturer or distributor from

whom a User Instructional Brochure for the hearing aid may be obtained.

(2) In addition to assuring that a User Instructional Brochure accompanies each hearing aid, a manufacturer or distributor shall with respect to any hearing aid that he manufactures or distributes:

(i) Provide sufficient copies of the User Instructional Brochure to sellers for distribution to users and prospective users;

(ii) Provide a copy of the User Instructional Brochure to any hearing aid professional, user, or prospective user who requests a copy in writing.

(d) *Recordkeeping.* The dispenser shall retain for 3 years after the dispensing of a hearing aid a copy of any written statement from a physician required under paragraph (a)(1) of this section or any written statement waiving medical evaluation required under paragraph (a)(2)(iii) of this section.

(e) *Exemption for group auditory trainers.* Group auditory trainers, defined as a group amplification system purchased by a qualified school or institution for the purpose of communicating with and educating individuals with hearing impairments, are exempt from the requirements of this section.

[42 FR 9296, Feb. 15, 1977]

**§ 801.430 User labeling for menstrual tampons.**

(a) This section applies to scented or scented deodorized menstrual tampons as identified in § 884.5460 and unscented menstrual tampons as identified in § 884.5470 of this chapter.

(b) Data show that toxic shock syndrome (TSS), a rare but serious and sometimes fatal disease, is associated with the use of menstrual tampons. To protect the public and to minimize the serious adverse effects of TSS, menstrual tampons shall be labeled as set forth in paragraphs (c), (d), and (e) of this section and tested for absorbency as set forth in paragraph (f) of this section.

(c) If the information specified in paragraph (d) of this section is to be included as a package insert, the following alert statement shall appear prominently and legibly on the package label:

ATTENTION: Tampons are associated with Toxic Shock Syndrome (TSS). TSS is a rare but serious disease that may cause death. Read and save the enclosed information.

(d) The labeling of menstrual tampons shall contain the following consumer information prominently and legibly, in such terms as to render the information likely to be read and understood by the ordinary individual under customary conditions of purchase and use:

(1)(i) Warning signs of TSS, e.g., sudden fever (usually 102° or more) and vomiting, diarrhea, fainting or near fainting when standing up, dizziness, or a rash that looks like a sunburn;

(ii) What to do if these or other signs of TSS appear, including the need to remove the tampon at once and seek medical attention immediately;

(2) The risk of TSS to all women using tampons during their menstrual period, especially the reported higher risks to women under 30 years of age and teenage girls, the estimated incidence of TSS of 1 to 17 per 100,000 menstruating women and girls per year, and the risk of death from contracting TSS;

(3) The advisability of using tampons with the minimum absorbency needed to control menstrual flow in order to reduce the risk of contracting TSS;

(4) Avoiding the risk of getting tampon-associated TSS by not using tampons, and reducing the risk of getting TSS by alternating tampon use with sanitary napkin use during menstrual periods; and

(5) The need to seek medical attention before again using tampons if TSS warning signs have occurred in the past, or if women have any questions about TSS or tampon use.

(e) The statements required by paragraph (e) of this section shall be prominently and legibly placed on the package label of menstrual tampons in conformance with section 502(c) of the Federal Food, Drug, and Cosmetic Act (the act) (unless the menstrual tampons are exempt under paragraph (g) of this section).

(1) Menstrual tampon package labels shall bear one of the following absorbency terms representing the absorbency of the production run, lot, or

§ 801.430

21 CFR Ch. I (4-1-20 Edition)

batch as measured by the test described in paragraph (f)(2) of this section;

Ranges of absorbency in grams <sup>1</sup>	Corresponding term of absorbency
6 and under	Light absorbency
6 to 9	Regular absorbency
9 to 12	Super absorbency
12 to 15	Super plus absorbency
15 to 18	Ultra absorbency
Above 18	No term

<sup>1</sup>These ranges are defined, respectively, as follows: Less than or equal to 6 grams (g); greater than 6 g up to and including 9 g; greater than 9 g up to and including 12 g; greater than 12 g up to and including 15 g; greater than 15 g up to and including 18 g; and greater than 18 g.

(2) The package label shall include an explanation of the ranges of absorbency and a description of how consumers can use a range of absorbency, and its corresponding absorbency term, to make comparisons of absorbency of tampons to allow selection of the tampons with the minimum absorbency needed to control menstrual flow in order to reduce the risk of contracting TSS.

(f) A manufacturer shall measure the absorbency of individual tampons using the test method specified in paragraph (f)(2) of this section and calculate the mean absorbency of a production run, lot, or batch by rounding to the nearest 0.1 gram.

(1) A manufacturer shall design and implement a sampling plan that includes collection of probability samples of adequate size to yield consistent tolerance intervals such that the probability is 90 percent that at least 90 percent of the absorbencies of individual tampons within a brand and type are within the range of absorbency stated on the package label.

(2) In the absorbency test, an unlubricated condom, with tensile strength between 17 Mega Pascals

(MPa) and 30 MPa, as measured according to the procedure in the American Society for Testing and Materials (ASTM) D 3492-97, "Standard Specification for Rubber Contraceptives (Male Condoms)"<sup>1</sup> for determining tensile strength, which is incorporated by reference in accordance with 5 U.S.C. 552(a), is attached to the large end of a glass chamber (or a chamber made from hard transparent plastic) with a rubber band (see figure 1) and pushed through the small end of the chamber using a smooth, finished rod. The condom is pulled through until all slack is removed. The tip of the condom is cut off and the remaining end of the condom is stretched over the end of the tube and secured with a rubber band. A preweighed (to the nearest 0.01 gram) tampon is placed within the condom membrane so that the center of gravity of the tampon is at the center of the chamber. An infusion needle (14 gauge) is inserted through the septum created by the condom tip until it contacts the end of the tampon. The outer chamber is filled with water pumped from a temperature-controlled waterbath to maintain the average temperature at 27±1 °C. The water returns to the waterbath as shown in figure 2. Syngyna fluid (10 grams sodium chloride, 0.5 gram Certified Reagent Acid Fushsin, 1,000 milliliters distilled water) is then pumped through the infusion needle at a rate of 50 milliliters per hour. The test shall be terminated when the tampon is saturated and the first drop of fluid exits the apparatus. (The test result shall be discarded if fluid is detected in the folds of the condom before the tampon is saturated). The water is then drained and the tampon is removed and immediately weighed to the nearest 0.01 gram. The absorbency of the tampon is determined by subtracting its dry weight from this value. The condom shall be replaced after 10 tests or at the

<sup>1</sup>The Director of the Federal Register approves this incorporation by reference in accordance with 5 U.S.C. 552(a) and 1 CFR part 51. You may obtain a copy from the American Society for Testing and Materials International, 100 Barr Harbor Dr., P.O. Box C700, West Conshohocken, PA 19428-2959, 610-832-9578, [www.astm.org](http://www.astm.org). You may inspect a copy at the FDA Main Library, 10903 New Hamp-

shire Ave., Bldg. 2, 3d floor, Silver Spring, MD 20993-0002, 301-796-2039, or at the National Archives and Records Administration (NARA). For information on the availability of this material at NARA, call 202-741-2139, or go to: [http://www.archives.gov/federal\\_register/code\\_of\\_federal\\_regulations/ibr\\_locations.html](http://www.archives.gov/federal_register/code_of_federal_regulations/ibr_locations.html).

end of the day during which the condom is used in testing, whichever occurs first.

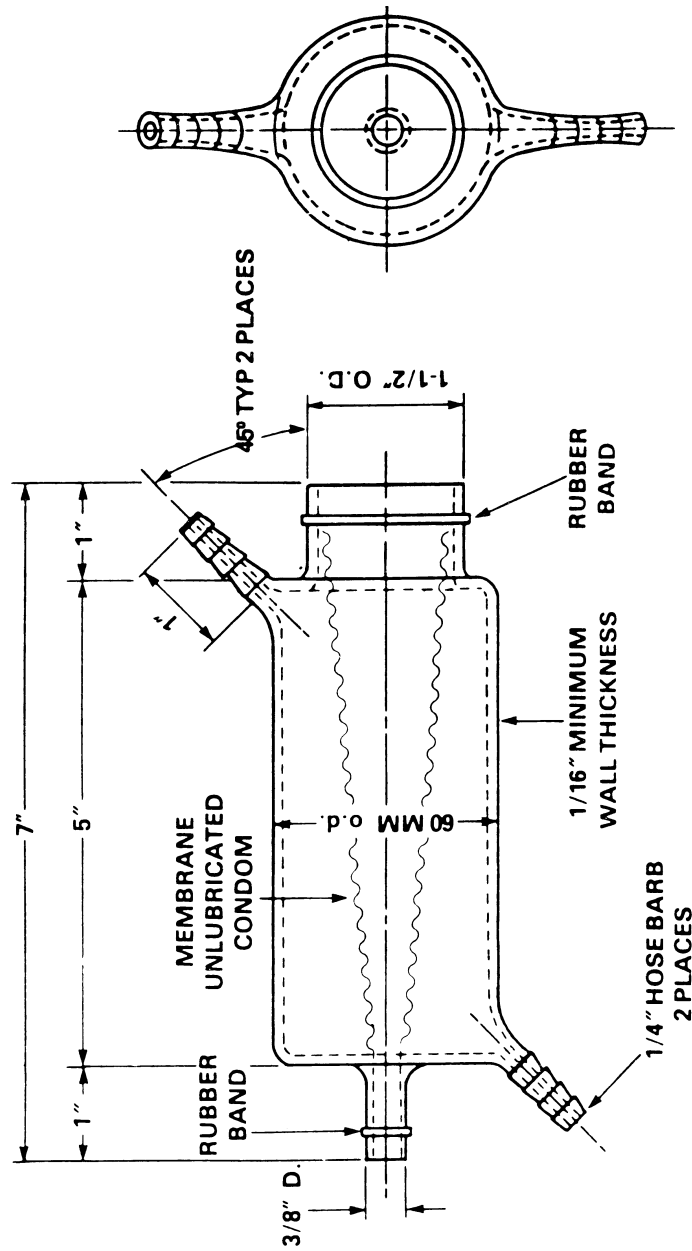

FIGURE 1 — SYNGYNA TEST CHAMBER

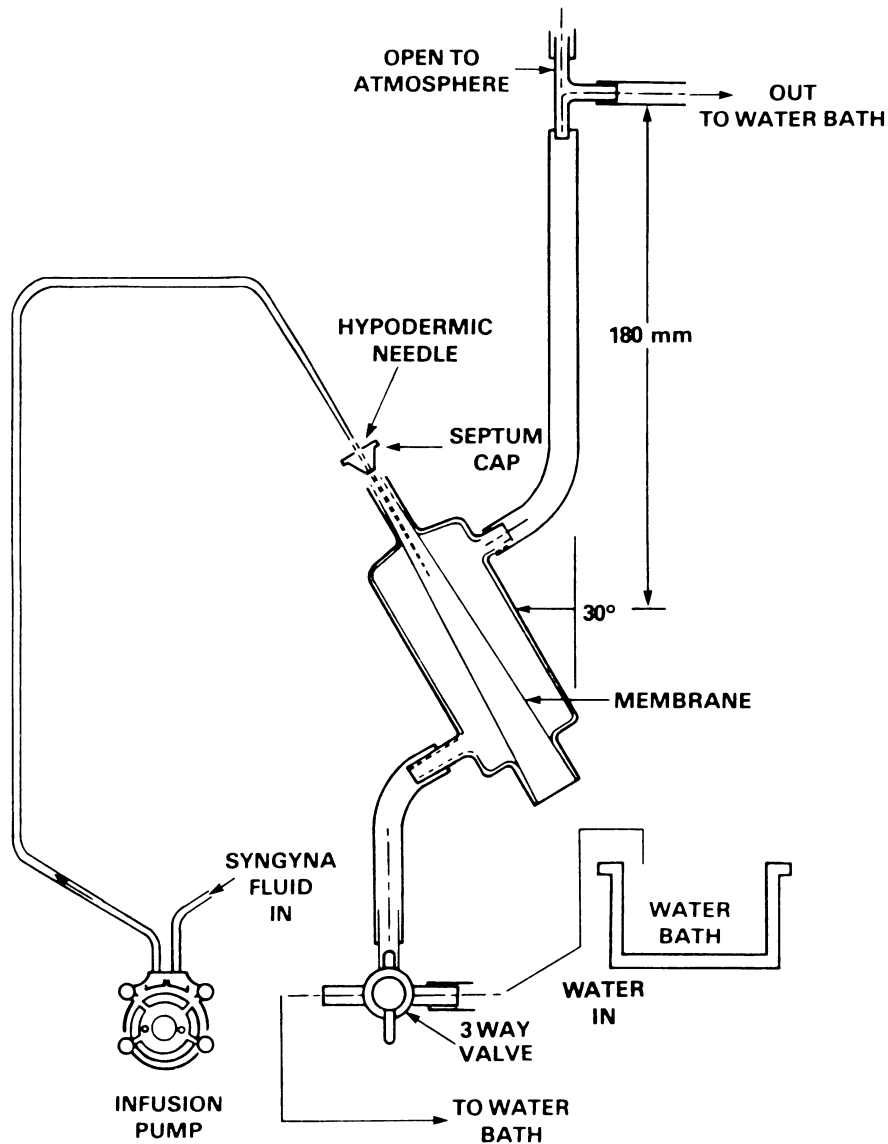

FIGURE 2—SYNGYNA TEST SET-UP

(3) The Food and Drug Administration may permit the use of an absorbency test method different from the

test method specified in this section if each of the following conditions is met:  
 (i) The manufacturer presents evidence, in the form of a citizen petition

submitted in accordance with the requirements of §10.30 of this chapter, demonstrating that the alternative test method will yield results that are equivalent to the results yielded by the test method specified in this section; and

(ii) FDA approves the method and has published notice of its approval of the alternative test method in the FEDERAL REGISTER.

(g) Any menstrual tampon intended to be dispensed by a vending machine is exempt from the requirements of this section.

(h) Any menstrual tampon that is not labeled as required by paragraphs (c), (d), and (e) of this section and that is initially introduced or initially delivered for introduction into commerce after March 1, 1990, is misbranded under sections 201(n), 502 (a) and (f) of the act.

(Information collection requirements contained in paragraphs (e) and (f) were approved by the Office of Management and Budget under control number 0910-0257)

[47 FR 26989, June 22, 1982, as amended at 54 FR 43771, Oct. 26, 1989; 55 FR 17600, Apr. 26, 1990; 65 FR 3586, Jan. 24, 2000; 65 FR 44436, July 18, 2000; 65 FR 62284, Oct. 18, 2000; 69 FR 18803, Apr. 9, 2004; 69 FR 52171, Aug. 25, 2004; 75 FR 20914, Apr. 22, 2010]

**§ 801.433 Warning statements for prescription and restricted device products containing or manufactured with chlorofluorocarbons or other ozone-depleting substances.**

(a)(1) All prescription and restricted device products containing or manufactured with chlorofluorocarbons, halons, carbon tetrachloride, methyl chloride, or any other class I substance designated by the Environmental Protection Agency (EPA) shall, except as provided in paragraph (b) of this section, bear the following warning statement:

WARNING: Contains [or Manufactured with, if applicable] *[insert name of substance]*, a substance which harms public health and environment by destroying ozone in the upper atmosphere.

(2) The warning statement shall be clearly legible and conspicuous on the product, its immediate container, its outer packaging, or other labeling in accordance with the requirements of 40 CFR part 82 and appear with such

prominence and conspicuousness as to render it likely to be read and understood by consumers under normal conditions of purchase.

(b)(1) For prescription and restricted device products, the following alternative warning statement may be used:

NOTE: The indented statement below is required by the Federal government's Clean Air Act for all products containing or manufactured with chlorofluorocarbons (CFC's) [or name of other class I substance, if applicable]:

This product contains [or is manufactured with, if applicable] *[insert name of substance]*, a substance which harms the environment by destroying ozone in the upper atmosphere.

Your physician has determined that this product is likely to help your personal health. USE THIS PRODUCT AS DIRECTED, UNLESS INSTRUCTED TO DO OTHERWISE BY YOUR PHYSICIAN. If you have any questions about alternatives, consult with your physician.

(2) The warning statement shall be clearly legible and conspicuous on the product, its immediate container, its outer packaging, or other labeling in accordance with the requirements of 40 CFR part 82 and appear with such prominence and conspicuousness as to render it likely to be read and understood by consumers under normal conditions of purchase.

(3) If the warning statement in paragraph (b)(1) of this section is used, the following warning statement must be placed on the package labeling intended to be read by the physician (physician package insert) after the "How supplied" section, which describes special handling and storage conditions on the physician labeling:

NOTE: The indented statement below is required by the Federal government's Clean Air Act for all products containing or manufactured with chlorofluorocarbons (CFC's) [or name of other class I substance, if applicable]:

WARNING: Contains [or Manufactured with, if applicable] *[insert name of substance]*, a substance which harms public health and environment by destroying ozone in the upper atmosphere.

A notice similar to the above WARNING has been placed in the information for the patient [or patient information leaflet, if applicable] of this product under Environmental Protection Agency (EPA) regulations. The patient's warning states that the

## § 801.435

## 21 CFR Ch. I (4–1–20 Edition)

patient should consult his or her physician if there are questions about alternatives.

(c) This section does not replace or relieve a person from any requirements imposed under 40 CFR part 82.

[61 FR 20101, May 3, 1996]

### § 801.435 User labeling for latex condoms.

(a) This section applies to the subset of condoms as identified in § 884.5300 of this chapter, and condoms with spermicidal lubricant as identified in § 884.5310 of this chapter, which products are formed from latex films.

(b) Data show that the material integrity of latex condoms degrade over time. To protect the public health and minimize the risk of device failure, latex condoms must bear an expiration date which is supported by testing as described in paragraphs (d) and (h) of this section.

(c) The expiration date, as demonstrated by testing procedures required by paragraphs (d) and (h) of this section, must be displayed prominently and legibly on the primary packaging (i.e., individual package), and higher levels of packaging (e.g., boxes of condoms), in order to ensure visibility of the expiration date by consumers.

(d) Except as provided under paragraph (f) of this section, the expiration date must be supported by data demonstrating physical and mechanical integrity of the product after three discrete and representative lots of the product have been subjected to each of the following conditions:

(1) Storage of unpackaged bulk product for the maximum amount of time the manufacturer allows the product to remain unpackaged, followed by storage of the packaged product at 70 °C (plus or minus 2 °C) for 7 days;

(2) Storage of unpackaged bulk product for the maximum amount of time the manufacturer allows the product to remain unpackaged, followed by storage of the packaged product at a selected temperature between 40 and 50 °C (plus or minus 2 °C) for 90 days; and

(3) Storage of unpackaged bulk product for the maximum amount of time the manufacturer allows the product to remain unpackaged, followed by storage of the packaged product at a monitored or controlled temperature be-

tween 15 and 30 °C for the lifetime of the product (real time storage).

(e) If a product fails the physical and mechanical integrity tests commonly used by industry after the completion of the accelerated storage tests described in paragraphs (d)(1) and (d)(2) of this section, the product expiration date must be demonstrated by real time storage conditions described in paragraph (d)(3) of this section. If all of the products tested after storage at temperatures as described in paragraphs (d)(1) and (d)(2) of this section pass the manufacturer's physical and mechanical integrity tests, the manufacturer may label the product with an expiration date of up to 5 years from the date of product packaging. If the extrapolated expiration date under paragraphs (d)(1) and (d)(2) of this section is used, the labeled expiration date must be confirmed by physical and mechanical integrity tests performed at the end of the stated expiration period as described in paragraph (d)(3) of this section. If the data from tests following real time storage described in paragraph (d)(3) of this section fails to confirm the extrapolated expiration date, the manufacturer must, at that time, relabel the product to reflect the actual shelf life.

(f) Products that already have established shelf life data based upon real time storage and testing and have such storage and testing data available for inspection are not required to confirm such data using accelerated and intermediate aging data described in paragraphs (d)(1) and (d)(2) of this section. If, however, such real time expiration dates were based upon testing of products that were not first left unpackaged for the maximum amount of time as described in paragraph (d)(3) of this section, the real time testing must be confirmed by testing products consistent with the requirements of paragraph (d)(3) of this section. This testing shall be initiated no later than the effective date of this regulation. Until the confirmation testing in accordance with paragraph (d)(3) of this section is completed, the product may remain on the market labeled with the expiration date based upon previous real time testing.



(g) If a manufacturer uses testing data from one product to support expiration dating on any variation of that product, the manufacturer must document and provide, upon request, an appropriate justification for the application of the testing data to the variation of the tested product.

(h) If a latex condom contains a spermicide, and the expiration date based on spermicidal stability testing is different from the expiration date based upon latex integrity testing, the product shall bear only the earlier expiration date.

(i) The time period upon which the expiration date is based shall start with the date of packaging.

(j) As provided in part 820 of this chapter, all testing data must be retained in each company's files, and shall be made available upon request for inspection by the Food and Drug Administration.

(k) Any latex condom not labeled with an expiration date as required by paragraph (c) of this section, and initially delivered for introduction into interstate commerce after the effective date of this regulation is misbranded under sections 201(n) and 502(a) and (f) of Federal Food, Drug, and Cosmetic Act (21 U.S.C. 321(n) and 352(a) and (f)).

[62 FR 50501, Sept. 26, 1997]

**§ 801.437 User labeling for devices that contain natural rubber.**

(a) Data in the Medical Device Reporting System and the scientific literature indicate that some individuals are at risk of severe anaphylactic reactions to natural latex proteins. This labeling regulation is intended to minimize the risk to individuals sensitive to natural latex proteins and protect the public health.

(b) This section applies to all devices composed of or containing, or having packaging or components that are composed of, or contain, natural rubber that contacts humans. The term "natural rubber" includes natural rubber latex, dry natural rubber, and synthetic latex or synthetic rubber that contains natural rubber in its formulation.

(1) The term "natural rubber latex" means rubber that is produced by the natural rubber latex process that in-

volves the use of natural latex in a concentrated colloidal suspension. Products are formed from natural rubber latex by dipping, extruding, or coating.

(2) The term "dry natural rubber" means rubber that is produced by the dry natural rubber process that involves the use of coagulated natural latex in the form of dried or milled sheets. Products are formed from dry natural rubber by compression molding, extrusion, or by converting the sheets into a solution for dipping.

(3) The term "contacts humans" means that the natural rubber contained in a device is intended to contact or is likely to contact the user or patient. This includes contact when the device that contains natural rubber is connected to the patient by a liquid path or an enclosed gas path; or the device containing the natural rubber is fully or partially coated with a powder, and such powder may carry natural rubber proteins that may contaminate the environment of the user or patient.

(c) Devices containing natural rubber shall be labeled as set forth in paragraphs (d) through (h) of this section. Each required labeling statement shall be prominently and legibly displayed in conformance with section 502(c) of the Federal Food, Drug, and Cosmetic Act (the act) (21 U.S.C. 352(c)).

(d) Devices containing natural rubber latex that contacts humans, as described in paragraph (b) of this section, shall bear the following statement in bold print on the device labeling:

"Caution: This Product Contains Natural Rubber Latex Which May Cause Allergic Reactions."

This statement shall appear on all device labels, and other labeling, and shall appear on the principal display panel of the device packaging, the outside package, container or wrapper, and the immediate device package, container, or wrapper.

(e) Devices containing dry natural rubber that contacts humans, as described in paragraph (b) of this section, that are not already subject to paragraph (d) of this section, shall bear the following statement in bold print on the device labeling:

"This Product Contains Dry Natural Rubber."

**Pt. 803**

This statement shall appear on all device labels, and other labeling, and shall appear on the principal display panel of the device packaging, the outside package, container or wrapper, and the immediate device package, container, or wrapper.

(f) Devices that have packaging containing natural rubber latex that contacts humans, as described in paragraph (b) of this section, shall bear the following statement in bold print on the device labeling:

“Caution: The Packaging of This Product Contains Natural Rubber Latex Which May Cause Allergic Reactions.”

This statement shall appear on the packaging that contains the natural rubber, and the outside package, container, or wrapper.

(g) Devices that have packaging containing dry natural rubber that contacts humans, as described in paragraph (b) of this section, shall bear the following statement in bold print on the device labeling:

“The Packaging of This Product Contains Dry Natural Rubber.”

This statement shall appear on the packaging that contains the natural rubber, and the outside package, container, or wrapper.

(h) Devices that contain natural rubber that contacts humans, as described in paragraph (b) of this section, shall not contain the term “hypoallergenic” on their labeling.

(i) Any affected person may request an exemption or variance from the requirements of this section by submitting a citizen petition in accordance with §10.30 of this chapter.

(j) Any device subject to this section that is not labeled in accordance with paragraphs (d) through (h) of this section and that is initially introduced or initially delivered for introduction into interstate commerce after the effective date of this regulation is misbranded under sections 201(n) and 502(a), (c), and (f) of the act (21 U.S.C. 321(n) and 352(a), (c), and (f)).

NOTE TO §801.437: Paragraphs (f) and (g) are stayed until June 27, 1999, as those regula-

**21 CFR Ch. I (4–1–20 Edition)**

tions relate to device packaging that uses “cold seal” adhesives.

[62 FR 51029, Sept. 30, 1997, as amended at 63 FR 46175, Aug. 31, 1998]

**PART 803—MEDICAL DEVICE REPORTING**

**Subpart A—General Provisions**

Sec.

- 803.1 What does this part cover?
- 803.3 How does FDA define the terms used in this part?
- 803.9 What information from the reports do we disclose to the public?
- 803.10 Generally, what are the reporting requirements that apply to me?
- 803.11 What form should I use to submit reports of individual adverse events and where do I obtain these forms?
- 803.12 How do I submit initial and supplemental or followup reports?
- 803.13 Do I need to submit reports in English?
- 803.15 How will I know if you require more information about my medical device report?
- 803.16 When I submit a report, does the information in my report constitute an admission that the device caused or contributed to the reportable event?
- 803.17 What are the requirements for developing, maintaining, and implementing written MDR procedures that apply to me?
- 803.18 What are the requirements for establishing and maintaining MDR files or records that apply to me?
- 803.19 Are there exemptions, variances, or alternative forms of adverse event reporting requirements?

**Subpart B—Generally Applicable Requirements for Individual Adverse Event Reports**

- 803.20 How do I complete and submit an individual adverse event report?
- 803.21 Where can I find the reporting codes for adverse events that I use with medical device reports?
- 803.22 What are the circumstances in which I am not required to file a report?
- 803.23 Where can I find information on how to prepare and submit an MDR in electronic format?

**Subpart C—User Facility Reporting Requirements**

- 803.30 If I am a user facility, what reporting requirements apply to me?
- 803.32 If I am a user facility, what information must I submit in my individual adverse event reports?

803.33 If I am a user facility, what must I include when I submit an annual report?

#### Subpart D—Importer Reporting Requirements

803.40 If I am an importer, what reporting requirements apply to me?

803.42 If I am an importer, what information must I submit in my individual adverse event reports?

#### Subpart E—Manufacturer Reporting Requirements

803.50 If I am a manufacturer, what reporting requirements apply to me?

803.52 If I am a manufacturer, what information must I submit in my individual adverse event reports?

803.53 If I am a manufacturer, in which circumstances must I submit a 5-day report?

803.56 If I am a manufacturer, in what circumstances must I submit a supplemental or followup report and what are the requirements for such reports?

803.58 Foreign manufacturers.

AUTHORITY: 21 U.S.C. 352, 360, 360i, 360j, 371, 374.

SOURCE: 79 FR 8846, Feb. 14, 2014, unless otherwise noted.

### Subpart A—General Provisions

#### § 803.1 What does this part cover?

(a) This part establishes the requirements for medical device reporting for device user facilities, manufacturers, importers, and distributors. If you are a device user facility, you must report deaths and serious injuries that a device has or may have caused or contributed to, establish and maintain adverse event files, and submit summary annual reports. If you are a manufacturer or importer, you must report deaths and serious injuries that your device has or may have caused or contributed to, you must report certain device malfunctions, and you must establish and maintain adverse event files. If you are a manufacturer, you must also submit specified followup. These reports help us to protect the public health by helping to ensure that devices are not adulterated or misbranded and are safe and effective for their intended use. If you are a medical device distributor, you must maintain records (files) of incidents, but you are not required to report these incidents.

(b) This part supplements and does not supersede other provisions of this chapter, including the provisions of part 820 of this chapter.

(c) References in this part to regulatory sections of the Code of Federal Regulations are to chapter I of title 21, unless otherwise noted.

#### § 803.3 How does FDA define the terms used in this part?

Some of the terms we use in this part are specific to medical device reporting and reflect the language used in the statute (law). Other terms are more general and reflect our interpretation of the law. This section defines the following terms as used in this part:

(a) *Ambulatory surgical facility (ASF)* means a distinct entity that operates for the primary purpose of furnishing same day outpatient surgical services to patients. An ASF may be either an independent entity (i.e., not a part of a provider of services or any other facility) or operated by another medical entity (e.g., under the common ownership, licensure, or control of an entity). An ASF is subject to this regulation regardless of whether it is licensed by a Federal, State, municipal, or local government or regardless of whether it is accredited by a recognized accreditation organization. If an adverse event meets the criteria for reporting, the ASF must report that event regardless of the nature or location of the medical service provided by the ASF.

(b) *Become aware* means that an employee of the entity required to report has acquired information that reasonably suggests a reportable adverse event has occurred.

(1) If you are a device user facility, you are considered to have “become aware” when medical personnel, as defined in this section, who are employed by or otherwise formally affiliated with your facility, obtain information about a reportable event.

(2) If you are a manufacturer, you are considered to have become aware of an event when any of your employees becomes aware of a reportable event that is required to be reported within 30 calendar days or that is required to be reported within 5 work days because we had requested reports in accordance with § 803.53(b). You are also considered

### § 803.3

### 21 CFR Ch. I (4–1–20 Edition)

to have become aware of an event when any of your employees with management or supervisory responsibilities over persons with regulatory, scientific, or technical responsibilities, or whose duties relate to the collection and reporting of adverse events, becomes aware, from any information, including any trend analysis, that a reportable MDR event or events necessitates remedial action to prevent an unreasonable risk of substantial harm to the public health.

(3) If you are an importer, you are considered to have become aware of an event when any of your employees becomes aware of a reportable event that is required to be reported by you within 30 days.

(c) *Caused or contributed* means that a death or serious injury was or may have been attributed to a medical device, or that a medical device was or may have been a factor in a death or serious injury, including events occurring as a result of:

- (1) Failure,
- (2) Malfunction,
- (3) Improper or inadequate design,
- (4) Manufacture,
- (5) Labeling, or
- (6) User error.

(d) *Device user facility* means a hospital, ambulatory surgical facility, nursing home, outpatient diagnostic facility, or outpatient treatment facility as defined in this section, which is not a physician's office, as defined in this section. School nurse offices and employee health units are not device user facilities.

(e) *Distributor* means any person (other than the manufacturer or importer) who furthers the marketing of a device from the original place of manufacture to the person who makes final delivery or sale to the ultimate user, but who does not repackage or otherwise change the container, wrapper, or labeling of the device or device package. If you repackage or otherwise change the container, wrapper, or labeling, you are considered a manufacturer as defined in this section.

(f) *Expected life of a device* means the time that a device is expected to remain functional after it is placed into use. Certain implanted devices have specified "end of life" (EOL) dates.

Other devices are not labeled as to their respective EOL, but are expected to remain operational through activities such as maintenance, repairs, or upgrades, for an estimated period of time.

(g) *FDA, we, us, or Agency* means the Food and Drug Administration.

(h) *Five-day report* means a medical device report that must be submitted by a manufacturer to us under § 803.53 within 5 work days.

(i) *Hospital* means a distinct entity that operates for the primary purpose of providing diagnostic, therapeutic (such as medical, occupational, speech, physical), surgical, and other patient services for specific and general medical conditions. Hospitals include general, chronic disease, rehabilitative, psychiatric, and other special-purpose facilities. A hospital may be either independent (e.g., not a part of a provider of services or any other facility) or may be operated by another medical entity (e.g., under the common ownership, licensure, or control of another entity). A hospital is covered by this regulation regardless of whether it is licensed by a Federal, State, municipal or local government or whether it is accredited by a recognized accreditation organization. If an adverse event meets the criteria for reporting, the hospital must report that event regardless of the nature or location of the medical service provided by the hospital.

(j) *Importer* means any person who imports a device into the United States and who furthers the marketing of a device from the original place of manufacture to the person who makes final delivery or sale to the ultimate user, but who does not repackage or otherwise change the container, wrapper, or labeling of the device or device package. If you repackage or otherwise change the container, wrapper, or labeling, you are considered a manufacturer as defined in this section.

(k) *Malfunction* means the failure of a device to meet its performance specifications or otherwise perform as intended. Performance specifications include all claims made in the labeling for the device. The intended performance of a device refers to the intended use for which the device is labeled or

marketed, as defined in §801.4 of this chapter.

(1) *Manufacturer* means any person who manufactures, prepares, propagates, compounds, assembles, or processes a device by chemical, physical, biological, or other procedure. The term includes any person who either:

(1) Repackages or otherwise changes the container, wrapper, or labeling of a device in furtherance of the distribution of the device from the original place of manufacture;

(2) Initiates specifications for devices that are manufactured by a second party for subsequent distribution by the person initiating the specifications;

(3) Manufactures components or accessories that are devices that are ready to be used and are intended to be commercially distributed and intended to be used as is, or are processed by a licensed practitioner or other qualified person to meet the needs of a particular patient; or

(4) Is the U.S. agent of a foreign manufacturer.

(m) *Manufacturer or importer report number*. This number uniquely identifies each individual adverse event report submitted by a manufacturer or importer. This number consists of the following three parts:

(1) The FDA registration number for the manufacturing site of the reported device, or the registration number for the importer. If the manufacturing site or the importer does not have an establishment registration number, we will assign a temporary MDR reporting number until the site is registered in accordance with part 807 of this chapter. We will inform the manufacturer or importer of the temporary MDR reporting number;

(2) The four-digit calendar year in which the report is submitted; and

(3) The five-digit sequence number of the reports submitted during the year, starting with 00001. (For example, the complete number will appear as follows: 1234567-2011-00001.)

(n) *MDR* means medical device report.

(o) *MDR reportable event (or reportable event)* means:

(1) An event that user facilities become aware of that reasonably sug-

gests that a device has or may have caused or contributed to a death or serious injury or

(2) An event that manufacturers or importers become aware of that reasonably suggests that one of their marketed devices:

(i) May have caused or contributed to a death or serious injury, or

(ii) Has malfunctioned and that the device or a similar device marketed by the manufacturer or importer would be likely to cause or contribute to a death or serious injury if the malfunction were to recur.

(p) *Medical personnel* means an individual who:

(1) Is licensed, registered, or certified by a State, territory, or other governing body, to administer health care;

(2) Has received a diploma or a degree in a professional or scientific discipline;

(3) Is an employee responsible for receiving medical complaints or adverse event reports; or

(4) Is a supervisor of these persons.

(q) *Nursing home* means:

(1) An independent entity (i.e., not a part of a provider of services or any other facility) or one operated by another medical entity (e.g., under the common ownership, licensure, or control of an entity) that operates for the primary purpose of providing:

(i) Skilled nursing care and related services for persons who require medical or nursing care;

(ii) Hospice care to the terminally ill; or

(iii) Services for the rehabilitation of the injured, disabled, or sick.

(2) A nursing home is subject to this regulation regardless of whether it is licensed by a Federal, State, municipal, or local government or whether it is accredited by a recognized accreditation organization. If an adverse event meets the criteria for reporting, the nursing home must report that event regardless of the nature or location of the medical service provided by the nursing home.

(r) *Outpatient diagnostic facility* means:

(1) A distinct entity that:

(i) Operates for the primary purpose of conducting medical diagnostic tests on patients,

§ 803.3

21 CFR Ch. I (4-1-20 Edition)

(ii) Does not assume ongoing responsibility for patient care, and

(iii) Provides its services for use by other medical personnel.

(2) Outpatient diagnostic facilities include outpatient facilities providing radiography, mammography, ultrasonography, electrocardiography, magnetic resonance imaging, computerized axial tomography, and in vitro testing. An outpatient diagnostic facility may be either independent (i.e., not a part of a provider of services or any other facility) or operated by another medical entity (e.g., under the common ownership, licensure, or control of an entity). An outpatient diagnostic facility is covered by this regulation regardless of whether it is licensed by a Federal, State, municipal, or local government or whether it is accredited by a recognized accreditation organization. If an adverse event meets the criteria for reporting, the outpatient diagnostic facility must report that event regardless of the nature or location of the medical service provided by the outpatient diagnostic facility.

(s) *Outpatient treatment facility* means a distinct entity that operates for the primary purpose of providing nonsurgical therapeutic (medical, occupational, or physical) care on an outpatient basis or in a home health care setting. Outpatient treatment facilities include ambulance providers, rescue services, and home health care groups. Examples of services provided by outpatient treatment facilities include the following: Cardiac defibrillation, chemotherapy, radiotherapy, pain control, dialysis, speech or physical therapy, and treatment for substance abuse. An outpatient treatment facility may be either independent (i.e., not a part of a provider of services or any other facility) or operated by another medical entity (e.g., under the common ownership, licensure, or control of an entity). An outpatient treatment facility is covered by this regulation regardless of whether it is licensed by a Federal, State, municipal, or local government or whether it is accredited by a recognized accreditation organization. If an adverse event meets the criteria for reporting, the outpatient treatment facility must report that event regard-

less of the nature or location of the medical service provided by the outpatient treatment facility.

(t) *Patient of the facility* means any individual who is being diagnosed or treated and/or receiving medical care at or under the control or authority of the facility. This includes employees of the facility or individuals affiliated with the facility who, in the course of their duties, suffer a device-related death or serious injury that has or may have been caused or contributed to by a device used at the facility.

(u) *Physician's office* means a facility that operates as the office of a physician or other health care professional for the primary purpose of examination, evaluation, and treatment or referral of patients. Examples of physician offices include: Dentist offices, chiropractor offices, optometrist offices, nurse practitioner offices, school nurse offices, school clinics, employee health clinics, or freestanding care units. A physician's office may be independent, a group practice, or part of a Health Maintenance Organization.

(v) *Remedial action* means any action other than routine maintenance or servicing of a device where such action is necessary to prevent recurrence of a reportable event.

(w) *Serious injury* means an injury or illness that:

- (1) Is life-threatening,
- (2) Results in permanent impairment of a body function or permanent damage to a body structure, or
- (3) Necessitates medical or surgical intervention to preclude permanent impairment of a body function or permanent damage to a body structure. Permanent means irreversible impairment or damage to a body structure or function, excluding trivial impairment or damage.

(x) *User facility report number* means the number that uniquely identifies each report submitted by a user facility to manufacturers and to us. This number consists of the following three parts:

- (1) The user facility's 10-digit Centers for Medicare and Medicaid Services (CMS) number (if the CMS number has fewer than 10 digits, fill the remaining spaces with zeros);

(2) The four-digit calendar year in which the report is submitted; and

(3) The four-digit sequence number of the reports submitted for the year, starting with 0001. (For example, a complete user facility report number will appear as follows: 1234560000-2011-0001. If a user facility has more than one CMS number, it must select one that will be used for all of its MDR reports. If a user facility has no CMS number, it should use all zeros in the appropriate space in its initial report (e.g., 0000000000-2011-0001). We will assign a number for future use and send that number to the user facility. This number is used in our record of the initial report, in subsequent reports, and in any correspondence with the user facility. If a facility has multiple sites, the primary site may submit reports for all sites and use one reporting number for all sites if the primary site provides the name, address, and CMS number for each respective site.)

(y) *Work day* means Monday through Friday, except Federal holidays.

(z) [Reserved]

(aa) *Human cell, tissue, or cellular or tissue-based product (HCT/P) regulated as a device* means an HCT/P as defined in §1271.3(d) of this chapter that does not meet the criteria in §1271.10(a) and that is also regulated as a device.

(bb) *Unique device identifier (UDI)* means an identifier that adequately identifies a device through its distribution and use by meeting the requirements of §830.20 of this chapter. A *unique device identifier* is composed of:

(1) A *device identifier*—a mandatory, fixed portion of a UDI that identifies the specific version or model of a device and the labeler of that device; and

(2) A *production identifier*—a conditional, variable portion of a UDI that identifies one or more of the following when included on the label of the device:

(i) The lot or batch within which a device was manufactured;

(ii) The serial number of a specific device;

(iii) The expiration date of a specific device;

(iv) The date a specific device was manufactured.

(v) For an HCT/P regulated as a device, the distinct identification code required by §1271.290(c) of this chapter.

[79 FR 8846, Feb. 14, 2014, as amended at 80 FR 10587, Feb. 27, 2015]

### § 803.9 What information from the reports do we disclose to the public?

(a) We may disclose to the public any report, including any FDA record of a telephone report, submitted under this part. Our disclosures are governed by part 20 of this chapter.

(b) Before we disclose a report to the public, we will delete the following:

(1) Any information that constitutes trade secret or confidential commercial or financial information under §20.61 of this chapter;

(2) Any personal, medical, and similar information, including the serial number of implanted devices, which would constitute an invasion of personal privacy under §20.63 of this chapter. However, if a patient requests a report, we will disclose to that patient all the information in the report concerning that patient, as provided in §20.61 of this chapter; and

(3) Any names and other identifying information of a third party that voluntarily submitted an adverse event report.

(c) We may not disclose the identity of a device user facility that makes a report under this part except in connection with:

(1) An action brought to enforce section 301(q) of the Federal Food, Drug, and Cosmetic Act (21 U.S.C. 331(q)), including the failure or refusal to furnish material or information required by section 519 of the Federal Food, Drug, and Cosmetic Act (21 U.S.C. 360i));

(2) A communication to a manufacturer of a device that is the subject of a report required to be submitted by a user facility under §803.30; or

(3) A disclosure to employees of the Department of Health and Human Services, to the Department of Justice, or to the duly authorized committees and subcommittees of the Congress.

## § 803.10

### § 803.10 Generally, what are the reporting requirements that apply to me?

(a) If you are a device user facility, you must submit reports (described in subpart C of this part), as follows:

(1) Submit reports of individual adverse events no later than 10 work days after the day that you become aware of a reportable event:

(i) Submit reports of device-related deaths to us and to the manufacturer, if known, or

(ii) Submit reports of device-related serious injuries to the manufacturers or, if the manufacturer is unknown, submit reports to us.

(2) Submit annual reports (described in § 803.33) to us.

(b) If you are an importer, you must submit reports (described in subpart D of this part), as follows:

(1) Submit reports of individual adverse events no later than 30 calendar days after the day that you become aware of a reportable event:

(i) Submit reports of device-related deaths or serious injuries to us and to the manufacturer or

(ii) Submit reports of device-related malfunctions to the manufacturer.

(2) [Reserved]

(c) If you are a manufacturer, you must submit reports (described in subpart E of this part) to us, as follows:

(1) Submit reports of individual adverse events no later than 30 calendar days after the day that you become aware of a reportable death, serious injury, or malfunction.

(2) Submit reports of individual adverse events no later than 5 work days after the day that you become aware of:

(i) A reportable event that requires remedial action to prevent an unreasonable risk of substantial harm to the public health or

(ii) A reportable event for which we made a written request.

(3) Submit supplemental reports if you obtain information that you did not submit in an initial report.

## 21 CFR Ch. I (4–1–20 Edition)

### § 803.11 What form should I use to submit reports of individual adverse events and where do I obtain these forms?

(a) If you are a manufacturer or importer, you must submit reports of individual adverse events to FDA in an electronic format in accordance with § 803.12(a) and § 803.20, unless granted an exemption under § 803.19.

(b) Importer reports submitted to device manufacturers may be in paper format or an electronic format that includes all required data fields to ensure that the manufacturer has all required information.

(c) If you are a user facility, you must submit reports of individual adverse events in accordance with § 803.12(b) and § 803.20.

(d) Form FDA 3500A is available on the Internet at <http://www.fda.gov/medwatch/getforms.htm> or from Division of International and Consumer Education, Center for Devices and Radiological Health, Food and Drug Administration, 10903 New Hampshire Ave., Bldg. 66, Rm. 4621, Silver Spring, MD 20993-0002, by email: [DICE@fda.hhs.gov](mailto:DICE@fda.hhs.gov), FAX: 301-847-8149, or telephone: 800-638-2041.

[79 FR 8846, Feb. 14, 2014, as amended at 80 FR 10587, Feb. 27, 2015]

### § 803.12 How do I submit initial and supplemental or followup reports?

(a) Manufacturers and importers must submit initial and supplemental or followup reports to FDA in an electronic format that FDA can process, review, and archive.

(b) User facilities that submit their reports and additional information to FDA electronically must use an electronic format that FDA can process, review, and archive. User facilities that submit their reports to FDA on paper must submit any written report or additional information required under this part to FDA, CDRH, Medical Device Reporting, P.O. Box 3002, Rockville, MD 20847-3002, using Form FDA 3500A. Each report must be identified (e.g., “User Facility Report” or “Annual Report”).

(c) If you are confronted with a public health emergency, this can be



brought to FDA's attention by contacting FDA's Office of Crisis Management, Emergency Operations Center by telephone, 24-hours a day, at 301-796-8240 or toll free at 866-300-4374, followed by the submission of an email to: *emergency.operations@fda.hhs.gov*.

NOTE: This action does not satisfy your obligation to report under part 803.

(d) You may submit a voluntary telephone report to the MedWatch office at 800-FDA-1088. You may also obtain information regarding voluntary reporting from the MedWatch office at 800-FDA-1088. You may also find the voluntary Form FDA 3500 and instructions to complete it at: *http://www.fda.gov/Safety/MedWatch/HowToReport/DownloadForms/default.htm*.

**§ 803.13 Do I need to submit reports in English?**

Yes. You must submit all reports required by this part in English.

**§ 803.15 How will I know if you require more information about my medical device report?**

(a) We will notify you in writing if we require additional information and will tell you what information we need. We will require additional information if we determine that protection of the public health requires additional or clarifying information for medical device reports submitted to us and in cases when the additional information is beyond the scope of FDA reporting forms or is not readily accessible to us.

(b) In any request under this section, we will state the reason or purpose for the information request, specify the due date for submitting the information, and clearly identify the reported event(s) related to our request. If we verbally request additional information, we will confirm the request in writing.

**§ 803.16 When I submit a report, does the information in my report constitute an admission that the device caused or contributed to the reportable event?**

No. A report or other information submitted by you, and our release of that report or information, is not necessarily an admission that the device, or you or your employees, caused or contributed to the reportable event.

You do not have to admit and may deny that the report or information submitted under this part constitutes an admission that the device, you, or your employees, caused or contributed to a reportable event.

**§ 803.17 What are the requirements for developing, maintaining, and implementing written MDR procedures that apply to me?**

If you are a user facility, importer, or manufacturer, you must develop, maintain, and implement written MDR procedures for the following:

(a) Internal systems that provide for:

(1) Timely and effective identification, communication, and evaluation of events that may be subject to MDR requirements;

(2) A standardized review process or procedure for determining when an event meets the criteria for reporting under this part; and

(3) Timely transmission of complete medical device reports to manufacturers or to us, or to both if required.

(b) Documentation and record-keeping requirements for:

(1) Information that was evaluated to determine if an event was reportable;

(2) All medical device reports and information submitted to manufacturers and/or us;

(3) Any information that was evaluated for the purpose of preparing the submission of annual reports; and

(4) Systems that ensure access to information that facilitates timely followup and inspection by us.

**§ 803.18 What are the requirements for establishing and maintaining MDR files or records that apply to me?**

(a) If you are a user facility, importer, or manufacturer, you must establish and maintain MDR event files. You must clearly identify all MDR event files and maintain them to facilitate timely access.

(b)(1) For purposes of this part, "MDR event files" are written or electronic files maintained by user facilities, importers, and manufacturers. MDR event files may incorporate references to other information (e.g., medical records, patient files, engineering reports), in lieu of copying and maintaining duplicates in this file. Your MDR event files must contain:

(i) Information in your possession or references to information related to the adverse event, including all documentation of your deliberations and decision making processes used to determine if a device-related death, serious injury, or malfunction was or was not reportable under this part;

(ii) Copies of all reports submitted under this part (whether paper or electronic), and of all other information related to the event that you submitted to us or other entities such as an importer, distributor, or manufacturer; and

(iii) Copies of all electronic acknowledgments FDA sends you in response to electronic MDR submissions.

(2) If you are a user facility, importer, or manufacturer, you must permit any authorized FDA employee, at all reasonable times, to access, to copy, and to verify the records required by this part.

(c) If you are a user facility, you must retain an MDR event file relating to an adverse event for a period of 2 years from the date of the event. If you are a manufacturer or importer, you must retain an MDR event file relating to an adverse event for a period of 2 years from the date of the event or a period of time equivalent to the expected life of the device, whichever is greater. If the device is no longer distributed, you still must maintain MDR event files for the time periods described in this paragraph (c).

(d)(1) If you are a device distributor, you must establish and maintain device complaint records (files). Your records must contain any incident information, including any written, electronic, or oral communication, either received or generated by you, that alleges deficiencies related to the identity (e.g., labeling), quality, durability, reliability, safety, effectiveness, or performance of a device. You must also maintain information about your evaluation of the allegations, if any, in the incident record. You must clearly identify the records as device incident records and file these records by device name. You may maintain these records in written or electronic format. You must back up any file maintained in electronic format.

(2) You must retain copies of the required device incident records for a period of 2 years from the date of inclusion of the record in the file or for a period of time equivalent to the expected life of the device, whichever is greater. You must maintain copies of these records for this period even if you no longer distribute the device.

(3) You must maintain the device complaint files established under this section at your principal business establishment. If you are also a manufacturer, you may maintain the file at the same location as you maintain your complaint file under part 820 of this chapter. You must permit any authorized FDA employee, at all reasonable times, to access, to copy, and to verify the records required by this part.

(e) If you are a manufacturer, you may maintain MDR event files as part of your complaint file, under part 820 of this chapter, if you prominently identify these records as MDR reportable events. We will not consider your submitted MDR report to comply with this part unless you evaluate an event in accordance with the quality system requirements described in part 820 of this chapter. You must document and maintain in your MDR event files an explanation of why you did not submit or could not obtain any information required by this part, as well as the results of your evaluation of each event.

**§ 803.19 Are there exemptions, variances, or alternative forms of adverse event reporting requirements?**

(a) We exempt the following persons from the adverse event reporting requirements in this part:

(1) A licensed practitioner who prescribes or administers devices intended for use in humans and manufactures or imports devices solely for use in diagnosing and treating persons with whom the practitioner has a “physician-patient” relationship;

(2) An individual who manufactures devices intended for use in humans solely for this person’s use in research or teaching and not for sale. This includes any person who is subject to alternative reporting requirements under the investigational device exemption regulations (described in part 812 of

this chapter), which require reporting of all adverse device effects; and

(3) Dental laboratories or optical laboratories.

(b) If you are a manufacturer, importer, or user facility, you may request an exemption or variance from any or all of the reporting requirements in this part, including the requirements of § 803.12. You must submit the request to us in writing at the following address: MDR Exemption Requests, Office of Surveillance and Biometrics, 10903 New Hampshire Ave., Bldg. 66, Rm. 3217, Silver Spring, MD 20993-0002. Your request must include information necessary to identify you and the device; a complete statement of the request for exemption, variance, or alternative reporting; and an explanation why your request is justified. If you are requesting an exemption from the requirement to submit reports to FDA in electronic format under § 803.12(a), your request should indicate for how long you will require this exemption.

(c) If you are a manufacturer, importer, or user facility, we may grant in writing an exemption or variance from, or alternative to, any or all of the reporting requirements in this part, and may change the frequency of reporting to quarterly, semiannually, annually or other appropriate time period. We may grant these modifications in response to your request, as described in paragraph (b) of this section, or at our discretion. When we grant modifications to the reporting requirements, we may impose other reporting requirements to ensure the protection of public health.

(d) We may revoke or modify in writing an exemption, variance, or alternative reporting requirement if we determine that revocation or modification is necessary to protect the public health.

(e) If we grant your request for a reporting modification, you must submit any reports or information required in our approval of the modification. The conditions of the approval will replace and supersede the regular reporting requirement specified in this part until such time that we revoke or modify the alternative reporting requirements in accordance with paragraph (d) of this

section or until the date specified in our response granting your variance, at which time the provisions of this part will again apply.

### Subpart B—Generally Applicable Requirements for Individual Adverse Event Reports

#### § 803.20 How do I complete and submit an individual adverse event report?

(a) *What form must I complete and submit?*

(1) If you are a health professional or consumer or other entity, you may submit voluntary reports to FDA regarding devices or other FDA-regulated products using the Form FDA 3500.

(2) To submit a mandatory report in written form, a user facility must use Form FDA 3500A.

(3) An electronic submission of a mandatory report from a user facility, importer, or manufacturer must contain the information from the applicable blocks of Form FDA 3500A. All electronic submissions must include information about the patient, the event, the device, and the “initial reporter.” An electronic submission from a user facility or importer must include the information from block F. An electronic submission from a manufacturer must include the information from blocks G and H. If you are a manufacturer and you receive a report from a user facility or importer, you must incorporate that information in your electronic submission and include any corrected or missing information.

(b) *To whom must I submit reports and when?*

(1) If you are a user facility, you must submit MDR reports to:

(i) The manufacturer and to us no later than 10 work days after the day that you become aware of information that reasonably suggests that a device has or may have caused or contributed to a death or

(ii) The manufacturer no later than 10 work days after the day that you become aware of information that reasonably suggests that a device has or may have caused or contributed to a serious injury. If the manufacturer is not known, you must submit this report to us.

## § 803.21

## 21 CFR Ch. I (4–1–20 Edition)

(2) If you are an importer, you must submit MDR reports to:

(i) The manufacturer and to us, no later than 30 calendar days after the day that you become aware of information that reasonably suggests that a device has or may have caused or contributed to a death or serious injury or

(ii) The manufacturer, no later than 30 calendar days after receiving information that a device you market has malfunctioned and that this device or a similar device that you market would be likely to cause or contribute to a death or serious injury if the malfunction were to recur.

(3) If you are a manufacturer, you must submit MDR reports to us:

(i) No later than 30 calendar days after the day that you become aware of information that reasonably suggests that a device may have caused or contributed to a death or serious injury or

(ii) No later than 30 calendar days after the day that you become aware of information that reasonably suggests a device has malfunctioned and that this device or a similar device that you market would be likely to cause or contribute to a death or serious injury if the malfunction were to recur; or

(iii) Within 5 work days if required by § 803.53.

(c) *What kind of information reasonably suggests that a reportable event has occurred?*

(1) Any information, including professional, scientific, or medical facts, observations, or opinions, may reasonably suggest that a device has caused or may have caused or contributed to an MDR reportable event. An MDR reportable event is a death, a serious injury, or, if you are a manufacturer or importer, a malfunction that would be likely to cause or contribute to a death or serious injury if the malfunction were to recur.

(2) If you are a user facility, importer, or manufacturer, you do not have to report an adverse event if you have information that would lead a person who is qualified to make a medical judgment reasonably to conclude that a device did not cause or contribute to a death or serious injury, or that a malfunction would not be likely to cause or contribute to a death or serious injury if it were to recur. Persons

qualified to make a medical judgment include physicians, nurses, risk managers, and biomedical engineers. You must keep in your MDR event files (described in § 803.18) the information that the qualified person used to determine whether or not a device-related event was reportable.

### **§ 803.21 Where can I find the reporting codes for adverse events that I use with medical device reports?**

(a) The MedWatch Medical Device Reporting Code Instruction Manual contains adverse event codes for use with Form FDA 3500A. You may obtain the coding manual from FDA's Web site at: <http://www.fda.gov/MedicalDevices/Safety/ReportaProblem/FormsandInstructions/default.htm>; and from the Division of Small Manufacturers, International and Consumer Assistance, Center for Devices and Radiological Health, 10903 New Hampshire Ave., Bldg. 66, Rm. 4621, Silver Spring, MD 20993-0002, FAX: 301-847-8149, or email to [DSMICA@fda.hhs.gov](mailto:DSMICA@fda.hhs.gov).

(b) We may sometimes use additional coding of information on the reporting forms or modify the existing codes. If we do make modifications, we will ensure that we make the new coding information available to all reporters.

### **§ 803.22 What are the circumstances in which I am not required to file a report?**

(a) If you become aware of information from multiple sources regarding the same patient and same reportable event, you may submit one medical device report.

(b) You are not required to submit a medical device report if:

(1) You are a user facility, importer, or manufacturer, and you determine that the information received is erroneous in that a device-related adverse event did not occur. You must retain documentation of these reports in your MDR files for the time periods specified in § 803.18.

(2) You are a manufacturer or importer and you did not manufacture or import the device about which you have adverse event information. When

you receive reportable event information in error, you must forward this information to us with a cover letter explaining that you did not manufacture or import the device in question.

**§ 803.23 Where can I find information on how to prepare and submit an MDR in electronic format?**

(a) You may obtain information on how to prepare and submit reports in an electronic format that FDA can process, review, and archive at: <http://www.fda.gov/ForIndustry/FDAeSubmitter/ucm107903.htm>.

(b) We may sometimes update information on how to prepare and submit reports electronically. If we do make modifications, we will ensure that we alert reporters by updating the eMDR Web page.

**Subpart C—User Facility Reporting Requirements**

**§ 803.30 If I am a user facility, what reporting requirements apply to me?**

(a) You must submit reports to the manufacturer or to us, or both, as specified in paragraphs (a)(1) and (a)(2) of this section as follows:

(1) *Reports of death.* You must submit a report to us as soon as practicable but no more than 10 work days after the day that you become aware of information, from any source, that reasonably suggests that a device has or may have caused or contributed to the death of a patient of your facility. You must also submit the report to the device manufacturer, if known. You must submit the information required by § 803.32. Reports sent to the Agency must be submitted in accordance with the requirements of § 803.12(b).

(2) *Reports of serious injury.* You must submit a report to the manufacturer of the device no later than 10 work days after the day that you become aware of information, from any source, that reasonably suggests that a device has or may have caused or contributed to a serious injury to a patient of your facility. If the manufacturer is not known, you must submit the report to us. You must report information required by § 803.32. Reports sent to the Agency must be submitted in accord-

ance with the requirements of § 803.12 (b).

(b) *What information does FDA consider “reasonably known” to me?* You must submit all information required in this subpart C that is reasonably known to you. This information includes information found in documents that you possess and any information that becomes available as a result of reasonable followup within your facility. You are not required to evaluate or investigate the event by obtaining or evaluating information that you do not reasonably know.

**§ 803.32 If I am a user facility, what information must I submit in my individual adverse event reports?**

You must include the following information in your report, if reasonably known to you, as described in § 803.30(b). These types of information correspond generally to the elements of Form FDA 3500A:

(a) Patient information (Form FDA 3500A, Block A). You must submit the following:

- (1) Patient name or other identifier;
- (2) Patient age at the time of event, or date of birth;
- (3) Patient gender; and
- (4) Patient weight.

(b) Adverse event or product problem (Form FDA 3500A, Block B). You must submit the following:

- (1) Identification of adverse event or product problem;
- (2) Outcomes attributed to the adverse event (e.g., death or serious injury). An outcome is considered a serious injury if it is:
  - (i) A life-threatening injury or illness;
  - (ii) A disability resulting in permanent impairment of a body function or permanent damage to a body structure; or
  - (iii) An injury or illness that requires intervention to prevent permanent impairment of a body structure or function;
- (3) Date of event;
- (4) Date of this report;

§ 803.33

21 CFR Ch. I (4–1–20 Edition)

(5) Description of event or problem, including a discussion of how the device was involved, nature of the problem, patient followup or required treatment, and any environmental conditions that may have influenced the event;

(6) Description of relevant tests, including dates and laboratory data; and

(7) Description of other relevant history, including preexisting medical conditions.

(c) Device information (Form FDA 3500A, Block D). You must submit the following:

(1) Brand name;

(2) Product Code, if known, and Common Device Name;

(3) Manufacturer name, city, and state;

(4) Model number, catalog number, serial number, lot number, or other identifying number; expiration date; and unique device identifier (UDI) that appears on the device label or on the device package;

(5) Operator of the device (health professional, lay user/patient, other);

(6) Date of device implantation (month, day, year), if applicable;

(7) Date of device explantation (month, day, year), if applicable;

(8) Whether the device is a single-use device that was reprocessed and reused on a patient (Yes, No)?

(9) If the device is a single-use device that was reprocessed and reused on a patient (yes to paragraph (c)(8) of this section), the name and address of the reprocessor;

(10) Whether the device was available for evaluation and whether the device was returned to the manufacturer; if so, the date it was returned to the manufacturer; and

(11) Concomitant medical products and therapy dates. (Do not report products that were used to treat the event.)

(d) Initial reporter information (Form FDA 3500A, Block E). You must submit the following:

(1) Name, address, and telephone number of the reporter who initially provided information to you, or to the manufacturer or distributor;

(2) Whether the initial reporter is a health professional;

(3) Occupation; and

(4) Whether the initial reporter also sent a copy of the report to us, if known.

(e) User facility information (Form FDA 3500A, Block F). You must submit the following:

(1) An indication that this is a user facility report (by marking the user facility box on the form);

(2) Your user facility number;

(3) Your address;

(4) Your contact person;

(5) Your contact person's telephone number;

(6) Date that you became aware of the event (month, day, year);

(7) Type of report (initial or followup); if it is a followup, you must include the report number of the initial report;

(8) Date of your report (month, day, year);

(9) Approximate age of device;

(10) Event problem codes—patient code and device code (refer to the “MedWatch Medical Device Reporting Code Instructions”);

(11) Whether a report was sent to us and the date it was sent (month, day, year);

(12) Location where the event occurred;

(13) Whether the report was sent to the manufacturer and the date it was sent (month, day, year); and

(14) Manufacturer name and address, if available.

[79 FR 8846, Feb. 14, 2014, as amended at 80 FR 10587, Feb. 27, 2015]

**§ 803.33 If I am a user facility, what must I include when I submit an annual report?**

(a) You must submit to us an annual report on Form FDA 3419. You must submit an annual report by January 1, of each year. You may obtain this form from the following sources:

(1) On the Internet at: <http://www.fda.gov/downloads/AboutFDA/ReportsManualsForms/Forms/UCM080796.pdf> or

(2) Division of International and Consumer Education, Center for Devices and Radiological Health, Food and Drug Administration, 10903 New Hampshire Ave., Bldg. 66, Rm. 4621, Silver Spring, MD 20993-0002, by email:

*DICE@fda.hhs.gov*, FAX: 301-847-8149, or telephone: 800-638-2041.

(b) You must clearly identify your annual report as such. You must submit your annual report to FDA, CDRH, Medical Device Reporting, P.O. Box 3002, Rockville, MD 20847-3002. Your annual report must include:

(1) Your CMS provider number used for medical device reports, or the number assigned by us for reporting purposes in accordance with § 803.3;

(2) Reporting year;

(3) Your name and complete address;

(4) Total number of reports attached or summarized;

(5) Date of the annual report and report numbers identifying the range of medical device reports that you submitted during the report period (e.g., 1234567890-2011-0001 through 1000);

(6) Name, position title, and complete address of the individual designated as your contact person responsible for reporting to us and whether that person is a new contact for you; and

(7) Information for each reportable event that occurred during the annual reporting period including:

(i) Report number;

(ii) Name and address of the device manufacturer;

(iii) Device brand name and common name;

(iv) Product model, catalog, serial, and lot number and unique device identifier (UDI) that appears on the device label or on the device package;

(v) A brief description of the event reported to the manufacturer and/or us; and

(vi) Where the report was submitted, i.e., to the manufacturer, importer, or us.

(c) In lieu of submitting the information in paragraph (b)(7) of this section, you may submit a copy of each medical device report that you submitted to the manufacturers and/or to us during the reporting period.

(d) If you did not submit any medical device reports to manufacturers or us during the time period, you do not need to submit an annual report.

[79 FR 8846, Feb. 14, 2014, as amended at 80 FR 10587, Feb. 27, 2015]

## Subpart D—Importer Reporting Requirements

### § 803.40 If I am an importer, what reporting requirements apply to me?

(a) *Reports of deaths or serious injuries.* You must submit a report to us, and a copy of this report to the manufacturer, as soon as practicable, but no later than 30 calendar days after the day that you receive or otherwise become aware of information from any source, including user facilities, individuals, or medical or scientific literature, whether published or unpublished, that reasonably suggests that one of your marketed devices may have caused or contributed to a death or serious injury. You must submit the information required by § 803.42. Reports sent to the Agency must be submitted in accordance with the requirements of § 803.12(a).

(b) *Reports of malfunctions.* You must submit a report to the manufacturer as soon as practicable but no later than 30 calendar days after the day that you receive or otherwise become aware of information from any source, including user facilities, individuals, or through your own research, testing, evaluation, servicing, or maintenance of one of your devices, that reasonably suggests that one of your devices has malfunctioned and that this device or a similar device that you market would be likely to cause or contribute to a death or serious injury if the malfunction were to recur. You must submit the information required by § 803.42. Reports to manufacturers may be made in accordance with § 803.11(b).

### § 803.42 If I am an importer, what information must I submit in my individual adverse event reports?

You must include the following information in your report, if the information is known or should be known to you, as described in § 803.40. These types of information correspond generally to the format of Form FDA 3500A:

(a) Patient information (Form FDA 3500A, Block A). You must submit the following:

(1) Patient name or other identifier;

(2) Patient age at the time of event, or date of birth;

- (3) Patient gender; and
- (4) Patient weight.
- (b) Adverse event or product problem (Form FDA 3500A, Block B). You must submit the following:
  - (1) Identification of adverse event or product problem;
  - (2) Outcomes attributed to the adverse event (e.g., death or serious injury). An outcome is considered a serious injury if it is:
    - (i) A life-threatening injury or illness;
    - (ii) A disability resulting in permanent impairment of a body function or permanent damage to a body structure; or
    - (iii) An injury or illness that requires intervention to prevent permanent impairment of a body structure or function;
  - (3) Date of event;
  - (4) Date of this report;
  - (5) Description of the event or problem, including a discussion of how the device was involved, nature of the problem, patient followup or required treatment, and any environmental conditions that may have influenced the event;
  - (6) Description of relevant tests, including dates and laboratory data; and
  - (7) Description of other relevant patient history, including preexisting medical conditions.
- (c) Device information (Form FDA 3500A, Block D). You must submit the following:
  - (1) Brand name;
  - (2) Product Code, if known, and Common Device Name;
  - (3) Manufacturer name, city, and state;
  - (4) Model number, catalog number, serial number, lot number, or other identifying number; expiration date; and unique device identifier (UDI) that appears on the device label or on the device package;
  - (5) Operator of the device (health professional, lay user/patient, other);
  - (6) Date of device implantation (month, day, year), if applicable;
  - (7) Date of device explanation (month, day, year), if applicable;
  - (8) Whether the device is a single-use device that was reprocessed and reused on a patient (Yes, No)?
  - (9) If the device is a single-use device that was reprocessed and reused on a patient (yes to paragraph (c)(8) of this section), the name and address of the reprocessor;
  - (10) Whether the device was available for evaluation, and whether the device was returned to the manufacturer, and if so, the date it was returned to the manufacturer; and
  - (11) Concomitant medical products and therapy dates. (Do not report products that were used to treat the event.)
- (d) Initial reporter information (Form FDA 3500A, Block E). You must submit the following:
  - (1) Name, address, and telephone number of the reporter who initially provided information to the manufacturer, user facility, or distributor;
  - (2) Whether the initial reporter is a health professional;
  - (3) Occupation; and
  - (4) Whether the initial reporter also sent a copy of the report to us, if known.
- (e) Importer information (Form FDA 3500A, Block F). You must submit the following:
  - (1) An indication that this is an importer report (by marking the importer box on the form);
  - (2) Your importer report number;
  - (3) Your address;
  - (4) Your contact person;
  - (5) Your contact person's telephone number;
  - (6) Date that you became aware of the event (month, day, year);
  - (7) Type of report (initial or followup). If it is a followup report, you must include the report number of your initial report;
  - (8) Date of your report (month, day, year);
  - (9) Approximate age of device;
  - (10) Event problem codes—patient code and device code (refer to FDA MedWatch Medical Device Reporting Code Instructions);
  - (11) Whether a report was sent to us and the date it was sent (month, day, year);
  - (12) Location where event occurred;
  - (13) Whether a report was sent to the manufacturer and the date it was sent (month, day, year); and



(14) Manufacturer name and address, if available.

[79 FR 8846, Feb. 14, 2014, as amended at 80 FR 10587, Feb. 27, 2015]

### Subpart E—Manufacturer Reporting Requirements

#### § 803.50 If I am a manufacturer, what reporting requirements apply to me?

(a) If you are a manufacturer, you must report to us the information required by § 803.52 in accordance with the requirements of § 803.12(a), no later than 30 calendar days after the day that you receive or otherwise become aware of information, from any source, that reasonably suggests that a device that you market:

(1) May have caused or contributed to a death or serious injury or

(2) Has malfunctioned and this device or a similar device that you market would be likely to cause or contribute to a death or serious injury, if the malfunction were to recur.

(b) What information does FDA consider “reasonably known” to me?

(1) You must submit all information required in this subpart E that is reasonably known to you. We consider the following information to be reasonably known to you:

(i) Any information that you can obtain by contacting a user facility, importer, or other initial reporter;

(ii) Any information in your possession; or

(iii) Any information that you can obtain by analysis, testing, or other evaluation of the device.

(2) You are responsible for obtaining and submitting to us information that is incomplete or missing from reports submitted by user facilities, importers, and other initial reporters.

(3) You are also responsible for conducting an investigation of each event and evaluating the cause of the event. If you cannot submit complete information on a report, you must provide a statement explaining why this information was incomplete and the steps you took to obtain the information. If you later obtain any required information that was not available at the time you filed your initial report, you must submit this information in a supple-

mental report under § 803.56 in accordance with the requirements of § 803.12(a).

#### § 803.52 If I am a manufacturer, what information must I submit in my individual adverse event reports?

You must include the following information in your reports, if known or reasonably known to you, as described in § 803.50(b). These types of information correspond generally to the format of Form FDA 3500A:

(a) Patient information (Form FDA 3500A, Block A). You must submit the following:

(1) Patient name or other identifier;

(2) Patient age at the time of event, or date of birth;

(3) Patient gender; and

(4) Patient weight.

(b) Adverse event or product problem (Form FDA 3500A, Block B). You must submit the following:

(1) Identification of adverse event or product problem;

(2) Outcomes attributed to the adverse event (e.g., death or serious injury). An outcome is considered a serious injury if it is:

(i) A life-threatening injury or illness;

(ii) A disability resulting in permanent impairment of a body function or permanent damage to a body structure; or

(iii) An injury or illness that requires intervention to prevent permanent impairment of a body structure or function;

(3) Date of event;

(4) Date of this report;

(5) Description of the event or problem, including a discussion of how the device was involved, nature of the problem, patient followup or required treatment, and any environmental conditions that may have influenced the event;

(6) Description of relevant tests, including dates and laboratory data; and

(7) Other relevant patient history including preexisting medical conditions.

(c) Device information (Form FDA 3500A, Block D). You must submit the following:

(1) Brand name;

(2) Product Code, if known, and Common Device Name;

§ 803.52

21 CFR Ch. I (4–1–20 Edition)

(3) Manufacturer name, city, and state;

(4) Model number, catalog number, serial number, lot number, or other identifying number; expiration date; and unique device identifier (UDI) that appears on the device label or on the device package;

(5) Operator of the device (health professional, lay user/patient, other);

(6) Date of device implantation (month, day, year), if applicable;

(7) Date of device explantation (month, day, year), if applicable;

(8) Whether the device is a single-use device that was reprocessed and reused on a patient (Yes, No)?

(9) If the device is a single-use device that was reprocessed and reused on a patient (yes to paragraph (c)(8) of this section), the name and address of the reprocessor;

(10) Whether the device was available for evaluation, and whether the device was returned to the manufacturer, and if so, the date it was returned to the manufacturer; and

(11) Concomitant medical products and therapy dates. (Do not report products that were used to treat the event.)

(d) Initial reporter information (Form FDA 3500A, Block E). You must submit the following:

(1) Name, address, and telephone number of the reporter who initially provided information to you, or to the user facility or importer;

(2) Whether the initial reporter is a health professional;

(3) Occupation; and

(4) Whether the initial reporter also sent a copy of the report to us, if known.

(e) Reporting information for all manufacturers (Form FDA 3500A, Block G). You must submit the following:

(1) Your reporting office's contact name and address and device manufacturing site;

(2) Your contact person's telephone number;

(3) Your report sources;

(4) Date received by you (month, day, year);

(5) PMA/510k Number and whether or not the product is a combination product;

(6) Type of report being submitted (e.g., 5-day, initial, followup); and

(7) Your report number.

(f) Device manufacturer information (Form FDA 3500A, Block H). You must submit the following:

(1) Type of reportable event (death, serious injury, malfunction, etc.);

(2) Type of followup report, if applicable (e.g., correction, response to FDA request, etc);

(3) If the device was returned to you and evaluated by you, you must include a summary of the evaluation. If you did not perform an evaluation, you must explain why you did not perform an evaluation;

(4) Device manufacture date (month, day, year);

(5) Whether the device was labeled for single use;

(6) Evaluation codes (including event codes, method of evaluation, result, and conclusion codes) (refer to FDA MedWatch Medical Device Reporting Code Instructions);

(7) Whether remedial action was taken and the type of action;

(8) Whether the use of the device was initial, reuse, or unknown;

(9) Whether remedial action was reported as a removal or correction under section 519(f) of the Federal Food, Drug, and Cosmetic Act, and if it was, provide the correction/removal report number; and

(10) Your additional narrative; and/or (11) Corrected data, including:

(i) Any information missing on the user facility report or importer report, including any event codes that were not reported, or information corrected on these forms after your verification;

(ii) For each event code provided by the user facility under §803.32(e)(10) or the importer under §803.42(e)(10), you must include a statement of whether the type of the event represented by the code is addressed in the device labeling; and

(iii) If your report omits any required information, you must explain why this information was not provided and the steps taken to obtain this information.

[79 FR 8846, Feb. 14, 2014, as amended at 80 FR 10587, Feb. 27, 2015]

**§ 803.53 If I am a manufacturer, in which circumstances must I submit a 5-day report?**

You must submit a 5-day report to us with the information required by § 803.52 in accordance with the requirements of § 803.12(a) no later than 5 work days after the day that you become aware that:

(a) An MDR reportable event necessitates remedial action to prevent an unreasonable risk of substantial harm to the public health. You may become aware of the need for remedial action from any information, including any trend analysis or

(b) We have made a written request for the submission of a 5-day report. If you receive such a written request from us, you must submit, without further requests, a 5-day report for all subsequent events of the same nature that involve substantially similar devices for the time period specified in the written request. We may extend the time period stated in the original written request if we determine it is in the interest of the public health.

**§ 803.56 If I am a manufacturer, in what circumstances must I submit a supplemental or followup report and what are the requirements for such reports?**

If you are a manufacturer, when you obtain information required under this part that you did not provide because it was not known or was not available when you submitted the initial report, you must submit the supplemental information to us within 30 calendar days of the day that you receive this information. You must submit the supplemental or followup report in accordance with the requirements of § 803.12(a). On a supplemental or followup report, you must:

(a) Indicate that the report being submitted is a supplemental or followup report;

(b) Submit the appropriate identification numbers of the report that you are updating with the supplemental information (e.g., your original manufacturer report number and the user facility or importer report number of any report on which your report was based), if applicable; and

(c) Include only the new, changed, or corrected information.

**§ 803.58 Foreign manufacturers.**

(a) Every foreign manufacturer whose devices are distributed in the United States shall designate a U.S. agent to be responsible for reporting in accordance with § 807.40 of this chapter. The U.S. designated agent accepts responsibility for the duties that such designation entails. Upon the effective date of this regulation, foreign manufacturers shall inform FDA, by letter, of the name and address of the U.S. agent designated under this section and § 807.40 of this chapter, and shall update this information as necessary. Such updated information shall be submitted to FDA, within 5 days of a change in the designated agent information.

(b) U.S.-designated agents of foreign manufacturers are required to:

(1) Report to FDA in accordance with §§ 803.50, 803.52, 803.53, and 803.56;

(2) Conduct, or obtain from the foreign manufacturer the necessary information regarding, the investigation and evaluation of the event to comport with the requirements of § 803.50;

(3) Forward MDR complaints to the foreign manufacturer and maintain documentation of this requirement;

(4) Maintain complaint files in accordance with § 803.18; and

(5) Register, list, and submit pre-market notifications in accordance with part 807 of this chapter.

EFFECTIVE DATE NOTE: At 79 FR 8846, Feb. 14, 2014, part 803 was revised. At 79 FR 8855, Feb. 14, 2014, § 803.58 was stayed indefinitely.

**PART 806—MEDICAL DEVICES; REPORTS OF CORRECTIONS AND REMOVALS**

**Subpart A—General Provisions**

- Sec.  
806.1 Scope.  
806.2 Definitions.

**Subpart B—Reports and Records**

- 806.10 Reports of corrections and removals.  
806.20 Records of corrections and removals not required to be reported.  
806.30 FDA access to records.  
806.40 Public availability of reports.

## § 806.1

## 21 CFR Ch. I (4–1–20 Edition)

AUTHORITY: 21 U.S.C. 352, 360, 360i, 360j, 371, 374.

SOURCE: 62 FR 27191, May 19, 1997, unless otherwise noted.

### Subpart A—General Provisions

#### § 806.1 Scope.

(a) This part implements the provisions of section 519(g) of the Federal Food, Drug, and Cosmetic Act (the act) requiring device manufacturers and importers to report promptly to the Food and Drug Administration (FDA) certain actions concerning device corrections and removals, and to maintain records of all corrections and removals regardless of whether such corrections and removals are required to be reported to FDA.

(b) The following actions are exempt from the reporting requirements of this part:

(1) Actions taken by device manufacturers or importers to improve the performance or quality of a device but that do not reduce a risk to health posed by the device or remedy a violation of the act caused by the device.

(2) Market withdrawal as defined in § 806.2(i)

(3) Routine servicing as defined in § 806.2(l).

(4) Stock recovery as defined in § 806.2(m).

[62 FR 27191, May 19, 1997, as amended at 63 FR 42232, Aug. 7, 1998; 84 FR 12083, Apr. 1, 2019]

#### § 806.2 Definitions.

As used in this part:

(a) *Act* means the Federal Food, Drug, and Cosmetic Act.

(b) *Agency* or *FDA* means the Food and Drug Administration.

(c) *Consignee* means any person or firm that has received, purchased, or used a device subject to correction or removal.

(d) *Correction* means the repair, modification, adjustment, relabeling, destruction, or inspection (including patient monitoring) of a device without its physical removal from its point of use to some other location.

(e) *Correction or removal report number* means the number that uniquely identifies each report submitted.

(f) *Human cell, tissue, or cellular or tissue-based product (HCT/P) regulated as a device* means an HCT/P as defined in § 1271.3(d) of this chapter that does not meet the criteria in § 1271.10(a) and that is also regulated as a device.

(g) *Importer* means, for the purposes of this part, any person who imports a device into the United States.

(h) *Manufacturer* means any person who manufactures, prepares, propagates, compounds, assembles, or processes a device by chemical, physical, biological, or other procedures. The term includes any person who:

(1) Repackages or otherwise changes the container, wrapper, or labeling of a device in furtherance of the distribution of the device from the original place of manufacture to the person who makes final delivery or sale to the ultimate user or consumer;

(2) Initiates specifications for devices that are manufactured by a second party for subsequent distribution by the person initiating the specifications; or

(3) Manufactures components or accessories which are devices that are ready to be used and are intended to be commercially distributed and are intended to be used as is, or are processed by a licensed practitioner or other qualified person to meet the needs of a particular patient.

(i) *Market withdrawal* means a correction or removal of a distributed device that involves a minor violation of the act that would not be subject to legal action by FDA or that involves no violation of the act, e.g., normal stock rotation practices.

(j) *Removal* means the physical removal of a device from its point of use to some other location for repair, modification, adjustment, relabeling, destruction, or inspection.

(k) *Risk to health* means

(1) A reasonable probability that use of, or exposure to, the product will cause serious adverse health consequences or death; or

(2) That use of, or exposure to, the product may cause temporary or medically reversible adverse health consequences, or an outcome where the probability of serious adverse health consequences is remote.

(l) *Routine servicing* means any regularly scheduled maintenance of a device, including the replacement of parts at the end of their normal life expectancy, e.g., calibration, replacement of batteries, and responses to normal wear and tear. Repairs of an unexpected nature, replacement of parts earlier than their normal life expectancy, or identical repairs or replacements of multiple units of a device are not routine servicing.

(m) *Stock recovery* means the correction or removal of a device that has not been marketed or that has not left the direct control of the manufacturer, i.e., the device is located on the premises owned, or under the control of, the manufacturer, and no portion of the lot, model, code, or other relevant unit involved in the corrective or removal action has been released for sale or use.

(n) *Unique device identifier (UDI)* means an identifier that adequately identifies a device through its distribution and use by meeting the requirements of § 830.20 of this chapter. A UDI is composed of:

(1) A *device identifier*—a mandatory, fixed portion of a UDI that identifies the specific version or model of a device and the labeler of that device; and

(2) A *production identifier*—a conditional, variable portion of a UDI that identifies one or more of the following when included on the label of the device:

(i) The lot or batch within which a device was manufactured;

(ii) The serial number of a specific device;

(iii) The expiration date of a specific device;

(iv) The date a specific device was manufactured.

(v) For an HCT/P regulated as a device, the distinct identification code required by § 1271.290(c) of this chapter.

[62 FR 27191, May 19, 1997, as amended at 63 FR 42232, Aug. 7, 1998; 78 FR 58821, Sept. 24, 2013]

### Subpart B—Reports and Records

#### § 806.10 Reports of corrections and removals.

(a) Each device manufacturer or importer shall submit a written report to FDA of any correction or removal of a

device initiated by such manufacturer or importer if the correction or removal was initiated:

(1) To reduce a risk to health posed by the device; or

(2) To remedy a violation of the act caused by the device which may present a risk to health unless the information has already been provided as set forth in paragraph (f) of this section or the corrective or removal action is exempt from the reporting requirements under § 806.1(b).

(b) The manufacturer or importer shall submit any report required by paragraph (a) of this section within 10-working days of initiating such correction or removal.

(c) The manufacturer or importer shall include the following information in the report:

(1) The seven digit registration number of the entity responsible for submission of the report of corrective or removal action (if applicable), the month, day, and year that the report is made, and a sequence number (i.e., 001 for the first report, 002 for the second report, 003 etc.), and the report type designation “C” or “R”. For example, the complete number for the first correction report submitted on June 1, 1997, will appear as follows for a firm with the registration number 1234567: 1234567-6/1/97-001-C. The second correction report number submitted by the same firm on July 1, 1997, would be 1234567-7/1/97-002-C etc. For removals, the number will appear as follows: 1234567-6/1/97-001-R and 1234567-7/1/97-002-R, etc. Firms that do not have a seven digit registration number may use seven zeros followed by the month, date, year, and sequence number (i.e. 0000000-6/1/97-001-C for corrections and 0000000-7/1/97-001-R for removals). Reports received without a seven digit registration number will be assigned a seven digit central file number by the district office reviewing the reports.

(2) The name, address, and telephone number of the manufacturer or importer, and the name, title, address, and telephone number of the manufacturer or importer representative responsible for conducting the device correction or removal.

(3) The brand name and the common name, classification name, or usual

**§ 806.20**

**21 CFR Ch. I (4–1–20 Edition)**

name of the device and the intended use of the device.

(4) Marketing status of the device, i.e., any applicable premarket notification number, premarket approval number, or indication that the device is a preamendments device, and the device listing number. A manufacturer or importer that does not have an FDA establishment registration number shall indicate in the report whether it has ever registered with FDA.

(5) The unique device identifier (UDI) that appears on the device label or on the device package, or the device identifier, universal product code (UPC), model, catalog, or code number of the device and the manufacturing lot or serial number of the device or other identification number.

(6) The manufacturer's name, address, telephone number, and contact person if different from that of the person submitting the report.

(7) A description of the event(s) giving rise to the information reported and the corrective or removal actions that have been, and are expected to be taken.

(8) Any illness or injuries that have occurred with use of the device. If applicable, include the medical device report numbers.

(9) The total number of devices manufactured or distributed subject to the correction or removal and the number in the same batch, lot, or equivalent unit of production subject to the correction or removal.

(10) The date of manufacture or distribution and the device's expiration date or expected life.

(11) The names, addresses, and telephone numbers of all domestic and foreign consignees of the device and the dates and number of devices distributed to each such consignee.

(12) A copy of all communications regarding the correction or removal and the names and addresses of all recipients of the communications not provided in accordance with paragraph (c)(11) of this section.

(13) If any required information is not immediately available, a statement as to why it is not available and when it will be submitted.

(d) If, after submitting a report under this part, a manufacturer or importer

determines that the same correction or removal should be extended to additional lots or batches of the same device, the manufacturer or importer shall within 10-working days of initiating the extension of the correction or removal, amend the report by submitting an amendment citing the original report number assigned according to paragraph (c)(1) of this section, all of the information required by paragraph (c)(2), and any information required by paragraphs (c)(3) through (c)(12) of this section that is different from the information submitted in the original report. The manufacturer or importer shall also provide a statement in accordance with paragraph (c)(13) of this section for any required information that is not readily available.

(e) A report submitted by a manufacturer or importer under this section (and any release by FDA of that report or information) does not necessarily reflect a conclusion by the manufacturer, importer, or FDA that the report or information constitutes an admission that the device caused or contributed to a death or serious injury. A manufacturer or importer need not admit, and may deny, that the report or information submitted under this section constitutes an admission that the device caused or contributed to a death or serious injury.

(f) No report of correction or removal is required under this part, if a report of the correction or removal is required and has been submitted under parts 803 or 1004 of this chapter.

[62 FR 27191, May 19, 1997, as amended at 63 FR 42232, Aug. 7, 1998; 69 FR 11311, Mar. 10, 2004; 78 FR 58821, Sept. 24, 2013]

**§ 806.20 Records of corrections and removals not required to be reported.**

(a) Each device manufacturer or importer who initiates a correction or removal of a device that is not required to be reported to FDA under §806.10 shall keep a record of such correction or removal.

(b) Records of corrections and removals not required to be reported to FDA under §806.10 shall contain the following information:

(1) The brand name, common or usual name, classification, name and product

code if known, and the intended use of the device.

(2) The unique device identifier (UDI) of the device, or the device identifier, universal product code (UPC), model, catalog, or code number of the device and the manufacturing lot or serial number of the device or other identification number.

(3) A description of the event(s) giving rise to the information reported and the corrective or removal action that has been, and is expected to be taken.

(4) Justification for not reporting the correction or removal action to FDA, which shall contain conclusions and any followups, and be reviewed and evaluated by a designated person.

(5) A copy of all communications regarding the correction or removal.

(c) The manufacturer or importer shall retain records required under this section for a period of 2 years beyond the expected life of the device, even if the manufacturer or importer has ceased to manufacture or import the device. Records required to be maintained under paragraph (b) of this section must be transferred to the new manufacturer or importer of the device and maintained for the required period of time.

[62 FR 27191, May 19, 1997, as amended at 63 FR 42233, Aug. 7, 1998; 78 FR 58821, Sept. 24, 2013]

#### § 806.30 FDA access to records.

Each device manufacturer or importer required under this part to maintain records and every person who is in charge or custody of such records shall, upon request of an officer or employee designated by FDA and under section 704(e) of the act, permit such officer or employee at all reasonable times to have access to, and to copy and verify, such records and reports.

[63 FR 42233, Aug. 7, 1998]

#### § 806.40 Public availability of reports.

(a) Any report submitted under this part is available for public disclosure in accordance with part 20 of this chapter.

(b) Before public disclosure of a report, FDA will delete from the report:

(1) Any information that constitutes trade secret or confidential commercial or financial information under § 20.61 of this chapter; and

(2) Any personnel, medical, or similar information, including the serial numbers of implanted devices, which would constitute a clearly unwarranted invasion of personal privacy under § 20.63 of this chapter or 5 U.S.C. 552(b)(6); provided, that except for the information under § 20.61 of this chapter or 5 U.S.C. 552(b)(4), FDA will disclose to a patient who requests a report all the information in the report concerning that patient.

## PART 807—ESTABLISHMENT REGISTRATION AND DEVICE LISTING FOR MANUFACTURERS AND INITIAL IMPORTERS OF DEVICES

### Subpart A—General Provisions

Sec.

807.3 Definitions.

### Subpart B—Procedures for Device Establishments

807.20 Who must register and submit a device list?

807.21 How to register establishments and list devices.

807.22 Times for establishment registration and device listing.

807.25 Information required for device establishment registration and device listing.

807.26 Additional listing information.

807.28 Updating device listing information.

807.34 Summary of requirements for owners or operators granted a waiver from submitting required information electronically.

807.35 Notification of registrant.

807.37 Public availability of establishment registration and device listing information.

807.39 Misbranding by reference to establishment registration or to registration number.

### Subpart C—Procedures for Foreign Device Establishments

807.40 Establishment registration and device listing for foreign establishments importing or offering for import devices into the United States.

807.41 Identification of importers and persons who import or offer for import.

**Subpart D—Exemptions**

807.65 Exemptions for device establishments.

**Subpart E—Premarket Notification Procedures**

807.81 When a premarket notification submission is required.

807.85 Exemption from premarket notification.

807.87 Information required in a premarket notification submission.

807.90 Format of a premarket notification submission.

807.92 Content and format of a 510(k) summary.

807.93 Content and format of a 510(k) statement.

807.94 Format of class III certification.

807.95 Confidentiality of information.

807.97 Misbranding by reference to premarket notification.

807.100 FDA action on a premarket notification.

AUTHORITY: 21 U.S.C. 321, 331, 351, 352, 360, 360c, 360e, 360i, 360j, 360bbb-8b, 371, 374, 379k-1, 381, 393; 42 U.S.C. 264, 271.

SOURCE: 42 FR 42526, Aug. 23, 1977, unless otherwise noted.

**Subpart A—General Provisions****§ 807.3 Definitions.**

(a) *Act* means the Federal Food, Drug, and Cosmetic Act.

(b) *Commercial distribution* means any distribution of a device intended for human use which is held or offered for sale but does not include the following:

(1) Internal or interplant transfer of a device between establishments within the same parent, subsidiary, and/or affiliate company;

(2) Any distribution of a device intended for human use which has in effect an approved exemption for investigational use under section 520(g) of the act and part 812 of this chapter;

(3) Any distribution of a device, before the effective date of part 812 of this chapter, that was not introduced or delivered for introduction into interstate commerce for commercial distribution before May 28, 1976, and that is classified into class III under section 513(f) of the act: *Provided*, That the device is intended solely for investigational use, and under section 501(f)(2)(A) of the act the device is not required to have an approved pre-

market approval application as provided in section 515 of the act; or

(4) For foreign establishments, the distribution of any device that is neither imported nor offered for import into the United States.

(c) *Establishment* means a place of business under one management at one general physical location at which a device is manufactured, assembled, or otherwise processed.

(d) *Manufacture, preparation, propagation, compounding, assembly, or processing* of a device means the making by chemical, physical, biological, or other procedures of any article that meets the definition of device in section 201(h) of the act. These terms include the following activities:

(1) Repackaging or otherwise changing the container, wrapper, or labeling of any device package in furtherance of the distribution of the device from the original place of manufacture to the person who makes final delivery or sale to the ultimate consumer;

(2) Initial importation of devices manufactured in foreign establishments; or

(3) Initiation of specifications for devices that are manufactured by a second party for subsequent commercial distribution by the person initiating specifications.

(e) *Official correspondent* means the person designated by the owner or operator of an establishment as responsible for the following:

(1) The annual registration of the establishment;

(2) Contact with the Food and Drug Administration for device listing;

(3) Maintenance and submission of a current list of officers and directors to the Food and Drug Administration upon the request of the Commissioner; and

(4) The receipt of pertinent correspondence from the Food and Drug Administration directed to and involving the owner or operator and/or any of the firm's establishments.

(f) *Owner or operator* means the corporation, subsidiary, affiliated company, partnership, or proprietor directly responsible for the activities of the registering establishment.

(g) *Initial importer* means any importer who furthers the marketing of a



device from a foreign manufacturer to the person who makes the final delivery or sale of the device to the ultimate consumer or user, but does not repackage, or otherwise change the container, wrapper, or labeling of the device or device package.

(h) Any term defined in section 201 of the act shall have that meaning.

(i) *Restricted device* means a device for which a requirement restricting sale, distribution, or use has been established by a regulation issued under section 520(e) of the act, by order as a condition of premarket approval under section 515(d)(1)(B)(ii) of the act, or by a performance standard issued in accordance with sections 514(a)(2)(B)(v) and 514(b) of the act.

(j) *Classification name* means the term used by the Food and Drug Administration and its classification panels to describe a device or class of devices for purposes of classifying devices under section 513 of the act.

(k) *Product code* means the code used by FDA to identify the generic category of a device.

(l) *Representative sampling of advertisements* means typical advertising material that gives the promotional claims made for the device.

(m) *Representative sampling of any other labeling* means typical labeling material (excluding labels and package inserts) that gives the promotional claims made for the device.

(n) *Material change* includes any change or modification in the labeling or advertisements that affects the identity or safety and effectiveness of the device. These changes may include, but are not limited to, changes in the common or usual or proprietary name, declared ingredients or components, intended use, contraindications, warnings, or instructions for use. Changes that are not material may include graphic layouts, grammar, or correction of typographical errors which do not change the content of the labeling, changes in lot number, and, for devices where the biological activity or known composition differs with each lot produced, the labeling containing the actual values for each lot.

(o) *510(k) summary* (summary of any information respecting safety and effectiveness) means a summary, sub-

mitted under section 513(i) of the act, of the safety and effectiveness information contained in a premarket notification submission upon which a determination of substantial equivalence can be based. Safety and effectiveness information refers to safety and effectiveness data and information supporting a finding of substantial equivalence, including all adverse safety and effectiveness information.

(p) *510(k) statement* means a statement, made under section 513(i) of the act, asserting that all information in a premarket notification submission regarding safety and effectiveness will be made available within 30 days of request by any person if the device described in the premarket notification submission is determined to be substantially equivalent. The information to be made available will be a duplicate of the premarket notification submission, including any adverse safety and effectiveness information, but excluding all patient identifiers, and trade secret or confidential commercial information, as defined in §20.61 of this chapter.

(q) *Class III certification* means a certification that the submitter of the 510(k) has conducted a reasonable search of all known information about the class III device and other similar, legally marketed devices.

(r) *Class III summary* means a summary of the types of safety and effectiveness problems associated with the type of device being compared and a citation to the information upon which the summary is based. The summary must be comprehensive and describe the problems to which the type of device is susceptible and the causes of such problems.

(s) *United States agent* means a person residing or maintaining a place of business in the United States whom a foreign establishment designates as its agent. This definition excludes mailboxes, answering machines or services, or other places where an individual acting as the foreign establishment's agent is not physically present.

(t) *Wholesale distributor* means any person (other than the manufacturer or the initial importer) who distributes a device from the original place of manufacture to the person who makes the

final delivery or sale of the device to the ultimate consumer or user.

(u) *Fiscal year* means the FDA fiscal year, which runs from October 1 through September 30.

(v) *FURLS* means the Food and Drug Administration's Unified Registration and Listing System.

(w) *FDA premarket submission number* means the number assigned by FDA to a premarket device submission, such as a Premarket Approval Application (PMA); Humanitarian Device Exemption (HDE); New Drug Application (NDA); Biologics License Application (BLA); de novo classification petition; or Premarket Notification (510(k)).

(x) *Importer* means, for purposes of this part, a company or individual in the United States that is an owner, consignee, or recipient, even if not the initial owner, consignee, or recipient, of the foreign establishment's device that is imported into the United States. An importer does not include the consumer or patient who ultimately purchases, receives, or uses the device, unless the foreign establishment ships the device directly to the consumer or patient.

(y) *Person who imports or offers for import* means, for purposes of this part, an agent, broker, or other entity, other than a carrier, that the foreign establishment uses to facilitate the import of its device into the United States.

[42 FR 42526, Aug. 23, 1977, as amended at 43 FR 37997, Aug. 25, 1978; 57 FR 18066, Apr. 28, 1992; 58 FR 46522, Sept. 1, 1993; 59 FR 64295, Dec. 14, 1994; 60 FR 63606, Dec. 11, 1995; 63 FR 51826, Sept. 29, 1998; 66 FR 59159, Nov. 27, 2001; 77 FR 45940, Aug. 2, 2012]

### Subpart B—Procedures for Device Establishments

#### § 807.20 Who must register and submit a device list?

(a) An owner or operator of an establishment not exempt under section 510(g) of the Federal Food, Drug, and Cosmetic Act or subpart D of this part who is engaged in the manufacture, preparation, propagation, compounding, assembly, or processing of a device intended for human use shall register and submit listing information for those devices in commercial distribution, except that registration

and listing information may be submitted by the parent, subsidiary, or affiliate company for all the domestic or foreign establishments under the control of one of these organizations when operations are conducted at more than one establishment and there exists joint ownership and control among all the establishments. The term "device" includes all in vitro diagnostic products and in vitro diagnostic biological products not subject to licensing under section 351 of the Public Health Service Act. An owner or operator of an establishment located in any State as defined in section 201(a)(1) of the Federal Food, Drug, and Cosmetic Act shall register its name, places of business, and all establishments and list the devices whether or not the output of the establishments or any particular device so listed enters interstate commerce. The registration and listing requirements shall pertain to any person who is engaged in the manufacture, preparation, propagation, compounding, assembly, or processing of a device intended for human use, including any person who:

(1) Initiates or develops specifications for a device that is to be manufactured by a second party;

(2) Sterilizes or otherwise makes a device for or on behalf of a specifications developer or any other person;

(3) Repackages or relabels a device;

(4) Reprocesses a single use device that has previously been used on a patient;

(5) Acts as an initial importer as defined in §807.3(g), except that initial importers may fulfill their listing obligation for any device for which they did not initiate or develop the specifications for the device or repackage or relabel the device by submitting the name and address of the manufacturer. Initial importers shall also be prepared to submit, when requested by FDA, the proprietary name, if any, and the common or usual name of each device for which they are the initial importer;

(6) Manufactures components or accessories that are ready to be used for any intended health-related purpose

and are packaged or labeled for commercial distribution for such health-related purpose, e.g. blood filters, hemodialysis tubing, or devices which of necessity must be further processed by a licensed practitioner or other qualified person to meet the needs of a particular patient, e.g., a manufacturer of ophthalmic lens blanks.

(b) Registration or listing does not constitute an admission or agreement or determination that a product is a device within the meaning of section 201(h) of the Federal Food, Drug, and Cosmetic Act.

(c) Registration and listing requirements shall not pertain to any person who acts as a wholesale distributor, as defined in §807.3(t), and who does not manufacture, repackage, process, or relabel a device.

(d) Owners and operators of establishments or persons engaged in the recovery, screening, testing, processing, storage, or distribution of human cells, tissues, and cellular and tissue-based products, as defined in §1271.3(d) of this chapter, that are regulated under the Federal Food, Drug, and Cosmetic Act must register and list those human cells, tissues, and cellular and tissue-based products with the Center for Biological Evaluation and Research on Form FDA 3356 following the procedures set out in subpart B of part 1271 of this chapter, instead of the procedures for registration and listing contained in this part, except that the additional listing information requirements of §807.26 remain applicable.

(e) Owners and operators of establishments that manufacture devices licensed under section 351 of the Public Health Service Act as well as licensed biological products used in the manufacture of a licensed device must register and list following the procedures set out in part 607 of this chapter, instead of the procedures for registration and listing contained in this part.

[77 FR 45941, Aug. 2, 2012]

**§ 807.21 How to register establishments and list devices.**

(a) Owners or operators of establishments that are subject to the registration and listing requirements of this part must provide the following information to us using our electronic de-

vice registration and listing system, except as provided in paragraphs (b), (c), and (d) of this section:

(1) Initial establishment registration information as required by §§807.22(a) and 807.25;

(2) Updates to registration information as required by §§807.22(b) and 807.25;

(3) Initial device listing information as required by §§807.22(a), 807.25, and 807.28;

(4) Updates to device listing information as required by §§807.22(b), 807.25, and 807.28, including updates to reflect the discontinuance or resumption of the commercial distribution of a previously-listed device as specified at paragraphs (d) and (e) of §807.28.

(b) If the information under §807.21(a) cannot be submitted electronically, a waiver may be requested. Waivers will be granted only if use of electronic means is not reasonable for the person requesting the waiver. To request a waiver, applicants must send a letter to the Office of Compliance, Center for Devices and Radiological Health, Food and Drug Administration, 10903 New Hampshire Ave., Bldg. 66, rm. 2621, Silver Spring, MD 20993-0002, that includes the following information:

(1) The name and address of the device establishment(s) to be registered, a contact person for the owner or operator of the establishment, and the telephone number at which that person can be reached. If the establishment has already registered in the past, the letter should also include the owner or operator number, registration number, and any listing numbers previously assigned by FDA for devices manufactured at that establishment.

(2) Information about whether the company is an initial importer as defined in §807.3(g) and, if so, whether it also conducts any other activities or operations relating to devices.

(3) A statement that use of the Internet is not reasonable for the person requesting the waiver, and an explanation of why such use is not reasonable. The statement must be signed by the owner or operator of the establishment, or by a person employed by the owner or operator who is authorized to make the declaration on behalf of the owner or operator.

## § 807.22

(c) Those owners or operators who have obtained a waiver from filing registration and listing information electronically should refer to § 807.34 for information on how to submit such information by postal mail.

(d) When additional device listing information (e.g., copies of labeling or advertisements) is requested by FDA as described at § 807.26(e), such information may be submitted by postal mail or electronically by email, but will not be submitted using the FDA electronic device registration and listing system.

[77 FR 45941, Aug. 2, 2012]

### § 807.22 Times for establishment registration and device listing.

(a) *Initial registration and listing.* An owner or operator of an establishment who has not previously entered into an operation described in § 807.20(a) shall register within 30 days after entering into such an operation and submit device listing information at that time.

(b) *Registration and listing updates.* Owners or operators shall review and update all of their establishment registration and device listing information that is on file at FDA, documenting any changes that were not previously reported as follows:

(1) Annual registration for each fiscal year is required for all establishments. Annual registration shall take place during the period beginning on October 1 and ending on December 31 of each fiscal year;

(2) Updates to the registration information as described in § 807.25(b) shall be made within 30 days of any change to such information;

(3) Every fiscal year, during the period beginning on October 1 and ending on December 31, owners or operators shall review and update all of their device listing information that is on file at FDA, reporting any changes or deletions to listings and any new listings that were not previously reported. The accuracy of all information on file must be confirmed each year regardless of whether any changes were made to the owner or operator's list of devices; and

(4) Changes to listing information may also be made at other times, such as when a device is introduced into commercial distribution, when a

## 21 CFR Ch. I (4–1–20 Edition)

change is made to a previously-listed device, or when a previously-listed device is removed from commercial distribution.

(c) *Failure to submit required information.* Failure to submit any of the required information on time, as specified in paragraphs (a) and (b) of this section, will put the establishment in a “failed to register” or “failed to list” status as applicable. The establishment will not be considered active and the establishment registration and device listing information may not appear on the FDA Web site until such time as the owner or operator submits and FDA processes the required information.

[77 FR 45942, Aug. 2, 2012]

### § 807.25 Information required for device establishment registration and device listing.

(a) All owners or operators that are subject to the registration and listing requirements of this part shall provide such information to us by using the FDA electronic device registration and listing system, unless granted a waiver from electronic submission in accordance with § 807.21(b). Electronic submissions of registration and listing information must comply with part 11 of this chapter, except for the requirements in § 11.10(b), (c), and (e), and the corresponding requirements in § 11.30 of this chapter. Those owners or operators granted a waiver from electronic submission should refer to paragraphs (c) and (g) of this section and § 807.34 for instructions on how to submit device registration and listing information.

(b) Registration information required to be submitted includes: The name and mailing address of the device establishment; the Web site address of the device establishment, if any; the name, address, phone number, fax number, and email address of the owner or operator; the name, address, phone number, fax number, and email address of the establishment's official correspondent; and all trade names used by the establishment.

(c) Owners or operators who have been granted a waiver from electronic filing must submit the establishment registration information described in

paragraph (b) of this section, except for the Web site and email address information, in paper form using the procedures set forth in § 807.34.

(d) Each owner or operator is required to maintain a listing of all officers, directors, and partners for each establishment registered by the owner or operator and to furnish this information to FDA upon request.

(e) For each establishment, an official correspondent must be designated by the owner or operator to serve as a point of contact with FDA on matters relating to the registration of device establishments and the listing of device products. Each owner or operator shall also provide FDA with the name of a contact person at the owner or operator's offices who will be responsible for identifying the official correspondent for each establishment. The owner or operator contact person will be the official correspondent in the event no one else has been properly designated. The official correspondent is responsible for:

(1) Providing FDA with all required registration and listing information electronically unless a waiver from electronic submission has been granted in accordance with § 807.21(b);

(2) Receiving all correspondence from FDA concerning registration and listing;

(3) Supplying, when requested by FDA, the names of all officers, directors, and partners; and

(4) Receiving communications from FDA by email, or by postal mail if the owner or operator has been granted a waiver from the requirement to file registration and listing information electronically.

(f) The designation of an official correspondent does not in any manner affect the liability of the owner or operator of the establishment or any other individual under section 301(p) or any other provision of the Federal Food, Drug, and Cosmetic Act.

(g) Device listing information must be submitted to FDA electronically unless a waiver from electronic submission has been granted in accordance with § 807.21(b). Owners or operators who have been granted a waiver must submit the required device listing information, including information re-

quired by this paragraph, § 807.28, and any listing information requested by FDA under § 807.26(e), in paper form using the procedures set forth in § 807.34. The information required for each device listed includes:

(1) The current registration number and name of each establishment under the ownership and control of the owner or operator where the device is manufactured, repackaged, relabeled, or otherwise processed, or where specifications are developed.

(2) The product code for each device that is exempt from premarket notification and approval or which was in commercial distribution prior to May 28, 1976.

(3) The proprietary or brand name(s) under which each device is marketed.

(4) The FDA-assigned premarket submission number of the approved application, cleared premarket notification, granted de novo classification petition, or approved humanitarian device exemption for each device listed that is subject to sections 505, 510(k), 513(f)(2), 515, or 520(m) of the Federal Food, Drug, and Cosmetic Act, which includes devices that are not exempt from premarket notification and approval.

(5) Each activity or process that is conducted on or done to the device at each establishment, such as manufacturing, repacking, relabeling, developing specifications, remanufacturing, single-use device reprocessing, contract manufacturing, contract sterilizing, or manufacturing for export only.

[77 FR 45942, Aug. 2, 2012]

#### § 807.26 Additional listing information.

(a) Each owner or operator shall maintain a historical file containing the labeling and advertisements in use on the date of initial listing, and in use after October 10, 1978, but before the date of initial listing, as follows:

(1) For each device subject to section 514 or 515 of the act that is not a restricted device, a copy of all labeling for the device;

(2) For each restricted device, a copy of all labeling and advertisements for the device;

(3) For each device that is neither restricted nor subject to section 514 or

## § 807.28

## 21 CFR Ch. I (4–1–20 Edition)

515 of the act, a copy of all labels, package inserts, and a representative sampling of any other labeling.

(b) In addition to the requirements set forth in paragraph (a) of this section, each owner or operator shall maintain in the historical file any labeling or advertisements in which a material change has been made anytime after initial listing.

(c) Each owner or operator may discard labeling and advertisements from the historical file 3 years after the date of the last shipment of a discontinued device by an owner or operator.

(d) Location of the file:

(1) Currently existing systems for maintenance of labeling and advertising may be used for the purpose of maintaining the historical file as long as the information included in the systems fulfills the requirements of this section, but only if the labeling and advertisements are retrievable in a timely manner.

(2) The contents of the historical file may be physically located in more than one place in the establishment or in more than one establishment provided there exists joint ownership and control among all the establishments maintaining the historical file. If no joint ownership and control exists, the registered establishment must provide the Food and Drug Administration with a letter authorizing the establishment outside its control to maintain the historical file.

(3) A copy of the certification and disclosure statements as required by part 54 of this chapter shall be retained and physically located at the establishment maintaining the historical file.

(e) Each owner or operator shall be prepared to submit to the Food and Drug Administration, only upon specific request, the following information:

(1) For a device subject to section 514 or 515 of the act that is not a restricted device, a copy of all labeling for the device.

(2) For a device that is a restricted device, a copy of all labeling for the device, a representative sampling of advertisements for the device, and for good cause, a copy of all advertisements for a particular device. A request for all advertisements will, where

feasible, be accompanied by an explanation of the basis for such request.

(3) For a device that is neither a restricted device, nor subject to section 514 or 515 of the act, the label and package insert for the device and a representative sampling of any other labeling for the device.

(4) For a particular device, a statement of the basis upon which the registrant has determined that the device is not subject to section 514 or 515 of the act.

(5) For a particular device, a statement of the basis upon which the registrant has determined the device is not a restricted device.

(6) For a particular device, a statement of the basis for determining that the product is a device rather than a drug.

(7) For a device that the owner or operator has manufactured for distribution under a label other than its own, the names of all distributors for whom it has been manufactured.

(f) Labeling, advertisements, and other information to be submitted upon request in accordance with paragraph (e) of this section may be submitted by postal mail or electronically by email, but will not be submitted using the FDA electronic device registration and listing system. Electronic submissions of such information must comply with part 11 of this chapter, except for the requirements in §11.10 (a), (c) through (h), and (k), and the corresponding requirements in §11.30 of this chapter. The information provided in electronic format must be in a form that we can process, review, and archive.

[43 FR 37999, Aug. 25, 1978, as amended at 51 FR 33033, Sept. 18, 1986; 63 FR 5253, Feb. 2, 1998. Redesignated and amended at 77 FR 45943, Aug. 2, 2012]

### § 807.28 Updating device listing information.

(a) Updating of device listing information is required if an additional establishment begins to engage in any of the activities described in §807.3(d) with respect to a listed device, such as manufacturing, developing specifications, repackaging, relabeling, or otherwise processing the device. Updating

of the listing is also required if an establishment begins performing another activity on or to the device, or ceases to perform an activity on or to the device that had previously been identified on the device listing.

(b) An owner or operator shall create a new device listing using the FDA electronic device registration and listing system:

(1) If introducing into commercial distribution an exempt device identified with a product code that is not currently listed by the owner or operator; or

(2) If introducing into commercial distribution a non-exempt device with an FDA premarket submission number that is not currently listed by the owner or operator.

(c) All device listings for foreign establishments must be submitted before the device may be imported or offered for import into the United States.

(d) An owner or operator who discontinues commercial distribution of a device shall discontinue the device listing using the FDA electronic device registration and listing system. A device listing is considered discontinued if:

(1) All devices under an exempt product code have been discontinued or

(2) All devices associated with an FDA premarket submission number have been discontinued.

(e) If commercial distribution of a discontinued device is resumed, the owner or operator must reactivate the previously-discontinued listing using the electronic device registration and listing system. Any changes to the listing information for the product that is the subject of the listing such as a new establishment, new activity, or new proprietary name must be made using the electronic device registration and listing system at the time the listing is reactivated.

(f) FDA will assign one listing number for all devices exempt from premarket notification requirements under a single product code. For products not exempt from premarket notification requirements, a single listing number will be assigned by FDA for each FDA premarket submission number.

[77 FR 45943, Aug. 2, 2012]

**§ 807.34 Summary of requirements for owners or operators granted a waiver from submitting required information electronically.**

(a) For initial registration and listing, owners or operators who have been granted a waiver from electronic filing using the procedures set forth in § 807.21(b) must send a letter containing all of the registration and listing information described in §§ 807.22, 807.25, (and § 807.26 when such information is requested by FDA), at the times described in § 807.22, to: The Office of Compliance, Center for Devices and Radiological Health, Food and Drug Administration, 10903 New Hampshire Ave., Bldg. 66, rm. 3521, Silver Spring, MD 20993-0002.

(b) As specified in § 807.22(b)(1) and (b)(3), all owners or operators shall update their establishment registration and device listings annually during the period beginning on October 1 and ending on December 31 of each fiscal year.

(c) Failure to submit any of the required information on time, as specified in § 807.22(a) and (b), will put the establishment in a “failed to register” or “failed to list” status as applicable.

The establishment will not be considered active and the establishment registration and device listing information may not appear on the FDA Web site until the required information is submitted to and processed by FDA.

[77 FR 45943, Aug. 2, 2012]

**§ 807.35 Notification of registrant.**

(a) The Food and Drug Administration will assign each device establishment a registration number after verifying the initial establishment registration information that has been submitted. The owner or operator of the establishment will also be assigned an identifying number. Both numbers will be sent to the official correspondent by email, or by postal mail if the owner or operator has been granted a waiver from the requirement to file registration and listing information electronically.

(b) Owners or operators of device establishments who also manufacture or process biological products (including devices licensed under section 351 of the Public Health Service Act) or drug products at the same establishment

## § 807.37

must also register and list those products under part 607 or part 207 of this chapter, as appropriate. Registration and listing for human blood and blood products, devices licensed under section 351 of the Public Health Service Act, and licensed biological products used in the manufacture of a device licensed under section 351 of the Public Health Service Act, are subject to part 607 of this chapter; registration and listing for all other drug products (including other biological products that are also regulated as drug products) are subject to part 207 of this chapter.

(c) Although establishment registration and device listing are required to engage in the device activities described in § 807.20, validation of registration and the assignment of a device listing number in itself does not establish that the holder of the registration is legally qualified to deal in such devices and does not represent a determination by the Food and Drug Administration as to the status of any device.

[69 FR 11312, Mar. 10, 2004, as amended at 77 FR 45943, Aug. 2, 2012]

### **§ 807.37 Public availability of establishment registration and device listing information.**

(a) Establishment registration and device listing information is available for public inspection in accordance with section 510(f) of the Federal Food, Drug, and Cosmetic Act and will be posted on the FDA Web site, with the exception of the information identified in paragraph (b) of this section. Requests for information by persons who do not have access to the Internet should be directed to the Office of Compliance, Center for Devices and Radiological Health, Food and Drug Administration, 10903 New Hampshire Ave., Bldg. 66, rm. 3521, Silver Spring, MD 20993-0002. In addition, there will be available for inspection at each of the Food and Drug Administration district offices the same information for firms within the geographical area of such district offices. Upon request, verification of a registration number or location of a registered establishment will be provided.

## 21 CFR Ch. I (4-1-20 Edition)

(b) The following listing information will not be available for public inspection or posted on the FDA Web site:

(1) For contract manufacturers, contract sterilizers, and private label manufacturers, the proprietary or brand name(s) under which a device is marketed and the FDA-assigned premarket submission number, if this information would reveal a confidential business relationship;

(2) FDA-assigned listing numbers.

[77 FR 45943, Aug. 2, 2012]

### **§ 807.39 Misbranding by reference to establishment registration or to registration number.**

Registration of a device establishment or assignment of a registration number does not in any way denote approval of the establishment or its products. Any representation that creates an impression of official approval because of registration or possession of a registration number is misleading and constitutes misbranding.

## **Subpart C—Procedures for Foreign Device Establishments**

### **§ 807.40 Establishment registration and device listing for foreign establishments importing or offering for import devices into the United States.**

(a) Any establishment within any foreign country engaged in the manufacture, preparation, propagation, compounding, or processing of a device that is imported or offered for import into the United States shall register such establishment and list such devices using the FDA electronic device registration and listing system in conformance with the procedures in this section, § 807.41, and subpart B of this part. The official correspondent for the foreign establishment shall facilitate communication between the foreign establishment's management and representatives of FDA for matters relating to the registration of device establishments and the listing of device products.

(b) Each foreign establishment required to register under paragraph (a) of this section shall submit the name, address, and phone number of its



United States agent as part of its initial and updated registration information in accordance with subpart B of this part. Each foreign establishment shall designate only one United States agent and may designate the United States agent to act as its official correspondent.

(1) The United States agent shall reside or maintain a place of business in the United States.

(2) Upon request from FDA, the United States agent shall assist FDA in communications with the foreign establishment, respond to questions concerning the foreign establishment's products that are imported or offered for import into the United States, and assist FDA in scheduling inspections of the foreign establishment. If the agency is unable to contact the foreign establishment directly or expeditiously, FDA may provide information or documents to the United States agent, and such an action shall be considered to be equivalent to providing the same information or documents to the foreign establishment.

(3) The foreign establishment or the United States agent shall report changes in the United States agent's name, address, or phone number to FDA within 10-business days of the change.

(c) No device may be imported or offered for import into the United States unless it is the subject of a device listing as required under subpart B of this part and is manufactured, prepared, propagated, compounded, or processed at a registered foreign establishment; however, this restriction does not apply to devices imported or offered for import under the investigational use provisions of part 812 of this chapter.

(d) The device establishment registration and device listing information shall be in the English language.

[66 FR 59160, Nov. 27, 2001, as amended at 77 FR 45944, Aug. 2, 2012]

**§807.41 Identification of importers and persons who import or offer for import.**

(a) Upon initial registration, annually, and at the time of any changes, each foreign establishment required to register and list as provided in §807.40(a) must, using the FDA elec-

tronic device registration and listing system, submit the name, address, telephone and fax numbers, email address, and registration number, if any has been assigned, of any importer (defined in §807.3(x)) of the establishment's devices that is known to the foreign establishment. The foreign establishment must also specify which of the establishment's listed products each importer receives from the foreign establishment.

(b) Upon initial registration, annually, and at the time of any changes, each foreign establishment required to register and list as provided in §807.40(a) must, using the FDA electronic device registration and listing system, submit the name, address, telephone and fax numbers, email address, and registration number, if any has been assigned, of each person who imports or offers for import the establishment's devices into the United States. The term "person who imports or offers for import," which is defined in §807.3(y), includes agents, brokers, or other parties used by the foreign establishment to facilitate the import of its device into the United States.

(c) For each individual or organization identified by the foreign establishment under paragraphs (a) and (b) of this section, the foreign establishment must submit to FDA electronically the current FDA premarket submission number and any other identifying information that is known to the establishment for each device being imported or offered for import by the named individuals or organizations.

[77 FR 45944, Aug. 2, 2012]

**Subpart D—Exemptions**

**§807.65 Exemptions for device establishments.**

The following classes of persons are exempt from registration in accordance with §807.20 under the provisions of section 510(g)(1), (g)(2), and (g)(3) of the act, or because the Commissioner of Food and Drugs has found, under section 510(g)(5) of the act, that such registration is not necessary for the protection of the public health. The exemptions in paragraphs (d), (e), (f), and (i) of this section are limited to those classes of persons located in any State

## § 807.81

## 21 CFR Ch. I (4–1–20 Edition)

as defined in section 201(a)(1) of the act.

(a) A manufacturer of raw materials or components to be used in the manufacture or assembly of a device who would otherwise not be required to register under the provisions of this part.

(b) A manufacturer of devices to be used solely for veterinary purposes.

(c) A manufacturer of general purpose articles such as chemical reagents or laboratory equipment whose uses are generally known by persons trained in their use and which are not labeled or promoted for medical uses.

(d) Licensed practitioners, including physicians, dentists, and optometrists, who manufacture or otherwise alter devices solely for use in their practice.

(e) Pharmacies, surgical supply outlets, or other similar retail establishments making final delivery or sale to the ultimate user. This exemption also applies to a pharmacy or other similar retail establishment that purchases a device for subsequent distribution under its own name, e.g., a properly labeled health aid such as an elastic bandage or crutch, indicating “distributed by” or “manufactured for” followed by the name of the pharmacy.

(f) Persons who manufacture, prepare, propagate, compound, or process devices solely for use in research, teaching, or analysis and do not introduce such devices into commercial distribution.

(g) [Reserved]

(h) Carriers by reason of their receipt, carriage, holding or delivery of devices in the usual course of business as carriers.

(i) Persons who dispense devices to the ultimate consumer or whose major responsibility is to render a service necessary to provide the consumer (i.e., patient, physician, layman, etc.) with a device or the benefits to be derived from the use of a device; for example, a hearing aid dispenser, optician, clinical laboratory, assembler of diagnostic x-ray systems, and personnel from a hospital, clinic, dental laboratory, orthotic or prosthetic retail facility, whose primary responsibility to the ultimate consumer is to dispense or pro-

vide a service through the use of a previously manufactured device.

[42 FR 42526, Aug. 23, 1977, as amended at 58 FR 46523, Sept. 1, 1993; 61 FR 44615, Aug. 28, 1996; 65 FR 17136, Mar. 31, 2000; 66 FR 59160, Nov. 27, 2001]

### Subpart E—Premarket Notification Procedures

#### § 807.81 When a premarket notification submission is required.

(a) Except as provided in paragraph (b) of this section, each person who is required to register his establishment pursuant to § 807.20 must submit a premarket notification submission to the Food and Drug Administration at least 90 days before he proposes to begin the introduction or delivery for introduction into interstate commerce for commercial distribution of a device intended for human use which meets any of the following criteria:

(1) The device is being introduced into commercial distribution for the first time; that is, the device is not of the same type as, or is not substantially equivalent to, (i) a device in commercial distribution before May 28, 1976, or (ii) a device introduced for commercial distribution after May 28, 1976, that has subsequently been reclassified into class I or II.

(2) The device is being introduced into commercial distribution for the first time by a person required to register, whether or not the device meets the criteria in paragraph (a)(1) of this section.

(3) The device is one that the person currently has in commercial distribution or is reintroducing into commercial distribution, but that is about to be significantly changed or modified in design, components, method of manufacture, or intended use. The following constitute significant changes or modifications that require a premarket notification:

(i) A change or modification in the device that could significantly affect the safety or effectiveness of the device, e.g., a significant change or modification in design, material, chemical composition, energy source, or manufacturing process.

(ii) A major change or modification in the intended use of the device.

(b)(1) A premarket notification under this subpart is not required for a device for which a premarket approval application under section 515 of the act, or for which a petition to reclassify under section 513(f)(2) of the act, is pending before the Food and Drug Administration.

(2) The appropriate FDA Center Director may determine that the submission and grant of a written request for an exception or alternative under § 801.128 or § 809.11 of this chapter satisfies the requirement in paragraph (a)(3) of this section.

(c) In addition to complying with the requirements of this part, owners or operators of device establishments that manufacture radiation-emitting electronic products, as defined in § 1000.3 of this chapter, shall comply with the reporting requirements of part 1002 of this chapter.

[42 FR 42526, Aug. 23, 1977, as amended at 72 FR 73601, Dec. 28, 2007]

**§ 807.85 Exemption from premarket notification.**

(a) A custom device is exempt from premarket notification requirements of this subpart if the device is within the meaning of section 520(b) of the Federal Food, Drug, and Cosmetic Act.

(1) It is intended for use by a patient named in the order of the physician or dentist (or other specially qualified person); or

(2) It is intended solely for use by a physician or dentist (or other specially qualified person) and is not generally available to, or generally used by, other physicians or dentists (or other specially qualified persons).

(b) A distributor who places a device into commercial distribution for the first time under his own name and a repackager who places his own name on a device and does not change any other labeling or otherwise affect the device shall be exempted from the premarket notification requirements of this subpart if:

(1) The device was in commercial distribution before May 28, 1976; or

(2) A premarket notification submission was filed by another person.

[42 FR 42526, Aug. 23, 1977, as amended at 81 FR 70340, Oct. 12, 2016]

**§ 807.87 Information required in a premarket notification submission.**

Each premarket notification submission shall contain the following information:

(a) The device name, including both the trade or proprietary name and the common or usual name or classification name of the device.

(b) The establishment registration number, if applicable, of the owner or operator submitting the premarket notification submission.

(c) The class in which the device has been put under section 513 of the act and, if known, its appropriate panel; or, if the owner or operator determines that the device has not been classified under such section, a statement of that determination and the basis for the person's determination that the device is not so classified.

(d) Action taken by the person required to register to comply with the requirements of the act under section 514 for performance standards.

(e) Proposed labels, labeling, and advertisements sufficient to describe the device, its intended use, and the directions for its use. Where applicable, photographs or engineering drawings should be supplied.

(f) A statement indicating the device is similar to and/or different from other products of comparable type in commercial distribution, accompanied by data to support the statement. This information may include an identification of similar products, materials, design considerations, energy expected to be used or delivered by the device, and a description of the operational principles of the device.

(g) Where a person required to register intends to introduce into commercial distribution a device that has undergone a significant change or modification that could significantly affect the safety or effectiveness of the device, or the device is to be marketed for a new or different indication for use, the premarket notification submission must include appropriate supporting data to show that the manufacturer has considered what consequences and effects the change or modification or new use might have on the safety and effectiveness of the device.

## § 807.87

## 21 CFR Ch. I (4–1–20 Edition)

(h) A 510(k) summary as described in § 807.92 or a 510(k) statement as described in § 807.93.

(i) A financial certification or disclosure statement or both, as required by part 54 of this chapter.

(j) For a submission supported by clinical data:

(1) If the data are from clinical investigations conducted in the United States, a statement that each investigation was conducted in compliance with applicable requirements in the protection of human subjects regulations in part 50 of this chapter, the institutional review boards regulations in part 56 of this chapter, or was not subject to the regulations under § 56.104 or § 56.105, and the investigational device exemptions regulations in part 812 of this chapter, or if the investigation was not conducted in compliance with those regulations, a brief statement of the reason for the noncompliance.

(2) If the data are from clinical investigations conducted outside the United States, the requirements under § 812.28 of this chapter apply. If any such investigation was not conducted in accordance with good clinical practice (GCP) as described in § 812.28(a) of this chapter, include either a waiver request in accordance with § 812.28(c) of the chapter or a brief statement of the reason for not conducting the investigation in accordance with GCP and a description of steps taken to ensure that the data and results are credible and accurate and that the rights, safety, and well-being of subjects have been adequately protected.

(k) For submissions claiming substantial equivalence to a device which has been classified into class III under section 513(b) of the act:

(1) Which was introduced or delivered for introduction into interstate commerce for commercial distribution before December 1, 1990; and

(2) For which no final regulation requiring premarket approval has been issued under section 515(b) of the act, a summary of the types of safety and effectiveness problems associated with the type of devices being compared and a citation to the information upon which the summary is based (class III summary). The 510(k) submitter shall also certify that a reasonable search of

all information known or otherwise available about the class III device and other similar legally marketed devices has been conducted (class III certification), as described in § 807.94. This information does not refer to information that already has been submitted to the Food and Drug Administration (FDA) under section 519 of the act. FDA may require the submission of the adverse safety and effectiveness data described in the class III summary or citation.

(l) A statement that the submitter believes, to the best of his or her knowledge, that all data and information submitted in the premarket notification are truthful and accurate and that no material fact has been omitted.

(m) Any additional information regarding the device requested by the Commissioner that is necessary for the Commissioner to make a finding as to whether or not the device is substantially equivalent to a device in commercial distribution. A request for additional information will advise the owner or operator that there is insufficient information contained in the original premarket notification submission for the Commissioner to make this determination and that the owner or operator may either submit the requested data or a new premarket notification containing the requested information at least 90 days before the owner or operator intends to market the device, or submit a premarket approval application in accordance with section 515 of the act. If the additional information is not submitted within 30 days following the date of the request, the Commissioner will consider the premarket notification to be withdrawn.

(Information collection requirements in this section were approved by the Office of Management and Budget (OMB) and assigned OMB control number 0910-0281)

[42 FR 42526, Aug. 23, 1977, as amended at 57 FR 18066, Apr. 28, 1992; 59 FR 64295, Dec. 14, 1994; 63 FR 5253, Feb. 2, 1998; 83 FR 7385, Feb. 21, 2018]

**§ 807.90 Format of a premarket notification submission.**

Each premarket notification submission pursuant to this part shall be submitted in accordance with this section. Each submission shall:

(a)(1) For devices regulated by the Center for Devices and Radiological Health, be addressed to the current address displayed on the website <https://www.fda.gov/cdrhsubmissionaddress>.

(2) For devices regulated by the Center for Biologics Evaluation and Research, be addressed to the current address displayed on the website <https://www.fda.gov/AboutFDA/CentersOffices/OfficeofMedicalProductsandTobacco/CBER/ucm385240.htm>; or for devices regulated by the Center for Drug Evaluation and Research, be addressed to the Central Document Room, Center for Drug Evaluation and Research, Food and Drug Administration, 5901-B Ammendale Rd., Beltsville, MD 20705-1266. Information about devices regulated by the Center for Biologics Evaluation and Research is available at <https://www.fda.gov/BiologicsBloodVaccines/BloodBloodProducts/ApprovedProducts/default.htm>.

(3) All inquiries regarding a premarket notification submission should be sent to the address in this section or one of the current addresses displayed on the Food and Drug Administration's website.

(b) [Reserved]

(c) Be submitted as a single version in electronic format.

(d) Be submitted separately for each product the manufacturer intends to market.

(e) Designated "510(k) Notification" in the cover letter.

[42 FR 42526, Aug. 23, 1977, as amended at 53 FR 11252, Apr. 6, 1988; 55 FR 11169, Mar. 27, 1990; 65 FR 17137, Mar. 31, 2000; 70 FR 14986, Mar. 24, 2005; 75 FR 20915, Apr. 22, 2010; 80 FR 18094, Apr. 3, 2015; 84 FR 68339, Dec. 16, 2019]

**§ 807.92 Content and format of a 510(k) summary.**

(a) A 510(k) summary shall be in sufficient detail to provide an understanding of the basis for a determination of substantial equivalence. FDA will accept summaries as well as amendments thereto until such time as

FDA issues a determination of substantial equivalence. All 510(k) summaries shall contain the following information:

(1) The submitter's name, address, telephone number, a contact person, and the date the summary was prepared;

(2) The name of the device, including the trade or proprietary name if applicable, the common or usual name, and the classification name, if known;

(3) An identification of the legally marketed device to which the submitter claims equivalence. A legally marketed device to which a new device may be compared for a determination regarding substantial equivalence is a device that was legally marketed prior to May 28, 1976, or a device which has been reclassified from class III to class II or I (the predicate), or a device which has been found to be substantially equivalent through the 510(k) premarket notification process;

(4) A description of the device that is the subject of the premarket notification submission, such as might be found in the labeling or promotional material for the device, including an explanation of how the device functions, the scientific concepts that form the basis for the device, and the significant physical and performance characteristics of the device, such as device design, material used, and physical properties;

(5) A statement of the intended use of the device that is the subject of the premarket notification submission, including a general description of the diseases or conditions that the device will diagnose, treat, prevent, cure, or mitigate, including a description, where appropriate, of the patient population for which the device is intended. If the indication statements are different from those of the legally marketed device identified in paragraph (a)(3) of this section, the 510(k) summary shall contain an explanation as to why the differences are not critical to the intended therapeutic, diagnostic, prosthetic, or surgical use of the device, and why the differences do not affect the safety and effectiveness of the device when used as labeled; and

**§ 807.93**

**21 CFR Ch. I (4–1–20 Edition)**

(6) If the device has the same technological characteristics (i.e., design, material, chemical composition, energy source) as the predicate device identified in paragraph (a)(3) of this section, a summary of the technological characteristics of the new device in comparison to those of the predicate device. If the device has different technological characteristics from the predicate device, a summary of how the technological characteristics of the device compare to a legally marketed device identified in paragraph (a)(3) of this section.

(b) 510(k) summaries for those premarket submissions in which a determination of substantial equivalence is also based on an assessment of performance data shall contain the following information:

(1) A brief discussion of the nonclinical tests submitted, referenced, or relied on in the premarket notification submission for a determination of substantial equivalence;

(2) A brief discussion of the clinical tests submitted, referenced, or relied on in the premarket notification submission for a determination of substantial equivalence. This discussion shall include, where applicable, a description of the subjects upon whom the device was tested, a discussion of the safety or effectiveness data obtained from the testing, with specific reference to adverse effects and complications, and any other information from the clinical testing relevant to a determination of substantial equivalence; and

(3) The conclusions drawn from the nonclinical and clinical tests that demonstrate that the device is as safe, as effective, and performs as well as or better than the legally marketed device identified in paragraph (a)(3) of this section.

(c) The summary should be in a separate section of the submission, beginning on a new page and ending on a page not shared with any other section of the premarket notification submission, and should be clearly identified as a “510(k) summary.”

(d) Any other information reasonably deemed necessary by the agency.

[57 FR 18066, Apr. 28, 1992, as amended at 59 FR 64295, Dec. 14, 1994]

**§ 807.93 Content and format of a 510(k) statement.**

(a)(1) A 510(k) statement submitted as part of a premarket notification shall state as follows:

I certify that, in my capacity as (the position held in company by person required to submit the premarket notification, preferably the official correspondent in the firm), of (company name), I will make available all information included in this premarket notification on safety and effectiveness within 30 days of request by any person if the device described in the premarket notification submission is determined to be substantially equivalent. The information I agree to make available will be a duplicate of the premarket notification submission, including any adverse safety and effectiveness information, but excluding all patient identifiers, and trade secret and confidential commercial information, as defined in 21 CFR 20.61.

(2) The statement in paragraph (a)(1) of this section should be signed by the certifier, made on a separate page of the premarket notification submission, and clearly identified as “510(k) statement.”

(b) All requests for information included in paragraph (a) of this section shall be made in writing to the certifier, whose name will be published by FDA on the list of premarket notification submissions for which substantial equivalence determinations have been made.

(c) The information provided to requestors will be a duplicate of the premarket notification submission, including any adverse information, but excluding all patient identifiers, and trade secret and confidential commercial information as defined in § 20.61 of this chapter.

[59 FR 64295, Dec. 14, 1994]

**§ 807.94 Format of a class III certification.**

(a) A class III certification submitted as part of a premarket notification shall state as follows:

I certify, in my capacity as (position held in company), of (company name), that I have conducted a reasonable search of all information known or otherwise available about the types and causes of safety or effectiveness problems that have been reported for the (type of device). I further certify that I am aware of the types of problems to which

the (type of device) is susceptible and that, to the best of my knowledge, the following summary of the types and causes of safety or effectiveness problems about the (type of device) is complete and accurate.

(b) The statement in paragraph (a) of this section should be signed by the certifier, clearly identified as "class III certification," and included at the beginning of the section of the premarket notification submission that sets forth the class III summary.

[59 FR 64296, Dec. 14, 1994]

**§ 807.95 Confidentiality of information.**

(a) The Food and Drug Administration will disclose publicly whether there exists a premarket notification submission under this part:

(1) Where the device is on the market, i.e., introduced or delivered for introduction into interstate commerce for commercial distribution;

(2) Where the person submitting the premarket notification submission has disclosed, through advertising or any other manner, his intent to market the device to scientists, market analysts, exporters, or other individuals who are not employees of, or paid consultants to, the establishment and who are not in an advertising or law firm pursuant to commercial arrangements with appropriate safeguards for secrecy; or

(3) Where the device is not on the market and the intent to market the device has not been so disclosed, except where the submission is subject to an exception under paragraph (b) or (c) of this section.

(b) The Food and Drug Administration will not disclose publicly the existence of a premarket notification submission for a device that is not on the market and where the intent to market the device has not been disclosed for 90 days from the date of receipt of the submission, if:

(1) The person submitting the premarket notification submission requests in the submission that the Food and Drug Administration hold as confidential commercial information the intent to market the device and submits a certification to the Commissioner:

(i) That the person considers his intent to market the device to be confidential commercial information;

(ii) That neither the person nor, to the best of his knowledge, anyone else, has disclosed through advertising or any other manner, his intent to market the device to scientists, market analysts, exporters, or other individuals, except employees of, or paid consultants to, the establishment or individuals in an advertising or law firm pursuant to commercial arrangements with appropriate safeguards for secrecy;

(iii) That the person will immediately notify the Food and Drug Administration if he discloses the intent to market the device to anyone, except employees of, or paid consultants to, the establishment or individuals in an advertising or law firm pursuant to commercial arrangements with appropriate safeguards for secrecy;

(iv) That the person has taken precautions to protect the confidentiality of the intent to market the device; and

(v) That the person understands that the submission to the government of false information is prohibited by 18 U.S.C. 1001 and 21 U.S.C. 331(q); and

(2) The Commissioner agrees that the intent to market the device is confidential commercial information.

(c) Where the Commissioner determines that the person has complied with the procedures described in paragraph (b) of this section with respect to a device that is not on the market and where the intent to market the device has not been disclosed, and the Commissioner agrees that the intent to market the device is confidential commercial information, the Commissioner will not disclose the existence of the submission for 90 days from the date of its receipt by the agency. In addition, the Commissioner will continue not to disclose the existence of such a submission for the device for an additional time when any of the following occurs:

(1) The Commissioner requests in writing additional information regarding the device pursuant to § 807.87(h), in which case the Commissioner will not disclose the existence of the submission until 90 days after the Food and Drug Administration's receipt of a complete premarket notification submission;

## § 807.97

(2) The Commissioner determines that the device intended to be introduced is a class III device and cannot be marketed without premarket approval or reclassification, in which case the Commissioner will not disclose the existence of the submission unless a petition for reclassification is submitted under section 513(f)(2) of the act and its existence can be disclosed under § 860.5(d) of this chapter; or

(d) FDA will make a 510(k) summary of the safety and effectiveness data available to the public within 30 days of the issuance of a determination that the device is substantially equivalent to another device. Accordingly, even when a 510(k) submitter has complied with the conditions set forth in paragraphs (b) and (c) of this section, confidentiality for a premarket notification submission cannot be granted beyond 30 days after FDA issues a determination of equivalency.

(e) Data or information submitted with, or incorporated by reference in, a premarket notification submission (other than safety and effectiveness data that have not been disclosed to the public) shall be available for disclosure by the Food and Drug Administration when the intent to market the device is no longer confidential in accordance with this section, unless exempt from public disclosure in accordance with part 20 of this chapter. Upon final classification, data and information relating to safety and effectiveness of a device classified in class I (general controls) or class II (performance standards) shall be available for public disclosure. Data and information relating to safety and effectiveness of a device classified in class III (premarket approval) that have not been released to the public shall be retained as confidential unless such data and information become available for release to the public under § 860.5(d) or other provisions of this chapter.

[42 FR 42526, Aug. 23, 1977, as amended at 53 FR 11252, Apr. 6, 1988; 57 FR 18067, Apr. 28, 1992; 59 FR 64296, Dec. 14, 1994; 84 FR 68339, Dec. 16, 2019]

### **§ 807.97 Misbranding by reference to premarket notification.**

Submission of a premarket notification in accordance with this subpart,

## 21 CFR Ch. I (4–1–20 Edition)

and a subsequent determination by the Commissioner that the device intended for introduction into commercial distribution is substantially equivalent to a device in commercial distribution before May 28, 1976, or is substantially equivalent to a device introduced into commercial distribution after May 28, 1976, that has subsequently been reclassified into class I or II, does not in any way denote official approval of the device. Any representation that creates an impression of official approval of a device because of complying with the premarket notification regulations is misleading and constitutes misbranding.

### **§ 807.100 FDA action on a premarket notification.**

(a) After review of a premarket notification, FDA will:

(1) Issue an order declaring the device to be substantially equivalent to a legally marketed predicate device;

(2) Issue an order declaring the device to be not substantially equivalent to any legally marketed predicate device;

(3) Request additional information; or

(4) Withhold the decision until a certification or disclosure statement is submitted to FDA under part 54 of this chapter.

(5) Advise the applicant that the premarket notification is not required. Until the applicant receives an order declaring a device substantially equivalent, the applicant may not proceed to market the device.

(b) FDA will determine that a device is substantially equivalent to a predicate device using the following criteria:

(1) The device has the same intended use as the predicate device; and

(2) The device:

(i) Has the same technological characteristics as the predicate device; or

(ii)(A) Has different technological characteristics, such as a significant change in the materials, design, energy source, or other features of the device from those of the predicate device;

(B) The data submitted establishes that the device is substantially equivalent to the predicate device and contains information, including clinical



data if deemed necessary by the Commissioner, that demonstrates that the device is as safe and as effective as a legally marketed device; and

(C) Does not raise different questions of safety and effectiveness than the predicate device.

(3) The predicate device has not been removed from the market at the initiative of the Commissioner of Food and Drugs or has not been determined to be misbranded or adulterated by a judicial order.

[57 FR 58403, Dec. 10, 1992, as amended at 63 FR 5253, Feb. 2, 1998]

## **PART 808—EXEMPTIONS FROM FEDERAL PREEMPTION OF STATE AND LOCAL MEDICAL DEVICE REQUIREMENTS**

### **Subpart A—General Provisions**

Sec.

808.1 Scope.

808.3 Definitions.

808.5 Advisory opinions.

### **Subpart B—Exemption Procedures**

808.20 Application.

808.25 Procedures for processing an application.

808.35 Revocation of an exemption.

### **Subpart C—Listing of Specific State and Local Exemptions**

808.53 Arizona.

808.55 California.

808.57 Connecticut.

808.59 Florida.

808.61 Hawaii.

808.67 Kentucky.

808.69 Maine.

808.71 Massachusetts.

808.73 Minnesota.

808.74 Mississippi.

808.77 Nebraska.

808.80 New Jersey.

808.81 New Mexico.

808.82 New York.

808.85 Ohio.

808.87 Oregon.

808.88 Pennsylvania.

808.89 Rhode Island.

808.93 Texas.

808.97 Washington.

808.98 West Virginia.

808.101 District of Columbia.

AUTHORITY: 21 U.S.C. 360j, 360k, 371.

SOURCE: 43 FR 18665, May 2, 1978, unless otherwise noted.

## **Subpart A—General Provisions**

### **§ 808.1 Scope.**

(a) This part prescribes procedures for the submission, review, and approval of applications for exemption from Federal preemption of State and local requirements applicable to medical devices under section 521 of the act.

(b) Section 521(a) of the act contains special provisions governing the regulation of devices by States and localities. That section prescribes a general rule that after May 28, 1976, no State or political subdivision of a State may establish or continue in effect any requirement with respect to a medical device intended for human use having the force and effect of law (whether established by statute, ordinance, regulation, or court decision), which is different from, or in addition to, any requirement applicable to such device under any provision of the act and which relates to the safety or effectiveness of the device or to any other matter included in a requirement applicable to the device under the act.

(c) Section 521(b) of the act contains a provision whereby the Commissioner of Food and Drugs may, upon application by a State or political subdivision, allow imposition of a requirement which is different from, or in addition to, any requirement applicable under the act to the device (and which is thereby preempted) by promulgating a regulation in accordance with this part exempting the State or local requirement from preemption. The granting of an exemption does not affect the applicability to the device of any requirements under the act. The Commissioner may promulgate an exemption regulation for the preempted requirement if he makes either of the following findings:

(1) That the requirement is more stringent than a requirement under the act applicable to the device; or

(2) That the requirement is required by compelling local conditions and compliance with the requirement would not cause the device to be in violation of any applicable requirement under the act.

(d) State or local requirements are preempted only when the Food and

Drug Administration has established specific counterpart regulations or there are other specific requirements applicable to a particular device under the act, thereby making any existing divergent State or local requirements applicable to the device different from, or in addition to, the specific Food and Drug Administration requirements. There are other State or local requirements that affect devices that are not preempted by section 521(a) of the act because they are not “requirements applicable to a device” within the meaning of section 521(a) of the act. The following are examples of State or local requirements that are not regarded as preempted by section 521 of the act:

(1) Section 521(a) does not preempt State or local requirements of general applicability where the purpose of the requirement relates either to other products in addition to devices (e.g., requirements such as general electrical codes, and the Uniform Commercial Code (warranty of fitness)), or to unfair trade practices in which the requirements are not limited to devices.

(2) Section 521(a) does not preempt State or local requirements that are equal to, or substantially identical to, requirements imposed by or under the act.

(3) Section 521(a) does not preempt State or local permits, licensing, registration, certification, or other requirements relating to the approval or sanction of the practice of medicine, dentistry, optometry, pharmacy, nursing, podiatry, or any other of the healing arts or allied medical sciences or related professions or occupations that administer, dispense, or sell devices. However, regulations issued under section 520(e) or (g) of the act may impose restrictions on the sale, distribution, or use of a device beyond those prescribed in State or local requirements. If there is a conflict between such restrictions and State or local requirements, the Federal regulations shall prevail.

(4) Section 521(a) does not preempt specifications in contracts entered into by States or localities for procurement of devices.

(5) Section 521(a) does not preempt criteria for payment of State or local obligations under Medicaid and similar

Federal, State or local health-care programs.

(6)(i) Section 521(a) does not preempt State or local requirements respecting general enforcement, e.g., requirements that State inspection be permitted of factory records concerning all devices, registration, and licensing requirements for manufacturers and others, and prohibition of manufacture of devices in unlicensed establishments. However, Federal regulations issued under sections 519 and 520(f) of the act may impose requirements for records and reports and good manufacturing practices beyond those prescribed in State or local requirements. If there is a conflict between such regulations and State or local requirements, the Federal regulations shall prevail.

(ii) Generally, section 521(a) does not preempt a State or local requirement prohibiting the manufacture of adulterated or misbranded devices. Where, however, such a prohibition has the effect of establishing a substantive requirement for a specific device, e.g., a specific labeling requirement, then the prohibition will be preempted if the requirement is different from, or in addition to, a Federal requirement established under the act. In determining whether such a requirement is preempted, the determinative factor is how the requirement is interpreted and enforced by the State or local government and not the literal language of the statute, which may be identical to a provision in the act.

(7) Section 521(a) does not preempt State or local provisions respecting delegations of authority and related administrative matters relating to devices.

(8) Section 521(a) does not preempt a State or local requirement whose sole purpose is raising revenue or charging fees for services, registration, or regulatory programs.

(9) Section 521(a) does not preempt State or local requirements of the types that have been developed under the Atomic Energy Act of 1954 (42 U.S.C. 2011 note), as amended, Subchapter C—Electronic Product Radiation Control of the Federal Food, Drug, and Cosmetic Act (formerly the

Radiation Control for Health and Safety Act of 1968), and other Federal statutes, until such time as the Food and Drug Administration issues specific requirements under the Federal Food, Drug, and Cosmetic Act applicable to these types of devices.

(10) Part 820 of this chapter (21 CFR part 820) (CGMP requirements) does not preempt remedies created by States or Territories of the United States, the District of Columbia, or the Commonwealth of Puerto Rico.

(e) It is the responsibility of the Food and Drug Administration, subject to review by Federal courts, to determine whether a State or local requirement is equal to, or substantially identical to, requirements imposed by or under the act, or is different from, or in addition to, such requirements, in accordance with the procedures provided by this part. However, it is the responsibility of States and political subdivisions to determine initially whether to seek exemptions from preemption. Any State or political subdivision whose requirements relating to devices are preempted by section 521(a) may petition the Commissioner of Food and Drugs for exemption from preemption, in accordance with the procedures provided by this part.

(f) The Federal requirement with respect to a device applies whether or not a corresponding State or local requirement is preempted or exempted from preemption. As a result, if a State or local requirement that the Food and Drug Administration has exempted from preemption is not as broad in its application as the Federal requirement, the Federal requirement applies to all circumstances not covered by the State or local requirement.

[43 FR 18665, May 2, 1978, as amended at 45 FR 67336, Oct. 10, 1980; 61 FR 52654, Oct. 7, 1996; 73 FR 34859, June 19, 2008]

### § 808.3 Definitions.

(a) *Act* means the Federal Food, Drug, and Cosmetic Act.

(b) *Compelling local conditions* includes any factors, considerations, or circumstances prevailing in, or characteristic of, the geographic area or population of the State or political subdivision that justify exemption from preemption.

(c) *More stringent* refers to a requirement of greater restrictiveness or one that is expected to afford to those who may be exposed to a risk of injury from a device a higher degree of protection than is afforded by a requirement applicable to the device under the act.

(d) *Political subdivision* or *locality* means any lawfully established local governmental unit within a State which unit has the authority to establish or continue in effect any requirement having the force and effect of law with respect to a device intended for human use.

(e) *State* means a State, American Samoa, the Canal Zone, the Commonwealth of Puerto Rico, the District of Columbia, Guam, Johnston Island, Kingman Reef, Midway Island, the Trust Territory of the Pacific Islands, the Virgin Islands, and Wake Island.

(f) *Substantially identical to* refers to the fact that a State or local requirement does not significantly differ in effect from a Federal requirement.

### § 808.5 Advisory opinions.

(a) Any State, political subdivision, or other interested person may request an advisory opinion from the Commissioner with respect to any general matter concerning preemption of State or local device requirements or with respect to whether the Food and Drug Administration regards particular State or local requirements, or proposed requirements, as preempted.

(1) Such an advisory opinion may be requested and may be granted in accordance with § 10.85 of this chapter.

(2) The Food and Drug Administration, in its discretion and after consultation with the State or political subdivision, may treat a request by a State or political subdivision for an advisory opinion as an application for exemption from preemption under § 808.20.

(b) The Commissioner may issue an advisory opinion relating to a State or local requirement on his own initiative when he makes one of the following determinations:

(1) A requirement with respect to a device for which an application for exemption from preemption has been submitted under § 808.20 is not preempted by section 521(a) of the act because it

**§ 808.20**

**21 CFR Ch. I (4-1-20 Edition)**

is: (i) Equal to or substantially identical to a requirement under the act applicable to the device, or (ii) is not a requirement within the meaning of section 521 of the act and therefore is not preempted;

(2) A proposed State or local requirement with respect to a device is not eligible for exemption from preemption because the State or local requirement has not been issued in final form. In such a case, the advisory opinion may indicate whether the proposed requirement would be preempted and, if it would be preempted, whether the Food and Drug Administration would propose to grant an exemption from preemption;

(3) Issuance of such an advisory opinion is in the public interest.

**Subpart B—Exemption Procedures**

**§ 808.20 Application.**

(a) Any State or political subdivision may apply to the Food and Drug Administration for an exemption from preemption for any requirement that it has enacted and that is preempted. An exemption may only be granted for a requirement that has been enacted, promulgated, or issued in final form by the authorized body or official of the State or political subdivision so as to have the force and effect of law. However, an application for exemption may be submitted before the effective date of the requirement.

(b) An application for exemption shall be in the form of a letter to the Commissioner of Food and Drugs and shall be signed by an individual who is authorized to request the exemption on behalf of the State or political subdivision. An original and two copies of the letter and any accompanying material, as well as any subsequent reports or correspondence concerning an application, shall be submitted to the Division of Dockets Management (HFA-305), Food and Drug Administration, 5630 Fishers Lane, rm. 1061, Rockville, MD 20852. The outside wrapper of any application, report, or correspondence should indicate that it concerns an application for exemption from preemption of device requirements.

(c) For each requirement for which an exemption is sought, the application

shall include the following information to the fullest extent possible, or an explanation of why such information has not been included:

(1) Identification and a current copy of any statute, rule, regulation, or ordinance of the State or political subdivision considered by the State or political subdivision to be a requirement which is preempted, with a reference to the date of enactment, promulgation, or issuance in final form. The application shall also include, where available, copies of any legislative history or background materials pertinent to enactment, promulgation, or issuance of the requirement, including hearing reports or studies concerning development or consideration of the requirement. If the requirement has been subject to any judicial or administrative interpretations, the State or political subdivision shall furnish copies of such judicial or administrative interpretations.

(2) A comparison of the requirement of the State or political subdivision and any applicable Federal requirements to show similarities and differences.

(3) Information on the nature of the problem addressed by the requirement of the State or political subdivision.

(4) Identification of which (or both) of the following bases is relied upon for seeking an exemption from preemption:

(i) The requirement is more stringent than a requirement applicable to a device under the act. If the State or political subdivision relies upon this basis for exemption from preemption, the application shall include information, data, or material showing how and why the requirement of the State or political subdivision is more stringent than requirements under the act.

(ii) The requirement is required by compelling local conditions, and compliance with the requirement would not cause the device to be in violation of any applicable requirement under the act. If the State or political subdivision relies upon this basis for exemption from preemption, the application shall include information, data, or material showing why compliance with

## Food and Drug Administration, HHS

## § 808.25

the requirement of the State or political subdivision would not cause a device to be in violation of any applicable requirement under the act and why the requirement is required by compelling local conditions. The application shall also explain in detail the compelling local conditions that justify the requirement.

(5) The title of the chief administrative or legal officers of that State or local agency that has primary responsibility for administration of the requirement.

(6) When requested by the Food and Drug Administration, any records concerning administration of any requirement which is the subject of an exemption or an application for an exemption from preemption.

(7) Information on how the public health may be benefitted and how interstate commerce may be affected, if an exemption is granted.

(8) Any other pertinent information respecting the requirement voluntarily submitted by the applicant.

(d) If litigation regarding applicability of the requirement is pending, the State or political subdivision may so indicate in its application and request expedited action on such application.

[43 FR 18665, May 2, 1978; 43 FR 22010, May 23, 1978, as amended at 49 FR 3646, Jan. 30, 1984; 59 FR 14365, Mar. 28, 1994]

### **§ 808.25 Procedures for processing an application.**

(a) Upon receipt of an application for an exemption from preemption submitted in accordance with § 808.20, the Commissioner shall notify the State or political subdivision of the date of such receipt.

(b) If the Commissioner finds that an application does not meet the requirements of § 808.20, he shall notify the State or political subdivision of the deficiencies in the application and of the opportunity to correct such deficiencies. A deficient application may be corrected at any time.

(c) After receipt of an application meeting the requirements of § 808.20, the Commissioner shall review such application and determine whether to grant or deny an exemption from preemption for each requirement which is

the subject of the application. The Commissioner shall then issue in the FEDERAL REGISTER a proposed regulation either to grant or to deny an exemption from preemption. The Commissioner shall also issue in the FEDERAL REGISTER a notice of opportunity to request an oral hearing before the Commissioner or the Commissioner's designee.

(d) A request for an oral hearing may be made by the State or political subdivision or any other interested person. Such request shall be submitted to the Division of Dockets Management within the period of time prescribed in the notice and shall include an explanation of why an oral hearing, rather than submission of written comments only, is essential to the presentation of views on the application for exemption from preemption and the proposed regulation.

(e) If a timely request for an oral hearing is made, the Commissioner shall review such a request and may grant a legislative-type informal oral hearing pursuant to part 15 of this chapter by publishing in the FEDERAL REGISTER a notice of the hearing in accordance with § 15.20 of this chapter. The scope of the oral hearing shall be limited to matters relevant to the application for exemption from preemption and the proposed regulation. Oral or written presentations at the oral hearing which are not relevant to the application shall be excluded from the administrative record of the hearing.

(f) If a request for hearing is not timely made or a notice of appearance is not filed pursuant to § 15.21 of this chapter, the Commissioner shall consider all written comments submitted and publish a final rule in accordance with paragraph (g) of this section.

(g)(1) The Commissioner shall review all written comments submitted on the proposed rule and the administrative record of the oral hearing, if an oral hearing has been granted, and shall publish in the FEDERAL REGISTER a final rule in subpart C of this part identifying any requirement in the application for which exemption from preemption is granted, or conditionally granted, and any requirement in the application for which exemption from preemption is not granted.

## § 808.35

(2) The Commissioner may issue a regulation granting or conditionally granting an application for an exemption from preemption for any requirement if the Commissioner makes either of the following findings:

(i) The requirement is more stringent than a requirement applicable to the device under the act;

(ii) The requirement is required by compelling local conditions, and compliance with the requirement would not cause the device to be in violation of any requirement applicable to the device under the act.

(3) The Commissioner may not grant an application for an exemption from preemption for any requirement with respect to a device if the Commissioner determines that the granting of an exemption would not be in the best interest of public health, taking into account the potential burden on interstate commerce.

(h) An advisory opinion pursuant to § 808.5 or a regulation pursuant to paragraph (g) of this section constitutes final agency action.

### § 808.35 Revocation of an exemption.

(a) An exemption from preemption pursuant to a regulation under this part shall remain effective until the Commissioner revokes such exemption.

(b) The Commissioner may by regulation, in accordance with § 808.25, revoke an exemption from preemption for any of the following reasons:

(1) An exemption may be revoked upon the effective date of a newly established requirement under the act which, in the Commissioner's view, addresses the objectives of an exempt requirement and which is described, when issued, as preempting a previously exempt State or local requirement.

(2) An exemption may be revoked upon a finding that there has occurred a change in the bases listed in § 808.20(c)(4) upon which the exemption was granted.

(3) An exemption may be revoked if it is determined that a condition placed on the exemption by the regulation under which the exemption was granted has not been met or is no longer being met.

## 21 CFR Ch. I (4-1-20 Edition)

(4) An exemption may be revoked if a State or local jurisdiction fails to submit records as provided in § 808.20(c)(6).

(5) An exemption may be revoked if a State or local jurisdiction to whom the exemption was originally granted requests revocation.

(6) An exemption may be revoked if it is determined that it is no longer in the best interests of the public health to continue the exemption.

(c) An exemption that has been revoked may be reinstated, upon request from the State or political subdivision, if the Commissioner, in accordance with the procedures in § 808.25, determines that the grounds for revocation are no longer applicable except that the Commissioner may permit abbreviated submissions of the documents and materials normally required for an application for exemption under § 808.20.

### Subpart C—Listing of Specific State and Local Exemptions

#### § 808.53 Arizona.

The following Arizona medical device requirements are preempted by section 521(a) of the act, and the Food and Drug Administration has denied them exemptions from preemption under section 521(b) of the act:

(a) Arizona Revised Statutes, Chapter 17, sections 36-1901.7(s) and 36-1901.7(t).

(b) Arizona Code of Revised Regulations, Title 9, Article 3, sections R9-16-303 and R9-16-304.

[45 FR 67336, Oct. 10, 1980]

#### § 808.55 California.

(a) The following California medical device requirements are enforceable notwithstanding section 521 of the act because the Food and Drug Administration exempted them from preemption under section 521(b) of the act: Business and Professions Code sections 3365 and 3365.6.

(b) The following California medical device requirements are preempted by section 521 of the act, and FDA has denied them an exemption from preemption:

## Food and Drug Administration, HHS

## § 808.71

(1) Sherman Food, Drug, and Cosmetic Law (Division 21 of the California Health and Safety Code), sections 26207, 26607, 26614, 26615, 26618, 26631, 26640, and 26641, to the extent that they apply to devices.

(2) Sherman Food, Drug, and Cosmetic Law, section 26463(m) to the extent that it applies to hearing aids.

(3) Business and Professions Code section 2541.3, to the extent that it requires adoption of American National Standards Institute standards Z-80.1 and Z-80.2.

[45 FR 67324, Oct. 10, 1980]

### § 808.57 Connecticut.

The following Connecticut medical device requirements are enforceable notwithstanding section 521(a) of the act because the Food and Drug Administration has exempted them from preemption under section 521(b) of the act: Connecticut General Statutes, sections 20-403 and 20-404.

[45 FR 67336, Oct. 10, 1980]

### § 808.59 Florida.

The following Florida medical device requirements are preempted by section 521(a) of the act, and the Food and Drug Administration has denied them an exemption from preemption under section 521(b) of the act:

(a) Florida Statutes, section 468.135(5).

(b) Florida Administrative Code, section 10D-48.25(26).

[45 FR 67336, Oct. 10, 1980]

### § 808.61 Hawaii.

(a) The following Hawaii medical device requirements are enforceable notwithstanding section 521 of the act, because the Food and Drug Administration has exempted them from preemption under section 521(b) of the act: Hawaii Revised Statutes, chapter 451A, §14.1, subsection (a) with respect to medical examination of a child 10 years of age or under, and subsection (c).

(b) The following Hawaii medical device requirements are preempted by section 521(a) of the act, and the Food and Drug Administration has denied them exemption from preemption: Hawaii Revised Statutes, chapter 451A, §14.1, subsection (a) to the extent that

it requires a written authorization by a physician and does not allow adults to waive this requirement for personal, as well as religious reasons, and subsection (b).

[50 FR 30699, July 29, 1985; 50 FR 32694, Aug. 14, 1985]

### § 808.67 Kentucky.

The following Kentucky medical device requirement is preempted by section 521(a) of the act, and the Food and Drug Administration has denied it an exemption from preemption under section 521(b) of the act: Kentucky Revised Statutes, section 334.200(1).

[45 FR 67336, Oct. 10, 1980]

### § 808.69 Maine.

(a) The following Maine medical device requirement is enforceable notwithstanding section 521(a) of the act because the Food and Drug Administration has exempted it from preemption under section 521(b) of the act: Maine Revised Statutes Annotated, Title 32, section 1658-C, on the condition that, in enforcing this requirement, Maine apply the definition of "used hearing aid" in §801.420(a)(6) of this chapter.

(b) The following Maine medical device requirement is preempted by section 521(a) of the act, and the Food and Drug Administration has denied it an exemption from preemption under section 521(b) of the act: Maine Revised Statutes Annotated, Title 32, section 1658-D and the last sentence of section 1658-E.

[45 FR 67336, Oct. 10, 1980]

### § 808.71 Massachusetts.

(a) The following Massachusetts medical device requirements are enforceable notwithstanding section 521 of the act because the Food and Drug Administration has exempted them from preemption under section 521(b) of the act:

(1) Massachusetts General Laws, Chapter 93, Section 72, to the extent that it requires a hearing test evaluation for a child under the age of 18.

(2) Massachusetts General Laws, Chapter 93, Section 74, except as provided in paragraph (6) of the Section, on the condition that, in enforcing this requirement, Massachusetts apply the

### § 808.73

definition of “used hearing aid” in § 801.420(a)(6) of this chapter.

(b) The following Massachusetts medical device requirements are preempted by section 521(a) of the act, and the Food and Drug Administration has denied them exemptions from preemption under section 521(b) of the act.

(1) Massachusetts General Laws, Chapter 93, Section 72, except as provided in paragraph (a) of this section.

(2) Massachusetts General Laws, Chapter 93, Section 74, to the extent that it requires that the sales receipt contain a statement that State law requires a medical examination and a hearing test evaluation before the sale of a hearing aid.

[45 FR 67326, Oct. 10, 1980]

### § 808.73 Minnesota.

The following Minnesota medical device requirements are preempted by section 521(a) of the act, and the Food and Drug Administration has denied them an exemption from preemption under section 521(b) of the act: Minnesota Statutes, sections 145.43 and 145.44.

[45 FR 67336, Oct. 10, 1980]

### § 808.74 Mississippi.

The following Mississippi medical device requirement is preempted by section 521(a) of the act, and the Food and Drug Administration has denied it an exemption from preemption under section 521(b) of the act: Mississippi Code, section 73-14-3(g)(9).

[45 FR 67336, Oct. 10, 1980]

### § 808.77 Nebraska.

(a) The following Nebraska medical device requirement is enforceable notwithstanding section 521(a) of the act because the Food and Drug Administration has exempted it from preemption under section 521(b) of the act: Nebraska Revised Statutes, section 71-4712(2)(c)(vi).

(b) The following Nebraska medical device requirement is preempted by section 521(a) of the act, and the Food and Drug Administration has denied it an exemption from preemption under section 521(b) of the act: Nebraska Re-

### 21 CFR Ch. I (4-1-20 Edition)

vised Statutes, section 71-4712(2)(c)(vii).

[45 FR 67336, Oct. 10, 1980]

### § 808.80 New Jersey.

(a) The following New Jersey medical device requirements are enforceable notwithstanding section 521(a) of the act because the Food and Drug Administration has exempted them from preemption under section 521(b) of the act:

(1) New Jersey Statutes Annotated, section 45:9A-23 on the condition that, in enforcing this requirement, New Jersey apply the definition of “used hearing aid” in § 801.420(a)(6) of this chapter;

(2) New Jersey Statutes Annotated, sections 45:9A-24 and 45:9A-25;

(3) Chapter 3, Section 5 of the Rules and Regulations adopted pursuant to New Jersey Statutes Annotated 45:9A-1 *et seq.* except as provided in paragraph (b) of this section.

(b) The following New Jersey medical device requirement is preempted by section 521(a) of the act, and the Food and Drug Administration has denied it an exemption from preemption under section 521(b) of the act: Chapter 3, Section 5 of the Rules and Regulations adopted pursuant to New Jersey Statutes Annotated 45:9A-1 *et seq.* to the extent that it requires testing to be conducted in an environment which meets or exceeds the American National Standards Institute S3.1 Standard.

[45 FR 67337, Oct. 10, 1980]

### § 808.81 New Mexico.

The following New Mexico medical device requirement is enforceable notwithstanding section 521(a) of the act because the Food and Drug Administration has exempted it from preemption under section 521(b) of the act: New Mexico Statutes Annotated, section 67-36-16(F).

[45 FR 67337, Oct. 10, 1980]

### § 808.82 New York.

(a) The following New York medical device requirements are enforceable notwithstanding section 521(a) of the act because the Food and Drug Administration has exempted them from preemption under section 521(b) of the act:



## Food and Drug Administration, HHS

## § 808.93

(1) General Business Law, Article 37, sections 784(3) and (4).

(2) Official Compilation of Codes, Rules and Regulations of the State of New York, Chapter V, Title 19, Subchapter G, section 191.10 and section 191.11(a) on the condition that, in enforcing these requirements, New York apply the definition of “used hearing aid” in §801.420(a)(6) of this chapter and section 191.11(b), (c), (d), and (e).

(b) The following New York medical device requirements are preempted by section 521(a) of the act, and the Food and Drug Administration has denied them an exemptions from preemption under section 521(b) of the act:

(1) General Business Law, Article 37, section 784.1.

(2) Official Compilation of Codes, Rules and Regulations of the State of New York, Chapter V, Title 19, Subchapter G, sections 191.6, 191.7, 191.8, and 191.9.

[45 FR 67337, Oct. 10, 1980]

### § 808.85 Ohio.

(a) The following Ohio medical device requirement is enforceable notwithstanding section 521(a) of the act because the Food and Drug Administration has exempted it from preemption under section 521(b) of the act: Ohio Revised Code, section 4747.09, the first two sentences with respect to disclosure of information to purchasers on the condition that, in enforcing these requirements, Ohio apply the definition of “used hearing aid” in §801.420(a)(6) of this chapter.

(b) The following Ohio medical device requirement is preempted by section 521(a) of the act, and the Food and Drug Administration has denied it an exemption from preemption under section 521(b) of the act: Ohio Revised Code, section 4747.09, the last two sentences with respect to medical examination of children.

[45 FR 67337, Oct. 10, 1980]

### § 808.87 Oregon.

(a) The following Oregon medical device requirements are enforceable notwithstanding section 521(a) of the act because the Food and Drug Administration has exempted them from preemption under section 521(b) of the act:

Oregon Revised Statutes, section 694.036 on the condition that, in enforcing this requirement, Oregon apply the definition of “used hearing aid” in §801.420(a)(6) of this chapter.

(b) The following Oregon medical device requirements are preempted by section 521(a) of the act, and the Food and Drug Administration has denied them exemptions from preemption under section 521(b) of the act: Oregon Revised Statutes, sections 694.136(6) and (7).

[45 FR 67337, Oct. 10, 1980, as amended at 53 FR 11252, Apr. 6, 1988]

### § 808.88 Pennsylvania.

(a) The following Pennsylvania medical device requirements are enforceable notwithstanding section 521(a) of the act because the Food and Drug Administration has exempted them from preemption under section 521(b) of the act: 35 Purdon’s Statutes 6700, section 504(4) on the condition that, in enforcing this requirement, Pennsylvania apply the definition of “used hearing aid” in §801.420(a)(6) of this chapter; section 506; and, section 507(2).

(b) The following Pennsylvania medical device requirement is preempted by section 521(a) of the act and the Food and Drug Administration has denied it an exemption from preemption under section 521(b) of the act: 35 Purdon’s Statutes 6700, section 402.

[45 FR 67326, Oct. 10, 1980]

### § 808.89 Rhode Island.

The following Rhode Island medical device requirements are preempted by section 521(a) of the act, and the Food and Drug Administration has denied them an exemption from preemption under section 521(b) of the act: Rhode Island General Laws, Section 5–49–2.1, and Section 2.2, to the extent that Section 2.2 requires hearing aid dispensers to keep copies of the certificates of need.

[45 FR 67337, Oct. 10, 1980]

### § 808.93 Texas.

(a) The following Texas medical device requirement is enforceable notwithstanding section 521(a) of the act

## § 808.97

because the Food and Drug Administration has exempted it from preemption under section 521(b) of the act: Vernon's Civil Statutes, Article 4566, section 14(b) on the condition that, in enforcing this requirement, Texas apply the definition of "used hearing aid" in § 801.420(a)(6) of this chapter.

(b) The following Texas medical device requirement is preempted by section 521(a) of the act, and the Food and Drug Administration has denied it an exemption from preemption under section 521(b) of the act: Vernon's Civil Statutes, Article 4566, section 14(d).

[45 FR 67337, Oct. 10, 1980]

## § 808.97 Washington.

(a) The following Washington medical device requirement is enforceable notwithstanding section 521(a) of the act because the Food and Drug Administration has exempted it from preemption under section 521(b) of the act: Revised Code of Washington 18.35.110(2)(e) (i) and (iii) on the condition that it is enforced in addition to the applicable requirements of this chapter.

(b) The following Washington medical device requirements are preempted by section 521(a) of the act, and the Food and Drug Administration has denied them an exemption from preemption under section 521(b) of the act: Revised Code of Washington 18.35.110(2)(e)(ii).

[45 FR 67337, Oct. 10, 1980]

## § 808.98 West Virginia.

(a) The following West Virginia medical device requirements are enforceable notwithstanding section 521(a) of the act because the Food and Drug Administration has exempted them from preemption: West Virginia Code, sections 30-26-14 (b) and (c) and section 30-26-15(a) on the condition that in enforcing section 30-26-15(a) West Virginia apply the definition of "used hearing aid" in § 801.420(a)(6) of this chapter.

(b) The following West Virginia medical device requirement is preempted by section 521(a) of the act, and the Food and Drug Administration has denied it an exemption from preemption

## 21 CFR Ch. I (4-1-20 Edition)

under section 521(b) of the act: West Virginia Code, section 30-26-14(a).

[45 FR 67337, Oct. 10, 1980, as amended at 53 FR 35314, Sept. 13, 1988]

## § 808.101 District of Columbia.

(a) The following District of Columbia medical device requirements are enforceable, notwithstanding section 521 of the act, because the Food and Drug Administration has exempted them from preemption under section 521(b) of the act:

(1) Act 2-79, section 5, to the extent that it requires an audiological evaluation for children under the age of 18.

(2) Act 2-79, section 6, on the condition that in enforcing section 6(a)(5), the District of Columbia apply the definition of "used hearing aid" in § 801.420(a)(6) of this chapter.

(b) The following District of Columbia medical device requirement is preempted by section 521(a) of the act, and the Food and Drug Administration has denied it an exemption from preemption under section 521(b) of the act: Act 2-79, section 5, except as provided in paragraph (a) of this section.

[46 FR 59236, Dec. 4, 1981]

## PART 809—IN VITRO DIAGNOSTIC PRODUCTS FOR HUMAN USE

### Subpart A—General Provisions

Sec.

809.3 Definitions.

809.4 Confidentiality of submitted information.

### Subpart B—Labeling

809.10 Labeling for in vitro diagnostic products.

809.11 Exceptions or alternatives to labeling requirements for in vitro diagnostic products for human use held by the Strategic National Stockpile.

### Subpart C—Requirements for Manufacturers and Producers

809.20 General requirements for manufacturers and producers of in vitro diagnostic products.

809.30 Restrictions on the sale, distribution and use of analyte specific reagents.

809.40 Restrictions on the sale, distribution, and use of OTC test sample collection systems for drugs of abuse testing.

AUTHORITY: 21 U.S.C. 331, 351, 352, 355, 360b, 360c, 360d, 360h, 360i, 360j, 371, 372, 374, 381.

### Subpart A—General Provisions

#### § 809.3 Definitions.

(a) *In vitro diagnostic products* are those reagents, instruments, and systems intended for use in the diagnosis of disease or other conditions, including a determination of the state of health, in order to cure, mitigate, treat, or prevent disease or its sequelae. Such products are intended for use in the collection, preparation, and examination of specimens taken from the human body. These products are devices as defined in section 201(h) of the Federal Food, Drug, and Cosmetic Act (the act), and may also be biological products subject to section 351 of the Public Health Service Act.

(b) A *product class* is all those products intended for use for a particular determination or for a related group of determinations or products with common or related characteristics or those intended for common or related uses. A class may be further divided into subclasses when appropriate.

(c) [Reserved]

(d) *Act* means the Federal Food, Drug, and Cosmetic Act.

[41 FR 6903, Feb. 13, 1976, as amended at 45 FR 7484, Feb. 1, 1980]

#### § 809.4 Confidentiality of submitted information.

Data and information submitted under § 809.10(c) that are shown to fall within the exemption established in § 20.61 of this chapter shall be treated as confidential by the Food and Drug Administration and any person to whom the data and information are referred. The Food and Drug Administration will determine whether information submitted will be treated as confidential in accordance with the provisions of part 20 of this chapter.

[45 FR 7484, Feb. 1, 1980]

### Subpart B—Labeling

#### § 809.10 Labeling for in vitro diagnostic products.

(a) The label for an in vitro diagnostic product shall state the following

information, except where such information is not applicable, or as otherwise specified in a standard for a particular product class or as provided in paragraph (e) of this section. Section 201(k) of the act provides that “a requirement made by or under authority of this act that any word, statement, or other information appear on the label shall not be considered to be complied with unless such word, statement, or other information also appears on the outside container or wrapper, if any there be, of the retail package of such article, or is easily legible through the outside container or wrapper.”

(1) The proprietary name and established name (common or usual name), if any.

(2) The intended use or uses of the product.

(3) For a reagent, a declaration of the established name (common or usual name), if any, and quantity, proportion or concentration of each reactive ingredient; and for a reagent derived from biological material, the source and a measure of its activity. The quantity, proportion, concentration, or activity shall be stated in the system generally used and recognized by the intended user, e.g., metric, international units, etc.

(4) A statement of warnings or precautions for users as established in the regulations contained in 16 CFR part 1500 and any other warnings appropriate to the hazard presented by the product; and a statement “For In Vitro Diagnostic Use” and any other limiting statements appropriate to the intended use of the product. The limiting statement appropriate to the intended use of a prescription in vitro diagnostic product shall bear the symbol statement “Rx only” or “~~R~~ only” or the statement “Caution: Federal law restricts this device to sale by or on the order of a \_\_\_\_\_”, the blank to be filled with the word “physician”, “dentist”, “veterinarian”, or with the descriptive designation of any other practitioner licensed by the law of the State in which the practitioner practices to use or order the use of the device.

(5) For a reagent, appropriate storage instructions adequate to protect the

stability of the product. When applicable, these instructions shall include such information as conditions of temperature, light, humidity, and other pertinent factors. For products requiring manipulation, such as reconstitution and/or mixing before use, appropriate storage instructions shall be provided for the reconstituted or mixed product which is to be stored in the original container. The basis for such instructions shall be determined by reliable, meaningful, and specific test methods such as those described in §211.166 of this chapter.

(6) For a reagent, a means by which the user may be assured that the product meets appropriate standards of identity, strength, quality and purity at the time of use. This shall be provided, both for the product as provided and for any resultant reconstituted or mixed product, by including on the label one or more of the following:

(i) An expiration date based upon the stated storage instructions.

(ii) A statement of an observable indication of an alteration of the product, e.g., turbidity, color change, precipitate, beyond its appropriate standards.

(iii) Instructions for a simple method by which the user can reasonably determine that the product meets its appropriate standards.

(7) For a reagent, a declaration of the net quantity of contents, expressed in terms of weight or volume, numerical count, or any combination of these or other terms which accurately reflect the contents of the package. The use of metric designations is encouraged, wherever appropriate. If more than a single determination may be performed using the product, any statement of the number of tests shall be consistent with instructions for use and amount of material provided.

(8) Name and place of business of manufacturer, packer, or distributor.

(9) A lot or control number, identified as such, from which it is possible to determine the complete manufacturing history of the product.

(i) If it is a multiple unit product, the lot or control number shall permit tracing the identity of the individual units.

(ii) For an instrument, the lot or control number shall permit tracing the identity of all functional subassemblies.

(iii) For multiple unit products which require the use of included units together as a system, all units should bear the same lot or control number, if appropriate, or other suitable uniform identification should be used.

(10) Except that for items in paragraphs (a) (1) through (9) of this section: (i) In the case of immediate containers too small or otherwise unable to accommodate a label with sufficient space to bear all such information and which are packaged within an outer container from which they are removed for use, the information required by paragraphs (a) (2), (3), (4), (5), (6) (ii), (iii) and (7) of this section may appear in the outer container labeling only.

(ii) In any case in which the presence of this information on the immediate container will interfere with the test, the information may appear on the outside container or wrapper rather than on the immediate container label.

(b) Labeling accompanying each product, e.g., a package insert, shall state in one place the following information in the format and order specified below, except where such information is not applicable, or as specified in a standard for a particular product class. The labeling for a multiple-purpose instrument used for diagnostic purposes, and not committed to specific diagnostic procedures or systems, may bear only the information indicated in paragraphs (b) (1), (2), (6), (14), and (15) of this section. The labeling for a reagent intended for use as a replacement in a diagnostic system may be limited to that information necessary to identify the reagent adequately and to describe its proper use in the system.

(1) The proprietary name and established name, i.e., common or usual name, if any.

(2) The intended use or uses of the product and the type of procedure, e.g., qualitative or quantitative.

(3) Summary and explanation of the test. Include a short history of the methodology, with pertinent references and a balanced statement of the special merits and limitations of this method

or product. If the product labeling refers to any other procedure, appropriate literature citations shall be included and the labeling shall explain the nature of any differences from the original and their effect on the results.

(4) The chemical, physical, physiological, or biological principles of the procedure. Explain concisely, with chemical reactions and techniques involved, if applicable.

(5) Reagents:

(i) A declaration of the established name (common or usual name), if any, and quantity, proportion or concentration of each reactive ingredient; and for biological material, the source and a measure of its activity. The quantity, proportion, concentration or activity shall be stated in the system generally used and recognized by the intended user, e.g., metric, international units, etc. A statement indicating the presence of and characterizing any catalytic or nonreactive ingredients, e.g., buffers, preservatives, stabilizers.

(ii) A statement of warnings or precautions for users as established in the regulations contained in 16 CFR part 1500 and any other warnings appropriate to the hazard presented by the product; and a statement "For In Vitro Diagnostic Use" and any other limiting statements appropriate to the intended use of the product. The limiting statement appropriate to the intended use of a prescription in vitro diagnostic product shall bear the symbol statement "Rx only" or "R only" or the statement "Caution: Federal law restricts this device to sale by or on the order of a \_\_\_\_\_", the blank to be filled with the word "physician", "dentist", "veterinarian", or with the descriptive designation of any other practitioner licensed by the law of the State in which the practitioner practices to use or order the use of the device.

(iii) Adequate instructions for reconstitution, mixing, dilution, etc.

(iv) Appropriate storage instructions adequate to protect the stability of the product. When applicable, these instructions shall include such information as conditions of temperature, light, humidity, and other pertinent factors. For products requiring manipulation, such as reconstitution and/or mixing before use, appropriate storage

instructions shall be provided for the reconstituted or mixed product. The basis for such instructions shall be determined by reliable, meaningful, and specific test methods such as those described in §211.166 of this chapter.

(v) A statement of any purification or treatment required for use.

(vi) Physical, biological, or chemical indications of instability or deterioration.

(6) Instruments:

(i) Use or function.

(ii) Installation procedures and special requirements.

(iii) Principles of operation.

(iv) Performance characteristics and specifications.

(v) Operating instructions.

(vi) Calibration procedures including materials and/or equipment to be used.

(vii) Operational precautions and limitations.

(viii) Hazards.

(ix) Service and maintenance information.

(7) Specimen collection and preparation for analysis, including a description of:

(i) Special precautions regarding specimen collection including special preparation of the patient as it bears on the validity of the test.

(ii) Additives, preservatives, etc., necessary to maintain the integrity of the specimen.

(iii) Known interfering substances.

(iv) Recommended storage, handling or shipping instructions for the protection and maintenance of stability of the specimen.

(8) Procedure: A step-by-step outline of recommended procedures from reception of the specimen to obtaining results. List any points that may be useful in improving precision and accuracy.

(i) A list of all materials provided, e.g., reagents, instruments and equipment, with instructions for their use.

(ii) A list of all materials required but not provided. Include such details as sizes, numbers, types, and quality.

(iii) A description of the amounts of reagents necessary, times required for specific steps, proper temperatures, wavelengths, etc.

(iv) A statement describing the stability of the final reaction material to

be measured and the time within which it shall be measured to assure accurate results.

(v) Details of calibration: Identify reference material. Describe preparation of reference sample(s), use of blanks, preparation of the standard curve, etc. The description of the range of calibration should include the highest and the lowest values measurable by the procedure.

(vi) Details of kinds of quality control procedures and materials required. If there is need for both positive and negative controls, this should be stated. State what are considered satisfactory limits of performance.

(9) Results: Explain the procedure for calculating the value of the unknown. Give an explanation for each component of the formula used for the calculation of the unknown. Include a sample calculation, step-by-step, explaining the answer. The values shall be expressed to the appropriate number of significant figures. If the test provides other than quantitative results, provide an adequate description of expected results.

(10) Limitation of the procedure: Include a statement of limitations of the procedure. State known extrinsic factors or interfering substances affecting results. If further testing, either more specific or more sensitive, is indicated in all cases where certain results are obtained, the need for the additional test shall be stated.

(11) Expected values: State the range(s) of expected values as obtained with the product from studies of various populations. Indicate how the range(s) was established and identify the population(s) on which it was established.

(12) Specific performance characteristics: Include, as appropriate, information describing such things as accuracy, precision, specificity, and sensitivity. These shall be related to a generally accepted method using biological specimens from normal and abnormal populations. Include a statement summarizing the data upon which the specific performance characteristics are based.

(13) Bibliography: Include pertinent references keyed to the text.

(14) Name and place of business of manufacturer, packer, or distributor.

(15) Date of issuance of the last revision of the labeling identified as such.

(c) A shipment or other delivery of an in vitro diagnostic product shall be exempt from the requirements of paragraphs (a) and (b) of this section and from a standard promulgated under part 861 provided that the following conditions are met:

(1) In the case of a shipment or delivery for an investigation subject to part 812, if there has been compliance with part 812; or

(2) In the case of a shipment or delivery for an investigation that is not subject to part 812 (see § 812.2(c)), if the following conditions are met:

(i) For a product in the laboratory research phase of development, and not represented as an effective in vitro diagnostic product, all labeling bears the statement, prominently placed: "For Research Use Only. Not for use in diagnostic procedures."

(ii) For a product being shipped or delivered for product testing prior to full commercial marketing (for example, for use on specimens derived from humans to compare the usefulness of the product with other products or procedures which are in current use or recognized as useful), all labeling bears the statement, prominently placed: "For Investigational Use Only. The performance characteristics of this product have not been established."

(d) The labeling of general purpose laboratory reagents (e.g., hydrochloric acid) and equipment (e.g., test tubes and pipettes) whose uses are generally known by persons trained in their use need not bear the directions for use required by § 809.10(a) and (b), if their labeling meets the requirements of this paragraph.

(1) The label of a reagent shall bear the following information:

(i) The proprietary name and established name (common or usual name), if any, of the reagent.

(ii) A declaration of the established name (common or usual name), if any, and quantity, proportion or concentration of the reagent ingredient (e.g., hydrochloric acid: Formula weight 36.46, assay 37.9 percent, specific gravity 1.192 at 60 °F); and for a reagent derived

from biological material, the source and where applicable a measure of its activity. The quantity, proportion, concentration or activity shall be stated in the system generally used and recognized by the intended user, e.g., metric, international units, etc.

(iii) A statement of the purity and quality of the reagent, including a quantitative declaration of any impurities present. The requirement for this information may be met by a statement of conformity with a generally recognized and generally available standard which contains the same information, e.g., those established by the American Chemical Society, U.S. Pharmacopeia, National Formulary, National Research Council.

(iv) A statement of warnings or precautions for users as established in the regulations contained in 16 CFR part 1500 and any other warnings appropriate to the hazard presented by the product; and a statement "For Laboratory Use."

(v) Appropriate storage instructions adequate to protect the stability of the product. When applicable, these instructions shall include such information as conditions of temperature, light, humidity, and other pertinent factors. The basis for such information shall be determined by reliable, meaningful, and specific test methods such as those described in §211.166 of this chapter.

(vi) A declaration of the net quantity of contents, expressed in terms of weight or volume, numerical count, or any combination of these or other terms which accurately reflect the contents of the package. The use of metric designations is encouraged, wherever appropriate.

(vii) Name and place of business of manufacturer, packer, or distributor.

(viii) A lot or control number, identified as such, from which it is possible to determine the complete manufacturing history of the product.

(ix) In the case of immediate containers too small or otherwise unable to accommodate a label with sufficient space to bear all such information, and which are packaged within an outer container from which they are removed for use, the information required by paragraphs (d)(1)(ii), (iii), (iv), (v), and

(vi) of this section may appear in the outer container labeling only.

(2) The label of general purpose laboratory equipment, e.g., a beaker or a pipette, shall bear a statement adequately describing the product, its composition, and physical characteristics if necessary for its proper use.

(e)(1) The labeling for analyte specific reagents (e.g., monoclonal antibodies, deoxyribonucleic acid (DNA) probes, viral antigens, ligands) shall bear the following information:

(i) The proprietary name and established name (common or usual name), if any, of the reagent;

(ii) A declaration of the established name (common or usual name), if any;

(iii) The quantity, proportion, or concentration of the reagent ingredient; and for a reagent derived from biological material, the source and where applicable, a measure of its activity. The quantity, proportion, concentration, or activity shall be stated in the system generally used and recognized by the intended user, e.g., metric, international units, etc.;

(iv) A statement of the purity and quality of the reagent, including a quantitative declaration of any impurities present and method of analysis or characterization. The requirement for this information may be met by a statement of conformity with a generally recognized and generally available standard that contains the same information, e.g., those established by the American Chemical Society, U.S. Pharmacopeia, National Formulary, and National Research Council. The labeling may also include information concerning chemical/molecular composition, nucleic acid sequence, binding affinity, cross-reactivities, and interaction with substances of known clinical significance;

(v) A statement of warnings or precautions for users as established in the regulations contained in 16 CFR part 1500 and any other warnings appropriate to the hazard presented by the product;

(vi) The date of manufacture and appropriate storage instructions adequate to protect the stability of the product. When applicable, these instructions shall include such information as conditions of temperature,

light, humidity, date of expiration, and other pertinent factors. The basis for such instructions shall be determined by reliable, meaningful, and specific test methods, such as those described in § 211.166 of this chapter;

(vii) A declaration of the net quantity of contents, expressed in terms of weight or volume, numerical count, or any combination of these or other terms that accurately reflect the contents of the package. The use of metric designations is encouraged, wherever appropriate;

(viii) The name and place of business of manufacturer, packer, or distributor;

(ix) A lot or control number, identified as such, from which it is possible to determine the complete manufacturing history of the product;

(x) For class I exempt ASR's, the statement: "Analyte Specific Reagent. Analytical and performance characteristics are not established"; and

(xi) For class II and III ASR's, the statement: "Analyte Specific Reagent. Except as a component of the approved/cleared test (Name of approved/cleared test), analytical and performance characteristics of this ASR are not established."

(2) In the case of immediate containers too small or otherwise unable to accommodate a label with sufficient space to bear all such information, and which are packaged within an outer container from which they are removed for use, the information required by paragraphs (e)(1) through (e)(6) of this section may appear in the outer container labeling only.

(f) The labeling for over-the-counter (OTC) test sample collection systems for drugs of abuse testing shall bear the following information in language appropriate for the intended users:

(1) Adequate instructions for specimen collection and handling, and for preparation and mailing of the specimen to the laboratory for testing.

(2) An identification system to ensure that specimens are not mixed up or otherwise misidentified at the laboratory, and that user anonymity is maintained.

(3) The intended use or uses of the product, including what drugs are to be identified in the specimen, a quan-

titative description of the performance characteristics for those drugs (e.g., sensitivity and specificity) in terms understandable to lay users, and the detection period.

(4) A statement that confirmatory testing will be conducted on all samples that initially test positive.

(5) A statement of warnings or precautions for users as established in the regulations contained in 16 CFR part 1500 and any other warnings appropriate to the hazard presented by the product.

(6) Adequate instructions on how to obtain test results from a person who can explain their meaning, including the probability of false positive and false negative results, as well as how to contact a trained health professional if additional information on interpretation of test results from the laboratory or followup counseling is desired.

(7) Name and place of business of the manufacturer, packer, or distributor.

(g)(1) The applicant may provide the labeling information referenced in this section in the form of:

(i) A symbol accompanied by explanatory text adjacent to the symbol;

(ii) A symbol not accompanied by adjacent explanatory text that:

(A) Is contained in a standard that FDA recognizes under its authority in section 514(c) of the act;

(B) Is used according to the specifications for use of the symbol set forth in FDA's section 514(c) recognition; and

(C) Is explained in a paper or electronic symbols glossary that is included in the labeling for the device and the labeling on or within the package containing the device bears a prominent and conspicuous statement identifying the location of the symbols glossary that is written in English or, in the case of articles distributed solely in Puerto Rico or in a Territory where the predominant language is one other than English, the predominant language may be used;

(iii) A symbol not accompanied by adjacent explanatory text that:

(A) Is established in a standard developed by a standards development organization (SDO);

(B) Is not contained in a standard that is recognized by FDA under its authority in section 514(c) of the act or is



contained in a standard that is recognized by FDA but is not used according to the specifications for use of the symbol set forth in FDA's section 514(c) recognition;

(C) Is determined by the manufacturer to be likely to be read and understood by the ordinary individual under customary conditions of purchase and use in compliance with section 502(c) of the act;

(D) Is used according to the specifications for use of the symbol set forth in the SDO-developed standard; and

(E) Is explained in a paper or electronic symbols glossary that is included in the labeling for the device and the labeling on or within the package containing the device bears a prominent and conspicuous statement identifying the location of the symbols glossary that is written in English or, in the case of articles distributed solely in Puerto Rico or in a Territory where the predominant language is one other than English, the predominant language may be used; or

(iv) The symbol statement "Rx only" or "R only" used as provided under paragraphs (a)(4) and (b)(5)(ii) of this section.

(2) The use of symbols in device labeling which do not meet the requirements of paragraph (g)(1) of this section renders a device misbranded under section 502(c) of the act.

(3) For purposes of paragraph (g)(1) of this section:

(i) An SDO is an organization that is nationally or internationally recognized and that follows a process for standard development that is transparent, (*i.e.*, open to public scrutiny), where the participation is balanced, where an appeals process is included, where the standard is not in conflict with any statute, regulation, or policy under which FDA operates, and where the standard is national or international in scope.

(ii) The term "symbols glossary" means a compiled listing of:

(A) Each SDO-established symbol used in the labeling for the device;

(B) The title and designation number of the SDO-developed standard containing the symbol;

(C) The title of the symbol and its reference number, if any, in the standard; and

(D) The meaning or explanatory text for the symbol as provided in the FDA recognition or, if FDA has not recognized the standard or portion of the standard in which the symbol is located or the symbol is not used according to the specifications for use of the symbol set forth in FDA's section 514(c) recognition, the explanatory text as provided in the standard.

[41 FR 6903, Feb. 13, 1976, as amended at 45 FR 3750, Jan. 18, 1980; 45 FR 7484, Feb. 1, 1980; 47 FR 41107, Sept. 17, 1982; 47 FR 51109, Nov. 12, 1982; 48 FR 34470, July 29, 1983; 62 FR 62259, Nov. 21, 1997; 65 FR 18234, Apr. 7, 2000; 81 FR 38391, June 15, 2016]

**§ 809.11 Exceptions or alternatives to labeling requirements for in vitro diagnostic products for human use held by the Strategic National Stockpile.**

(a) The appropriate FDA Center Director may grant an exception or alternative to any provision listed in paragraph (f) of this section and not explicitly required by statute, for specified lots, batches, or other units of an in vitro diagnostic product for human use, if the Center Director determines that compliance with such labeling requirement could adversely affect the safety, effectiveness, or availability of such products that are or will be included in the Strategic National Stockpile.

(b)(1)(i) A Strategic National Stockpile official or any entity that manufactures (including labeling, packing, relabeling, or repackaging), distributes, or stores an in vitro diagnostic product for human use that is or will be included in the Strategic National Stockpile may submit, with written concurrence from a Strategic National Stockpile official, a written request for an exception or alternative described in paragraph (a) of this section to the Center Director.

(ii) The Center Director may grant an exception or alternative described in paragraph (a) of this section on his or her own initiative.

(2) A written request for an exception or alternative described in paragraph (a) of this section must:

(i) Identify the specified lots, batches, or other units of an in vitro diagnostic product for human use that would be subject to the exception or alternative;

(ii) Identify the labeling provision(s) listed in paragraph (f) of this section that are the subject of the exception or alternative request;

(iii) Explain why compliance with such labeling provision(s) could adversely affect the safety, effectiveness, or availability of the specified lots, batches, or other units of the in vitro diagnostic product for human use that are or will be held in the Strategic National Stockpile;

(iv) Describe any proposed safeguards or conditions that will be implemented so that the labeling of the product includes appropriate information necessary for the safe and effective use of the product, given the anticipated circumstances of use of the product;

(v) Provide a draft of the proposed labeling of the specified lots, batches, or other units of the in vitro diagnostic products for human use subject to the exception or alternative; and

(vi) Provide any other information requested by the Center Director in support of the request.

(c) The Center Director must respond in writing to all requests under this section. The Center Director may impose appropriate conditions or safeguards when granting such an exception or alternative under this section.

(d) A grant of an exception or alternative under this section will include any safeguards or conditions deemed appropriate by the Center Director to ensure that the labeling of the product subject to the exception or alternative includes the information necessary for the safe and effective use of the product, given the anticipated circumstances of use.

(e) If the Center Director grants a request for an exception or alternative to the labeling requirements under this section:

(1) The Center Director may determine that the submission and grant of a written request under this section satisfies the provisions relating to premarket notification submissions under § 807.81(a)(3) of this chapter.

(2)(i) For a Premarket Approval Application (PMA)-approved in vitro diagnostic product for human use, the submission and grant of a written request under this section satisfies the provisions relating to submission of PMA supplements under § 814.39 of this chapter; however,

(ii) The grant of the request must be identified in a periodic report under § 814.84 of this chapter.

(f) The Center Director may grant an exception or alternative under this section to the following provisions of this part, to the extent that the requirements in these provisions are not explicitly required by statute:

(1) § 809.10(a)(1) through (a)(6) and (a)(9);

(2) § 809.10(b);

(3) § 809.10(c)(2);

(4) § 809.10(d)(1)(i) through (d)(1)(v), (d)(1)(viii), and (d)(2); and

(5) § 809.10(e)(1)(i) through (e)(1)(vi) and (e)(1)(ix) through (e)(1)(xi).

[72 FR 73601, Dec. 28, 2007]

### Subpart C—Requirements for Manufacturers and Producers

#### § 809.20 General requirements for manufacturers and producers of in vitro diagnostic products.

(a) [Reserved]

(b) *Compliance with good manufacturing practices.* In vitro diagnostic products shall be manufactured in accordance with the good manufacturing practices requirements found in part 820 of this chapter and, if applicable, with § 610.44 of this chapter.

[41 FR 6903, Feb. 13, 1976, as amended at 42 FR 42530, Aug. 23, 1977; 43 FR 31527, July 21, 1978; 66 FR 31165, June 11, 2001]

#### § 809.30 Restrictions on the sale, distribution and use of analyte specific reagents.

(a) Analyte specific reagents (ASR's) (§ 864.4020 of this chapter) are restricted devices under section 520(e) of the Federal Food, Drugs, and Cosmetic Act (the act) subject to the restrictions set forth in this section.

(b) ASR's may only be sold to:

(1) In vitro diagnostic manufacturers;

(2) Clinical laboratories regulated under the Clinical Laboratory Improvement Amendments of 1988 (CLIA), as

qualified to perform high complexity testing under 42 CFR part 493 or clinical laboratories regulated under VHA Directive 1106 (available from Department of Veterans Affairs, Veterans Health Administration, Washington, DC 20420); and

(3) Organizations that use the reagents to make tests for purposes other than providing diagnostic information to patients and practitioners, e.g., forensic, academic, research, and other nonclinical laboratories.

(c) ASR's must be labeled in accordance with §809.10(e).

(d) Advertising and promotional materials for ASR's:

(1) Shall include the identity and purity (including source and method of acquisition) of the analyte specific reagent and the identity of the analyte;

(2) Shall include the statement for class I exempt ASR's: "Analyte Specific Reagent. Analytical and performance characteristics are not established";

(3) Shall include the statement for class II or III ASR's: "Analyte Specific Reagent. Except as a component of the approved/cleared test (name of approved/cleared test), analytical and performance characteristics are not established"; and

(4) Shall not make any statement regarding analytical or clinical performance.

(e) The laboratory that develops an in-house test using the ASR shall inform the ordering person of the test result by appending to the test report the statement: "This test was developed and its performance characteristics determined by (Laboratory Name). It has not been cleared or approved by the U.S. Food and Drug Administration." This statement would not be applicable or required when test results are generated using the test that was cleared or approved in conjunction with review of the class II or III ASR.

(f) Ordering in-house tests that are developed using analyte specific reagents is limited under section 520(e) of the act by physicians and other persons authorized by applicable State law to order such tests.

(g) The restrictions in paragraphs (c) through (f) of this section do not apply when reagents that otherwise meet the

analyte specific reagent definition are sold to:

(1) In vitro diagnostic manufacturers; or

(2) Organizations that use the reagents to make tests for purposes other than providing diagnostic information to patients and practitioners, e.g., forensic, academic, research, and other nonclinical laboratories.

[62 FR 62259, Nov. 21, 1997]

**§809.40 Restrictions on the sale, distribution, and use of OTC test sample collection systems for drugs of abuse testing.**

(a) Over-the-counter (OTC) test sample collection systems for drugs of abuse testing (§864.3260 of this chapter) are restricted devices under section 520(e) of the Act subject to the restrictions set forth in this section.

(b) Sample testing shall be performed in a laboratory using screening tests that have been approved, cleared, or otherwise recognized by the Food and Drug Administration as accurate and reliable for the testing of such specimens for identifying drugs of abuse or their metabolites.

(c) The laboratory performing the test(s) shall have, and shall be recognized as having, adequate capability to reliably perform the necessary screening and confirmatory tests, including adequate capability to perform integrity checks of the biological specimens for possible adulteration.

(d) All OTC test sample collection systems for drugs of abuse testing shall be labeled in accordance with §809.10(f) and shall provide an adequate system to communicate the proper interpretation of test results from the laboratory to the lay purchaser.

[65 FR 18234, Apr. 7, 2000]

**PART 810—MEDICAL DEVICE  
RECALL AUTHORITY**

**Subpart A—General Provisions**

Sec.	
810.1	Scope.
810.2	Definitions.
810.3	Computation of time.
810.4	Service of orders.

**Subpart B—Mandatory Medical Device Recall Procedures**

- 810.10 Cease distribution and notification order.
- 810.11 Regulatory hearing.
- 810.12 Written request for review of cease distribution and notification order.
- 810.13 Mandatory recall order.
- 810.14 Cease distribution and notification or mandatory recall strategy.
- 810.15 Communications concerning a cease distribution and notification or mandatory recall order.
- 810.16 Cease distribution and notification or mandatory recall order status reports.
- 810.17 Termination of a cease distribution and notification or mandatory recall order.
- 810.18 Public notice.

AUTHORITY: 21 U.S.C. 321, 331, 332, 333, 334, 351, 352, 355, 360h, 360i, 371, 374, 375.

SOURCE: 61 FR 59018, Nov. 20, 1996, unless otherwise noted.

**Subpart A—General Provisions**

**§ 810.1 Scope.**

Part 810 describes the procedures that the Food and Drug Administration will follow in exercising its medical device recall authority under section 518(e) of the Federal Food, Drug, and Cosmetic Act.

**§ 810.2 Definitions.**

As used in this part:

- (a) *Act* means the Federal Food, Drug, and Cosmetic Act.
- (b) *Agency* or *FDA* means the Food and Drug Administration.
- (c) *Cease distribution and notification strategy* or *mandatory recall strategy* means a planned, specific course of action to be taken by the person named in a cease distribution and notification order or in a mandatory recall order, which addresses the extent of the notification or recall, the need for public warnings, and the extent of effectiveness checks to be conducted.
- (d) *Consignee* means any person or firm that has received, purchased, or used a device that is subject to a cease distribution and notification order or a mandatory recall order. Consignee does not mean lay individuals or patients, i.e., nonhealth professionals.
- (e) *Correction* means repair, modification, adjustment, relabeling, destruction, or inspection (including patient

monitoring) of a device, without its physical removal from its point of use to some other location.

(f) *Device user facility* means a hospital, ambulatory surgical facility, nursing home, or outpatient treatment or diagnostic facility that is not a physician's office.

(g) *Health professionals* means practitioners, including physicians, nurses, pharmacists, dentists, respiratory therapists, physical therapists, technologists, or any other practitioners or allied health professionals that have a role in using a device for human use.

(h) *Human cell, tissue, or cellular or tissue-based product (HCT/P) regulated as a device* means an HCT/P as defined in § 1271.3(d) of this chapter that does not meet the criteria in § 1271.10(a) and that is also regulated as a device.

(i) *Reasonable probability* means that it is more likely than not that an event will occur.

(j) *Serious, adverse health consequence* means any significant adverse experience, including those that may be either life-threatening or involve permanent or long-term injuries, but excluding injuries that are nonlife-threatening and that are temporary and reasonably reversible.

(k) *Recall* means the correction or removal of a device for human use where FDA finds that there is a reasonable probability that the device would cause serious, adverse health consequences or death.

(l) *Removal* means the physical removal of a device from its point of use to some other location for repair, modification, adjustment, relabeling, destruction, or inspection.

(m) *Unique device identifier (UDI)* means an identifier that adequately identifies a device through its distribution and use by meeting the requirements of § 830.20 of this chapter. A unique device identifier is composed of:

(1) A *device identifier*—a mandatory, fixed portion of a UDI that identifies the specific version or model of a device and the labeler of that device; and

(2) A *production identifier*—a conditional, variable portion of a UDI that identifies one or more of the following when included on the label of the device:

- (i) The lot or batch within which a device was manufactured;
- (ii) The serial number of a specific device;
- (iii) The expiration date of a specific device;
- (iv) The date a specific device was manufactured.
- (v) For an HCT/P regulated as a device, the distinct identification code required by § 1271.290(c) of this chapter.

[61 FR 59018, Nov. 20, 1996, as amended at 78 FR 58821, Sept. 24, 2013]

#### § 810.3 Computation of time.

In computing any period of time prescribed or allowed by this part, the day of the act or event from which the designated period of time begins to run shall not be included. The computation of time is based only on working days.

#### § 810.4 Service of orders.

Orders issued under this part will be served in person by a designated employee of FDA, or by certified or registered mail or similar mail delivery service with a return receipt record reflecting receipt, to the named person or designated agent at the named person's or designated agent's last known address in FDA's records.

### Subpart B—Mandatory Medical Device Recall Procedures

#### § 810.10 Cease distribution and notification order.

(a) If, after providing the appropriate person with an opportunity to consult with the agency, FDA finds that there is a reasonable probability that a device intended for human use would cause serious, adverse health consequences or death, the agency may issue a cease distribution and notification order requiring the person named in the order to immediately:

- (1) Cease distribution of the device;
- (2) Notify health professionals and device user facilities of the order; and
- (3) Instruct these professionals and device user facilities to cease use of the device.

(b) FDA will include the following information in the order:

- (1) The requirements of the order relating to cessation of distribution and

notification of health professionals and device user facilities;

(2) Pertinent descriptive information to enable accurate and immediate identification of the device subject to the order, including, where known:

- (i) The brand name of the device;
- (ii) The common name, classification name, or usual name of the device;
- (iii) The model, catalog, or product code numbers of the device;
- (iv) The manufacturing lot numbers or serial numbers of the device or other identification numbers; and

(v) The unique device identifier (UDI) that appears on the device label or on the device package; and

(3) A statement of the grounds for FDA's finding that there is a reasonable probability that the device would cause serious, adverse health consequences or death.

(c) FDA may also include in the order a model letter for notifying health professionals and device user facilities of the order and a requirement that notification of health professionals and device user facilities be completed within a specified timeframe. The model letter will include the key elements of information that the agency in its discretion has determined, based on the circumstances surrounding the issuance of each order, are necessary to inform health professionals and device user facilities about the order.

(d) FDA may also require that the person named in the cease distribution and notification order submit any or all of the following information to the agency by a time specified in the order:

- (1) The total number of units of the device produced and the timespan of the production;
- (2) The total number of units of the device estimated to be in distribution channels;
- (3) The total number of units of the device estimated to be distributed to health professionals and device user facilities;
- (4) The total number of units of the device estimated to be in the hands of home users;
- (5) Distribution information, including the names and addresses of all consignees;
- (6) A copy of any written communication used by the person named in the

## §810.11

## 21 CFR Ch. I (4–1–20 Edition)

order to notify health professionals and device user facilities;

(7) A proposed strategy for complying with the cease distribution and notification order;

(8) Progress reports to be made at specified intervals, showing the names and addresses of health professionals and device user facilities that have been notified, names of specific individuals contacted within device user facilities, and the dates of such contacts; and

(9) The name, address, and telephone number of the person who should be contacted concerning implementation of the order.

(e) FDA will provide the person named in a cease distribution and notification order with an opportunity for a regulatory hearing on the actions required by the cease distribution and notification order and on whether the order should be modified, or vacated, or amended to require a mandatory recall of the device.

(f) FDA will also provide the person named in the cease distribution and notification order with an opportunity, in lieu of a regulatory hearing, to submit a written request to FDA asking that the order be modified, or vacated, or amended.

(g) FDA will include in the cease distribution and notification order the name, address, and telephone number of an agency employee to whom any request for a regulatory hearing or agency review is to be addressed.

[61 FR 59018, Nov. 20, 1996, as amended at 78 FR 58821, Sept. 24, 2013]

### §810.11 Regulatory hearing.

(a) Any request for a regulatory hearing shall be submitted in writing to the agency employee identified in the order within the timeframe specified by FDA. Under §16.22(b) of this chapter, this timeframe ordinarily will not be fewer than 3 working days after receipt of the cease distribution and notification order. However, as provided in §16.60(h) of this chapter, the Commissioner of Food and Drugs or presiding officer may waive, suspend, or modify any provision of part 16 under §10.19 of this chapter, including those pertaining to the timing of the hearing. As provided in §16.26(a), the Commis-

sioner or presiding officer may deny a request for a hearing, in whole or in part, if he or she determines that no genuine and substantial issue of fact is raised by the material submitted in the request.

(b) If a request for a regulatory hearing is granted, the regulatory hearing shall be limited to:

(1) Reviewing the actions required by the cease distribution and notification order, determining if FDA should affirm, modify, or vacate the order, and addressing an appropriate cease distribution and notification strategy; and

(2) Determining whether FDA should amend the cease distribution and notification order to require a recall of the device that was the subject of the order. The hearing may also address the actions that might be required by a recall order, including an appropriate recall strategy, if FDA later orders a recall.

(c) If a request by the person named in a cease distribution and notification order for a regulatory hearing is granted, the regulatory hearing will be conducted in accordance with the procedures set out in section 201(x) of the act (21 U.S.C. 321(x)) and part 16 of this chapter, except that the order issued under §810.10, rather than a notice under §16.22(a) of this chapter, provides the notice of opportunity for a hearing and is part of the administrative record of the regulatory hearing under §16.80(a) of this chapter. As provided in §16.60(h) of this chapter, the Commissioner of Food and Drugs or presiding officer may waive, suspend, or modify any provision of part 16 under §10.19 of this chapter. As provided in §16.26(b), after the hearing commences, the presiding officer may issue a summary decision on any issue if the presiding officer determines that there is no genuine and substantial issue of fact respecting that issue.

(d) If the person named in the cease distribution and notification order does not request a regulatory hearing within the timeframe specified by FDA in the cease distribution and notification order, that person will be deemed to have waived his or her right to request a hearing.

(e) The presiding officer will ordinarily hold any regulatory hearing requested under paragraph (a) of this section no fewer than 2 working days after receipt of the request for a hearing, under § 16.24(e) of this chapter, and no later than 10 working days after the date of issuance of the cease distribution and notification order. However, FDA and the person named in the order may agree to a later date or the presiding officer may determine that the hearing should be held in fewer than 2 days. Moreover, as provided for in § 16.60(h) of this chapter, the Commissioner of Food and Drugs or presiding officer may waive, suspend, or modify any provision of part 16 under § 10.19 of this chapter, including those pertaining to the timing of the hearing. After the presiding officer prepares a written report of the hearing and the agency issues a final decision based on the report, the presiding officer shall provide the requestor written notification of the final decision to affirm, modify, or vacate the order or to amend the order to require a recall of the device within 15 working days of conducting a regulatory hearing.

**§ 810.12 Written request for review of cease distribution and notification order.**

(a) In lieu of requesting a regulatory hearing under § 810.11, the person named in a cease distribution and notification order may submit a written request to FDA asking that the order be modified or vacated. Such person shall address the written request to the agency employee identified in the order and shall submit the request within the timeframe specified in the order, unless FDA and the person named in the order agree to a later date.

(b) A written request for review of a cease distribution and notification order shall identify each ground upon which the requestor relies in asking that the order be modified or vacated, as well as addressing an appropriate cease distribution and notification strategy, and shall address whether the order should be amended to require a recall of the device that was the subject of the order and the actions re-

quired by such a recall order, including an appropriate recall strategy.

(c) The agency official who issued the cease distribution and notification order shall provide the requestor written notification of the agency's decision to affirm, modify, or vacate the order or amend the order to require a recall of the device within 15 working days of receipt of the written request. The agency official shall include in this written notification:

(1) A statement of the grounds for the decision to affirm, modify, vacate, or amend the order; and

(2) The requirements of any modified or amended order.

**§ 810.13 Mandatory recall order.**

(a) If the person named in a cease distribution and notification order does not request a regulatory hearing or submit a request for agency review of the order, or, if the Commissioner of Food and Drugs or the presiding officer denies a request for a hearing, or, if after conducting a regulatory hearing under § 810.11 or completing agency review of a cease distribution and notification order under § 810.12, FDA determines that the order should be amended to require a recall of the device with respect to which the order was issued, FDA shall amend the order to require such a recall. FDA shall amend the order to require such a recall within 15 working days of issuance of a cease distribution and notification order if a regulatory hearing or agency review of the order is not requested, or within 15 working days of denying a request for a hearing, or within 15 working days of completing a regulatory hearing under § 810.11, or within 15 working days of receipt of a written request for review of a cease distribution and notification order under § 810.12.

(b) In a mandatory recall order, FDA may:

(1) Specify that the recall is to extend to the wholesale, retail, or user level;

(2) Specify a timetable in accordance with which the recall is to begin and be completed;

(3) Require the person named in the order to submit to the agency a proposed recall strategy, as described in § 810.14, and periodic reports describing

## §810.14

## 21 CFR Ch. I (4–1–20 Edition)

the progress of the mandatory recall, as described in §810.16; and

(4) Provide the person named in the order with a model recall notification letter that includes the key elements of information that FDA has determined are necessary to inform health professionals and device user facilities.

(c) FDA will not include in a mandatory recall order a requirement for:

(1) Recall of a device from individuals; or

(2) Recall of a device from device user facilities, if FDA determines that the risk of recalling the device from the facilities presents a greater health risk than the health risk of not recalling the device from use, unless the device can be replaced immediately with an equivalent device.

(d) FDA will include in a mandatory recall order provisions for notification to individuals subject to the risks associated with use of the device. If a significant number of such individuals cannot be identified, FDA may notify such individuals under section 705(b) of the act.

### **§810.14 Cease distribution and notification or mandatory recall strategy.**

(a) *General.* The person named in a cease distribution and notification order issued under §810.10 shall comply with the order, which FDA will fashion as appropriate for the individual circumstances of the case. The person named in a cease distribution and notification order modified under §810.11(e) or §810.12(c) or a mandatory recall order issued under §810.13 shall develop a strategy for complying with the order that is appropriate for the individual circumstances and that takes into account the following factors:

(1) The nature of the serious, adverse health consequences related to the device;

(2) The ease of identifying the device;

(3) The extent to which the risk presented by the device is obvious to a health professional or device user facility; and

(4) The extent to which the device is used by health professionals and device user facilities.

(b) *Submission and review.* (1) The person named in the cease distribution and notification order modified under

§810.11(e) or §810.12(c) or mandatory recall order shall submit a copy of the proposed strategy to the agency within the timeframe specified in the order.

(2) The agency will review the proposed strategy and make any changes to the strategy that it deems necessary within 7 working days of receipt of the proposed strategy. The person named in the order shall act in accordance with a strategy determined by FDA to be appropriate.

(c) *Elements of the strategy.* A proposed strategy shall meet all of the following requirements:

(1)(i) The person named in the order shall specify the level in the chain of distribution to which the cease distribution and notification order or mandatory recall order is to extend as follows:

(A) Consumer or user level, e.g., health professionals, consignee, or device user facility level, including any intermediate wholesale or retail level; or

(B) Retail level, to the level immediately preceding the consumer or user level, and including any intermediate level; or

(C) Wholesale level.

(ii) The person named in the order shall not recall a device from individuals; and

(iii) The person named in the order shall not recall a device from device user facilities if FDA notifies the person not to do so because of a risk determination under §810.13(c)(2).

(2) The person named in a recall order shall ensure that the strategy provides for notice to individuals subject to the risks associated with use of the recalled device. The notice may be provided through the individuals' health professionals if FDA determines that such consultation is appropriate and would be the most effective method of notifying patients.

(3) Effectiveness checks by the person named in the order are required to verify that all health professionals, device user facilities, consignees, and individuals, as appropriate, have been notified of the cease distribution and notification order or mandatory recall order and of the need to take appropriate action. The person named in the cease distribution and notification



order or the mandatory recall order shall specify in the strategy the method(s) to be used in addition to written communications as required by § 810.15, i.e., personal visits, telephone calls, or a combination thereof to contact all health professionals, device user facilities, consignees, and individuals, as appropriate. The agency may conduct additional audit checks where appropriate.

**§ 810.15 Communications concerning a cease distribution and notification or mandatory recall order.**

(a) *General.* The person named in a cease distribution and notification order issued under § 810.10 or a mandatory recall order issued under § 810.13 is responsible for promptly notifying each health professional, device user facility, consignee, or individual, as appropriate, of the order. In accordance with § 810.10(c) or § 810.13(b)(4), FDA may provide the person named in the cease distribution and notification or mandatory recall order with a model letter for notifying each health professional, device user facility, consignee, or individual, as appropriate, of the order. However, if FDA does not provide the person named in the cease distribution and notification or mandatory recall order with a model letter, the person named in a cease distribution and notification order issued under § 810.10, or a mandatory recall order issued under § 810.13, is responsible for providing such notification. The purpose of the communication is to convey:

- (1) That FDA has found that there is a reasonable probability that use of the device would cause a serious, adverse health consequence or death;
- (2) That the person named in the order has ceased distribution of the device;
- (3) That health professionals and device user facilities should cease use of the device immediately;
- (4) Where appropriate, that the device is subject to a mandatory recall order; and
- (5) Specific instructions on what should be done with the device.

(b) *Implementation.* The person named in a cease distribution and notification order, or a mandatory recall order,

shall notify the appropriate person(s) of the order by verified written communication, e.g., telegram, mailgram, or fax. The written communication and any envelope in which it is sent or enclosed shall be conspicuously marked, preferably in bold red ink: “URGENT—[DEVICE CEASE DISTRIBUTION AND NOTIFICATION ORDER] or [MANDATORY DEVICE RECALL ORDER].” Telephone calls or other personal contacts may be made in addition to, but not as a substitute for, the verified written communication, and shall be documented in an appropriate manner.

(c) *Contents.* The person named in the order shall ensure that the notice of a cease distribution and notification order or mandatory recall order:

- (1) Is brief and to the point;
- (2) Identifies clearly the device, size, lot number(s), code(s), or serial number(s), and any other pertinent descriptive information to facilitate accurate and immediate identification of the device;
- (3) Explains concisely the serious, adverse health consequences that may occur if use of the device were continued;
- (4) Provides specific instructions on what should be done with the device;
- (5) Provides a ready means for the recipient of the communication to confirm receipt of the communication and to notify the person named in the order of the actions taken in response to the communication. Such means may include, but are not limited to, the return of a postage-paid, self-addressed post card or a toll-free call to the person named in the order; and
- (6) Does not contain irrelevant qualifications, promotional materials, or any other statement that may detract from the message.

(d) *Followup communications.* The person named in the cease distribution and notification order or mandatory recall order shall ensure that followup communications are sent to all who fail to respond to the initial communication.

(e) *Responsibility of the recipient.* Health professionals, device user facilities, and consignees who receive a communication concerning a cease distribution and notification order or a

## § 810.16

mandatory recall order should immediately follow the instructions set forth in the communication. Where appropriate, these recipients should immediately notify their consignees of the order in accordance with paragraphs (b) and (c) of this section.

### **§ 810.16 Cease distribution and notification or mandatory recall order status reports.**

(a) The person named in a cease distribution and notification order issued under § 810.10 or a mandatory recall order issued under § 810.13 shall submit periodic status reports to FDA to enable the agency to assess the person's progress in complying with the order. The frequency of such reports and the agency official to whom such reports shall be submitted will be specified in the order.

(b) Unless otherwise specified in the order, each status report shall contain the following information:

(1) The number and type of health professionals, device user facilities, consignees, or individuals notified about the order and the date and method of notification;

(2) The number and type of health professionals, device user facilities, consignees, or individuals who have responded to the communication and the quantity of the device on hand at these locations at the time they received the communication;

(3) The number and type of health professionals, device user facilities, consignees, or individuals who have not responded to the communication;

(4) The number of devices returned or corrected by each health professional, device user facility, consignee, or individual contacted, and the quantity of products accounted for;

(5) The number and results of effectiveness checks that have been made; and

(6) Estimated timeframes for completion of the requirements of the cease distribution and notification order or mandatory recall order.

(c) The person named in the cease distribution and notification order or recall order may discontinue the submission of status reports when the agency terminates the order in accordance with § 810.17.

## 21 CFR Ch. I (4–1–20 Edition)

### **§ 810.17 Termination of a cease distribution and notification or mandatory recall order.**

(a) The person named in a cease distribution and notification order issued under § 810.10 or a mandatory recall order issued under § 810.13 may request termination of the order by submitting a written request to FDA. The person submitting a request shall certify that he or she has complied in full with all of the requirements of the order and shall include a copy of the most current status report submitted to the agency under § 810.16. A request for termination of a recall order shall include a description of the disposition of the recalled device.

(b) FDA may terminate a cease distribution and notification order issued under § 810.10 or a mandatory recall order issued under § 810.13 when the agency determines that the person named in the order:

(1) Has taken all reasonable efforts to ensure and to verify that all health professionals, device user facilities, consignees, and, where appropriate, individuals have been notified of the cease distribution and notification order, and to verify that they have been instructed to cease use of the device and to take other appropriate action; or

(2) Has removed the device from the market or has corrected the device so that use of the device would not cause serious, adverse health consequences or death.

(c) FDA will provide written notification to the person named in the order when a request for termination of a cease distribution and notification order or a mandatory recall order has been granted or denied. FDA will respond to a written request for termination of a cease distribution and notification or recall order within 30 working days of its receipt.

### **§ 810.18 Public notice.**

The agency will make available to the public in the weekly FDA Enforcement Report a descriptive listing of each new mandatory recall issued under § 810.13. The agency will delay public notification of orders when the

## Food and Drug Administration, HHS

## § 812.1

agency determines that such notification may cause unnecessary and harmful anxiety in individuals and that initial consultation between individuals and their health professionals is essential.

### PART 812—INVESTIGATIONAL DEVICE EXEMPTIONS

#### Subpart A—General Provisions

- Sec.
- 812.1 Scope.
  - 812.2 Applicability.
  - 812.3 Definitions.
  - 812.5 Labeling of investigational devices.
  - 812.7 Prohibition of promotion and other practices.
  - 812.10 Waivers.
  - 812.18 Import and export requirements.
  - 812.19 Address for IDE correspondence.

#### Subpart B—Application and Administrative Action

- 812.20 Application.
- 812.25 Investigational plan.
- 812.27 Report of prior investigations.
- 812.28 xxx
- 812.30 FDA action on applications.
- 812.35 Supplemental applications.
- 812.36 Treatment use of an investigational device.
- 812.38 Confidentiality of data and information.

#### Subpart C—Responsibilities of Sponsors

- 812.40 General responsibilities of sponsors.
- 812.42 FDA and IRB approval.
- 812.43 Selecting investigators and monitors.
- 812.45 Informing investigators.
- 812.46 Monitoring investigations.
- 812.47 Emergency research under § 50.24 of this chapter.

#### Subpart D—IRB Review and Approval

- 812.60 IRB composition, duties, and functions.
- 812.62 IRB approval.
- 812.64 IRB's continuing review.
- 812.65 [Reserved]
- 812.66 Significant risk device determinations.

#### Subpart E—Responsibilities of Investigators

- 812.100 General responsibilities of investigators.
- 812.110 Specific responsibilities of investigators.
- 812.119 Disqualification of a clinical investigator.

#### Subpart F [Reserved]

#### Subpart G—Records and Reports

- 812.140 Records.
- 812.145 Inspections.
- 812.150 Reports.

AUTHORITY: 21 U.S.C. 331, 351, 352, 353, 355, 360, 360c–360f, 360h–360j, 360bbb–8b, 371, 372, 374, 379e, 379k–1, 381, 382, 383; 42 U.S.C. 216, 241, 262, 263b–263n.

SOURCE: 45 FR 3751, Jan. 18, 1980, unless otherwise noted.

#### Subpart A—General Provisions

##### § 812.1 Scope.

(a) The purpose of this part is to encourage, to the extent consistent with the protection of public health and safety and with ethical standards, the discovery and development of useful devices intended for human use, and to that end to maintain optimum freedom for scientific investigators in their pursuit of this purpose. This part provides procedures for the conduct of clinical investigations of devices. An approved investigational device exemption (IDE) permits a device that otherwise would be required to comply with a performance standard or to have premarket approval to be shipped lawfully for the purpose of conducting investigations of that device. An IDE approved under § 812.30 or considered approved under § 812.2(b) exempts a device from the requirements of the following sections of the Federal Food, Drug, and Cosmetic Act (the act) and regulations issued thereunder: Misbranding under section 502 of the act, registration, listing, and premarket notification under section 510, performance standards under section 514, premarket approval under section 515, a banned device regulation under section 516, records and reports under section 519, restricted device requirements under section 520(e), good manufacturing practice requirements under section 520(f) except for the requirements found in § 820.30, if applicable (unless the sponsor states an intention to comply with these requirements under § 812.20(b)(3) or § 812.140(b)(4)(v)) and color additive requirements under section 721.

(b) References in this part to regulatory sections of the Code of Federal

## § 812.2

## 21 CFR Ch. I (4–1–20 Edition)

Regulations are to chapter I of title 21, unless otherwise noted.

[45 FR 3751, Jan. 18, 1980, as amended at 59 FR 14366, Mar. 28, 1994; 61 FR 52654, Oct. 7, 1996]

### § 812.2 Applicability.

(a) *General.* This part applies to all clinical investigations of devices to determine safety and effectiveness, except as provided in paragraph (c) of this section.

(b) *Abbreviated requirements.* The following categories of investigations are considered to have approved applications for IDE's, unless FDA has notified a sponsor under § 812.20(a) that approval of an application is required:

(1) An investigation of a device other than a significant risk device, if the device is not a banned device and the sponsor:

(i) Labels the device in accordance with § 812.5;

(ii) Obtains IRB approval of the investigation after presenting the reviewing IRB with a brief explanation of why the device is not a significant risk device, and maintains such approval;

(iii) Ensures that each investigator participating in an investigation of the device obtains from each subject under the investigator's care, informed consent under part 50 and documents it, unless documentation is waived by an IRB under § 56.109(c).

(iv) Complies with the requirements of § 812.46 with respect to monitoring investigations;

(v) Maintains the records required under § 812.140(b) (4) and (5) and makes the reports required under § 812.150(b) (1) through (3) and (5) through (10);

(vi) Ensures that participating investigators maintain the records required by § 812.140(a)(3)(i) and make the reports required under § 812.150(a) (1), (2), (5), and (7); and

(vii) Complies with the prohibitions in § 812.7 against promotion and other practices.

(2) An investigation of a device other than one subject to paragraph (e) of this section, if the investigation was begun on or before July 16, 1980, and to be completed, and is completed, on or before January 19, 1981.

(c) *Exempted investigations.* This part, with the exception of § 812.119, does not

apply to investigations of the following categories of devices:

(1) A device, other than a transitional device, in commercial distribution immediately before May 28, 1976, when used or investigated in accordance with the indications in labeling in effect at that time.

(2) A device, other than a transitional device, introduced into commercial distribution on or after May 28, 1976, that FDA has determined to be substantially equivalent to a device in commercial distribution immediately before May 28, 1976, and that is used or investigated in accordance with the indications in the labeling FDA reviewed under subpart E of part 807 in determining substantial equivalence.

(3) A diagnostic device, if the sponsor complies with applicable requirements in § 809.10(c) and if the testing:

(i) Is noninvasive,

(ii) Does not require an invasive sampling procedure that presents significant risk,

(iii) Does not by design or intention introduce energy into a subject, and

(iv) Is not used as a diagnostic procedure without confirmation of the diagnosis by another, medically established diagnostic product or procedure.

(4) A device undergoing consumer preference testing, testing of a modification, or testing of a combination of two or more devices in commercial distribution, if the testing is not for the purpose of determining safety or effectiveness and does not put subjects at risk.

(5) A device intended solely for veterinary use.

(6) A device shipped solely for research on or with laboratory animals and labeled in accordance with § 812.5(c).

(7) A custom device as defined in § 812.3(b), unless the device is being used to determine safety or effectiveness for commercial distribution.

(d) *Limit on certain exemptions.* In the case of class II or class III device described in paragraph (c)(1) or (2) of this section, this part applies beginning on

the date stipulated in an FDA regulation or order that calls for the submission of premarket approval applications for an unapproved class III device, or establishes a performance standard for a class II device.

(e) *Investigations subject to IND's.* A sponsor that, on July 16, 1980, has an effective investigational new drug application (IND) for an investigation of a device shall continue to comply with the requirements of part 312 until 90 days after that date. To continue the investigation after that date, a sponsor shall comply with paragraph (b)(1) of this section, if the device is not a significant risk device, or shall have obtained FDA approval under §812.30 of an IDE application for the investigation of the device.

[45 FR 3751, Jan. 18, 1980, as amended at 46 FR 8956, Jan. 27, 1981; 46 FR 14340, Feb. 27, 1981; 53 FR 11252, Apr. 6, 1988; 62 FR 4165, Jan. 29, 1997; 62 FR 12096, Mar. 14, 1997]

### §812.3 Definitions.

(a) *Act* means the Federal Food, Drug, and Cosmetic Act (sections 201–901, 52 Stat. 1040 *et seq.*, as amended (21 U.S.C. 301–392)).

(b) A custom device means a device within the meaning of section 520(b) of the Federal Food, Drug, and Cosmetic Act.

(c) *FDA* means the Food and Drug Administration.

(d) *Implant* means a device that is placed into a surgically or naturally formed cavity of the human body if it is intended to remain there for a period of 30 days or more. FDA may, in order to protect public health, determine that devices placed in subjects for shorter periods are also “implants” for purposes of this part.

(e) *Institution* means a person, other than an individual, who engages in the conduct of research on subjects or in the delivery of medical services to individuals as a primary activity or as an adjunct to providing residential or custodial care to humans. The term includes, for example, a hospital, retirement home, confinement facility, academic establishment, and device manufacturer. The term has the same meaning as “facility” in section 520(g) of the act.

(f) *Institutional review board* (IRB) means any board, committee, or other group formally designated by an institution to review biomedical research involving subjects and established, operated, and functioning in conformance with part 56. The term has the same meaning as “institutional review committee” in section 520(g) of the act.

(g) *Investigational device* means a device, including a transitional device, that is the object of an investigation.

(h) *Investigation* means a clinical investigation or research involving one or more subjects to determine the safety or effectiveness of a device.

(i) *Investigator* means an individual who actually conducts a clinical investigation, i.e., under whose immediate direction the test article is administered or dispensed to, or used involving, a subject, or, in the event of an investigation conducted by a team of individuals, is the responsible leader of that team.

(j) *Monitor*, when used as a noun, means an individual designated by a sponsor or contract research organization to oversee the progress of an investigation. The monitor may be an employee of a sponsor or a consultant to the sponsor, or an employee of or consultant to a contract research organization. *Monitor*, when used as a verb, means to oversee an investigation.

(k) *Noninvasive*, when applied to a diagnostic device or procedure, means one that does not by design or intention: (1) Penetrate or pierce the skin or mucous membranes of the body, the ocular cavity, or the urethra, or (2) enter the ear beyond the external auditory canal, the nose beyond the nares, the mouth beyond the pharynx, the anal canal beyond the rectum, or the vagina beyond the cervical os. For purposes of this part, blood sampling that involves simple venipuncture is considered noninvasive, and the use of surplus samples of body fluids or tissues that are left over from samples taken for noninvestigational purposes is also considered noninvasive.

(l) *Person* includes any individual, partnership, corporation, association, scientific or academic establishment, Government agency or organizational unit of a Government agency, and any other legal entity.

## §812.5

## 21 CFR Ch. I (4–1–20 Edition)

(m) *Significant risk device* means an investigational device that:

(1) Is intended as an implant and presents a potential for serious risk to the health, safety, or welfare of a subject;

(2) Is purported or represented to be for a use in supporting or sustaining human life and presents a potential for serious risk to the health, safety, or welfare of a subject;

(3) Is for a use of substantial importance in diagnosing, curing, mitigating, or treating disease, or otherwise preventing impairment of human health and presents a potential for serious risk to the health, safety, or welfare of a subject; or

(4) Otherwise presents a potential for serious risk to the health, safety, or welfare of a subject.

(n) *Sponsor* means a person who initiates, but who does not actually conduct, the investigation, that is, the investigational device is administered, dispensed, or used under the immediate direction of another individual. A person other than an individual that uses one or more of its own employees to conduct an investigation that it has initiated is a sponsor, not a sponsor-investigator, and the employees are investigators.

(o) *Sponsor-investigator* means an individual who both initiates and actually conducts, alone or with others, an investigation, that is, under whose immediate direction the investigational device is administered, dispensed, or used. The term does not include any person other than an individual. The obligations of a sponsor-investigator under this part include those of an investigator and those of a sponsor.

(p) *Subject* means a human who participates in an investigation, either as an individual on whom or on whose specimen an investigational device is used or as a control. A subject may be in normal health or may have a medical condition or disease.

(q) *Termination* means a discontinuance, by sponsor or by withdrawal of IRB or FDA approval, of an investigation before completion.

(r) *Transitional device* means a device subject to section 520(l) of the act, that is, a device that FDA considered to be a new drug or an antibiotic drug before May 28, 1976.

(s) *Unanticipated adverse device effect* means any serious adverse effect on health or safety or any life-threatening problem or death caused by, or associated with, a device, if that effect, problem, or death was not previously identified in nature, severity, or degree of incidence in the investigational plan or application (including a supplementary plan or application), or any other unanticipated serious problem associated with a device that relates to the rights, safety, or welfare of subjects.

(t) *Independent ethics committee (IEC)* means an independent review panel that is responsible for ensuring the protection of the rights, safety, and well-being of subjects involved in a clinical investigation and is adequately constituted to ensure that protection. An institutional review board (IRB), as defined in paragraph (f) of this section and subject to the requirements of part 56 of this chapter, is one type of IEC.

[45 FR 3751, Jan. 18, 1980, as amended at 46 FR 8956, Jan. 27, 1981; 48 FR 15622, Apr. 12, 1983; 81 FR 70340, Oct. 12, 2016; 83 FR 7385, Feb. 21, 2018; 83 FR 7385, Feb. 21, 2018]

### §812.5 Labeling of investigational devices.

(a) *Contents.* An investigational device or its immediate package shall bear a label with the following information: the name and place of business of the manufacturer, packer, or distributor (in accordance with §801.1), the quantity of contents, if appropriate, and the following statement: “CAUTION—Investigational device. Limited by Federal (or United States) law to investigational use.” The label or other labeling shall describe all relevant contraindications, hazards, adverse effects, interfering substances or devices, warnings, and precautions.

(b) *Prohibitions.* The labeling of an investigational device shall not bear any statement that is false or misleading in any particular and shall not represent that the device is safe or effective for the purposes for which it is being investigated.

(c) *Animal research.* An investigational device shipped solely for research on or with laboratory animals shall bear on its label the following statement: “CAUTION—Device for investigational use in laboratory animals

## Food and Drug Administration, HHS

## § 812.19

or other tests that do not involve human subjects.’’

(d) The appropriate FDA Center Director, according to the procedures set forth in § 801.128 or § 809.11 of this chapter, may grant an exception or alternative to the provisions in paragraphs (a) and (c) of this section, to the extent that these provisions are not explicitly required by statute, for specified lots, batches, or other units of a device that are or will be included in the Strategic National Stockpile.

[45 FR 3751, Jan. 18, 1980, as amended at 45 FR 58842, Sept. 5, 1980; 72 FR 73602, Dec. 28, 2007]

### § 812.7 Prohibition of promotion and other practices.

A sponsor, investigator, or any person acting for or on behalf of a sponsor or investigator shall not:

(a) Promote or test market an investigational device, until after FDA has approved the device for commercial distribution.

(b) Commercialize an investigational device by charging the subjects or investigators for a device a price larger than that necessary to recover costs of manufacture, research, development, and handling.

(c) Unduly prolong an investigation. If data developed by the investigation indicate in the case of a class III device that premarket approval cannot be justified or in the case of a class II device that it will not comply with an applicable performance standard or an amendment to that standard, the sponsor shall promptly terminate the investigation.

(d) Represent that an investigational device is safe or effective for the purposes for which it is being investigated.

### § 812.10 Waivers.

(a) *Request.* A sponsor may request FDA to waive any requirement of this part. A waiver request, with supporting documentation, may be submitted separately or as part of an application to the address in § 812.19.

(b) *FDA action.* FDA may by letter grant a waiver of any requirement that FDA finds is not required by the act and is unnecessary to protect the rights, safety, or welfare of human subjects.

(c) *Effect of request.* Any requirement shall continue to apply unless and until FDA waives it.

### § 812.18 Import and export requirements.

(a) *Imports.* In addition to complying with other requirements of this part, a person who imports or offers for importation an investigational device subject to this part shall be the agent of the foreign exporter with respect to investigations of the device and shall act as the sponsor of the clinical investigation, or ensure that another person acts as the agent of the foreign exporter and the sponsor of the investigation.

(b) *Exports.* A person exporting an investigational device subject to this part shall obtain FDA’s prior approval, as required by section 801(e) of the act or comply with section 802 of the act.

[45 FR 3751, Jan. 18, 1980, as amended at 62 FR 26229, May 13, 1997]

### § 812.19 Address for IDE correspondence.

(a) If you are sending an application, supplemental application, report, request for waiver, request for import or export approval, or other correspondence relating to matters covered by this part, you must send the submission to the appropriate address as follows:

(1) For devices regulated by the Center for Devices and Radiological Health, send it to the current address displayed on the website <https://www.fda.gov/cdrhsubmissionaddress>.

(2) For devices regulated by the Center for Biologics Evaluation and Research, send it to the current address displayed on the website <https://www.fda.gov/AboutFDA/CentersOffices/OfficeofMedicalProductsandTobacco/CBER/ucm385240.htm>.

(3) For devices regulated by the Center for Drug Evaluation and Research, send it to Central Document Control Room, Center for Drug Evaluation and Research, Food and Drug Administration, 5901-B Ammendale Rd., Beltsville, MD 20705-1266.

(b) You must state on the outside wrapper of each submission what the

## § 812.20

## 21 CFR Ch. I (4–1–20 Edition)

submission is, for example, an “IDE application,” a “supplemental IDE application,” or a “correspondence concerning an IDE (or an IDE application).”

[71 FR 42048, July 25, 2006, as amended at 75 FR 20915, Apr. 22, 2010; 80 FR 18094, Apr. 3, 2015; 84 FR 68339, Dec. 16, 2019]

### Subpart B—Application and Administrative Action

#### § 812.20 Application.

(a) *Submission.* (1) A sponsor shall submit an application to FDA if the sponsor intends to use a significant risk device in an investigation, intends to conduct an investigation that involves an exception from informed consent under § 50.24 of this chapter, or if FDA notifies the sponsor that an application is required for an investigation.

(2) A sponsor shall not begin an investigation for which FDA’s approval of an application is required until FDA has approved the application.

(3) A sponsor shall submit a signed “Application for an Investigational Device Exemption” (IDE application), together with accompanying materials in electronic format, to one of the addresses in § 812.19, and if eCopy by registered mail or by hand. Subsequent correspondence concerning an application or a supplemental application shall be submitted in electronic format and if eCopy by registered mail or by hand.

(4)(i) A sponsor shall submit a separate IDE for any clinical investigation involving an exception from informed consent under § 50.24 of this chapter. Such a clinical investigation is not permitted to proceed without the prior written authorization of FDA. FDA shall provide a written determination 30 days after FDA receives the IDE or earlier.

(ii) If the investigation involves an exception from informed consent under § 50.24 of this chapter, the sponsor shall prominently identify on the cover sheet that the investigation is subject to the requirements in § 50.24 of this chapter.

(b) *Contents.* An IDE application shall include, in the following order:

(1) The name and address of the sponsor.

(2) A complete report of prior investigations of the device and an accurate summary of those sections of the investigational plan described in § 812.25(a) through (e) or, in lieu of the summary, the complete plan. The sponsor shall submit to FDA a complete investigational plan and a complete report of prior investigations of the device if no IRB has reviewed them, if FDA has found an IRB’s review inadequate, or if FDA requests them.

(3) A description of the methods, facilities, and controls used for the manufacture, processing, packing, storage, and, where appropriate, installation of the device, in sufficient detail so that a person generally familiar with good manufacturing practices can make a knowledgeable judgment about the quality control used in the manufacture of the device.

(4) An example of the agreements to be entered into by all investigators to comply with investigator obligations under this part, and a list of the names and addresses of all investigators who have signed the agreement.

(5) A certification that all investigators who will participate in the investigation have signed the agreement, that the list of investigators includes all the investigators participating in the investigation, and that no investigators will be added to the investigation until they have signed the agreement.

(6) A list of the name, address, and chairperson of each IRB that has been or will be asked to review the investigation and a certification of the action concerning the investigation taken by each such IRB.

(7) The name and address of any institution at which a part of the investigation may be conducted that has not been identified in accordance with paragraph (b)(6) of this section.

(8) If the device is to be sold, the amount to be charged and an explanation of why sale does not constitute commercialization of the device.

(9) A claim for categorical exclusion under § 25.30 or § 25.34 or an environmental assessment under § 25.40.

(10) Copies of all labeling for the device.



(11) Copies of all forms and informational materials to be provided to subjects to obtain informed consent.

(12) Any other relevant information FDA requests for review of the application.

(c) *Additional information.* FDA may request additional information concerning an investigation or revision in the investigational plan. The sponsor may treat such a request as a disapproval of the application for purposes of requesting a hearing under part 16.

(d) *Information previously submitted.* Information previously submitted to the Center for Devices and Radiological Health, the Center for Biologics Evaluation and Research, or the Center for Drug Evaluation and Research, as applicable, in accordance with this chapter ordinarily need not be resubmitted, but may be incorporated by reference.

[45 FR 3751, Jan. 18, 1980, as amended at 46 FR 8956, Jan. 27, 1981; 50 FR 16669, Apr. 26, 1985; 53 FR 11252, Apr. 6, 1988; 61 FR 51530, Oct. 2, 1996; 62 FR 40600, July 29, 1997; 64 FR 10942, Mar. 8, 1999; 73 FR 49942, Aug. 25, 2008; 84 FR 68339, Dec. 16, 2019]

#### § 812.25 Investigational plan.

The investigational plan shall include, in the following order:

(a) *Purpose.* The name and intended use of the device and the objectives and duration of the investigation.

(b) *Protocol.* A written protocol describing the methodology to be used and an analysis of the protocol demonstrating that the investigation is scientifically sound.

(c) *Risk analysis.* A description and analysis of all increased risks to which subjects will be exposed by the investigation; the manner in which these risks will be minimized; a justification for the investigation; and a description of the patient population, including the number, age, sex, and condition.

(d) *Description of device.* A description of each important component, ingredient, property, and principle of operation of the device and of each anticipated change in the device during the course of the investigation.

(e) *Monitoring procedures.* The sponsor's written procedures for monitoring

the investigation and the name and address of any monitor.

(f) *Labeling.* Copies of all labeling for the device.

(g) *Consent materials.* Copies of all forms and informational materials to be provided to subjects to obtain informed consent.

(h) *IRB information.* A list of the names, locations, and chairpersons of all IRB's that have been or will be asked to review the investigation, and a certification of any action taken by any of those IRB's with respect to the investigation.

(i) *Other institutions.* The name and address of each institution at which a part of the investigation may be conducted that has not been identified in paragraph (h) of this section.

(j) *Additional records and reports.* A description of records and reports that will be maintained on the investigation in addition to those prescribed in subpart G.

#### § 812.27 Report of prior investigations.

(a) *General.* The report of prior investigations shall include reports of all prior clinical, animal, and laboratory testing of the device and shall be comprehensive and adequate to justify the proposed investigation.

(b) *Specific contents.* The report also shall include:

(1) A bibliography of all publications, whether adverse or supportive, that are relevant to an evaluation of the safety or effectiveness of the device, copies of all published and unpublished adverse information, and, if requested by an IRB or FDA, copies of other significant publications.

(2) A summary of all other unpublished information (whether adverse or supportive) in the possession of, or reasonably obtainable by, the sponsor that is relevant to an evaluation of the safety or effectiveness of the device.

(3) If information on nonclinical laboratory studies is provided, a statement that all such studies have been conducted in compliance with applicable requirements in the good laboratory practice regulations in part 58, or if any such study was not conducted in compliance with such regulations, a brief statement of the reason for the noncompliance. Failure or inability to

## § 812.28

## 21 CFR Ch. I (4–1–20 Edition)

comply with this requirement does not justify failure to provide information on a relevant nonclinical test study.

(4)(i) If data from clinical investigations conducted in the United States are provided, a statement that each investigation was conducted in compliance with applicable requirements in the protection of human subjects regulations in part 50 of this chapter, the institutional review boards regulations in part 56 of this chapter, or was not subject to the regulations under § 56.104 or § 56.105, and the investigational device exemptions regulations in this part, or if any such investigation was not conducted in compliance with those regulations, a brief statement of the reason for the noncompliance. Failure or inability to comply with these requirements does not justify failure to provide information on a relevant clinical investigation.

(ii) If data from clinical investigations conducted outside the United States are provided to support the IDE, the requirements under § 812.28 apply. If any such investigation was not conducted in accordance with good clinical practice (GCP) as described in § 812.28(a), the report of prior investigations shall include either a waiver request in accordance with § 812.28(c) or a brief statement of the reason for not conducting the investigation in accordance with GCP and a description of steps taken to ensure that the data and results are credible and accurate and that the rights, safety, and well-being of subjects have been adequately protected. Failure or inability to comply with these requirements does not justify failure to provide information on a relevant clinical investigation.

[45 FR 3751, Jan. 18, 1980, as amended at 50 FR 7518, Feb. 22, 1985; 83 FR 7385, Feb. 21, 2018]

### **§ 812.28 Acceptance of data from clinical investigations conducted outside the United States.**

(a) *Acceptance of data from clinical investigations conducted outside the United States to support an IDE or a device marketing application or submission (an application under section 515 or 520(m) of the Federal Food, Drug, and Cosmetic Act, a premarket notification submission under section 510(k) of the Federal Food,*

*Drug, and Cosmetic Act, or a request for De Novo classification under section 513(f)(2) of the Federal Food, Drug, and Cosmetic Act).* FDA will accept information on a clinical investigation conducted outside the United States to support an IDE or a device marketing application or submission if the investigation is well-designed and well-conducted and the following conditions are met:

(1) A statement is provided that the investigation was conducted in accordance with good clinical practice (GCP). For the purposes of this section, GCP is defined as a standard for the design, conduct, performance, monitoring, auditing, recording, analysis, and reporting of clinical investigations in a way that provides assurance that the data and results are credible and accurate and that the rights, safety, and well-being of subjects are protected. GCP includes review and approval (or provision of a favorable opinion) by an independent ethics committee (IEC) before initiating an investigation, continuing review of an ongoing investigation by an IEC, and obtaining and documenting the freely given informed consent of the subject (or a subject's legally authorized representative, if the subject is unable to provide informed consent) before initiating an investigation. GCP does not require informed consent in life-threatening situations when the IEC reviewing the investigation finds, before initiation of the investigation, that informed consent is not feasible and either that the conditions present are consistent with those described in § 50.23 or § 50.24(a) of this chapter, or that the measures described in the protocol or elsewhere will protect the rights, safety, and well-being of subjects.

(2) In addition to the information required elsewhere in parts 807, 812, and 814 of this chapter, as applicable, the information in paragraph (b) of this section is submitted, as follows:

(i) For an investigation of a significant risk device, as defined in § 812.3(m), the supporting information as described in paragraph (b) of this section is submitted.

(ii) For an investigation of a device, other than a significant risk device,

the supporting information as described in paragraphs (b)(1), (4), (5), (7) through (9), and (11) of this section is submitted, and the supporting information as described in paragraph (b)(10) of this section and the rationale for determining the investigation is of a device other than a significant risk device are made available for agency review upon request by FDA.

(iii) For a device investigation that meets the exemption criteria in §812.2(c), the supporting information as described in paragraphs (b)(1), (4), (5), (7) through (11) of this section and the rationale for determining the investigation meets the exemption criteria in §812.2(c) are made available for agency review upon request by FDA.

(3) FDA is able to validate the data from the investigation through an on-site inspection, or through other appropriate means, if the agency deems it necessary.

(b) *Supporting information.* A sponsor or applicant who submits data from a clinical investigation conducted outside the United States to support an IDE or a device marketing application or submission, in addition to information required elsewhere in parts 807, 812, and 814 of this chapter, as applicable, shall provide a description of the actions the sponsor or applicant took to ensure that the research conformed to GCP as described in paragraph (a)(1) of this section. The description is not required to duplicate information already submitted in the application or submission. Instead, the description must provide either the following information, as specified in paragraph (a)(2) of this section, or a cross-reference to another section of the application or submission where the information is located:

(1) The names of the investigators and the names and addresses of the research facilities and sites where records relating to the investigation are maintained;

(2) The investigator's qualifications;

(3) A description of the research facility(ies);

(4) A detailed summary of the protocol and results of the investigation and, should FDA request, case records maintained by the investigator or addi-

tional background data such as hospital or other institutional records;

(5) Either a statement that the device used in the investigation conducted outside the United States is identical to the device that is the subject of the submission or application, or a detailed description of the device and each important component (including all materials and specifications), ingredient, property, and principle of operation of the device used in the investigation conducted outside the United States and a comparison to the device that is the subject of the submission or application that indicates how the device used in the investigation is similar to and/or different from the device that is the subject of the submission or application;

(6) If the investigation is intended to support the safety and effectiveness of a device, a discussion demonstrating that the data and information constitute valid scientific evidence within the meaning of §860.7 of this chapter;

(7) The name and address of the IEC that reviewed the investigation and a statement that the IEC meets the definition in §812.3(t). The sponsor or applicant must maintain records supporting such statement, including records describing the qualifications of IEC members, and make these records available for agency review upon request;

(8) A summary of the IEC's decision to approve or modify and approve the investigation, or to provide a favorable opinion;

(9) A description of how informed consent was obtained;

(10) A description of what incentives, if any, were provided to subjects to participate in the investigation;

(11) A description of how the sponsor(s) monitored the investigation and ensured that the investigation was carried out consistently with the protocol; and

(12) A description of how investigators were trained to comply with GCP (as described in paragraph (a)(1) of this section) and to conduct the investigation in accordance with the protocol, and a statement on whether written

## § 812.30

## 21 CFR Ch. I (4–1–20 Edition)

commitments by investigators to comply with GCP and the protocol were obtained. Any signed written commitments by investigators must be maintained by the sponsor or applicant and made available for agency review upon request.

(c) *Waivers.* (1) A sponsor or applicant may ask FDA to waive any applicable requirements under paragraphs (a)(1) and (b) of this section. A waiver request may be submitted in an IDE or in an amendment or supplement to an IDE, in a device marketing application or submission (an application under section 515 or 520(m) of the Federal Food, Drug, and Cosmetic Act, a premarket notification submission under section 510(k) of the Federal Food, Drug, and Cosmetic Act, or a request for De Novo classification under section 513(f)(2) of the Federal Food, Drug, and Cosmetic Act) or in an amendment or supplement to a device marketing application or submission, or in a pre-submission. A waiver request is required to contain at least one of the following:

- (i) An explanation why the sponsor's or applicant's compliance with the requirement is unnecessary or cannot be achieved;
- (ii) A description of an alternative submission or course of action that satisfies the purpose of the requirement; or
- (iii) Other information justifying a waiver.

(2) FDA may grant a waiver if it finds that doing so would be in the interest of the public health.

(d) *Records.* A sponsor or applicant must retain the records required by this section for a clinical investigation conducted outside the United States as follows:

(1) If the investigation is submitted in support of an IDE, for 2 years after the termination or completion of the IDE; and

(2) If the investigation is submitted in support of a premarket approval application, a notice of completion of a product development protocol, a humanitarian device exemption application, a premarket notification submission, or a request for De Novo classification, for 2 years after an agency de-

cision on that submission or application.

(e) *Clinical investigations conducted outside of the United States that do not meet conditions.* For clinical investigations conducted outside the United States that do not meet the conditions under paragraph (a) of this section, FDA may accept the information from such clinical investigations to support an IDE or a device marketing application or submission if FDA believes that the data and results from such clinical investigation are credible and accurate and that the rights, safety, and well-being of subjects have been adequately protected.

[83 FR 7386, Feb. 21, 2018]

### § 812.30 FDA action on applications.

(a) *Approval or disapproval.* FDA will notify the sponsor in writing of the date it receives an application. FDA may approve an investigation as proposed, approve it with modifications, or disapprove it. An investigation may not begin until:

(1) Thirty days after FDA receives the application at the address in § 812.19 for the investigation of a device other than a banned device, unless FDA notifies the sponsor that the investigation may not begin; or

(2) FDA approves, by order, an IDE for the investigation.

(b) *Grounds for disapproval or withdrawal.* FDA may disapprove or withdraw approval of an application if FDA finds that:

(1) There has been a failure to comply with any requirement of this part or the act, any other applicable regulation or statute, or any condition of approval imposed by an IRB or FDA.

(2) The application or a report contains an untrue statement of a material fact, or omits material information required by this part.

(3) The sponsor fails to respond to a request for additional information within the time prescribed by FDA.

(4) There is reason to believe that the risks to the subjects are not outweighed by the anticipated benefits to the subjects and the importance of the knowledge to be gained, or informed consent is inadequate, or the investigation is scientifically unsound, or there

is reason to believe that the device as used is ineffective.

(5) It is otherwise unreasonable to begin or to continue the investigation owing to the way in which the device is used or the inadequacy of:

(i) The report of prior investigations or the investigational plan;

(ii) The methods, facilities, and controls used for the manufacturing, processing, packaging, storage, and, where appropriate, installation of the device; or

(iii) Monitoring and review of the investigation.

(c) *Notice of disapproval or withdrawal.* If FDA disapproves an application or proposes to withdraw approval of an application, FDA will notify the sponsor in writing.

(1) A disapproval order will contain a complete statement of the reasons for disapproval and a statement that the sponsor has an opportunity to request a hearing under part 16.

(2) A notice of a proposed withdrawal of approval will contain a complete statement of the reasons for withdrawal and a statement that the sponsor has an opportunity to request a hearing under part 16. FDA will provide the opportunity for hearing before withdrawal of approval, unless FDA determines in the notice that continuation of testing under the exemption will result in an unreasonable risk to the public health and orders withdrawal of approval before any hearing.

[45 FR 3751, Jan. 18, 1980, as amended at 45 FR 58842, Sept. 5, 1980]

#### § 812.35 Supplemental applications.

(a) *Changes in investigational plan*—(1) *Changes requiring prior approval.* Except as described in paragraphs (a)(2) through (a)(4) of this section, a sponsor must obtain approval of a supplemental application under § 812.30(a), and IRB approval when appropriate (see §§ 56.110 and 56.111 of this chapter), prior to implementing a change to an investigational plan. If a sponsor intends to conduct an investigation that involves an exception to informed consent under § 50.24 of this chapter, the sponsor shall submit a separate investigational device exemption (IDE) application in accordance with § 812.20(a).

(2) *Changes effected for emergency use.*

The requirements of paragraph (a)(1) of this section regarding FDA approval of a supplement do not apply in the case of a deviation from the investigational plan to protect the life or physical well-being of a subject in an emergency. Such deviation shall be reported to FDA within 5-working days after the sponsor learns of it (see § 812.150(a)(4)).

(3) *Changes effected with notice to FDA within 5 days.* A sponsor may make certain changes without prior approval of a supplemental application under paragraph (a)(1) of this section if the sponsor determines that these changes meet the criteria described in paragraphs (a)(3)(i) and (a)(3)(ii) of this section, on the basis of credible information defined in paragraph (a)(3)(iii) of this section, and the sponsor provides notice to FDA within 5-working days of making these changes.

(i) *Developmental changes.* The requirements in paragraph (a)(1) of this section regarding FDA approval of a supplement do not apply to developmental changes in the device (including manufacturing changes) that do not constitute a significant change in design or basic principles of operation and that are made in response to information gathered during the course of an investigation.

(ii) *Changes to clinical protocol.* The requirements in paragraph (a)(1) of this section regarding FDA approval of a supplement do not apply to changes to clinical protocols that do not affect:

(A) The validity of the data or information resulting from the completion of the approved protocol, or the relationship of likely patient risk to benefit relied upon to approve the protocol;

(B) The scientific soundness of the investigational plan; or

(C) The rights, safety, or welfare of the human subjects involved in the investigation.

(iii) *Definition of credible information.*

(A) Credible information to support developmental changes in the device (including manufacturing changes) includes data generated under the design control procedures of § 820.30, pre-clinical/animal testing, peer reviewed published literature, or other reliable

information such as clinical information gathered during a trial or marketing.

(B) Credible information to support changes to clinical protocols is defined as the sponsor's documentation supporting the conclusion that a change does not have a significant impact on the study design or planned statistical analysis, and that the change does not affect the rights, safety, or welfare of the subjects. Documentation shall include information such as peer reviewed published literature, the recommendation of the clinical investigator(s), and/or the data gathered during the clinical trial or marketing.

(iv) *Notice of IDE change.* Changes meeting the criteria in paragraphs (a)(3)(i) and (a)(3)(ii) of this section that are supported by credible information as defined in paragraph (a)(3)(iii) of this section may be made without prior FDA approval if the sponsor submits a notice of the change to the IDE not later than 5-working days after making the change. Changes to devices are deemed to occur on the date the device, manufactured incorporating the design or manufacturing change, is distributed to the investigator(s). Changes to a clinical protocol are deemed to occur when a clinical investigator is notified by the sponsor that the change should be implemented in the protocol or, for sponsor-investigator studies, when a sponsor-investigator incorporates the change in the protocol. Such notices shall be identified as a "notice of IDE change."

(A) For a developmental or manufacturing change to the device, the notice shall include a summary of the relevant information gathered during the course of the investigation upon which the change was based; a description of the change to the device or manufacturing process (cross-referenced to the appropriate sections of the original device description or manufacturing process); and, if design controls were used to assess the change, a statement that no new risks were identified by appropriate risk analysis and that the verification and validation testing, as appropriate, demonstrated that the design outputs met the design input requirements. If another method of assessment was used, the notice shall in-

clude a summary of the information which served as the credible information supporting the change.

(B) For a protocol change, the notice shall include a description of the change (cross-referenced to the appropriate sections of the original protocol); an assessment supporting the conclusion that the change does not have a significant impact on the study design or planned statistical analysis; and a summary of the information that served as the credible information supporting the sponsor's determination that the change does not affect the rights, safety, or welfare of the subjects.

(4) *Changes submitted in annual report.* The requirements of paragraph (a)(1) of this section do not apply to minor changes to the purpose of the study, risk analysis, monitoring procedures, labeling, informed consent materials, and IRB information that do not affect:

(i) The validity of the data or information resulting from the completion of the approved protocol, or the relationship of likely patient risk to benefit relied upon to approve the protocol;

(ii) The scientific soundness of the investigational plan; or

(iii) The rights, safety, or welfare of the human subjects involved in the investigation. Such changes shall be reported in the annual progress report for the IDE, under § 812.150(b)(5).

(b) *IRB approval for new facilities.* A sponsor shall submit to FDA a certification of any IRB approval of an investigation or a part of an investigation not included in the IDE application. If the investigation is otherwise unchanged, the supplemental application shall consist of an updating of the information required by § 812.20(b) and (c) and a description of any modifications in the investigational plan required by the IRB as a condition of approval. A certification of IRB approval need not be included in the initial submission of the supplemental application, and such certification is not a precondition for agency consideration of the application. Nevertheless, a sponsor may not begin a part of an investigation at a facility until the IRB has approved the investigation, FDA has received the certification of IRB approval, and FDA,

under § 812.30(a), has approved the supplemental application relating to that part of the investigation (see § 56.103(a)).

[50 FR 25909, June 24, 1985; 50 FR 28932, July 17, 1985, as amended at 61 FR 51531, Oct. 2, 1996; 63 FR 64625, Nov. 23, 1998]

**§ 812.36 Treatment use of an investigational device.**

(a) *General.* A device that is not approved for marketing may be under clinical investigation for a serious or immediately life-threatening disease or condition in patients for whom no comparable or satisfactory alternative device or other therapy is available. During the clinical trial or prior to final action on the marketing application, it may be appropriate to use the device in the treatment of patients not in the trial under the provisions of a treatment investigational device exemption (IDE). The purpose of this section is to facilitate the availability of promising new devices to desperately ill patients as early in the device development process as possible, before general marketing begins, and to obtain additional data on the device's safety and effectiveness. In the case of a serious disease, a device ordinarily may be made available for treatment use under this section after all clinical trials have been completed. In the case of an immediately life-threatening disease, a device may be made available for treatment use under this section prior to the completion of all clinical trials. For the purpose of this section, an "immediately life-threatening" disease means a stage of a disease in which there is a reasonable likelihood that death will occur within a matter of months or in which premature death is likely without early treatment. For purposes of this section, "treatment use" of a device includes the use of a device for diagnostic purposes.

(b) *Criteria.* FDA shall consider the use of an investigational device under a treatment IDE if:

(1) The device is intended to treat or diagnose a serious or immediately life-threatening disease or condition;

(2) There is no comparable or satisfactory alternative device or other therapy available to treat or diagnose

that stage of the disease or condition in the intended patient population;

(3) The device is under investigation in a controlled clinical trial for the same use under an approved IDE, or such clinical trials have been completed; and

(4) The sponsor of the investigation is actively pursuing marketing approval/clearance of the investigational device with due diligence.

(c) *Applications for treatment use.* (1) A treatment IDE application shall include, in the following order:

(i) The name, address, and telephone number of the sponsor of the treatment IDE;

(ii) The intended use of the device, the criteria for patient selection, and a written protocol describing the treatment use;

(iii) An explanation of the rationale for use of the device, including, as appropriate, either a list of the available regimens that ordinarily should be tried before using the investigational device or an explanation of why the use of the investigational device is preferable to the use of available marketed treatments;

(iv) A description of clinical procedures, laboratory tests, or other measures that will be used to evaluate the effects of the device and to minimize risk;

(v) Written procedures for monitoring the treatment use and the name and address of the monitor;

(vi) Instructions for use for the device and all other labeling as required under § 812.5(a) and (b);

(vii) Information that is relevant to the safety and effectiveness of the device for the intended treatment use. Information from other IDE's may be incorporated by reference to support the treatment use;

(viii) A statement of the sponsor's commitment to meet all applicable responsibilities under this part and part 56 of this chapter and to ensure compliance of all participating investigators with the informed consent requirements of part 50 of this chapter;

(ix) An example of the agreement to be signed by all investigators participating in the treatment IDE and certification that no investigator will be

## §812.36

## 21 CFR Ch. I (4-1-20 Edition)

added to the treatment IDE before the agreement is signed; and

(x) If the device is to be sold, the price to be charged and a statement indicating that the price is based on manufacturing and handling costs only.

(2) A licensed practitioner who receives an investigational device for treatment use under a treatment IDE is an “investigator” under the IDE and is responsible for meeting all applicable investigator responsibilities under this part and parts 50 and 56 of this chapter.

(d) *FDA action on treatment IDE applications*—(1) *Approval of treatment IDE’s*. Treatment use may begin 30 days after FDA receives the treatment IDE submission at the address specified in §812.19, unless FDA notifies the sponsor in writing earlier than the 30 days that the treatment use may or may not begin. FDA may approve the treatment use as proposed or approve it with modifications.

(2) *Disapproval or withdrawal of approval of treatment IDE’s*. FDA may disapprove or withdraw approval of a treatment IDE if:

(i) The criteria specified in §812.36(b) are not met or the treatment IDE does not contain the information required in §812.36(c);

(ii) FDA determines that any of the grounds for disapproval or withdrawal of approval listed in §812.30(b)(1) through (b)(5) apply;

(iii) The device is intended for a serious disease or condition and there is insufficient evidence of safety and effectiveness to support such use;

(iv) The device is intended for an immediately life-threatening disease or condition and the available scientific evidence, taken as a whole, fails to provide a reasonable basis for concluding that the device:

(A) May be effective for its intended use in its intended population; or

(B) Would not expose the patients to whom the device is to be administered to an unreasonable and significant additional risk of illness or injury;

(v) There is reasonable evidence that the treatment use is impeding enrollment in, or otherwise interfering with the conduct or completion of, a con-

trolled investigation of the same or another investigational device;

(vi) The device has received marketing approval/clearance or a comparable device or therapy becomes available to treat or diagnose the same indication in the same patient population for which the investigational device is being used;

(vii) The sponsor of the controlled clinical trial is not pursuing marketing approval/clearance with due diligence;

(viii) Approval of the IDE for the controlled clinical investigation of the device has been withdrawn; or

(ix) The clinical investigator(s) named in the treatment IDE are not qualified by reason of their scientific training and/or experience to use the investigational device for the intended treatment use.

(3) *Notice of disapproval or withdrawal*. If FDA disapproves or proposes to withdraw approval of a treatment IDE, FDA will follow the procedures set forth in §812.30(c).

(e) *Safeguards*. Treatment use of an investigational device is conditioned upon the sponsor and investigators complying with the safeguards of the IDE process and the regulations governing informed consent (part 50 of this chapter) and institutional review boards (part 56 of this chapter).

(f) *Reporting requirements*. The sponsor of a treatment IDE shall submit progress reports on a semi-annual basis to all reviewing IRB’s and FDA until the filing of a marketing application. These reports shall be based on the period of time since initial approval of the treatment IDE and shall include the number of patients treated with the device under the treatment IDE, the names of the investigators participating in the treatment IDE, and a brief description of the sponsor’s efforts to pursue marketing approval/clearance of the device. Upon filing of a marketing application, progress reports shall be submitted annually in accordance with §812.150(b)(5). The sponsor of a treatment IDE is responsible for submitting all other reports required under §812.150.

[62 FR 48947, Sept. 18, 1997]



**§ 812.38 Confidentiality of data and information.**

(a) *Existence of IDE.* FDA will not disclose the existence of an IDE unless its existence has previously been publicly disclosed or acknowledged, until FDA approves an application for premarket approval of the device subject to the IDE; or a notice of completion of a product development protocol for the device has become effective.

(b) *Availability of summaries or data.*  
(1) FDA will make publicly available, upon request, a detailed summary of information concerning the safety and effectiveness of the device that was the basis for an order approving, disapproving, or withdrawing approval of an application for an IDE for a banned device. The summary shall include information on any adverse effect on health caused by the device.

(2) If a device is a banned device or if the existence of an IDE has been publicly disclosed or acknowledged, data or information contained in the file is not available for public disclosure before approval of an application for premarket approval or the effective date of a notice of completion of a product development protocol except as provided in this section. FDA may, in its discretion, disclose a summary of selected portions of the safety and effectiveness data, that is, clinical, animal, or laboratory studies and tests of the device, for public consideration of a specific pending issue.

(3) If the existence of an IDE file has not been publicly disclosed or acknowledged, no data or information in the file are available for public disclosure except as provided in paragraphs (b)(1) and (c) of this section.

(4) Notwithstanding paragraph (b)(2) of this section, FDA will make available to the public, upon request, the information in the IDE that was required to be filed in Docket Number 95S-0158 in the Division of Dockets Management (HFA-305), Food and Drug Administration, 5630 Fishers Lane, rm. 1061, Rockville, MD 20852, for investigations involving an exception from informed consent under § 50.24 of this chapter. Persons wishing to request this information shall submit a request under the Freedom of Information Act.

(c) *Reports of adverse effects.* Upon request or on its own initiative, FDA shall disclose to an individual on whom an investigational device has been used a copy of a report of adverse device effects relating to that use.

(d) *Other rules.* Except as otherwise provided in this section, the availability for public disclosure of data and information in an IDE file shall be handled in accordance with § 814.9.

[45 FR 3751, Jan. 18, 1980, as amended at 53 FR 11253, Apr. 6, 1988; 61 FR 51531, Oct. 2, 1996]

**Subpart C—Responsibilities of Sponsors****§ 812.40 General responsibilities of sponsors.**

Sponsors are responsible for selecting qualified investigators and providing them with the information they need to conduct the investigation properly, ensuring proper monitoring of the investigation, ensuring that IRB review and approval are obtained, submitting an IDE application to FDA, and ensuring that any reviewing IRB and FDA are promptly informed of significant new information about an investigation. Additional responsibilities of sponsors are described in subparts B and G.

**§ 812.42 FDA and IRB approval.**

A sponsor shall not begin an investigation or part of an investigation until an IRB and FDA have both approved the application or supplemental application relating to the investigation or part of an investigation.

[46 FR 8957, Jan. 27, 1981]

**§ 812.43 Selecting investigators and monitors.**

(a) *Selecting investigators.* A sponsor shall select investigators qualified by training and experience to investigate the device.

(b) *Control of device.* A sponsor shall ship investigational devices only to qualified investigators participating in the investigation.

(c) *Obtaining agreements.* A sponsor shall obtain from each participating investigator a signed agreement that includes:

## § 812.45

(1) The investigator's curriculum vitae.

(2) Where applicable, a statement of the investigator's relevant experience, including the dates, location, extent, and type of experience.

(3) If the investigator was involved in an investigation or other research that was terminated, an explanation of the circumstances that led to termination.

(4) A statement of the investigator's commitment to:

(i) Conduct the investigation in accordance with the agreement, the investigational plan, this part and other applicable FDA regulations, and conditions of approval imposed by the reviewing IRB or FDA;

(ii) Supervise all testing of the device involving human subjects; and

(iii) Ensure that the requirements for obtaining informed consent are met.

(5) Sufficient accurate financial disclosure information to allow the sponsor to submit a complete and accurate certification or disclosure statement as required under part 54 of this chapter. The sponsor shall obtain a commitment from the clinical investigator to promptly update this information if any relevant changes occur during the course of the investigation and for 1 year following completion of the study. This information shall not be submitted in an investigational device exemption application, but shall be submitted in any marketing application involving the device.

(d) *Selecting monitors.* A sponsor shall select monitors qualified by training and experience to monitor the investigational study in accordance with this part and other applicable FDA regulations.

[45 FR 3751, Jan. 18, 1980, as amended at 63 FR 5253, Feb. 2, 1998]

### § 812.45 Informing investigators.

A sponsor shall supply all investigators participating in the investigation with copies of the investigational plan and the report of prior investigations of the device.

### § 812.46 Monitoring investigations.

(a) *Securing compliance.* A sponsor who discovers that an investigator is not complying with the signed agreement, the investigational plan, the re-

## 21 CFR Ch. I (4-1-20 Edition)

quirements of this part or other applicable FDA regulations, or any conditions of approval imposed by the reviewing IRB or FDA shall promptly either secure compliance, or discontinue shipments of the device to the investigator and terminate the investigator's participation in the investigation. A sponsor shall also require such an investigator to dispose of or return the device, unless this action would jeopardize the rights, safety, or welfare of a subject.

(b) *Unanticipated adverse device effects.*

(1) A sponsor shall immediately conduct an evaluation of any unanticipated adverse device effect.

(2) A sponsor who determines that an unanticipated adverse device effect presents an unreasonable risk to subjects shall terminate all investigations or parts of investigations presenting that risk as soon as possible. Termination shall occur not later than 5 working days after the sponsor makes this determination and not later than 15 working days after the sponsor first received notice of the effect.

(c) *Resumption of terminated studies.* If the device is a significant risk device, a sponsor may not resume a terminated investigation without IRB and FDA approval. If the device is not a significant risk device, a sponsor may not resume a terminated investigation without IRB approval and, if the investigation was terminated under paragraph (b)(2) of this section, FDA approval.

### § 812.47 Emergency research under § 50.24 of this chapter.

(a) The sponsor shall monitor the progress of all investigations involving an exception from informed consent under § 50.24 of this chapter. When the sponsor receives from the IRB information concerning the public disclosures under § 50.24(a)(7)(ii) and (a)(7)(iii) of this chapter, the sponsor shall promptly submit to the IDE file and to Docket Number 95S-0158 in the Division of Dockets Management (HFA-305), Food and Drug Administration, 5630 Fishers Lane, rm. 1061, Rockville, MD 20852, copies of the information that was disclosed, identified by the IDE number.

(b) The sponsor also shall monitor such investigations to determine when

an IRB determines that it cannot approve the research because it does not meet the criteria in the exception in § 50.24(a) of this chapter or because of other relevant ethical concerns. The sponsor promptly shall provide this information in writing to FDA, investigators who are asked to participate in this or a substantially equivalent clinical investigation, and other IRB's that are asked to review this or a substantially equivalent investigation.

[61 FR 51531, Oct. 2, 1996, as amended at 64 FR 10943, Mar. 8, 1999]

### Subpart D—IRB Review and Approval

#### § 812.60 IRB composition, duties, and functions.

An IRB reviewing and approving investigations under this part shall comply with the requirements of part 56 in all respects, including its composition, duties, and functions.

[46 FR 8957, Jan. 27, 1981]

#### § 812.62 IRB approval.

(a) An IRB shall review and have authority to approve, require modifications in (to secure approval), or disapprove all investigations covered by this part.

(b) If no IRB exists or if FDA finds that an IRB's review is inadequate, a sponsor may submit an application to FDA.

[46 FR 8957, Jan. 27, 1981]

#### § 812.64 IRB's continuing review.

The IRB shall conduct its continuing review of an investigation in accordance with part 56.

[46 FR 8957, Jan. 27, 1981]

#### § 812.65 [Reserved]

#### § 812.66 Significant risk device determinations.

If an IRB determines that an investigation, presented for approval under § 812.2(b)(1)(ii), involves a significant risk device, it shall so notify the investigator and, where appropriate, the sponsor. A sponsor may not begin the

investigation except as provided in § 812.30(a).

[46 FR 8957, Jan. 27, 1981]

### Subpart E—Responsibilities of Investigators

#### § 812.100 General responsibilities of investigators.

An investigator is responsible for ensuring that an investigation is conducted according to the signed agreement, the investigational plan and applicable FDA regulations, for protecting the rights, safety, and welfare of subjects under the investigator's care, and for the control of devices under investigation. An investigator also is responsible for ensuring that informed consent is obtained in accordance with part 50 of this chapter. Additional responsibilities of investigators are described in subpart G.

[45 FR 3751, Jan. 18, 1980, as amended at 46 FR 8957, Jan. 27, 1981]

#### § 812.110 Specific responsibilities of investigators.

(a) *Awaiting approval.* An investigator may determine whether potential subjects would be interested in participating in an investigation, but shall not request the written informed consent of any subject to participate, and shall not allow any subject to participate before obtaining IRB and FDA approval.

(b) *Compliance.* An investigator shall conduct an investigation in accordance with the signed agreement with the sponsor, the investigational plan, this part and other applicable FDA regulations, and any conditions of approval imposed by an IRB or FDA.

(c) *Supervising device use.* An investigator shall permit an investigational device to be used only with subjects under the investigator's supervision. An investigator shall not supply an investigational device to any person not authorized under this part to receive it.

(d) *Financial disclosure.* A clinical investigator shall disclose to the sponsor sufficient accurate financial information to allow the applicant to submit complete and accurate certification or disclosure statements required under

part 54 of this chapter. The investigator shall promptly update this information if any relevant changes occur during the course of the investigation and for 1 year following completion of the study.

(e) *Disposing of device.* Upon completion or termination of a clinical investigation or the investigator's part of an investigation, or at the sponsor's request, an investigator shall return to the sponsor any remaining supply of the device or otherwise dispose of the device as the sponsor directs.

[45 FR 3751, Jan. 18, 1980, as amended at 63 FR 5253, Feb. 2, 1998]

**§812.119 Disqualification of a clinical investigator.**

(a) If FDA has information indicating that an investigator (including a sponsor-investigator) has repeatedly or deliberately failed to comply with the requirements of this part, part 50, or part 56 of this chapter, or has repeatedly or deliberately submitted to FDA or to the sponsor false information in any required report, the Center for Devices and Radiological Health, the Center for Biologics Evaluation and Research, or the Center for Drug Evaluation and Research will furnish the investigator written notice of the matter complained of and offer the investigator an opportunity to explain the matter in writing, or, at the option of the investigator, in an informal conference. If an explanation is offered and accepted by the applicable Center, the Center will discontinue the disqualification proceeding. If an explanation is offered but not accepted by the applicable Center, the investigator will be given an opportunity for a regulatory hearing under part 16 of this chapter on the question of whether the investigator is eligible to receive test articles under this part and eligible to conduct any clinical investigation that supports an application for a research or marketing permit for products regulated by FDA.

(b) After evaluating all available information, including any explanation presented by the investigator, if the Commissioner determines that the investigator has repeatedly or deliberately failed to comply with the requirements of this part, part 50, or part 56 of this chapter, or has repeatedly or

deliberately submitted to FDA or to the sponsor false information in any required report, the Commissioner will notify the investigator, the sponsor of any investigation in which the investigator has been named as a participant, and the reviewing investigational review boards (IRBs) that the investigator is not eligible to receive test articles under this part. The notification to the investigator, sponsor and IRBs will provide a statement of the basis for such determination. The notification also will explain that an investigator determined to be ineligible to receive test articles under this part will be ineligible to conduct any clinical investigation that supports an application for a research or marketing permit for products regulated by FDA, including drugs, biologics, devices, new animal drugs, foods, including dietary supplements, that bear a nutrient content claim or a health claim, infant formulas, food and color additives, and tobacco products.

(c) Each application or submission to FDA under the provisions of this chapter containing data reported by an investigator who has been determined to be ineligible to receive FDA-regulated test articles is subject to examination to determine whether the investigator has submitted unreliable data that are essential to the continuation of an investigation or essential to the clearance or approval of a marketing application, or essential to the continued marketing of an FDA-regulated product.

(d) If the Commissioner determines, after the unreliable data submitted by the investigator are eliminated from consideration, that the data remaining are inadequate to support a conclusion that it is reasonably safe to continue the investigation, the Commissioner will notify the sponsor, who shall have an opportunity for a regulatory hearing under part 16 of this chapter. If a danger to the public health exists, however, the Commissioner shall terminate the investigational device exemption (IDE) immediately and notify the sponsor and the reviewing IRBs of the termination. In such case, the sponsor shall have an opportunity for a regulatory hearing before FDA under part 16 of this chapter on the question of

whether the IDE should be reinstated. The determination that an investigation may not be considered in support of a research or marketing application or a notification or petition submission does not, however, relieve the sponsor of any obligation under any other applicable regulation to submit to FDA the results of the investigation.

(e) If the Commissioner determines, after the unreliable data submitted by the investigator are eliminated from consideration, that the continued clearance or approval of the product for which the data were submitted cannot be justified, the Commissioner will proceed to rescind clearance or withdraw approval of the product in accordance with the applicable provisions of the relevant statutes.

(f) An investigator who has been determined to be ineligible under paragraph (b) of this section may be reinstated as eligible when the Commissioner determines that the investigator has presented adequate assurances that the investigator will employ all test articles, and will conduct any clinical investigation that supports an application for a research or marketing permit for products regulated by FDA, solely in compliance with the applicable provisions of this chapter.

[77 FR 25360, Apr. 30, 2012]

### Subpart F [Reserved]

### Subpart G—Records and Reports

#### § 812.140 Records.

(a) *Investigator records.* A participating investigator shall maintain the following accurate, complete, and current records relating to the investigator's participation in an investigation:

(1) All correspondence with another investigator, an IRB, the sponsor, a monitor, or FDA, including required reports.

(2) Records of receipt, use or disposition of a device that relate to:

(i) The type and quantity of the device, the dates of its receipt, and the batch number or code mark.

(ii) The names of all persons who received, used, or disposed of each device.

(iii) Why and how many units of the device have been returned to the sponsor, repaired, or otherwise disposed of.

(3) Records of each subject's case history and exposure to the device. Case histories include the case report forms and supporting data including, for example, signed and dated consent forms and medical records including, for example, progress notes of the physician, the individual's hospital chart(s), and the nurses' notes. Such records shall include:

(i) Documents evidencing informed consent and, for any use of a device by the investigator without informed consent, any written concurrence of a licensed physician and a brief description of the circumstances justifying the failure to obtain informed consent. The case history for each individual shall document that informed consent was obtained prior to participation in the study.

(ii) All relevant observations, including records concerning adverse device effects (whether anticipated or unanticipated), information and data on the condition of each subject upon entering, and during the course of, the investigation, including information about relevant previous medical history and the results of all diagnostic tests.

(iii) A record of the exposure of each subject to the investigational device, including the date and time of each use, and any other therapy.

(4) The protocol, with documents showing the dates of and reasons for each deviation from the protocol.

(5) Any other records that FDA requires to be maintained by regulation or by specific requirement for a category of investigations or a particular investigation.

(b) *Sponsor records.* A sponsor shall maintain the following accurate, complete, and current records relating to an investigation:

(1) All correspondence with another sponsor, a monitor, an investigator, an IRB, or FDA, including required reports.

(2) Records of shipment and disposition. Records of shipment shall include the name and address of the consignee, type and quantity of device, date of shipment, and batch number or code

## §812.145

## 21 CFR Ch. I (4–1–20 Edition)

mark. Records of disposition shall describe the batch number or code marks of any devices returned to the sponsor, repaired, or disposed of in other ways by the investigator or another person, and the reasons for and method of disposal.

(3) Signed investigator agreements including the financial disclosure information required to be collected under §812.43(c)(5) in accordance with part 54 of this chapter.

(4) For each investigation subject to §812.2(b)(1) of a device other than a significant risk device, the records described in paragraph (b)(5) of this section and the following records, consolidated in one location and available for FDA inspection and copying:

(i) The name and intended use of the device and the objectives of the investigation;

(ii) A brief explanation of why the device is not a significant risk device;

(iii) The name and address of each investigator;

(iv) The name and address of each IRB that has reviewed the investigation;

(v) A statement of the extent to which the good manufacturing practice regulation in part 820 will be followed in manufacturing the device; and

(vi) Any other information required by FDA.

(5) Records concerning adverse device effects (whether anticipated or unanticipated) and complaints and

(6) Any other records that FDA requires to be maintained by regulation or by specific requirement for a category of investigation or a particular investigation.

(c) *IRB records.* An IRB shall maintain records in accordance with part 56 of this chapter.

(d) *Retention period.* An investigator or sponsor shall maintain the records required by this subpart during the investigation and for a period of 2 years after the latter of the following two dates: The date on which the investigation is terminated or completed, or the date that the records are no longer required for purposes of supporting a premarket approval application, a notice of completion of a product development protocol, a humanitarian device exemption application, a premarket

notification submission, or a request for De Novo classification.

(e) *Records custody.* An investigator or sponsor may withdraw from the responsibility to maintain records for the period required in paragraph (d) of this section and transfer custody of the records to any other person who will accept responsibility for them under this part, including the requirements of §812.145. Notice of a transfer shall be given to FDA not later than 10 working days after transfer occurs.

[45 FR 3751, Jan. 18, 1980, as amended at 45 FR 58843, Sept. 5, 1980; 46 FR 8957, Jan. 27, 1981; 61 FR 57280, Nov. 5, 1996; 63 FR 5253, Feb. 2, 1998; 83 FR 7387, Feb. 21, 2018; 83 FR 7387, Feb. 21, 2018]

### §812.145 Inspections.

(a) *Entry and inspection.* A sponsor or an investigator who has authority to grant access shall permit authorized FDA employees, at reasonable times and in a reasonable manner, to enter and inspect any establishment where devices are held (including any establishment where devices are manufactured, processed, packed, installed, used, or implanted or where records of results from use of devices are kept).

(b) *Records inspection.* A sponsor, IRB, or investigator, or any other person acting on behalf of such a person with respect to an investigation, shall permit authorized FDA employees, at reasonable times and in a reasonable manner, to inspect and copy all records relating to an investigation.

(c) *Records identifying subjects.* An investigator shall permit authorized FDA employees to inspect and copy records that identify subjects, upon notice that FDA has reason to suspect that adequate informed consent was not obtained, or that reports required to be submitted by the investigator to the sponsor or IRB have not been submitted or are incomplete, inaccurate, false, or misleading.

### §812.150 Reports.

(a) *Investigator reports.* An investigator shall prepare and submit the following complete, accurate, and timely reports:

(1) *Unanticipated adverse device effects.* An investigator shall submit to the

sponsor and to the reviewing IRB a report of any unanticipated adverse device effect occurring during an investigation as soon as possible, but in no event later than 10 working days after the investigator first learns of the effect.

(2) *Withdrawal of IRB approval.* An investigator shall report to the sponsor, within 5 working days, a withdrawal of approval by the reviewing IRB of the investigator's part of an investigation.

(3) *Progress.* An investigator shall submit progress reports on the investigation to the sponsor, the monitor, and the reviewing IRB at regular intervals, but in no event less often than yearly.

(4) *Deviations from the investigational plan.* An investigator shall notify the sponsor and the reviewing IRB (see § 56.108(a) (3) and (4)) of any deviation from the investigational plan to protect the life or physical well-being of a subject in an emergency. Such notice shall be given as soon as possible, but in no event later than 5 working days after the emergency occurred. Except in such an emergency, prior approval by the sponsor is required for changes in or deviations from a plan, and if these changes or deviations may affect the scientific soundness of the plan or the rights, safety, or welfare of human subjects, FDA and IRB in accordance with § 812.35(a) also is required.

(5) *Informed consent.* If an investigator uses a device without obtaining informed consent, the investigator shall report such use to the sponsor and the reviewing IRB within 5 working days after the use occurs.

(6) *Final report.* An investigator shall, within 3 months after termination or completion of the investigation or the investigator's part of the investigation, submit a final report to the sponsor and the reviewing IRB.

(7) *Other.* An investigator shall, upon request by a reviewing IRB or FDA, provide accurate, complete, and current information about any aspect of the investigation.

(b) *Sponsor reports.* A sponsor shall prepare and submit the following complete, accurate, and timely reports:

(1) *Unanticipated adverse device effects.* A sponsor who conducts an evaluation of an unanticipated adverse device ef-

fect under § 812.46(b) shall report the results of such evaluation to FDA and to all reviewing IRB's and participating investigators within 10 working days after the sponsor first receives notice of the effect. Thereafter the sponsor shall submit such additional reports concerning the effect as FDA requests.

(2) *Withdrawal of IRB approval.* A sponsor shall notify FDA and all reviewing IRB's and participating investigators of any withdrawal of approval of an investigation or a part of an investigation by a reviewing IRB within 5 working days after receipt of the withdrawal of approval.

(3) *Withdrawal of FDA approval.* A sponsor shall notify all reviewing IRB's and participating investigators of any withdrawal of FDA approval of the investigation, and shall do so within 5 working days after receipt of notice of the withdrawal of approval.

(4) *Current investigator list.* A sponsor shall submit to FDA, at 6-month intervals, a current list of the names and addresses of all investigators participating in the investigation. The sponsor shall submit the first such list 6 months after FDA approval.

(5) *Progress reports.* At regular intervals, and at least yearly, a sponsor shall submit progress reports to all reviewing IRB's. In the case of a significant risk device, a sponsor shall also submit progress reports to FDA. A sponsor of a treatment IDE shall submit semi-annual progress reports to all reviewing IRB's and FDA in accordance with § 812.36(f) and annual reports in accordance with this section.

(6) *Recall and device disposition.* A sponsor shall notify FDA and all reviewing IRB's of any request that an investigator return, repair, or otherwise dispose of any units of a device. Such notice shall occur within 30 working days after the request is made and shall state why the request was made.

(7) *Final report.* In the case of a significant risk device, the sponsor shall notify FDA within 30 working days of the completion or termination of the investigation and shall submit a final report to FDA and all reviewing the IRB's and participating investigators within 6 months after completion or termination. In the case of a device that is not a significant risk device,

**Pt. 814**

the sponsor shall submit a final report to all reviewing IRB's within 6 months after termination or completion.

(8) *Informed consent.* A sponsor shall submit to FDA a copy of any report by an investigator under paragraph (a)(5) of this section of use of a device without obtaining informed consent, within 5 working days of receipt of notice of such use.

(9) *Significant risk device determinations.* If an IRB determines that a device is a significant risk device, and the sponsor had proposed that the IRB consider the device not to be a significant risk device, the sponsor shall submit to FDA a report of the IRB's determination within 5 working days after the sponsor first learns of the IRB's determination.

(10) *Other.* A sponsor shall, upon request by a reviewing IRB or FDA, provide accurate, complete, and current information about any aspect of the investigation.

[45 FR 3751, Jan. 18, 1980, as amended at 45 FR 58843, Sept. 5, 1980; 48 FR 15622, Apr. 12, 1983; 62 FR 48948, Sept. 18, 1997]

**PART 813 [RESERVED]**

**PART 814—PREMARKET APPROVAL OF MEDICAL DEVICES**

**Subpart A—General**

- Sec.
- 814.1 Scope.
- 814.2 Purpose.
- 814.3 Definitions.
- 814.9 Confidentiality of data and information in a premarket approval application (PMA) file.
- 814.15 Research conducted outside the United States.
- 814.17 Service of orders.
- 814.19 Product development protocol (PDP).

**Subpart B—Premarket Approval Application (PMA)**

- 814.20 Application.
- 814.37 PMA amendments and resubmitted PMAs.
- 814.39 PMA supplements.

**Subpart C—FDA Action on a PMA**

- 814.40 Time frames for reviewing a PMA.
- 814.42 Filing a PMA.
- 814.44 Procedures for review of a PMA.
- 814.45 Denial of approval of a PMA.

**21 CFR Ch. I (4–1–20 Edition)**

- 814.46 Withdrawal of approval of a PMA.
- 814.47 Temporary suspension of approval of a PMA.

**Subpart D—Administrative Review [Reserved]**

**Subpart E—Postapproval Requirements**

- 814.80 General.
- 814.82 Postapproval requirements.
- 814.84 Reports.

**Subparts F–G [Reserved]**

**Subpart H—Humanitarian Use Devices**

- 814.100 Purpose and scope.
- 814.102 Designation of HUD status.
- 814.104 Original applications.
- 814.106 HDE amendments and resubmitted HDE's.
- 814.108 Supplemental applications.
- 814.110 New indications for use.
- 814.112 Filing an HDE.
- 814.114 Timeframes for reviewing an HDE.
- 814.116 Procedures for review of an HDE.
- 814.118 Denial of approval or withdrawal of approval of an HDE.
- 814.120 Temporary suspension of approval of an HDE.
- 814.122 Confidentiality of data and information.
- 814.124 Institutional Review Board requirements.
- 814.126 Postapproval requirements and reports.

AUTHORITY: 21 U.S.C. 351, 352, 353, 360, 360c–360j, 360bbb–8b, 371, 372, 373, 374, 375, 379, 379e, 379k–1, 381.

SOURCE: 51 FR 26364, July 22, 1986, unless otherwise noted.

**Subpart A—General**

**§ 814.1 Scope.**

(a) This section implements sections 515 and 515A of the act by providing procedures for the premarket approval of medical devices intended for human use.

(b) References in this part to regulatory sections of the Code of Federal Regulations are to chapter I of title 21, unless otherwise noted.

(c) This part applies to any class III medical device, unless exempt under section 520(g) of the act, that:

(1) Was not on the market (introduced or delivered for introduction into commerce for commercial distribution) before May 28, 1976, and is not substantially equivalent to a device on the



market before May 28, 1976, or to a device first marketed on, or after that date, which has been classified into class I or class II; or

(2) Is required to have an approved premarket approval application (PMA) or a declared completed product development protocol under a regulation issued under section 515(b) of the act; or

(3) Was regulated by FDA as a new drug or antibiotic drug before May 28, 1976, and therefore is governed by section 520(1) of the act.

(d) This part amends the conditions to approval for any PMA approved before the effective date of this part. Any condition to approval for an approved PMA that is inconsistent with this part is revoked. Any condition to approval for an approved PMA that is consistent with this part remains in effect.

[51 FR 26364, July 22, 1986, as amended at 79 FR 1740, Jan. 10, 2014]

#### § 814.2 Purpose.

The purpose of this part is to establish an efficient and thorough device review process—

(a) To facilitate the approval of PMA's for devices that have been shown to be safe and effective and that otherwise meet the statutory criteria for approval; and

(b) To ensure the disapproval of PMA's for devices that have not been shown to be safe and effective or that do not otherwise meet the statutory criteria for approval. This part shall be construed in light of these objectives.

#### § 814.3 Definitions.

For the purposes of this part:

(a) *Act* means the Federal Food, Drug, and Cosmetic Act (sections 201–902, 52 Stat. 1040 *et seq.*, as amended (21 U.S.C. 321–392)).

(b) *FDA* means the Food and Drug Administration.

(c) *IDE* means an approved or considered approved investigational device exemption under section 520(g) of the act and parts 812 and 813.

(d) *Master file* means a reference source that a person submits to FDA. A master file may contain detailed information on a specific manufacturing facility, process, methodology, or component used in the manufacture, proc-

essing, or packaging of a medical device.

(e) *PMA* means any premarket approval application for a class III medical device, including all information submitted with or incorporated by reference therein. “PMA” includes a new drug application for a device under section 520(1) of the act.

(f) *PMA amendment* means information an applicant submits to FDA to modify a pending PMA or a pending PMA supplement.

(g) *PMA supplement* means a supplemental application to an approved PMA for approval of a change or modification in a class III medical device, including all information submitted with or incorporated by reference therein.

(h) *Person* includes any individual, partnership, corporation, association, scientific or academic establishment, Government agency, or organizational unit thereof, or any other legal entity.

(i) *Statement of material fact* means a representation that tends to show that the safety or effectiveness of a device is more probable than it would be in the absence of such a representation. A false affirmation or silence or an omission that would lead a reasonable person to draw a particular conclusion as to the safety or effectiveness of a device also may be a false statement of material fact, even if the statement was not intended by the person making it to be misleading or to have any probative effect.

(j) *30-day PMA supplement* means a supplemental application to an approved PMA in accordance with § 814.39(e).

(k) *Reasonable probability* means that it is more likely than not that an event will occur.

(l) *Serious, adverse health consequences* means any significant adverse experience, including those which may be either life-threatening or involve permanent or long term injuries, but excluding injuries that are nonlife-threatening and that are temporary and reasonably reversible.

(m) *HDE* means a premarket approval application submitted pursuant to this subpart seeking a humanitarian device exemption from the effectiveness requirements of sections 514 and 515 of

## §814.9

## 21 CFR Ch. I (4–1–20 Edition)

the act as authorized by section 520(m)(2) of the act.

(n) *HUD (humanitarian use device)* means a medical device intended to benefit patients in the treatment or diagnosis of a disease or condition that affects or is manifested in not more than 8,000 individuals in the United States per year.

(o) *Newly acquired information* means data, analyses, or other information not previously submitted to the agency, which may include (but are not limited to) data derived from new clinical studies, reports of adverse events, or new analyses of previously submitted data (e.g., meta-analyses) if the studies, events or analyses reveal risks of a different type or greater severity or frequency than previously included in submissions to FDA.

(p) *Human cell, tissue, or cellular or tissue-based product (HCT/P) regulated as a device* means an HCT/P as defined in §1271.3(d) of this chapter that does not meet the criteria in §1271.10(a) and that is also regulated as a device.

(q) *Unique device identifier (UDI)* means an identifier that adequately identifies a device through its distribution and use by meeting the requirements of §830.20 of this chapter. A unique device identifier is composed of:

(1) A *device identifier*—a mandatory, fixed portion of a UDI that identifies the specific version or model of a device and the labeler of that device; and

(2) A *production identifier*—a conditional, variable portion of a UDI that identifies one or more of the following when included on the label of the device:

(i) The lot or batch within which a device was manufactured;

(ii) The serial number of a specific device;

(iii) The expiration date of a specific device;

(iv) The date a specific device was manufactured.

(v) For an HCT/P regulated as a device, the distinct identification code required by §1271.290(c) of this chapter.

(r) *Universal product code (UPC)* means the product identifier used to identify an item sold at retail in the United States.

(s) *Pediatric patients* means patients who are 21 years of age or younger

(that is, from birth through the twenty-first year of life, up to but not including the twenty-second birthday) at the time of the diagnosis or treatment.

(t) *Readily available* means available in the public domain through commonly used public resources for conducting biomedical, regulatory, and medical product research.

[51 FR 26364, July 22, 1986, as amended at 61 FR 15190, Apr. 5, 1996; 61 FR 33244, June 26, 1996; 73 FR 49610, Aug. 22, 2008; 78 FR 58821, Sept. 24, 2013; 79 FR 1740, Jan. 10, 2014; 82 FR 26349, June 7, 2017]

### §814.9 Confidentiality of data and information in a premarket approval application (PMA) file.

(a) A “PMA file” includes all data and information submitted with or incorporated by reference in the PMA, any IDE incorporated into the PMA, any PMA supplement, any report under §814.82, any master file, or any other related submission. Any record in the PMA file will be available for public disclosure in accordance with the provisions of this section and part 20. The confidentiality of information in a color additive petition submitted as part of a PMA is governed by §71.15.

(b) The existence of a PMA file may not be disclosed by FDA before an approval order is issued to the applicant unless it previously has been publicly disclosed or acknowledged.

(c) If the existence of a PMA file has not been publicly disclosed or acknowledged, data or information in the PMA file are not available for public disclosure.

(d)(1) If the existence of a PMA file has been publicly disclosed or acknowledged before an order approving, or an order denying approval of the PMA is issued, data or information contained in the file are not available for public disclosure before such order issues. FDA may, however, disclose a summary of portions of the safety and effectiveness data before an approval order or an order denying approval of the PMA issues if disclosure is relevant to public consideration of a specific pending issue.

(2) Notwithstanding paragraph (d)(1) of this section, FDA will make available to the public upon request the information in the IDE that was required

to be filed in Docket Number 95S-0158 in the Division of Dockets Management (HFA-305), Food and Drug Administration, 12420 Parklawn Dr., rm. 1-23, Rockville, MD 20857, for investigations involving an exception from informed consent under §50.24 of this chapter. Persons wishing to request this information shall submit a request under the Freedom of Information Act.

(e) Upon issuance of an order approving, or an order denying approval of any PMA, FDA will make available to the public the fact of the existence of the PMA and a detailed summary of information submitted to FDA respecting the safety and effectiveness of the device that is the subject of the PMA and that is the basis for the order.

(f) After FDA issues an order approving, or an order denying approval of any PMA, the following data and information in the PMA file are immediately available for public disclosure:

(1) All safety and effectiveness data and information previously disclosed to the public, as such disclosure is defined in §20.81.

(2) Any protocol for a test or study unless the protocol is shown to constitute trade secret or confidential commercial or financial information under §20.61.

(3) Any adverse reaction report, product experience report, consumer complaint, and other similar data and information, after deletion of:

(i) Any information that constitutes trade secret or confidential commercial or financial information under §20.61; and

(ii) Any personnel, medical, and similar information disclosure of which would constitute a clearly unwarranted invasion of personal privacy under §20.63; provided, however, that except for the information that constitutes trade secret or confidential commercial or financial information under §20.61, FDA will disclose to a patient who requests a report all the information in the report concerning that patient.

(4) A list of components previously disclosed to the public, as such disclosure is defined in §20.81.

(5) An assay method or other analytical method, unless it does not serve any regulatory purpose and is shown to

fall within the exemption in §20.61 for trade secret or confidential commercial or financial information.

(6) All correspondence and written summaries of oral discussions relating to the PMA file, in accordance with the provisions of §§20.103 and 20.104.

(g) All safety and effectiveness data and other information not previously disclosed to the public are available for public disclosure if any one of the following events occurs and the data and information do not constitute trade secret or confidential commercial or financial information under §20.61:

(1) The PMA has been abandoned. FDA will consider a PMA abandoned if:

(i)(A) The applicant fails to respond to a request for additional information within 180 days after the date FDA issues the request or

(B) Other circumstances indicate that further work is not being undertaken with respect to it, and

(ii) The applicant fails to communicate with FDA within 7 days after the date on which FDA notifies the applicant that the PMA appears to have been abandoned.

(2) An order denying approval of the PMA has issued, and all legal appeals have been exhausted.

(3) An order withdrawing approval of the PMA has issued, and all legal appeals have been exhausted.

(4) The device has been reclassified.

(5) The device has been found to be substantially equivalent to a class I or class II device.

(6) The PMA is considered voluntarily withdrawn under §814.44(g).

(h) The following data and information in a PMA file are not available for public disclosure unless they have been previously disclosed to the public, as such disclosure is defined in §20.81, or they relate to a device for which a PMA has been abandoned and they no longer represent a trade secret or confidential commercial or financial information as defined in §20.61:

(1) Manufacturing methods or processes, including quality control procedures.

(2) Production, sales, distribution, and similar data and information, except that any compilation of such data and information aggregated and prepared in a way that does not reveal

## § 814.15

data or information which are not available for public disclosure under this provision is available for public disclosure.

(3) Quantitative or semiquantitative formulas.

[51 FR 26364, July 22, 1986, as amended at 61 FR 51531, Oct. 2, 1996]

### § 814.15 Research conducted outside the United States.

(a) *Data to support PMA.* If data from clinical investigations conducted outside the United States are submitted to support a PMA, the applicant shall comply with the provisions in § 812.28 of this chapter, as applicable.

(b) *As sole basis for marketing approval.* A PMA based solely on foreign clinical data and otherwise meeting the criteria for approval under this part may be approved if:

(1) The foreign data are applicable to the U.S. population and U.S. medical practice;

(2) The studies have been performed by clinical investigators of recognized competence; and

(3) The data may be considered valid without the need for an on-site inspection by FDA or, if FDA considers such an inspection to be necessary, FDA can validate the data through an on-site inspection or other appropriate means.

(c) *Consultation between FDA and applicants.* Applicants are encouraged to meet with FDA officials in a “pre-submission” meeting when approval based solely on foreign data will be sought.

[51 FR 26364, July 22, 1986; 51 FR 40415, Nov. 7, 1986, as amended at 51 FR 43344, Dec. 2, 1986; 83 FR 7387, Feb. 21, 2018]

### § 814.17 Service of orders.

Orders issued under this part will be served in person by a designated officer or employee of FDA on, or by registered mail to, the applicant or the designated agent at the applicant's or designated agent's last known address in FDA's records.

### § 814.19 Product development protocol (PDP).

A class III device for which a product development protocol has been declared completed by FDA under this

## 21 CFR Ch. I (4–1–20 Edition)

chapter will be considered to have an approved PMA.

### Subpart B—Premarket Approval Application (PMA)

#### § 814.20 Application.

(a) The applicant or an authorized representative shall sign the PMA. If the applicant does not reside or have a place of business within the United States, the PMA shall be countersigned by an authorized representative residing or maintaining a place of business in the United States and shall identify the representative's name and address.

(b) Unless the applicant justifies an omission in accordance with paragraph (d) of this section, a PMA shall include in electronic format:

(1) The name and address of the applicant.

(2) A table of contents that specifies the volume and page number for each item referred to in the table. A PMA shall include separate sections on non-clinical laboratory studies and on clinical investigations involving human subjects. A PMA shall be submitted as a single version. The applicant shall include information that it believes to be trade secret or confidential commercial or financial information in the PMA and identify the information that it believes to be trade secret or confidential commercial or financial information.

(3) A summary in sufficient detail that the reader may gain a general understanding of the data and information in the application. The summary shall contain the following information:

(i) *Indications for use.* A general description of the disease or condition the device will diagnose, treat, prevent, cure, or mitigate, including a description of the patient population for which the device is intended.

(ii) *Device description.* An explanation of how the device functions, the basic scientific concepts that form the basis for the device, and the significant physical and performance characteristics of the device. A brief description of the manufacturing process should be included if it will significantly enhance the reader's understanding of the device. The generic name of the device as

well as any proprietary name or trade name should be included.

(iii) *Alternative practices and procedures.* A description of existing alternative practices or procedures for diagnosing, treating, preventing, curing, or mitigating the disease or condition for which the device is intended.

(iv) *Marketing history.* A brief description of the foreign and U.S. marketing history, if any, of the device, including a list of all countries in which the device has been marketed and a list of all countries in which the device has been withdrawn from marketing for any reason related to the safety or effectiveness of the device. The description shall include the history of the marketing of the device by the applicant and, if known, the history of the marketing of the device by any other person.

(v) *Summary of studies.* An abstract of any information or report described in the PMA under paragraph (b)(8)(ii) of this section and a summary of the results of technical data submitted under paragraph (b)(6) of this section. Such summary shall include a description of the objective of the study, a description of the experimental design of the study, a brief description of how the data were collected and analyzed, and a brief description of the results, whether positive, negative, or inconclusive. This section shall include the following:

(A) A summary of the nonclinical laboratory studies submitted in the application;

(B) A summary of the clinical investigations involving human subjects submitted in the application including a discussion of subject selection and exclusion criteria, study population, study period, safety and effectiveness data, adverse reactions and complications, patient discontinuation, patient complaints, device failures and replacements, results of statistical analyses of the clinical investigations, contraindications and precautions for use of the device, and other information from the clinical investigations as appropriate (any investigation conducted under an IDE shall be identified as such).

(vi) *Conclusions drawn from the studies.* A discussion demonstrating that

the data and information in the application constitute valid scientific evidence within the meaning of § 860.7 and provide reasonable assurance that the device is safe and effective for its intended use. A concluding discussion shall present benefit and risk considerations related to the device including a discussion of any adverse effects of the device on health and any proposed additional studies or surveillance the applicant intends to conduct following approval of the PMA.

(4) A complete description of:

(i) The device, including pictorial representations;

(ii) Each of the functional components or ingredients of the device if the device consists of more than one physical component or ingredient;

(iii) The properties of the device relevant to the diagnosis, treatment, prevention, cure, or mitigation of a disease or condition;

(iv) The principles of operation of the device; and

(v) The methods used in, and the facilities and controls used for, the manufacture, processing, packing, storage, and, where appropriate, installation of the device, in sufficient detail so that a person generally familiar with current good manufacturing practice can make a knowledgeable judgment about the quality control used in the manufacture of the device.

(5) Reference to any performance standard under section 514 of the Federal Food, Drug, and Cosmetic Act or under section 534 of Subchapter C—Electronic Product Radiation Control of the Federal Food, Drug, and Cosmetic Act (formerly the Radiation Control for Health and Safety Act of 1968) in effect or proposed at the time of the submission and to any voluntary standard that is relevant to any aspect of the safety or effectiveness of the device and that is known to or that should reasonably be known to the applicant. The applicant shall—

(i) Provide adequate information to demonstrate how the device meets, or justify any deviation from, any performance standard established under section 514 of the Federal Food, Drug, and Cosmetic Act or under section 534 of Subchapter C—Electronic Product Radiation Control of the Federal Food,

Drug, and Cosmetic Act (formerly the Radiation Control for Health and Safety Act of 1968); and

(ii) Explain any deviation from a voluntary standard.

(6) The following technical sections which shall contain data and information in sufficient detail to permit FDA to determine whether to approve or deny approval of the application:

(i) A section containing results of the nonclinical laboratory studies with the device including microbiological, toxicological, immunological, biocompatibility, stress, wear, shelf life, and other laboratory or animal tests as appropriate. Information on nonclinical laboratory studies shall include a statement that each such study was conducted in compliance with part 58, or, if the study was not conducted in compliance with such regulations, a brief statement of the reason for the noncompliance.

(ii) A section containing results of the clinical investigations involving human subjects with the device including clinical protocols, number of investigators and subjects per investigator, subject selection and exclusion criteria, study population, study period, safety and effectiveness data, adverse reactions and complications, patient discontinuation, patient complaints, device failures and replacements, tabulations of data from all individual subject report forms and copies of such forms for each subject who died during a clinical investigation or who did not complete the investigation, results of statistical analyses of the clinical investigations, device failures and replacements, contraindications and precautions for use of the device, and any other appropriate information from the clinical investigations. Any investigation conducted under an IDE shall be identified as such. Information on clinical investigations involving human subjects shall include the following:

(A) For clinical investigations conducted in the United States, a statement with respect to each investigation that it either was conducted in compliance with the institutional review board regulations in part 56 of this chapter, or was not subject to the regulations under §56.104 or §56.105, and that it was conducted in compliance

with the informed consent regulations in part 50 of this chapter; or if the investigation was not conducted in compliance with those regulations, a brief statement of the reason for the noncompliance. Failure or inability to comply with these requirements does not justify failure to provide information on a relevant clinical investigation.

(B) For clinical investigations conducted in the United States, a statement that each investigation was conducted in compliance with part 812 of this chapter concerning sponsors of clinical investigations and clinical investigators, or if the investigation was not conducted in compliance with those regulations, a brief statement of the reason for the noncompliance. Failure or inability to comply with these requirements does not justify failure to provide information on a relevant clinical investigation.

(C) For clinical investigations conducted outside the United States that are intended to support the PMA, the requirements under §812.28 of this chapter apply. If any such investigation was not conducted in accordance with good clinical practice (GCP) as described in §812.28(a), include either a waiver request in accordance with §812.28(c) or a brief statement of the reason for not conducting the investigation in accordance with GCP and a description of steps taken to ensure that the data and results are credible and accurate and that the rights, safety, and well-being of subjects have been adequately protected. Failure or inability to comply with these requirements does not justify failure to provide information on a relevant clinical investigation.

(7) For a PMA supported solely by data from one investigation, a justification showing that data and other information from a single investigator are sufficient to demonstrate the safety and effectiveness of the device and to ensure reproducibility of test results.

(8)(i) A bibliography of all published reports not submitted under paragraph (b)(6) of this section, whether adverse or supportive, known to or that should reasonably be known to the applicant

and that concern the safety or effectiveness of the device.

(ii) An identification, discussion, and analysis of any other data, information, or report relevant to an evaluation of the safety and effectiveness of the device known to or that should reasonably be known to the applicant from any source, foreign or domestic, including information derived from investigations other than those proposed in the application and from commercial marketing experience.

(iii) Copies of such published reports or unpublished information in the possession of or reasonably obtainable by the applicant if an FDA advisory committee or FDA requests.

(9) One or more samples of the device and its components, if requested by FDA. If it is impractical to submit a requested sample of the device, the applicant shall name the location at which FDA may examine and test one or more devices.

(10) Copies of all proposed labeling for the device. Such labeling may include, e.g., instructions for installation and any information, literature, or advertising that constitutes labeling under section 201(m) of the Federal Food, Drug, and Cosmetic Act.

(11) An environmental assessment under § 25.20(n) prepared in the applicable format in § 25.40, unless the action qualifies for exclusion under § 25.30 or § 25.34. If the applicant believes that the action qualifies for exclusion, the PMA shall under § 25.15(a) and (d) provide information that establishes to FDA's satisfaction that the action requested is included within the excluded category and meets the criteria for the applicable exclusion.

(12) A financial certification or disclosure statement or both as required by part 54 of this chapter.

(13) *Information concerning uses in pediatric patients.* The application must include the following information, if readily available:

(i) A description of any pediatric subpopulations (neonates, infants, children, adolescents) that suffer from the disease or condition that the device is intended to treat, diagnose, or cure; and

(ii) The number of affected pediatric patients.

(14) Such other information as FDA may request. If necessary, FDA will obtain the concurrence of the appropriate FDA advisory committee before requesting additional information.

(c) Pertinent information in FDA files specifically referred to by an applicant may be incorporated into a PMA by reference. Information in a master file or other information submitted to FDA by a person other than the applicant will not be considered part of a PMA unless such reference is authorized in a record submitted to FDA by the person who submitted the information or the master file. If a master file is not referenced within 5 years after the date that it is submitted to FDA, FDA will return the master file to the person who submitted it.

(d) If the applicant believes that certain information required under paragraph (b) of this section to be in a PMA is not applicable to the device that is the subject of the PMA, and omits any such information from its PMA, the applicant shall submit a statement that identifies the omitted information and justifies the omission. The statement shall be submitted as a separate section in the PMA and identified in the table of contents. If the justification for the omission is not accepted by the agency, FDA will so notify the applicant.

(e) The applicant shall periodically update its pending application with new safety and effectiveness information learned about the device from ongoing or completed studies that may reasonably affect an evaluation of the safety or effectiveness of the device or that may reasonably affect the statement of contraindications, warnings, precautions, and adverse reactions in the draft labeling. The update report shall be consistent with the data reporting provisions of the protocol. The applicant shall submit any update report in electronic format and shall include in the report the number assigned by FDA to the PMA. These updates are considered to be amendments to the PMA. The time frame for review of a PMA will not be extended due to the submission of an update report unless the update is a major amendment

## § 814.37

## 21 CFR Ch. I (4–1–20 Edition)

under § 814.37(c)(1). The applicant shall submit these reports—

- (1) 3 months after the filing date;
- (2) Following receipt of an approvable letter; and
- (3) At any other time as requested by FDA.

(f) If a color additive subject to section 721 of the Federal Food, Drug, and Cosmetic Act is used in or on the device and has not previously been listed for such use, then, in lieu of submitting a color additive petition under part 71 of this chapter, at the option of the applicant, the information required to be submitted under part 71 may be submitted as part of the PMA. When submitted as part of the PMA, the information shall be submitted in electronic format. A PMA for a device that contains a color additive that is subject to section 721 of the Federal Food, Drug, and Cosmetic Act will not be approved until the color additive is listed for use in or on the device.

(g) Additional information on FDA policies and procedures, as well as links to PMA guidance documents, is available on the Internet at <http://www.fda.gov/MedicalDevices/DeviceRegulationandGuidance/HowtoMarketYourDevice/PremarketSubmissions/PremarketApprovalPMA/default.htm>.

(h) If you are sending a PMA, PMA amendment, PMA supplement, or correspondence with respect to a PMA, you must send the submission to the appropriate address as follows:

(1) For devices regulated by the Center for Devices and Radiological Health, send it to the current address displayed on the website <https://www.fda.gov/cdrhsubmissionaddress>.

(2) For devices regulated by the Center for Biologics Evaluation and Research, send it to the current address displayed on the website <https://www.fda.gov/AboutFDA/CentersOffices/OfficeofMedicalProductsandTobacco/CBER/ucm385240.htm>.

(3) For devices regulated by the Center for Drug Evaluation and Research, send it to: Central Document Control Room, Center for Drug Evaluation and Research, Food and Drug Administra-

tion, 5901–B Ammendale Rd., Beltsville, MD 20705–1266.

[51 FR 26364, July 22, 1986; 51 FR 40415, Nov. 7, 1986, as amended at 51 FR 43344, Dec. 2, 1986; 55 FR 11169, Mar. 27, 1990; 62 FR 40600, July 29, 1997; 63 FR 5253, Feb. 2, 1998; 65 FR 17137, Mar. 31, 2000; 65 FR 56480, Sept. 19, 2000; 67 FR 9587, Mar. 4, 2002; 71 FR 42048, July 25, 2006; 72 FR 17399, Apr. 9, 2007; 73 FR 34859, June 19, 2008; 74 FR 14478, Mar. 31, 2009; 75 FR 20915, Apr. 22, 2010; 78 FR 18233, Mar. 26, 2013; 79 FR 1740, Jan. 10, 2014; 80 FR 18094, Apr. 3, 2015; 83 FR 7387, Feb. 21, 2018; 84 FR 68339, Dec. 16, 2019]

### § 814.37 PMA amendments and resubmitted PMAs.

(a) An applicant may amend a pending PMA or PMA supplement to revise existing information or provide additional information.

(b)(1) FDA may request the applicant to amend a PMA or PMA supplement with any information regarding the device that is necessary for FDA or the appropriate advisory committee to complete the review of the PMA or PMA supplement.

(2) FDA may request the applicant to amend a PMA or PMA supplement with information concerning pediatric uses as required under §§ 814.20(b)(13) and 814.39(c)(2).

(c) A PMA amendment submitted to FDA shall include the PMA or PMA supplement number assigned to the original submission and, if submitted on the applicant's own initiative, the reason for submitting the amendment. FDA may extend the time required for its review of the PMA, or PMA supplement, as follows:

(1) If the applicant on its own initiative or at FDA's request submits a major PMA amendment (e.g., an amendment that contains significant new data from a previously unreported study, significant updated data from a previously reported study, detailed new analyses of previously submitted data, or significant required information previously omitted), the review period may be extended up to 180 days.

(2) If an applicant declines to submit a major amendment requested by FDA, the review period may be extended for the number of days that elapse between the date of such request and the date that FDA receives the written response



declining to submit the requested amendment.

(d) An applicant may on its own initiative withdraw a PMA or PMA supplement. If FDA requests an applicant to submit a PMA amendment and a written response to FDA's request is not received within 180 days of the date of the request, FDA will consider the pending PMA or PMA supplement to be withdrawn voluntarily by the applicant.

(e) An applicant may resubmit a PMA or PMA supplement after withdrawing it or after it is considered withdrawn under paragraph (d) of this section, or after FDA has refused to accept it for filing, or has denied approval of the PMA or PMA supplement. A resubmitted PMA or PMA supplement shall comply with the requirements of §814.20 or §814.39, respectively, and shall include the PMA number assigned to the original submission and the applicant's reasons for resubmission of the PMA or PMA supplement.

[51 FR 26364, July 22, 1986, as amended at 79 FR 1740, Jan. 10, 2014]

#### § 814.39 PMA supplements.

(a) After FDA's approval of a PMA, an applicant shall submit a PMA supplement for review and approval by FDA before making a change affecting the safety or effectiveness of the device for which the applicant has an approved PMA, unless the change is of a type for which FDA, under paragraph (e) of this section, has advised that an alternate submission is permitted or is of a type which, under section 515(d)(6)(A) of the act and paragraph (f) of this section, does not require a PMA supplement under this paragraph. While the burden for determining whether a supplement is required is primarily on the PMA holder, changes for which an applicant shall submit a PMA supplement include, but are not limited to, the following types of changes if they affect the safety or effectiveness of the device:

(1) New indications for use of the device.

(2) Labeling changes.

(3) The use of a different facility or establishment to manufacture, process, or package the device.

(4) Changes in sterilization procedures.

(5) Changes in packaging.

(6) Changes in the performance or design specifications, circuits, components, ingredients, principle of operation, or physical layout of the device.

(7) Extension of the expiration date of the device based on data obtained under a new or revised stability or sterility testing protocol that has not been approved by FDA. If the protocol has been approved, the change shall be reported to FDA under paragraph (b) of this section.

(b) An applicant may make a change in a device after FDA's approval of a PMA for the device without submitting a PMA supplement if the change does not affect the device's safety or effectiveness and the change is reported to FDA in postapproval periodic reports required as a condition to approval of the device, e.g., an editorial change in labeling which does not affect the safety or effectiveness of the device.

(c)(1) All procedures and actions that apply to an application under §814.20 also apply to PMA supplements except that the information required in a supplement is limited to that needed to support the change. A summary under §814.20(b)(3) is required for only a supplement submitted for new indications for use of the device, significant changes in the performance or design specifications, circuits, components, ingredients, principles of operation, or physical layout of the device, or when otherwise required by FDA. The applicant shall submit a PMA supplement in electronic format and shall include information relevant to the proposed changes in the device. A PMA supplement shall include a separate section that identifies each change for which approval is being requested and explains the reason for each such change. The applicant shall submit additional information, if requested by FDA, in electronic format. The time frames for review of, and FDA action on, a PMA supplement are the same as those provided in §814.40 for a PMA.

(2) The supplement must include the following information:

(i) Information concerning pediatric uses as required under §814.20(b)(13).

(ii) If information concerning the device that is the subject of the supplement was previously submitted under §814.20(b)(13) or under this section in a previous supplement, that information may be included by referencing a previous application or submission that contains the information. However, if additional information required under §814.20(b)(13) has become readily available to the applicant since the previous submission, the applicant must submit that information as part of the supplement.

(d)(1) After FDA approves a PMA, any change described in paragraph (d)(2) of this section to reflect newly acquired information that enhances the safety of the device or the safety in the use of the device may be placed into effect by the applicant prior to the receipt under §814.17 of a written FDA order approving the PMA supplement provided that:

(i) The PMA supplement and its mailing cover are plainly marked “Special PMA Supplement—Changes Being Effected”;

(ii) The PMA supplement provides a full explanation of the basis for the changes;

(iii) The applicant has received acknowledgement from FDA of receipt of the supplement; and

(iv) The PMA supplement specifically identifies the date that such changes are being effected.

(2) The following changes are permitted by paragraph (d)(1) of this section:

(i) Labeling changes that add or strengthen a contraindication, warning, precaution, or information about an adverse reaction for which there is reasonable evidence of a causal association.

(ii) Labeling changes that add or strengthen an instruction that is intended to enhance the safe use of the device.

(iii) Labeling changes that delete misleading, false, or unsupported indications.

(iv) Changes in quality controls or manufacturing process that add a new specification or test method, or otherwise provide additional assurance of purity, identity, strength, or reliability of the device.

(e)(1) FDA will identify a change to a device for which an applicant has an approved PMA and for which a PMA supplement under paragraph (a) is not required. FDA will identify such a change in an advisory opinion under §10.85, if the change applies to a generic type of device, or in correspondence to the applicant, if the change applies only to the applicant’s device. FDA will require that a change for which a PMA supplement under paragraph (a) is not required be reported to FDA in:

(i) A periodic report under §814.84 or

(ii) A 30-day PMA supplement under this paragraph.

(2) FDA will identify, in the advisory opinion or correspondence, the type of information that is to be included in the report or 30-day PMA supplement. If the change is required to be reported to FDA in a periodic report, the change may be made before it is reported to FDA. If the change is required to be reported in a 30-day PMA supplement, the change may be made 30 days after FDA files the 30-day PMA supplement unless FDA requires the PMA holder to provide additional information, informs the PMA holder that the supplement is not approvable, or disapproves the supplement. The 30-day PMA supplement shall follow the instructions in the correspondence or advisory opinion. Any 30-day PMA supplement that does not meet the requirements of the correspondence or advisory opinion will not be filed and, therefore, will not be deemed approved 30 days after receipt.

(f) Under section 515(d) of the act, modifications to manufacturing procedures or methods of manufacture that affect the safety and effectiveness of a device subject to an approved PMA do not require submission of a PMA supplement under paragraph (a) of this section and are eligible to be the subject of a 30-day notice. A 30-day notice shall describe in detail the change, summarize the data or information supporting the change, and state that the change has been made in accordance with the requirements of part 820 of this chapter. The manufacturer may distribute the device 30 days after the date on which FDA receives the 30-day

notice, unless FDA notifies the applicant within 30 days from receipt of the notice that the notice is not adequate. If the notice is not adequate, FDA shall inform the applicant in writing that a 135-day PMA supplement is needed and shall describe what further information or action is required for acceptance of such change. The number of days under review as a 30-day notice shall be deducted from the 135-day PMA supplement review period if the notice meets appropriate content requirements for a PMA supplement.

(g) The submission and grant of a written request for an exception or alternative under § 801.128 or § 809.11 of this chapter satisfies the requirement in paragraph (a) of this section.

[51 FR 26364, July 22, 1986, as amended at 51 FR 43344, Dec. 2, 1986; 63 FR 54044, Oct. 8, 1998; 67 FR 9587, Mar. 4, 2002; 69 FR 11313, Mar. 10, 2004; 72 FR 73602, Dec. 28, 2007; 73 FR 49610, Aug. 22, 2008; 79 FR 1740, Jan. 10, 2014; 84 FR 68340, Dec. 16, 2019]

### Subpart C—FDA Action on a PMA

#### § 814.40 Time frames for reviewing a PMA.

Within 180 days after receipt of an application that is accepted for filing and to which the applicant does not submit a major amendment, FDA will review the PMA and, after receiving the report and recommendation of the appropriate FDA advisory committee, send the applicant an approval order under § 814.44(d), an approvable letter under § 814.44(e), a not approvable letter under § 814.44(f), or an order denying approval under § 814.45. The approvable letter and the not approvable letter will provide an opportunity for the applicant to amend or withdraw the application, or to consider the letter to be a denial of approval of the PMA under § 814.45 and to request administrative review under section 515 (d)(3) and (g) of the act.

#### § 814.42 Filing a PMA.

(a) The filing of an application means that FDA has made a threshold determination that the application is sufficiently complete to permit a substantive review. Within 45 days after a PMA is received by FDA, the agency

will notify the applicant whether the application has been filed.

(b) If FDA does not find that any of the reasons in paragraph (e) of this section for refusing to file the PMA applies, the agency will file the PMA and will notify the applicant in writing of the filing. The notice will include the PMA reference number and the date FDA filed the PMA. The date of filing is the date that a PMA accepted for filing was received by the agency. The 180-day period for review of a PMA starts on the date of filing.

(c) If FDA refuses to file a PMA, the agency will notify the applicant of the reasons for the refusal. This notice will identify the deficiencies in the application that prevent filing and will include the PMA reference number.

(d) If FDA refuses to file the PMA, the applicant may:

(1) Resubmit the PMA with additional information necessary to comply with the requirements of section 515(c)(1) (A)–(G) of the act and § 814.20. A resubmitted PMA shall include the PMA reference number of the original submission. If the resubmitted PMA is accepted for filing, the date of filing is the date FDA receives the resubmission;

(2) Request in writing within 10 working days of the date of receipt of the notice refusing to file the PMA, an informal conference with the Director of the Office of Device Evaluation to review FDA's decision not to file the PMA. FDA will hold the informal conference within 10 working days of its receipt of the request and will render its decision on filing within 5 working days after the informal conference. If, after the informal conference, FDA accepts the PMA for filing, the date of filing will be the date of the decision to accept the PMA for filing. If FDA does not reverse its decision not to file the PMA, the applicant may request reconsideration of the decision from the Director of the Center for Devices and Radiological Health, the Director of the Center for Biologics Evaluation and Research, or the Director of the Center for Drug Evaluation and Research, as applicable. The Director's decision will constitute final administrative action for the purpose of judicial review.

## §814.44

## 21 CFR Ch. I (4–1–20 Edition)

(e) FDA may refuse to file a PMA if any of the following applies:

(1) The application is incomplete because it does not on its face contain all the information required under section 515(c)(1) (A)–(G) of the act;

(2) The PMA does not contain each of the items required under §814.20 and justification for omission of any item is inadequate;

(3) The applicant has a pending pre-market notification under section 510(k) of the act with respect to the same device, and FDA has not determined whether the device falls within the scope of §814.1(c).

(4) The PMA contains a false statement of material fact.

(5) The PMA is not accompanied by a statement of either certification or disclosure as required by part 54 of this chapter.

[51 FR 26364, July 22, 1986, as amended at 63 FR 5254, Feb. 2, 1998; 73 FR 49942, Aug. 25, 2008]

### §814.44 Procedures for review of a PMA.

(a) FDA will begin substantive review of a PMA after the PMA is accepted for filing under §814.42. FDA may refer the PMA to a panel on its own initiative, and will do so upon request of an applicant, unless FDA determines that the application substantially duplicates information previously reviewed by a panel. If FDA refers an application to a panel, FDA will forward the PMA, or relevant portions thereof, to each member of the appropriate FDA panel for review. During the review process, FDA may communicate with the applicant as set forth under §814.37(b), or with a panel to respond to questions that may be posed by panel members or to provide additional information to the panel. FDA will maintain a record of all communications with the applicant and with the panel.

(b) The advisory committee shall submit a report to FDA which includes the committee's recommendation and the basis for such recommendation on the PMA. Before submission of this report, the committee shall hold a public meeting to review the PMA in accordance with part 14. This meeting may be held by a telephone conference under §14.22(g). The advisory committee re-

port and recommendation may be in the form of a meeting transcript signed by the chairperson of the committee.

(c) FDA will complete its review of the PMA and the advisory committee report and recommendation and, within the later of 180 days from the date of filing of the PMA under §814.42 or the number of days after the date of filing as determined under §814.37(c), issue an approval order under paragraph (d) of this section, an approvable letter under paragraph (e) of this section, a not approvable letter under paragraph (f) of this section, or an order denying approval of the application under §814.45(a).

(d)(1) FDA will issue to the applicant an order approving a PMA if none of the reasons in §814.45 for denying approval of the application applies. FDA will approve an application on the basis of draft final labeling if the only deficiencies in the application concern editorial or similar minor deficiencies in the draft final labeling. Such approval will be conditioned upon the applicant incorporating the specified labeling changes exactly as directed and upon the applicant submitting to FDA a copy of the final printed labeling before marketing. FDA will also give the public notice of the order, including notice of and opportunity for any interested persons to request review under section 515(d)(3) of the act. The notice of approval will be placed on FDA's home page on the Internet (<http://www.fda.gov>), and it will state that a detailed summary of information respecting the safety and effectiveness of the device, which was the basis for the order approving the PMA, including information about any adverse effects of the device on health, is available on the Internet and has been placed on public display, and that copies are available upon request. FDA will publish in the FEDERAL REGISTER after each quarter a list of the approvals announced in that quarter. When a notice of approval is published, data and information in the PMA file will be available for public disclosure in accordance with §814.9.

(2) A request for copies of the current PMA approvals and denials document and for copies of summaries of safety

and effectiveness shall be sent in writing to the Division of Dockets Management (HFA-305), Food and Drug Administration, 5630 Fishers Lane, rm. 1061, Rockville, MD 20852.

(e) FDA will send the applicant an approvable letter if the application substantially meets the requirements of this part and the agency believes it can approve the application if specific additional information is submitted or specific conditions are agreed to by the applicant.

(1) The approvable letter will describe the information FDA requires to be provided by the applicant or the conditions the applicant is required to meet to obtain approval. For example, FDA may require, as a condition to approval:

(i) The submission of certain information identified in the approvable letter, e.g., final labeling;

(ii) The submission of additional information concerning pediatric uses required by §814.20(b)(13);

(iii) An FDA inspection that finds the manufacturing facilities, methods, and controls in compliance with part 820 and, if applicable, that verifies records pertinent to the PMA;

(iv) Restrictions imposed on the device under section 515(d)(1)(B)(ii) or 520(e) of the act;

(v) Postapproval requirements as described in subpart E of this part.

(2) In response to an approvable letter the applicant may:

(i) Amend the PMA as requested in the approvable letter; or

(ii) Consider the approvable letter to be a denial of approval of the PMA under §814.45 and request administrative review under section 515(d)(3) of the act by filing a petition in the form of a petition for reconsideration under §10.33; or

(iii) Withdraw the PMA.

(f) FDA will send the applicant a not approvable letter if the agency believes that the application may not be approved for one or more of the reasons given in §814.45(a). The not approvable letter will describe the deficiencies in the application, including each applicable ground for denial under section 515(d)(2) (A)–(E) of the act, and, where practical, will identify measures required to place the PMA in approvable

form. In response to a not approvable letter, the applicant may:

(1) Amend the PMA as requested in the not approvable letter (such an amendment will be considered a major amendment under §814.37(c)(1)); or

(2) Consider the not approvable letter to be a denial of approval of the PMA under §814.45 and request administrative review under section 515(d)(3) of the act by filing a petition in the form of a petition for reconsideration under §10.33; or

(3) Withdraw the PMA.

(g) FDA will consider a PMA to have been withdrawn voluntarily if:

(1) The applicant fails to respond in writing to a written request for an amendment within 180 days after the date FDA issues such request;

(2) The applicant fails to respond in writing to an approvable or not approvable letter within 180 days after the date FDA issues such letter; or

(3) The applicant submits a written notice to FDA that the PMA has been withdrawn.

[51 FR 26364, July 22, 1986, as amended at 57 FR 58403, Dec. 10, 1992; 63 FR 4572, Jan. 30, 1998; 79 FR 1740, Jan. 10, 2014]

#### §814.45 Denial of approval of a PMA.

(a) FDA may issue an order denying approval of a PMA if the applicant fails to follow the requirements of this part or if, upon the basis of the information submitted in the PMA or any other information before the agency, FDA determines that any of the grounds for denying approval of a PMA specified in section 515(d)(2) (A)–(E) of the act applies. In addition, FDA may deny approval of a PMA for any of the following reasons:

(1) The PMA contains a false statement of material fact;

(2) The device's proposed labeling does not comply with the requirements in part 801 or part 809;

(3) The applicant does not permit an authorized FDA employee an opportunity to inspect at a reasonable time and in a reasonable manner the facilities, controls, and to have access to and to copy and verify all records pertinent to the application;

(4) A nonclinical laboratory study that is described in the PMA and that is essential to show that the device is

## §814.46

## 21 CFR Ch. I (4–1–20 Edition)

safe for use under the conditions prescribed, recommended, or suggested in its proposed labeling, was not conducted in compliance with the good laboratory practice regulations in part 58 and no reason for the noncompliance is provided or, if it is, the differences between the practices used in conducting the study and the good laboratory practice regulations do not support the validity of the study; or

(5) Any clinical investigation involving human subjects described in the PMA, subject to the institutional review board regulations in part 56 of this chapter or informed consent regulations in part 50 of this chapter or GCP referenced in §814.15(a) and described in §812.28(a) of this chapter, was not conducted in compliance with those regulations such that the rights or safety of human subjects were not adequately protected or the supporting data were determined to be otherwise unreliable.

(b) FDA will issue any order denying approval of the PMA in accordance with §814.17. The order will inform the applicant of the deficiencies in the PMA, including each applicable ground for denial under section 515(d)(2) of the act and the regulations under this part, and, where practical, will identify measures required to place the PMA in approvable form. The order will include a notice of an opportunity to request review under section 515(d)(4) of the act.

(c) FDA will use the criteria specified in §860.7 to determine the safety and effectiveness of a device in deciding whether to approve or deny approval of a PMA. FDA may use information other than that submitted by the applicant in making such determination.

(d)(1) FDA will give the public notice of an order denying approval of the PMA. The notice will be placed on the FDA's home page on the Internet (<http://www.fda.gov>), and it will state that a detailed summary of information respecting the safety and effectiveness of the device, including information about any adverse effects of the device on health, is available on the Internet and has been placed on public display and that copies are available upon request. FDA will publish in the FEDERAL REGISTER after each quarter a

list of the denials announced in that quarter. When a notice of denial of approval is made publicly available, data and information in the PMA file will be available for public disclosure in accordance with §814.9.

(2) A request for copies of the current PMA approvals and denials document and copies of summaries of safety and effectiveness shall be sent in writing to the Freedom of Information Staff's address listed on the Agency's Web site at <http://www.fda.gov>.

(e) FDA will issue an order denying approval of a PMA after an approvable or not approvable letter has been sent and the applicant:

(1) Submits a requested amendment but any ground for denying approval of the application under section 515(d)(2) of the act still applies; or

(2) Notifies FDA in writing that the requested amendment will not be submitted; or

(3) Petitions for review under section 515(d)(3) of the act by filing a petition in the form of a petition for reconsideration under §10.33.

[51 FR 26364, July 22, 1986, as amended at 63 FR 4572, Jan. 30, 1998; 73 FR 34859, June 19, 2008; 76 FR 31470, June 1, 2011; 79 FR 68115, Nov. 14, 2014; 83 FR 7387, Feb. 21, 2018]

### §814.46 Withdrawal of approval of a PMA.

(a) FDA may issue an order withdrawing approval of a PMA if, from any information available to the agency, FDA determines that:

(1) Any of the grounds under section 515(e)(1) (A)–(G) of the act applies.

(2) Any postapproval requirement imposed by the PMA approval order or by regulation has not been met.

(3) A nonclinical laboratory study that is described in the PMA and that is essential to show that the device is safe for use under the conditions prescribed, recommended, or suggested in its proposed labeling, was not conducted in compliance with the good laboratory practice regulations in part 58 and no reason for the noncompliance is provided or, if it is, the differences between the practices used in conducting the study and the good laboratory practice regulations do not support the validity of the study.

(4) Any clinical investigation involving human subjects described in the PMA, subject to the institutional review board regulations in part 56 of this chapter or informed consent regulations in part 50 of this chapter or GCP referenced in §814.15(a) and described in §812.28(a) of this chapter, was not conducted in compliance with those regulations such that the rights or safety of human subjects were not adequately protected or the supporting data were determined to be otherwise unreliable.

(b)(1) FDA may seek advice on scientific matters from any appropriate FDA advisory committee in deciding whether to withdraw approval of a PMA.

(2) FDA may use information other than that submitted by the applicant in deciding whether to withdraw approval of a PMA.

(c) Before issuing an order withdrawing approval of a PMA, FDA will issue the holder of the approved application a notice of opportunity for an informal hearing under part 16.

(d) If the applicant does not request a hearing or if after the part 16 hearing is held the agency decides to proceed with the withdrawal, FDA will issue to the holder of the approved application an order withdrawing approval of the application. The order will be issued under §814.17, will state each ground for withdrawing approval, and will include a notice of an opportunity for administrative review under section 515(e)(2) of the act.

(e) FDA will give the public notice of an order withdrawing approval of a PMA. The notice will be published in the FEDERAL REGISTER and will state that a detailed summary of information respecting the safety and effectiveness of the device, including information about any adverse effects of the device on health, has been placed on public display and that copies are available upon request. When a notice of withdrawal of approval is published, data and information in the PMA file will be available for public disclosure in accordance with §814.9.

[51 FR 26364, July 22, 1986, as amended at 83 FR 7387, Feb. 21, 2018]

#### § 814.47 Temporary suspension of approval of a PMA.

(a) *Scope.* (1) This section describes the procedures that FDA will follow in exercising its authority under section 515(e)(3) of the act (21 U.S.C. 360e(e)(3)). This authority applies to the original PMA, as well as any PMA supplement(s), for a medical device.

(2) FDA will issue an order temporarily suspending approval of a PMA if FDA determines that there is a reasonable probability that continued distribution of the device would cause serious, adverse health consequences or death.

(b) *Regulatory hearing.* (1) If FDA believes that there is a reasonable probability that the continued distribution of a device subject to an approved PMA would cause serious, adverse health consequences or death, FDA may initiate and conduct a regulatory hearing to determine whether to issue an order temporarily suspending approval of the PMA.

(2) Any regulatory hearing to determine whether to issue an order temporarily suspending approval of a PMA shall be initiated and conducted by FDA pursuant to part 16 of this chapter. If FDA believes that immediate action to remove a dangerous device from the market is necessary to protect the public health, the agency may, in accordance with §16.60(h) of this chapter, waive, suspend, or modify any part 16 procedure pursuant to §10.19 of this chapter.

(3) FDA shall deem the PMA holder's failure to request a hearing within the timeframe specified by FDA in the notice of opportunity for hearing to be a waiver.

(c) *Temporary suspension order.* If the PMA holder does not request a regulatory hearing or if, after the hearing, and after consideration of the administrative record of the hearing, FDA determines that there is a reasonable probability that the continued distribution of a device under an approved PMA would cause serious, adverse health consequences or death, the agency shall, under the authority of section 515(e)(3) of the act, issue an order to the PMA holder temporarily suspending approval of the PMA.

**§ 814.80**

(d) *Permanent withdrawal of approval of the PMA.* If FDA issues an order temporarily suspending approval of a PMA, the agency shall proceed expeditiously, but within 60 days, to hold a hearing on whether to permanently withdraw approval of the PMA in accordance with section 515(e)(1) of the act and the procedures set out in § 814.46.

[61 FR 15190, Apr. 5, 1996]

**Subpart D—Administrative Review  
[Reserved]**

**Subpart E—Postapproval  
Requirements**

**§ 814.80 General.**

A device may not be manufactured, packaged, stored, labeled, distributed, or advertised in a manner that is inconsistent with any conditions to approval specified in the PMA approval order for the device.

**§ 814.82 Postapproval requirements.**

(a) FDA may impose postapproval requirements in a PMA approval order or by regulation at the time of approval of the PMA or by regulation subsequent to approval. Postapproval requirements may include as a condition to approval of the device:

(1) Restriction of the sale, distribution, or use of the device as provided by section 515(d)(1)(B)(ii) or 520(e) of the act.

(2) Continuing evaluation and periodic reporting on the safety, effectiveness, and reliability of the device for its intended use. FDA will state in the PMA approval order the reason or purpose for such requirement and the number of patients to be evaluated and the reports required to be submitted.

(3) Prominent display in the labeling of a device and in the advertising of any restricted device of warnings, hazards, or precautions important for the device's safe and effective use, including patient information, e.g., information provided to the patient on alternative modes of therapy and on risks and benefits associated with the use of the device.

(4) Inclusion of identification codes on the device or its labeling, or in the case of an implant, on cards given to

patients if necessary to protect the public health.

(5) Maintenance of records that will enable the applicant to submit to FDA information needed to trace patients if such information is necessary to protect the public health. Under section 519(a)(4) of the act, FDA will require that the identity of any patient be disclosed in records maintained under this paragraph only to the extent required for the medical welfare of the individual, to determine the safety or effectiveness of the device, or to verify a record, report, or information submitted to the agency.

(6) Maintenance of records for specified periods of time and organization and indexing of records into identifiable files to enable FDA to determine whether there is reasonable assurance of the continued safety and effectiveness of the device.

(7) Submission to FDA at intervals specified in the approval order of periodic reports containing the information required by § 814.84(b).

(8) Batch testing of the device.

(9) Such other requirements as FDA determines are necessary to provide reasonable assurance, or continued reasonable assurance, of the safety and effectiveness of the device.

(b) An applicant shall grant to FDA access to any records and reports required under the provisions of this part, and shall permit authorized FDA employees to copy and verify such records and reports and to inspect at a reasonable time and in a reasonable manner all manufacturing facilities to verify that the device is being manufactured, stored, labeled, and shipped under approved conditions.

(c) Failure to comply with any postapproval requirement constitutes a ground for withdrawal of approval of a PMA.

(Approved by the Office of Management and Budget under control number 0910-0231)

[51 FR 26364, July 22, 1986, as amended at 51 FR 43344, Dec. 2, 1986]

**§ 814.84 Reports.**

(a) The holder of an approved PMA shall comply with the requirements of part 803 and with any other requirements applicable to the device by other



regulations in this subchapter or by order approving the device.

(b) Unless FDA specifies otherwise, any periodic report shall:

(1) Identify changes described in § 814.39(a) and changes required to be reported to FDA under § 814.39(b).

(2) Contain a summary and bibliography of the following information not previously submitted as part of the PMA:

(i) Unpublished reports of data from any clinical investigations or nonclinical laboratory studies involving the device or related devices and known to or that reasonably should be known to the applicant.

(ii) Reports in the scientific literature concerning the device and known to or that reasonably should be known to the applicant. If, after reviewing the summary and bibliography, FDA concludes that the agency needs a copy of the unpublished or published reports, FDA will notify the applicant that copies of such reports shall be submitted.

(3) Identify changes made pursuant to an exception or alternative granted under § 801.128 or § 809.11 of this chapter.

(4) Identify each device identifier currently in use for the device, and each device identifier for the device that has been discontinued since the previous periodic report. It is not necessary to identify any device identifier discontinued prior to December 23, 2013.

[51 FR 26364, July 22, 1986, as amended at 51 FR 43344, Dec. 2, 1986; 67 FR 9587, Mar. 4, 2002; 72 FR 73602, Dec. 28, 2007; 78 FR 58822, Sept. 24, 2013]

### Subparts F–G [Reserved]

### Subpart H—Humanitarian Use Devices

SOURCE: 61 FR 33244, June 26, 1996, unless otherwise noted.

#### § 814.100 Purpose and scope.

(a) This subpart H implements sections 515A and 520(m) of the act.

(b) The purpose of section 520(m) is, to the extent consistent with the protection of the public health and safety and with ethical standards, to encour-

age the discovery and use of devices intended to benefit patients in the treatment or diagnosis of diseases or conditions that affect or are manifested in not more than 8,000 individuals in the United States per year. This subpart provides procedures for obtaining:

(1) HUD designation of a medical device; and

(2) Marketing approval for the HUD notwithstanding the absence of reasonable assurance of effectiveness that would otherwise be required under sections 514 and 515 of the act.

(c) Section 515A of the act is intended to ensure the submission of readily available information concerning:

(1) Any pediatric subpopulations (neonates, infants, children, adolescents) that suffer from the disease or condition that the device is intended to treat, diagnose, or cure; and

(2) The number of affected pediatric patients.

(d) Although a HUD may also have uses that differ from the humanitarian use, applicants seeking approval of any non-HUD use shall submit a PMA as required under § 814.20, or a premarket notification as required under part 807 of this chapter.

(e) Obtaining marketing approval for a HUD involves two steps:

(1) Obtaining designation of the device as a HUD from FDA's Office of Orphan Products Development, and

(2) Submitting an HDE to the Office of Device Evaluation (ODE), Center for Devices and Radiological Health (CDRH), the Center for Biologics Evaluation and Research (CBER), or the Center for Drug Evaluation and Research (CDER), as applicable.

(f) A person granted an exemption under section 520(m) of the act shall submit periodic reports as described in § 814.126(b).

(g) FDA may suspend or withdraw approval of an HDE after providing notice and an opportunity for an informal hearing.

[61 FR 33244, June 26, 1996, as amended at 63 FR 59220, Nov. 3, 1998; 73 FR 49942, Aug. 25, 2008; 79 FR 1740, Jan. 10, 2014; 82 FR 26349, June 7, 2017]

**§ 814.102 Designation of HUD status.**

(a) *Request for designation.* Prior to submitting an HDE application, the applicant shall submit a request for HUD designation to FDA's Office of Orphan Products Development. The request shall contain the following:

(1) A statement that the applicant requests HUD designation for a rare disease or condition or a valid subset of a disease or condition which shall be identified with specificity;

(2) The name and address of the applicant, the name of the applicant's primary contact person and/or resident agent, including title, address, and telephone number;

(3) A description of the rare disease or condition for which the device is to be used, the proposed indication or indications for use of the device, and the reasons why such therapy is needed. If the device is proposed for an indication that represents a subset of a common disease or condition, a demonstration that the subset is medically plausible should be included;

(4) A description of the device and a discussion of the scientific rationale for the use of the device for the rare disease or condition; and

(5) Documentation, with appended authoritative references, to demonstrate that the device is designed to treat or diagnose a disease or condition that affects or is manifested in not more than 8,000 people in the United States per year. If the device is for diagnostic purposes, the documentation must demonstrate that not more than 8,000 patients per year would be subjected to diagnosis by the device in the United States. Authoritative references include literature citations in specialized medical journals, textbooks, specialized medical society proceedings, or governmental statistics publications. When no such studies or literature citations exist, the applicant may be able to demonstrate the prevalence of the disease or condition in the United States by providing credible conclusions from appropriate research or surveys.

(b) *FDA action.* Within 45 days of receipt of a request for HUD designation, FDA will take one of the following actions:

(1) Approve the request and notify the applicant that the device has been designated as a HUD based on the information submitted;

(2) Return the request to the applicant pending further review upon submission of additional information. This action will ensue if the request is incomplete because it does not on its face contain all of the information required under § 814.102(a). Upon receipt of this additional information, the review period may be extended up to 45 days; or

(3) Disapprove the request for HUD designation based on a substantive review of the information submitted. FDA may disapprove a request for HUD designation if:

(i) There is insufficient evidence to support the estimate that the disease or condition for which the device is designed to treat or diagnose affects or is manifested in not more than 8,000 people in the United States per year;

(ii) FDA determines that, for a diagnostic device, more than 8,000 patients in the United States would be subjected to diagnosis using the device per year; or

(iii) FDA determines that the patient population defined in the request is not a medically plausible subset of a larger population.

(c) *Revocation of designation.* FDA may revoke a HUD designation if the agency finds that:

(1) The request for designation contained an untrue statement of material fact or omitted material information; or

(2) Based on the evidence available, the device is not eligible for HUD designation.

(d) *Submission.* The applicant shall submit two copies of a completed, dated, and signed request for HUD designation to: Office of Orphan Products Development (HF-35), Food and Drug Administration, 5600 Fishers Lane, Rockville, MD 20857.

[61 FR 33244, June 26, 1996, as amended at 82 FR 26349, June 7, 2017]

**§ 814.104 Original applications.**

(a) *United States applicant or representative.* The applicant or an authorized representative shall sign the HDE. If the applicant does not reside or have a place of business within the United

States, the HDE shall be countersigned by an authorized representative residing or maintaining a place of business in the United States and shall identify the representative's name and address.

(b) *Contents.* Unless the applicant justifies an omission in accordance with paragraph (d) of this section, an HDE shall include:

(1) A copy of or reference to the determination made by FDA's Office of Orphan Products Development (in accordance with §814.102) that the device qualifies as a HUD;

(2) An explanation of why the device would not be available unless an HDE were granted and a statement that no comparable device (other than another HUD approved under this subpart or a device under an approved IDE) is available to treat or diagnose the disease or condition. The application also shall contain a discussion of the risks and benefits of currently available devices or alternative forms of treatment in the United States;

(3) An explanation of why the probable benefit to health from the use of the device outweighs the risk of injury or illness from its use, taking into account the probable risks and benefits of currently available devices or alternative forms of treatment. Such explanation shall include a description, explanation, or theory of the underlying disease process or condition, and known or postulated mechanism(s) of action of the device in relation to the disease process or condition;

(4) All of the information required to be submitted under §814.20(b), except that:

(i) In lieu of the summaries, conclusions, and results from clinical investigations required under §814.20(b)(3)(v)(B), (b)(3)(vi), and the introductory text of (b)(6)(ii), the applicant shall include the summaries, conclusions, and results of all clinical experience or investigations (whether adverse or supportive) reasonably obtainable by the applicant that are relevant to an assessment of the risks and probable benefits of the device and to the extent the applicant includes data from clinical investigations, the applicant shall include the statements described in §814.20(b)(6)(ii)(A) and (B) with respect to clinical investigations con-

ducted in the United States and the information described in §814.20(b)(6)(ii)(C) with respect to clinical investigations conducted outside the United States; and

(ii) In addition to the proposed labeling requirement set forth in §814.20(b)(10), the labeling shall bear the following statement: Humanitarian Device. Authorized by Federal law for use in the [treatment or diagnosis] of [specify disease or condition]. The effectiveness of this device for this use has not been demonstrated;

(5) The amount to be charged for the device and, if the amount is more than \$250, a report by an independent certified public accountant, made in accordance with the Statement on Standards for Attestation established by the American Institute of Certified Public Accountants, or in lieu of such a report, an attestation by a responsible individual of the organization, verifying that the amount charged does not exceed the costs of the device's research, development, fabrication, and distribution. If the amount charged is \$250 or less, the requirement for a report by an independent certified public accountant or an attestation by a responsible individual of the organization is waived; and

(6) Information concerning pediatric uses of the device, as required by §814.20(b)(13).

(c) *Omission of information.* If the applicant believes that certain information required under paragraph (b) of this section is not applicable to the device that is the subject of the HDE, and omits any such information from its HDE, the applicant shall submit a statement that identifies and justifies the omission. The statement shall be submitted as a separate section in the HDE and identified in the table of contents. If the justification for the omission is not accepted by the agency, FDA will so notify the applicant.

(d) *Address for submissions and correspondence.* All original HDEs, amendments and supplements, as well as any correspondence relating to an HDE, must be provided in electronic format. These materials must be sent or delivered to one of the following:

(1) For devices regulated by the Center for Devices and Radiological

## §814.106

Health, send it to the current address found on the website <https://www.fda.gov/cdrhsubmissionaddress>.

(2) For devices regulated by the Center for Biologics Evaluation and Research, send it to the current address displayed on the website <https://www.fda.gov/AboutFDA/CentersOffices/OfficeofMedicalProductsandTobacco/CBER/ucm385240.htm>.

(3) For devices regulated by the Center for Drug Evaluation and Research, send this information to the Central Document Control Room, Center for Drug Evaluation and Research, Food and Drug Administration, 5901-B Ammendale Rd., Beltsville, MD 20705-1266.

[61 FR 33244, June 26, 1996, as amended at 63 FR 59220, Nov. 3, 1998; 73 FR 49942, Aug. 25, 2008; 75 FR 20915, Apr. 22, 2010; 79 FR 1740, Jan. 10, 2014; 80 FR 18094, Apr. 3, 2015; 83 FR 7388, Feb. 21, 2018; 84 FR 68340, Dec. 16, 2019]

### §814.106 HDE amendments and resubmitted HDE's.

An HDE or HDE supplement may be amended or resubmitted upon an applicant's own initiative, or at the request of FDA, for the same reasons and in the same manner as prescribed for PMA's in §814.37, except that the timeframes set forth in §814.37(c)(1) and (d) do not apply. If FDA requests an HDE applicant to submit an HDE amendment, and a written response to FDA's request is not received within 75 days of the date of the request, FDA will consider the pending HDE or HDE supplement to be withdrawn voluntarily by the applicant. Furthermore, if the HDE applicant, on its own initiative or at FDA's request, submits a major amendment as described in §814.37(c)(1), the review period may be extended up to 75 days.

[63 FR 59220, Nov. 3, 1998]

### §814.108 Supplemental applications.

After FDA approval of an original HDE, an applicant shall submit supplements in accordance with the requirements for PMA's under §814.39, except that a request for a new indication for use of a HUD shall comply with requirements set forth in §814.110. The timeframes for review of, and FDA action on, an HDE supplement are the

## 21 CFR Ch. I (4-1-20 Edition)

same as those provided in §814.114 for an HDE.

[63 FR 59220, Nov. 3, 1998]

### §814.110 New indications for use.

(a) An applicant seeking a new indication for use of a HUD approved under this subpart H shall obtain a new designation of HUD status in accordance with §814.102 and shall submit an original HDE in accordance with §814.104.

(b) An application for a new indication for use made under §814.104 may incorporate by reference any information or data previously submitted to the agency under an HDE.

### §814.112 Filing an HDE.

(a) The filing of an HDE means that FDA has made a threshold determination that the application is sufficiently complete to permit substantive review. Within 30 days from the date an HDE is received by FDA, the agency will notify the applicant whether the application has been filed. FDA may refuse to file an HDE if any of the following applies:

(1) The application is incomplete because it does not on its face contain all the information required under §814.104(b);

(2) FDA determines that there is a comparable device available (other than another HUD approved under this subpart or a device under an approved IDE) to treat or diagnose the disease or condition for which approval of the HUD is being sought; or

(3) The application contains an untrue statement of material fact or omits material information.

(4) The HDE is not accompanied by a statement of either certification or disclosure, or both, as required by part 54 of this chapter.

(b) The provisions contained in §814.42(b), (c), and (d) regarding notification of filing decisions, filing dates, the start of the 75-day review period, and applicant's options in response to FDA refuse to file decisions shall apply to HDE's.

[61 FR 33244, June 26, 1996, as amended at 63 FR 5254, Feb. 2, 1998; 63 FR 59221, Nov. 3, 1998]

**§ 814.114 Timeframes for reviewing an HDE.**

Within 75 days after receipt of an HDE that is accepted for filing and to which the applicant does not submit a major amendment, FDA shall send the applicant an approval order, an approvable letter, a not approvable letter (under § 814.116), or an order denying approval (under § 814.118).

[63 FR 59221, Nov. 3, 1998]

**§ 814.116 Procedures for review of an HDE.**

(a) *Substantive review.* FDA will begin substantive review of an HDE after the HDE is accepted for filing under § 814.112. FDA may refer an original HDE application to a panel on its own initiative, and shall do so upon the request of an applicant, unless FDA determines that the application substantially duplicates information previously reviewed by a panel. If the HDE is referred to a panel, the agency shall follow the procedures set forth under § 814.44, with the exception that FDA will complete its review of the HDE and the advisory committee report and recommendations within 75 days from receipt of an HDE that is accepted for filing under § 814.112 or the date of filing as determined under § 814.106, whichever is later. Within the later of these two timeframes, FDA will issue an approval order under paragraph (b) of this section, an approvable letter under paragraph (c) of this section, a not approvable letter under paragraph (d) of this section, or an order denying approval of the application under § 814.118(a).

(b) *Approval order.* FDA will issue to the applicant an order approving an HDE if none of the reasons in § 814.118 for denying approval of the application applies. FDA will approve an application on the basis of draft final labeling if the only deficiencies in the application concern editorial or similar minor deficiencies in the draft final labeling. Such approval will be conditioned upon the applicant incorporating the specified labeling changes exactly as directed and upon the applicant submitting to FDA a copy of the final printed labeling before marketing. The notice of approval of an HDE will be published

in the FEDERAL REGISTER in accordance with the rules and policies applicable to PMA's submitted under § 814.20. Following the issuance of an approval order, data and information in the HDE file will be available for public disclosure in accordance with § 814.9(b) through (h), as applicable.

(c) *Approvable letter.* FDA will send the applicant an approvable letter if the application substantially meets the requirements of this subpart and the agency believes it can approve the application if specific additional information is submitted or specific conditions are agreed to by the applicant. The approvable letter will describe the information FDA requires to be provided by the applicant or the conditions the applicant is required to meet to obtain approval. For example, FDA may require as a condition to approval:

(1) The submission of certain information identified in the approvable letter, e.g., final labeling;

(2) The submission of additional information concerning pediatric uses of the device, as required by § 814.20(b)(13);

(3) Restrictions imposed on the device under section 520(e) of the act;

(4) Postapproval requirements as described in subpart E of this part; and

(5) An FDA inspection that finds the manufacturing facilities, methods, and controls in compliance with part 820 of this chapter and, if applicable, that verifies records pertinent to the HDE.

(d) *Not approvable letter.* FDA will send the applicant a not approvable letter if the agency believes that the application may not be approved for one or more of the reasons given in § 814.118. The not approvable letter will describe the deficiencies in the application and, where practical, will identify measures required to place the HDE in approvable form. The applicant may respond to the not approvable letter in the same manner as permitted for not approvable letters for PMA's under § 814.44(f), with the exception that if a major HDE amendment is submitted, the review period may be extended up to 75 days.

(e) FDA will consider an HDE to have been withdrawn voluntarily if:

(1) The applicant fails to respond in writing to a written request for an

## §814.118

## 21 CFR Ch. I (4–1–20 Edition)

amendment within 75 days after the date FDA issues such request;

(2) The applicant fails to respond in writing to an approvable or not approvable letter within 75 days after the date FDA issues such letter; or

(3) The applicant submits a written notice to FDA that the HDE has been withdrawn.

[61 FR 33244, June 26, 1996, as amended at 63 FR 59221, Nov. 3, 1998; 79 FR 1741, Jan. 10, 2014]

### §814.118 Denial of approval or withdrawal of approval of an HDE.

(a) FDA may deny approval or withdraw approval of an application if the applicant fails to meet the requirements of section 520(m) of the act or of this part, or of any condition of approval imposed by an IRB or by FDA, or any postapproval requirements imposed under §814.126. In addition, FDA may deny approval or withdraw approval of an application if, upon the basis of the information submitted in the HDE or any other information before the agency, FDA determines that:

(1) There is a lack of a showing of reasonable assurance that the device is safe under the conditions of use prescribed, recommended, or suggested in the labeling thereof;

(2) The device is ineffective under the conditions of use prescribed, recommended, or suggested in the labeling thereof;

(3) The applicant has not demonstrated that there is a reasonable basis from which to conclude that the probable benefit to health from the use of the device outweighs the risk of injury or illness, taking into account the probable risks and benefits of currently available devices or alternative forms of treatment;

(4) The application or a report submitted by or on behalf of the applicant contains an untrue statement of material fact, or omits material information;

(5) The device's labeling does not comply with the requirements in part 801 or part 809 of this chapter;

(6) A nonclinical laboratory study that is described in the HDE and that is essential to show that the device is safe for use under the conditions prescribed, recommended, or suggested in

its proposed labeling, was not conducted in compliance with the good laboratory practice regulations in part 58 of this chapter and no reason for the noncompliance is provided or, if it is, the differences between the practices used in conducting the study and the good laboratory practice regulations do not support the validity of the study;

(7) Any clinical investigation involving human subjects described in the HDE, subject to the institutional review board regulations in part 56 of this chapter or the informed consent regulations in part 50 of this chapter, was not conducted in compliance with those regulations such that the rights or safety of human subjects were not adequately protected;

(8) The applicant does not permit an authorized FDA employee an opportunity to inspect at a reasonable time and in a reasonable manner the facilities and controls, and to have access to and to copy and verify all records pertinent to the application; or

(9) The device's HUD designation should be revoked in accordance with §814.102(c).

(b) If FDA issues an order denying approval of an application, the agency will comply with the same notice and disclosure provisions required for PMA's under §814.45(b) and (d), as applicable.

(c) FDA will issue an order denying approval of an HDE after an approvable or not approvable letter has been sent and the applicant:

(1) Submits a requested amendment but any ground for denying approval of the application under §814.118(a) still applies;

(2) Notifies FDA in writing that the requested amendment will not be submitted; or

(3) Petitions for review under section 515(d)(3) of the act by filing a petition in the form of a petition for reconsideration under §10.33 of this chapter.

(d) Before issuing an order withdrawing approval of an HDE, FDA will provide the applicant with notice and an opportunity for a hearing as required for PMA's under §814.46(c) and

(d), and will provide the public with notice in accordance with § 814.46(e), as applicable.

[61 FR 33244, June 26, 1996, as amended at 63 FR 59221, Nov. 3, 1998]

**§ 814.120 Temporary suspension of approval of an HDE.**

An HDE or HDE supplement may be temporarily suspended for the same reasons and in the same manner as prescribed for PMA's in § 814.47.

[63 FR 59221, Nov. 3, 1998]

**§ 814.122 Confidentiality of data and information.**

(a) *Requirement for disclosure.* The "HDE file" includes all data and information submitted with or referenced in the HDE, any IDE incorporated into the HDE, any HDE amendment or supplement, any report submitted under § 814.126, any master file, or any other related submission. Any record in the HDE file will be available for public disclosure in accordance with the provisions of this section and part 20 of this chapter.

(b) *Extent of disclosure.* Disclosure by FDA of the existence and contents of an HDE file shall be subject to the same rules that pertain to PMA's under § 814.9(b) through (h), as applicable.

**§ 814.124 Institutional Review Board requirements.**

(a) *IRB approval.* The HDE holder is responsible for ensuring that a HUD approved under this subpart is administered only in facilities having oversight by an Institutional Review Board (IRB) constituted and acting pursuant to part 56 of this chapter, including continuing review of use of the device. In addition, a HUD may be administered only if such use has been approved by an IRB. If, however, a physician in an emergency situation determines that approval from an IRB cannot be obtained in time to prevent serious harm or death to a patient, a HUD may be administered without prior approval by an IRB. In such an emergency situation, the physician shall, within 5 days after the use of the device, provide written notification to the chairman of the IRB of such use.

Such written notification shall include the identification of the patient involved, the date on which the device was used, and the reason for the use.

(b) *Withdrawal of IRB approval.* A holder of an approved HDE shall notify FDA of any withdrawal of approval for the use of a HUD by a reviewing IRB within 5 working days after being notified of the withdrawal of approval.

[61 FR 33244, June 26, 1996, as amended at 63 FR 59221, Nov. 3, 1998; 82 FR 26349, June 7, 2017]

**§ 814.126 Postapproval requirements and reports.**

(a) An HDE approved under this subpart H shall be subject to the postapproval requirements and reports set forth under subpart E of this part, as applicable, with the exception of § 814.82(a)(7). In addition, medical device reports submitted to FDA in compliance with the requirements of part 803 of this chapter shall also be submitted to the IRB of record.

(b) In addition to the reports identified in paragraph (a) of this section, the holder of an approved HDE shall prepare and submit the following complete, accurate, and timely reports:

(1) *Periodic reports.* An HDE applicant is required to submit reports in accordance with the approval order. Unless FDA specifies otherwise, any periodic report shall include:

(i) An update of the information required under § 814.102(a) in a separately bound volume;

(ii) An update of the information required under § 814.104(b)(2), (b)(3), and (b)(5);

(iii) The number of devices that have been shipped or sold since initial marketing approval under this subpart H and, if the number shipped or sold exceeds 8,000, an explanation and estimate of the number of devices used per patient. If a single device is used on multiple patients, the applicant shall submit an estimate of the number of patients treated or diagnosed using the device together with an explanation of the basis for the estimate;

(iv) Information describing the applicant's clinical experience with the device since the HDE was initially approved. This information shall include safety information that is known or

reasonably should be known to the applicant, medical device reports made under part 803 of this chapter, any data generated from the postmarketing studies, and information (whether published or unpublished) that is known or reasonably expected to be known by the applicant that may affect an evaluation of the safety of the device or that may affect the statement of contraindications, warnings, precautions, and adverse reactions in the device's labeling; and

(v) A summary of any changes made to the device in accordance with supplements submitted under §814.108. If information provided in the periodic reports, or any other information in the possession of FDA, gives the agency reason to believe that a device raises public health concerns or that the criteria for exemption are no longer met, the agency may require the HDE holder to submit additional information to demonstrate continued compliance with the HDE requirements.

(2) *Other.* An HDE holder shall maintain records of the names and addresses of the facilities to which the HUD has been shipped, correspondence with reviewing IRB's, as well as any other information requested by a reviewing IRB or FDA. Such records shall be maintained in accordance with the HDE approval order.

[61 FR 33244, June 26, 1996, as amended at 63 FR 59221, Nov. 3, 1998; 71 FR 16228, Mar. 31, 2006; 82 FR 26349, June 7, 2017]

## PART 820—QUALITY SYSTEM REGULATION

### Subpart A—General Provisions

Sec.  
820.1 Scope.  
820.3 Definitions.  
820.5 Quality system.

### Subpart B—Quality System Requirements

820.20 Management responsibility.  
820.22 Quality audit.  
820.25 Personnel.

### Subpart C—Design Controls

820.30 Design controls.

### Subpart D—Document Controls

820.40 Document controls.

### Subpart E—Purchasing Controls

820.50 Purchasing controls.

### Subpart F—Identification and Traceability

820.60 Identification.  
820.65 Traceability.

### Subpart G—Production and Process Controls

820.70 Production and process controls.  
820.72 Inspection, measuring, and test equipment.  
820.75 Process validation.

### Subpart H—Acceptance Activities

820.80 Receiving, in-process, and finished device acceptance.  
820.86 Acceptance status.

### Subpart I—Nonconforming Product

820.90 Nonconforming product.

### Subpart J—Corrective and Preventive Action

820.100 Corrective and preventive action.

### Subpart K—Labeling and Packaging Control

820.120 Device labeling.  
820.130 Device packaging.

### Subpart L—Handling, Storage, Distribution, and Installation

820.140 Handling.  
820.150 Storage.  
820.160 Distribution.  
820.170 Installation.

### Subpart M—Records

820.180 General requirements.  
820.181 Device master record.  
820.184 Device history record.  
820.186 Quality system record.  
820.198 Complaint files.

### Subpart N—Servicing

820.200 Servicing.

### Subpart O—Statistical Techniques

820.250 Statistical techniques.

AUTHORITY: 21 U.S.C. 351, 352, 360, 360c, 360d, 360e, 360h, 360i, 360j, 360l, 371, 374, 381, 383; 42 U.S.C. 216, 262, 263a, 264.

SOURCE: 61 FR 52654, Oct. 7, 1996, unless otherwise noted.



**Subpart A—General Provisions****§ 820.1 Scope.**

(a) *Applicability.* (1) Current good manufacturing practice (CGMP) requirements are set forth in this quality system regulation. The requirements in this part govern the methods used in, and the facilities and controls used for, the design, manufacture, packaging, labeling, storage, installation, and servicing of all finished devices intended for human use. The requirements in this part are intended to ensure that finished devices will be safe and effective and otherwise in compliance with the Federal Food, Drug, and Cosmetic Act (the act). This part establishes basic requirements applicable to manufacturers of finished medical devices. If a manufacturer engages in only some operations subject to the requirements in this part, and not in others, that manufacturer need only comply with those requirements applicable to the operations in which it is engaged. With respect to class I devices, design controls apply only to those devices listed in § 820.30(a)(2). This regulation does not apply to manufacturers of components or parts of finished devices, but such manufacturers are encouraged to use appropriate provisions of this regulation as guidance. Manufacturers of blood and blood components used for transfusion or for further manufacturing are not subject to this part, but are subject to subchapter F of this chapter. Manufacturers of human cells, tissues, and cellular and tissue-based products (HCT/Ps), as defined in § 1271.3(d) of this chapter, that are medical devices (subject to pre-market review or notification, or exempt from notification, under an application submitted under the device provisions of the act or under a biological product license application under section 351 of the Public Health Service Act) are subject to this part and are also subject to the donor-eligibility procedures set forth in part 1271 subpart C of this chapter and applicable current good tissue practice procedures in part 1271 subpart D of this chapter. In the event of a conflict between applicable regulations in part 1271 and in other parts of this chapter, the regulation specifically applicable to the de-

vice in question shall supersede the more general.

(2) The provisions of this part shall be applicable to any finished device as defined in this part, intended for human use, that is manufactured, imported, or offered for import in any State or Territory of the United States, the District of Columbia, or the Commonwealth of Puerto Rico.

(3) In this regulation the term “where appropriate” is used several times. When a requirement is qualified by “where appropriate,” it is deemed to be “appropriate” unless the manufacturer can document justification otherwise. A requirement is “appropriate” if nonimplementation could reasonably be expected to result in the product not meeting its specified requirements or the manufacturer not being able to carry out any necessary corrective action.

(b) The quality system regulation in this part supplements regulations in other parts of this chapter except where explicitly stated otherwise. In the event of a conflict between applicable regulations in this part and in other parts of this chapter, the regulations specifically applicable to the device in question shall supersede any other generally applicable requirements.

(c) *Authority.* Part 820 is established and issued under authority of sections 501, 502, 510, 513, 514, 515, 518, 519, 520, 522, 701, 704, 801, 803 of the act (21 U.S.C. 351, 352, 360, 360c, 360d, 360e, 360h, 360i, 360j, 360l, 371, 374, 381, 383). The failure to comply with any applicable provision in this part renders a device adulterated under section 501(h) of the act. Such a device, as well as any person responsible for the failure to comply, is subject to regulatory action.

(d) *Foreign manufacturers.* If a manufacturer who offers devices for import into the United States refuses to permit or allow the completion of a Food and Drug Administration (FDA) inspection of the foreign facility for the purpose of determining compliance with this part, it shall appear for purposes of section 801(a) of the act, that the methods used in, and the facilities and controls used for, the design, manufacture, packaging, labeling, storage, installation, or servicing of any devices

### § 820.3

### 21 CFR Ch. I (4–1–20 Edition)

produced at such facility that are offered for import into the United States do not conform to the requirements of section 520(f) of the act and this part and that the devices manufactured at that facility are adulterated under section 501(h) of the act.

(e) *Exemptions or variances.* (1) Any person who wishes to petition for an exemption or variance from any device quality system requirement is subject to the requirements of section 520(f)(2) of the act. Petitions for an exemption or variance shall be submitted according to the procedures set forth in §10.30 of this chapter, the FDA's administrative procedures. Guidance is available from the Food and Drug Administration, Center for Devices and Radiological Health, Division of Small Manufacturers, International and Consumer Assistance, 10903 New Hampshire Ave., Bldg. 66, rm. 4613, Silver Spring, MD 20993-0002, 1-800-638-2041 or 301-796-7100, FAX: 301-847-8149.

(2) FDA may initiate and grant a variance from any device quality system requirement when the agency determines that such variance is in the best interest of the public health. Such variance will remain in effect only so long as there remains a public health need for the device and the device would not likely be made sufficiently available without the variance.

[61 FR 52654, Oct. 7, 1996, as amended at 65 FR 17136, Mar. 31, 2000; 65 FR 66636, Nov. 7, 2000; 69 FR 29829, May 25, 2005; 72 FR 17399, Apr. 9, 2007; 75 FR 20915, Apr. 22, 2010; 80 FR 29906, May 22, 2015]

#### § 820.3 Definitions.

(a) *Act* means the Federal Food, Drug, and Cosmetic Act, as amended (secs. 201–903, 52 Stat. 1040 *et seq.*, as amended (21 U.S.C. 321–394)). All definitions in section 201 of the act shall apply to the regulations in this part.

(b) *Complaint* means any written, electronic, or oral communication that alleges deficiencies related to the identity, quality, durability, reliability, safety, effectiveness, or performance of a device after it is released for distribution.

(c) *Component* means any raw material, substance, piece, part, software, firmware, labeling, or assembly which

is intended to be included as part of the finished, packaged, and labeled device.

(d) *Control number* means any distinctive symbols, such as a distinctive combination of letters or numbers, or both, from which the history of the manufacturing, packaging, labeling, and distribution of a unit, lot, or batch of finished devices can be determined.

(e) *Design history file (DHF)* means a compilation of records which describes the design history of a finished device.

(f) *Design input* means the physical and performance requirements of a device that are used as a basis for device design.

(g) *Design output* means the results of a design effort at each design phase and at the end of the total design effort. The finished design output is the basis for the device master record. The total finished design output consists of the device, its packaging and labeling, and the device master record.

(h) *Design review* means a documented, comprehensive, systematic examination of a design to evaluate the adequacy of the design requirements, to evaluate the capability of the design to meet these requirements, and to identify problems.

(i) *Device history record (DHR)* means a compilation of records containing the production history of a finished device.

(j) *Device master record (DMR)* means a compilation of records containing the procedures and specifications for a finished device.

(k) *Establish* means define, document (in writing or electronically), and implement.

(l) *Finished device* means any device or accessory to any device that is suitable for use or capable of functioning, whether or not it is packaged, labeled, or sterilized.

(m) *Lot or batch* means one or more components or finished devices that consist of a single type, model, class, size, composition, or software version that are manufactured under essentially the same conditions and that are intended to have uniform characteristics and quality within specified limits.

(n) *Management with executive responsibility* means those senior employees of a manufacturer who have the authority to establish or make changes to the

manufacturer's quality policy and quality system.

(o) *Manufacturer* means any person who designs, manufactures, fabricates, assembles, or processes a finished device. Manufacturer includes but is not limited to those who perform the functions of contract sterilization, installation, relabeling, remanufacturing, repackaging, or specification development, and initial distributors of foreign entities performing these functions.

(p) *Manufacturing material* means any material or substance used in or used to facilitate the manufacturing process, a concomitant constituent, or a byproduct constituent produced during the manufacturing process, which is present in or on the finished device as a residue or impurity not by design or intent of the manufacturer.

(q) *Nonconformity* means the non-fulfillment of a specified requirement.

(r) *Product* means components, manufacturing materials, in-process devices, finished devices, and returned devices.

(s) *Quality* means the totality of features and characteristics that bear on the ability of a device to satisfy fitness-for-use, including safety and performance.

(t) *Quality audit* means a systematic, independent examination of a manufacturer's quality system that is performed at defined intervals and at sufficient frequency to determine whether both quality system activities and the results of such activities comply with quality system procedures, that these procedures are implemented effectively, and that these procedures are suitable to achieve quality system objectives.

(u) *Quality policy* means the overall intentions and direction of an organization with respect to quality, as established by management with executive responsibility.

(v) *Quality system* means the organizational structure, responsibilities, procedures, processes, and resources for implementing quality management.

(w) *Remanufacturer* means any person who processes, conditions, renovates, repackages, restores, or does any other act to a finished device that significantly changes the finished device's

performance or safety specifications, or intended use.

(x) *Rework* means action taken on a nonconforming product so that it will fulfill the specified DMR requirements before it is released for distribution.

(y) *Specification* means any requirement with which a product, process, service, or other activity must conform.

(z) *Validation* means confirmation by examination and provision of objective evidence that the particular requirements for a specific intended use can be consistently fulfilled.

(1) *Process validation* means establishing by objective evidence that a process consistently produces a result or product meeting its predetermined specifications.

(2) *Design validation* means establishing by objective evidence that device specifications conform with user needs and intended use(s).

(aa) *Verification* means confirmation by examination and provision of objective evidence that specified requirements have been fulfilled.

(bb) *Human cell, tissue, or cellular or tissue-based product (HCT/P) regulated as a device* means an HCT/P as defined in §1271.3(d) of this chapter that does not meet the criteria in §1271.10(a) and that is also regulated as a device.

(cc) *Unique device identifier (UDI)* means an identifier that adequately identifies a device through its distribution and use by meeting the requirements of §830.20 of this chapter. A unique device identifier is composed of:

(1) A *device identifier*—a mandatory, fixed portion of a UDI that identifies the specific version or model of a device and the labeler of that device; and

(2) A *production identifier*—a conditional, variable portion of a UDI that identifies one or more of the following when included on the label of the device:

(i) The lot or batch within which a device was manufactured;

(ii) The serial number of a specific device;

(iii) The expiration date of a specific device;

(iv) The date a specific device was manufactured.

## § 820.5

## 21 CFR Ch. I (4–1–20 Edition)

(v) For an HCT/P regulated as a device, the distinct identification code required by § 1271.290(c) of this chapter.

(dd) *Universal product code (UPC)* means the product identifier used to identify an item sold at retail in the United States.

[61 FR 52654, Oct. 7, 1996, as amended at 78 FR 58822, Sept. 24, 2013]

### § 820.5 Quality system.

Each manufacturer shall establish and maintain a quality system that is appropriate for the specific medical device(s) designed or manufactured, and that meets the requirements of this part.

### Subpart B—Quality System Requirements

#### § 820.20 Management responsibility.

(a) *Quality policy.* Management with executive responsibility shall establish its policy and objectives for, and commitment to, quality. Management with executive responsibility shall ensure that the quality policy is understood, implemented, and maintained at all levels of the organization.

(b) *Organization.* Each manufacturer shall establish and maintain an adequate organizational structure to ensure that devices are designed and produced in accordance with the requirements of this part.

(1) *Responsibility and authority.* Each manufacturer shall establish the appropriate responsibility, authority, and interrelation of all personnel who manage, perform, and assess work affecting quality, and provide the independence and authority necessary to perform these tasks.

(2) *Resources.* Each manufacturer shall provide adequate resources, including the assignment of trained personnel, for management, performance of work, and assessment activities, including internal quality audits, to meet the requirements of this part.

(3) *Management representative.* Management with executive responsibility shall appoint, and document such appointment of, a member of management who, irrespective of other responsibilities, shall have established authority over and responsibility for:

(i) Ensuring that quality system requirements are effectively established and effectively maintained in accordance with this part; and

(ii) Reporting on the performance of the quality system to management with executive responsibility for review.

(c) *Management review.* Management with executive responsibility shall review the suitability and effectiveness of the quality system at defined intervals and with sufficient frequency according to established procedures to ensure that the quality system satisfies the requirements of this part and the manufacturer's established quality policy and objectives. The dates and results of quality system reviews shall be documented.

(d) *Quality planning.* Each manufacturer shall establish a quality plan which defines the quality practices, resources, and activities relevant to devices that are designed and manufactured. The manufacturer shall establish how the requirements for quality will be met.

(e) *Quality system procedures.* Each manufacturer shall establish quality system procedures and instructions. An outline of the structure of the documentation used in the quality system shall be established where appropriate.

#### § 820.22 Quality audit.

Each manufacturer shall establish procedures for quality audits and conduct such audits to assure that the quality system is in compliance with the established quality system requirements and to determine the effectiveness of the quality system. Quality audits shall be conducted by individuals who do not have direct responsibility for the matters being audited. Corrective action(s), including a reaudit of deficient matters, shall be taken when necessary. A report of the results of each quality audit, and reaudit(s) where taken, shall be made and such reports shall be reviewed by management having responsibility for the matters audited. The dates and results of quality audits and reaudits shall be documented.

§ 820.25 Personnel.

(a) *General.* Each manufacturer shall have sufficient personnel with the necessary education, background, training, and experience to assure that all activities required by this part are correctly performed.

(b) *Training.* Each manufacturer shall establish procedures for identifying training needs and ensure that all personnel are trained to adequately perform their assigned responsibilities. Training shall be documented.

(1) As part of their training, personnel shall be made aware of device defects which may occur from the improper performance of their specific jobs.

(2) Personnel who perform verification and validation activities shall be made aware of defects and errors that may be encountered as part of their job functions.

**Subpart C—Design Controls**

§ 820.30 Design controls.

(a) *General.* (1) Each manufacturer of any class III or class II device, and the class I devices listed in paragraph (a)(2) of this section, shall establish and maintain procedures to control the design of the device in order to ensure that specified design requirements are met.

(2) The following class I devices are subject to design controls:

(i) Devices automated with computer software; and

(ii) The devices listed in the following chart.

Section	Device
868.6810 .....	Catheter, Tracheobronchial Suction.
878.4460 .....	Glove, Surgeon's.
880.6760 .....	Restraint, Protective.
892.5650 .....	System, Applicator, Radionuclide, Manual.
892.5740 .....	Source, Radionuclide Teletherapy.

(b) *Design and development planning.* Each manufacturer shall establish and maintain plans that describe or reference the design and development activities and define responsibility for implementation. The plans shall identify and describe the interfaces with different groups or activities that provide, or result in, input to the design and development process. The plans

shall be reviewed, updated, and approved as design and development evolves.

(c) *Design input.* Each manufacturer shall establish and maintain procedures to ensure that the design requirements relating to a device are appropriate and address the intended use of the device, including the needs of the user and patient. The procedures shall include a mechanism for addressing incomplete, ambiguous, or conflicting requirements. The design input requirements shall be documented and shall be reviewed and approved by a designated individual(s). The approval, including the date and signature of the individual(s) approving the requirements, shall be documented.

(d) *Design output.* Each manufacturer shall establish and maintain procedures for defining and documenting design output in terms that allow an adequate evaluation of conformance to design input requirements. Design output procedures shall contain or make reference to acceptance criteria and shall ensure that those design outputs that are essential for the proper functioning of the device are identified. Design output shall be documented, reviewed, and approved before release. The approval, including the date and signature of the individual(s) approving the output, shall be documented.

(e) *Design review.* Each manufacturer shall establish and maintain procedures to ensure that formal documented reviews of the design results are planned and conducted at appropriate stages of the device's design development. The procedures shall ensure that participants at each design review include representatives of all functions concerned with the design stage being reviewed and an individual(s) who does not have direct responsibility for the design stage being reviewed, as well as any specialists needed. The results of a design review, including identification of the design, the date, and the individual(s) performing the review, shall be documented in the design history file (the DHF).

(f) *Design verification.* Each manufacturer shall establish and maintain procedures for verifying the device design. Design verification shall confirm that the design output meets the design

input requirements. The results of the design verification, including identification of the design, method(s), the date, and the individual(s) performing the verification, shall be documented in the DHF.

(g) *Design validation.* Each manufacturer shall establish and maintain procedures for validating the device design. Design validation shall be performed under defined operating conditions on initial production units, lots, or batches, or their equivalents. Design validation shall ensure that devices conform to defined user needs and intended uses and shall include testing of production units under actual or simulated use conditions. Design validation shall include software validation and risk analysis, where appropriate. The results of the design validation, including identification of the design, method(s), the date, and the individual(s) performing the validation, shall be documented in the DHF.

(h) *Design transfer.* Each manufacturer shall establish and maintain procedures to ensure that the device design is correctly translated into production specifications.

(i) *Design changes.* Each manufacturer shall establish and maintain procedures for the identification, documentation, validation or where appropriate verification, review, and approval of design changes before their implementation.

(j) *Design history file.* Each manufacturer shall establish and maintain a DHF for each type of device. The DHF shall contain or reference the records necessary to demonstrate that the design was developed in accordance with the approved design plan and the requirements of this part.

### Subpart D—Document Controls

#### § 820.40 Document controls.

Each manufacturer shall establish and maintain procedures to control all documents that are required by this part. The procedures shall provide for the following:

(a) *Document approval and distribution.* Each manufacturer shall designate an individual(s) to review for adequacy and approve prior to issuance all documents established to meet the

requirements of this part. The approval, including the date and signature of the individual(s) approving the document, shall be documented. Documents established to meet the requirements of this part shall be available at all locations for which they are designated, used, or otherwise necessary, and all obsolete documents shall be promptly removed from all points of use or otherwise prevented from unintended use.

(b) *Document changes.* Changes to documents shall be reviewed and approved by an individual(s) in the same function or organization that performed the original review and approval, unless specifically designated otherwise. Approved changes shall be communicated to the appropriate personnel in a timely manner. Each manufacturer shall maintain records of changes to documents. Change records shall include a description of the change, identification of the affected documents, the signature of the approving individual(s), the approval date, and when the change becomes effective.

### Subpart E—Purchasing Controls

#### § 820.50 Purchasing controls.

Each manufacturer shall establish and maintain procedures to ensure that all purchased or otherwise received product and services conform to specified requirements.

(a) *Evaluation of suppliers, contractors, and consultants.* Each manufacturer shall establish and maintain the requirements, including quality requirements, that must be met by suppliers, contractors, and consultants. Each manufacturer shall:

(1) Evaluate and select potential suppliers, contractors, and consultants on the basis of their ability to meet specified requirements, including quality requirements. The evaluation shall be documented.

(2) Define the type and extent of control to be exercised over the product, services, suppliers, contractors, and consultants, based on the evaluation results.

(3) Establish and maintain records of acceptable suppliers, contractors, and consultants.

(b) *Purchasing data.* Each manufacturer shall establish and maintain data that clearly describe or reference the specified requirements, including quality requirements, for purchased or otherwise received product and services. Purchasing documents shall include, where possible, an agreement that the suppliers, contractors, and consultants agree to notify the manufacturer of changes in the product or service so that manufacturers may determine whether the changes may affect the quality of a finished device. Purchasing data shall be approved in accordance with § 820.40.

### Subpart F—Identification and Traceability

#### § 820.60 Identification.

Each manufacturer shall establish and maintain procedures for identifying product during all stages of receipt, production, distribution, and installation to prevent mixups.

#### § 820.65 Traceability.

Each manufacturer of a device that is intended for surgical implant into the body or to support or sustain life and whose failure to perform when properly used in accordance with instructions for use provided in the labeling can be reasonably expected to result in a significant injury to the user shall establish and maintain procedures for identifying with a control number each unit, lot, or batch of finished devices and where appropriate components. The procedures shall facilitate corrective action. Such identification shall be documented in the DHR.

### Subpart G—Production and Process Controls

#### § 820.70 Production and process controls.

(a) *General.* Each manufacturer shall develop, conduct, control, and monitor production processes to ensure that a device conforms to its specifications. Where deviations from device specifications could occur as a result of the manufacturing process, the manufacturer shall establish and maintain process control procedures that de-

scribe any process controls necessary to ensure conformance to specifications. Where process controls are needed they shall include:

(1) Documented instructions, standard operating procedures (SOP's), and methods that define and control the manner of production;

(2) Monitoring and control of process parameters and component and device characteristics during production;

(3) Compliance with specified reference standards or codes;

(4) The approval of processes and process equipment; and

(5) Criteria for workmanship which shall be expressed in documented standards or by means of identified and approved representative samples.

(b) *Production and process changes.* Each manufacturer shall establish and maintain procedures for changes to a specification, method, process, or procedure. Such changes shall be verified or where appropriate validated according to § 820.75, before implementation and these activities shall be documented. Changes shall be approved in accordance with § 820.40.

(c) *Environmental control.* Where environmental conditions could reasonably be expected to have an adverse effect on product quality, the manufacturer shall establish and maintain procedures to adequately control these environmental conditions. Environmental control system(s) shall be periodically inspected to verify that the system, including necessary equipment, is adequate and functioning properly. These activities shall be documented and reviewed.

(d) *Personnel.* Each manufacturer shall establish and maintain requirements for the health, cleanliness, personal practices, and clothing of personnel if contact between such personnel and product or environment could reasonably be expected to have an adverse effect on product quality. The manufacturer shall ensure that maintenance and other personnel who are required to work temporarily under special environmental conditions are appropriately trained or supervised by a trained individual.

(e) *Contamination control.* Each manufacturer shall establish and maintain procedures to prevent contamination of

## § 820.72

equipment or product by substances that could reasonably be expected to have an adverse effect on product quality.

(f) *Buildings*. Buildings shall be of suitable design and contain sufficient space to perform necessary operations, prevent mixups, and assure orderly handling.

(g) *Equipment*. Each manufacturer shall ensure that all equipment used in the manufacturing process meets specified requirements and is appropriately designed, constructed, placed, and installed to facilitate maintenance, adjustment, cleaning, and use.

(1) *Maintenance schedule*. Each manufacturer shall establish and maintain schedules for the adjustment, cleaning, and other maintenance of equipment to ensure that manufacturing specifications are met. Maintenance activities, including the date and individual(s) performing the maintenance activities, shall be documented.

(2) *Inspection*. Each manufacturer shall conduct periodic inspections in accordance with established procedures to ensure adherence to applicable equipment maintenance schedules. The inspections, including the date and individual(s) conducting the inspections, shall be documented.

(3) *Adjustment*. Each manufacturer shall ensure that any inherent limitations or allowable tolerances are visibly posted on or near equipment requiring periodic adjustments or are readily available to personnel performing these adjustments.

(h) *Manufacturing material*. Where a manufacturing material could reasonably be expected to have an adverse effect on product quality, the manufacturer shall establish and maintain procedures for the use and removal of such manufacturing material to ensure that it is removed or limited to an amount that does not adversely affect the device's quality. The removal or reduction of such manufacturing material shall be documented.

(i) *Automated processes*. When computers or automated data processing systems are used as part of production or the quality system, the manufacturer shall validate computer software for its intended use according to an established protocol. All software

## 21 CFR Ch. I (4-1-20 Edition)

changes shall be validated before approval and issuance. These validation activities and results shall be documented.

### § 820.72 Inspection, measuring, and test equipment.

(a) *Control of inspection, measuring, and test equipment*. Each manufacturer shall ensure that all inspection, measuring, and test equipment, including mechanical, automated, or electronic inspection and test equipment, is suitable for its intended purposes and is capable of producing valid results. Each manufacturer shall establish and maintain procedures to ensure that equipment is routinely calibrated, inspected, checked, and maintained. The procedures shall include provisions for handling, preservation, and storage of equipment, so that its accuracy and fitness for use are maintained. These activities shall be documented.

(b) *Calibration*. Calibration procedures shall include specific directions and limits for accuracy and precision. When accuracy and precision limits are not met, there shall be provisions for remedial action to reestablish the limits and to evaluate whether there was any adverse effect on the device's quality. These activities shall be documented.

(1) *Calibration standards*. Calibration standards used for inspection, measuring, and test equipment shall be traceable to national or international standards. If national or international standards are not practical or available, the manufacturer shall use an independent reproducible standard. If no applicable standard exists, the manufacturer shall establish and maintain an in-house standard.

(2) *Calibration records*. The equipment identification, calibration dates, the individual performing each calibration, and the next calibration date shall be documented. These records shall be displayed on or near each piece of equipment or shall be readily available to the personnel using such equipment and to the individuals responsible for calibrating the equipment.

### § 820.75 Process validation.

(a) Where the results of a process cannot be fully verified by subsequent



inspection and test, the process shall be validated with a high degree of assurance and approved according to established procedures. The validation activities and results, including the date and signature of the individual(s) approving the validation and where appropriate the major equipment validated, shall be documented.

(b) Each manufacturer shall establish and maintain procedures for monitoring and control of process parameters for validated processes to ensure that the specified requirements continue to be met.

(1) Each manufacturer shall ensure that validated processes are performed by qualified individual(s).

(2) For validated processes, the monitoring and control methods and data, the date performed, and, where appropriate, the individual(s) performing the process or the major equipment used shall be documented.

(c) When changes or process deviations occur, the manufacturer shall review and evaluate the process and perform revalidation where appropriate. These activities shall be documented.

### Subpart H—Acceptance Activities

#### § 820.80 Receiving, in-process, and finished device acceptance.

(a) *General.* Each manufacturer shall establish and maintain procedures for acceptance activities. Acceptance activities include inspections, tests, or other verification activities.

(b) *Receiving acceptance activities.* Each manufacturer shall establish and maintain procedures for acceptance of incoming product. Incoming product shall be inspected, tested, or otherwise verified as conforming to specified requirements. Acceptance or rejection shall be documented.

(c) *In-process acceptance activities.* Each manufacturer shall establish and maintain acceptance procedures, where appropriate, to ensure that specified requirements for in-process product are met. Such procedures shall ensure that in-process product is controlled until the required inspection and tests or other verification activities have been completed, or necessary approvals are received, and are documented.

(d) *Final acceptance activities.* Each manufacturer shall establish and maintain procedures for finished device acceptance to ensure that each production run, lot, or batch of finished devices meets acceptance criteria. Finished devices shall be held in quarantine or otherwise adequately controlled until released. Finished devices shall not be released for distribution until:

(1) The activities required in the DMR are completed;

(2) the associated data and documentation is reviewed;

(3) the release is authorized by the signature of a designated individual(s); and

(4) the authorization is dated.

(e) *Acceptance records.* Each manufacturer shall document acceptance activities required by this part. These records shall include:

(1) The acceptance activities performed;

(2) the dates acceptance activities are performed;

(3) the results;

(4) the signature of the individual(s) conducting the acceptance activities; and

(5) where appropriate the equipment used. These records shall be part of the DHR.

#### § 820.86 Acceptance status.

Each manufacturer shall identify by suitable means the acceptance status of product, to indicate the conformance or nonconformance of product with acceptance criteria. The identification of acceptance status shall be maintained throughout manufacturing, packaging, labeling, installation, and servicing of the product to ensure that only product which has passed the required acceptance activities is distributed, used, or installed.

### Subpart I—Nonconforming Product

#### § 820.90 Nonconforming product.

(a) *Control of nonconforming product.* Each manufacturer shall establish and maintain procedures to control product

that does not conform to specified requirements. The procedures shall address the identification, documentation, evaluation, segregation, and disposition of nonconforming product. The evaluation of nonconformance shall include a determination of the need for an investigation and notification of the persons or organizations responsible for the nonconformance. The evaluation and any investigation shall be documented.

(b) *Nonconformity review and disposition.* (1) Each manufacturer shall establish and maintain procedures that define the responsibility for review and the authority for the disposition of nonconforming product. The procedures shall set forth the review and disposition process. Disposition of nonconforming product shall be documented. Documentation shall include the justification for use of nonconforming product and the signature of the individual(s) authorizing the use.

(2) Each manufacturer shall establish and maintain procedures for rework, to include retesting and reevaluation of the nonconforming product after rework, to ensure that the product meets its current approved specifications. Rework and reevaluation activities, including a determination of any adverse effect from the rework upon the product, shall be documented in the DHR.

### Subpart J—Corrective and Preventive Action

#### § 820.100 Corrective and preventive action.

(a) Each manufacturer shall establish and maintain procedures for implementing corrective and preventive action. The procedures shall include requirements for:

(1) Analyzing processes, work operations, concessions, quality audit reports, quality records, service records, complaints, returned product, and other sources of quality data to identify existing and potential causes of nonconforming product, or other quality problems. Appropriate statistical methodology shall be employed where necessary to detect recurring quality problems;

(2) Investigating the cause of nonconformities relating to product, processes, and the quality system;

(3) Identifying the action(s) needed to correct and prevent recurrence of nonconforming product and other quality problems;

(4) Verifying or validating the corrective and preventive action to ensure that such action is effective and does not adversely affect the finished device;

(5) Implementing and recording changes in methods and procedures needed to correct and prevent identified quality problems;

(6) Ensuring that information related to quality problems or nonconforming product is disseminated to those directly responsible for assuring the quality of such product or the prevention of such problems; and

(7) Submitting relevant information on identified quality problems, as well as corrective and preventive actions, for management review.

(b) All activities required under this section, and their results, shall be documented.

### Subpart K—Labeling and Packaging Control

#### § 820.120 Device labeling.

Each manufacturer shall establish and maintain procedures to control labeling activities.

(a) *Label integrity.* Labels shall be printed and applied so as to remain legible and affixed during the customary conditions of processing, storage, handling, distribution, and where appropriate use.

(b) *Labeling inspection.* Labeling shall not be released for storage or use until a designated individual(s) has examined the labeling for accuracy including, where applicable, the correct unique device identifier (UDI) or universal product code (UPC), expiration date, control number, storage instructions, handling instructions, and any additional processing instructions. The release, including the date and signature of the individual(s) performing the examination, shall be documented in the DHR.

(c) *Labeling storage.* Each manufacturer shall store labeling in a manner

that provides proper identification and is designed to prevent mixups.

(d) *Labeling operations.* Each manufacturer shall control labeling and packaging operations to prevent labeling mixups. The label and labeling used for each production unit, lot, or batch shall be documented in the DHR.

(e) *Control number.* Where a control number is required by § 820.65, that control number shall be on or shall accompany the device through distribution.

[61 FR 52654, Oct. 7, 1996, as amended at 78 FR 58822, Sept. 24, 2013]

#### § 820.130 Device packaging.

Each manufacturer shall ensure that device packaging and shipping containers are designed and constructed to protect the device from alteration or damage during the customary conditions of processing, storage, handling, and distribution.

### Subpart L—Handling, Storage, Distribution, and Installation

#### § 820.140 Handling.

Each manufacturer shall establish and maintain procedures to ensure that mixups, damage, deterioration, contamination, or other adverse effects to product do not occur during handling.

#### § 820.150 Storage.

(a) Each manufacturer shall establish and maintain procedures for the control of storage areas and stock rooms for product to prevent mixups, damage, deterioration, contamination, or other adverse effects pending use or distribution and to ensure that no obsolete, rejected, or deteriorated product is used or distributed. When the quality of product deteriorates over time, it shall be stored in a manner to facilitate proper stock rotation, and its condition shall be assessed as appropriate.

(b) Each manufacturer shall establish and maintain procedures that describe the methods for authorizing receipt from and dispatch to storage areas and stock rooms.

#### § 820.160 Distribution.

(a) Each manufacturer shall establish and maintain procedures for control and distribution of finished devices to

ensure that only those devices approved for release are distributed and that purchase orders are reviewed to ensure that ambiguities and errors are resolved before devices are released for distribution. Where a device's fitness for use or quality deteriorates over time, the procedures shall ensure that expired devices or devices deteriorated beyond acceptable fitness for use are not distributed.

(b) Each manufacturer shall maintain distribution records which include or refer to the location of:

- (1) The name and address of the initial consignee;
- (2) The identification and quantity of devices shipped;
- (3) The date shipped; and
- (4) Any control number(s) used.

#### § 820.170 Installation.

(a) Each manufacturer of a device requiring installation shall establish and maintain adequate installation and inspection instructions, and where appropriate test procedures. Instructions and procedures shall include directions for ensuring proper installation so that the device will perform as intended after installation. The manufacturer shall distribute the instructions and procedures with the device or otherwise make them available to the person(s) installing the device.

(b) The person installing the device shall ensure that the installation, inspection, and any required testing are performed in accordance with the manufacturer's instructions and procedures and shall document the inspection and any test results to demonstrate proper installation.

### Subpart M—Records

#### § 820.180 General requirements.

All records required by this part shall be maintained at the manufacturing establishment or other location that is reasonably accessible to responsible officials of the manufacturer and to employees of FDA designated to perform inspections. Such records, including those not stored at the inspected establishment, shall be made readily available for review and copying by FDA employee(s). Such records shall be legible and shall be stored to minimize

## § 820.181

deterioration and to prevent loss. Those records stored in automated data processing systems shall be backed up.

(a) *Confidentiality.* Records deemed confidential by the manufacturer may be marked to aid FDA in determining whether information may be disclosed under the public information regulation in part 20 of this chapter.

(b) *Record retention period.* All records required by this part shall be retained for a period of time equivalent to the design and expected life of the device, but in no case less than 2 years from the date of release for commercial distribution by the manufacturer.

(c) *Exceptions.* This section does not apply to the reports required by § 820.20(c) Management review, § 820.22 Quality audits, and supplier audit reports used to meet the requirements of § 820.50(a) Evaluation of suppliers, contractors, and consultants, but does apply to procedures established under these provisions. Upon request of a designated employee of FDA, an employee in management with executive responsibility shall certify in writing that the management reviews and quality audits required under this part, and supplier audits where applicable, have been performed and documented, the dates on which they were performed, and that any required corrective action has been undertaken.

### § 820.181 Device master record.

Each manufacturer shall maintain device master records (DMR's). Each manufacturer shall ensure that each DMR is prepared and approved in accordance with § 820.40. The DMR for each type of device shall include, or refer to the location of, the following information:

(a) Device specifications including appropriate drawings, composition, formulation, component specifications, and software specifications;

(b) Production process specifications including the appropriate equipment specifications, production methods, production procedures, and production environment specifications;

(c) Quality assurance procedures and specifications including acceptance criteria and the quality assurance equipment to be used;

## 21 CFR Ch. I (4–1–20 Edition)

(d) Packaging and labeling specifications, including methods and processes used; and

(e) Installation, maintenance, and servicing procedures and methods.

### § 820.184 Device history record.

Each manufacturer shall maintain device history records (DHR's). Each manufacturer shall establish and maintain procedures to ensure that DHR's for each batch, lot, or unit are maintained to demonstrate that the device is manufactured in accordance with the DMR and the requirements of this part. The DHR shall include, or refer to the location of, the following information:

(a) The dates of manufacture;

(b) The quantity manufactured;

(c) The quantity released for distribution;

(d) The acceptance records which demonstrate the device is manufactured in accordance with the DMR;

(e) The primary identification label and labeling used for each production unit; and

(f) Any unique device identifier (UDI) or universal product code (UPC), and any other device identification(s) and control number(s) used.

[61 FR 52654, Oct. 7, 1996, as amended at 78 FR 58822, Sept. 24, 2013]

### § 820.186 Quality system record.

Each manufacturer shall maintain a quality system record (QSR). The QSR shall include, or refer to the location of, procedures and the documentation of activities required by this part that are not specific to a particular type of device(s), including, but not limited to, the records required by § 820.20. Each manufacturer shall ensure that the QSR is prepared and approved in accordance with § 820.40.

### § 820.198 Complaint files.

(a) Each manufacturer shall maintain complaint files. Each manufacturer shall establish and maintain procedures for receiving, reviewing, and evaluating complaints by a formally designated unit. Such procedures shall ensure that:

(1) All complaints are processed in a uniform and timely manner;

(2) Oral complaints are documented upon receipt; and

(3) Complaints are evaluated to determine whether the complaint represents an event which is required to be reported to FDA under part 803 of this chapter, Medical Device Reporting.

(b) Each manufacturer shall review and evaluate all complaints to determine whether an investigation is necessary. When no investigation is made, the manufacturer shall maintain a record that includes the reason no investigation was made and the name of the individual responsible for the decision not to investigate.

(c) Any complaint involving the possible failure of a device, labeling, or packaging to meet any of its specifications shall be reviewed, evaluated, and investigated, unless such investigation has already been performed for a similar complaint and another investigation is not necessary.

(d) Any complaint that represents an event which must be reported to FDA under part 803 of this chapter shall be promptly reviewed, evaluated, and investigated by a designated individual(s) and shall be maintained in a separate portion of the complaint files or otherwise clearly identified. In addition to the information required by § 820.198(e), records of investigation under this paragraph shall include a determination of:

(1) Whether the device failed to meet specifications;

(2) Whether the device was being used for treatment or diagnosis; and

(3) The relationship, if any, of the device to the reported incident or adverse event.

(e) When an investigation is made under this section, a record of the investigation shall be maintained by the formally designated unit identified in paragraph (a) of this section. The record of investigation shall include:

(1) The name of the device;

(2) The date the complaint was received;

(3) Any unique device identifier (UDI) or universal product code (UPC), and any other device identification(s) and control number(s) used;

(4) The name, address, and phone number of the complainant;

(5) The nature and details of the complaint;

(6) The dates and results of the investigation;

(7) Any corrective action taken; and

(8) Any reply to the complainant.

(f) When the manufacturer's formally designated complaint unit is located at a site separate from the manufacturing establishment, the investigated complaint(s) and the record(s) of investigation shall be reasonably accessible to the manufacturing establishment.

(g) If a manufacturer's formally designated complaint unit is located outside of the United States, records required by this section shall be reasonably accessible in the United States at either:

(1) A location in the United States where the manufacturer's records are regularly kept; or

(2) The location of the initial distributor.

[61 FR 52654, Oct. 7, 1996, as amended at 69 FR 11313, Mar. 10, 2004; 71 FR 16228, Mar. 31, 2006; 78 FR 58822, Sept. 24, 2013]

### Subpart N—Servicing

#### § 820.200 Servicing.

(a) Where servicing is a specified requirement, each manufacturer shall establish and maintain instructions and procedures for performing and verifying that the servicing meets the specified requirements.

(b) Each manufacturer shall analyze service reports with appropriate statistical methodology in accordance with § 820.100.

(c) Each manufacturer who receives a service report that represents an event which must be reported to FDA under part 803 of this chapter shall automatically consider the report a complaint and shall process it in accordance with the requirements of § 820.198.

(d) Service reports shall be documented and shall include:

(1) The name of the device serviced;

(2) Any unique device identifier (UDI) or universal product code (UPC), and any other device identification(s) and control number(s) used;

(3) The date of service;

(4) The individual(s) servicing the device;

(5) The service performed; and

(6) The test and inspection data.

[61 FR 52654, Oct. 7, 1996, as amended at 69 FR 11313, Mar. 10, 2004; 78 FR 58822, Sept. 24, 2013]

**Subpart O—Statistical Techniques**

**§ 820.250 Statistical techniques.**

(a) Where appropriate, each manufacturer shall establish and maintain procedures for identifying valid statistical techniques required for establishing, controlling, and verifying the acceptability of process capability and product characteristics.

(b) Sampling plans, when used, shall be written and based on a valid statistical rationale. Each manufacturer shall establish and maintain procedures to ensure that sampling methods are adequate for their intended use and to ensure that when changes occur the sampling plans are reviewed. These activities shall be documented.

**PART 821—MEDICAL DEVICE TRACKING REQUIREMENTS**

**Subpart A—General Provisions**

Sec.

821.1 Scope.

821.2 Exemptions and variances.

821.3 Definitions.

821.4 Imported devices.

**Subpart B—Tracking Requirements**

821.20 Devices subject to tracking.

821.25 Device tracking system and content requirements: manufacturer requirements.

**Subpart C—Additional Requirements and Responsibilities**

821.30 Tracking obligations of persons other than device manufacturers: distributor requirements.

**Subpart D—Records and Inspections**

821.50 Availability.

821.55 Confidentiality.

821.60 Retention of records.

AUTHORITY: 21 U.S.C. 331, 351, 352, 360, 360e, 360h, 360i, 371, 374.

SOURCE: 58 FR 43447, Aug. 16, 1993, unless otherwise noted.

**Subpart A—General Provisions**

**§ 821.1 Scope.**

(a) The regulations in this part implement section 519(e) of the Federal Food, Drug, and Cosmetic Act (the act), which provides that the Food and Drug Administration may require a manufacturer to adopt a method of tracking a class II or class III device, if the device meets one of the following three criteria and FDA issues an order to the manufacturer: the failure of the device would be reasonably likely to have serious adverse health consequences; or the device is intended to be implanted in the human body for more than 1 year; or the device is a life-sustaining or life-supporting device used outside a device user facility. A device that meets one of these criteria and is the subject of an FDA order must comply with this part and is referred to, in this part, as a “tracked device.”

(b) These regulations are intended to ensure that tracked devices can be traced from the device manufacturing facility to the person for whom the device is indicated, that is, the patient. Effective tracking of devices from the manufacturing facility, through the distributor network (including distributors, retailers, rental firms and other commercial enterprises, device user facilities, and licensed practitioners) and, ultimately, to the patient is necessary for the effectiveness of remedies prescribed by the act, such as patient notification (section 518(a) of the act) or device recall (section 518(e) of the act). Although these regulations do not preclude a manufacturer from involving outside organizations in that manufacturer’s device tracking effort, the legal responsibility for complying with this part rests with manufacturers who are subject to tracking orders, and that responsibility cannot be altered, modified, or in any way abrogated by contracts or other agreements.

(c) The primary burden for ensuring that the tracking system works rests upon the manufacturer. A manufacturer or any other person, including a distributor, final distributor, or multiple distributor, who distributes a device subject to tracking, who fails to

comply with any applicable requirement of section 519(e) of the act or of this part, or any person who causes such failure, misbrands the device within the meaning of section 502(t)(2) of the act and commits a prohibited act within the meaning of sections 301(e) and 301(q)(1)(B) of the act.

(d) Any person subject to this part who permanently discontinues doing business is required to notify FDA at the time the person notifies any government agency, court, or supplier, and provide FDA with a complete set of its tracking records and information. However, if a person ceases distribution of a tracked device but continues to do other business, that person continues to be responsible for compliance with this part unless another person, affirmatively and in writing, assumes responsibility for continuing the tracking of devices previously distributed under this part. Further, if a person subject to this part goes out of business completely, but other persons acquire the right to manufacture or distribute tracked devices, those other persons are deemed to be responsible for continuing the tracking responsibility of the previous person under this part.

[58 FR 43447, Aug. 16, 1993, as amended at 67 FR 5951, Feb. 8, 2002; 73 FR 34860, June 19, 2008]

#### § 821.2 Exemptions and variances.

(a) A manufacturer, importer, or distributor may seek an exemption or variance from one or more requirements of this part.

(b) A request for an exemption or variance shall be submitted in the form of a petition under § 10.30 of this chapter and shall comply with the requirements set out therein, except that a response shall be issued in 90 days. The Director or Deputy Directors, CDRH, or the Director, Office of Compliance, CDRH, shall issue responses to requests under this section. The petition shall also contain the following:

(1) The name of the device and device class and representative labeling showing the intended use(s) of the device;

(2) The reasons that compliance with the tracking requirements of this part is unnecessary;

(3) A complete description of alternative steps that are available, or that the petitioner has already taken, to ensure that an effective tracking system is in place; and

(4) Other information justifying the exemption or variance.

(c) An exemption or variance is not effective until the Director, Office of Compliance, CDRH, approves the request under § 10.30(e)(2)(i) of this chapter.

[58 FR 43447, Aug. 16, 1993, as amended at 59 FR 31138, June 17, 1994; 67 FR 5951, Feb. 8, 2002; 72 FR 17399, Apr. 9, 2007]

#### § 821.3 Definitions.

The following definitions and terms apply to this part:

(a) *Act* means the Federal Food, Drug, and Cosmetic Act, 21 U.S.C. 321 *et seq.*, as amended.

(b) *Importer* means the initial distributor of an imported device who is subject to a tracking order. "Importer" does not include anyone who only furthers the marketing, e.g., brokers, jobbers, or warehousemen.

(c) *Manufacturer* means any person, including any importer, repacker and/or relabeler, who manufactures, prepares, propagates, compounds, assembles, or processes a device or engages in any of the activities described in § 807.3(d) of this chapter.

(d) *Device failure* means the failure of a device to perform or function as intended, including any deviations from the device's performance specifications or intended use.

(e) *Serious adverse health consequences* means any significant adverse experience related to a device, including device-related events which are life-threatening or which involve permanent or long-term injuries or illnesses.

(f) *Device intended to be implanted in the human body for more than 1 year* means a device that is intended to be placed into a surgically or naturally formed cavity of the human body for more than 1 year to continuously assist, restore, or replace the function of an organ system or structure of the human body throughout the useful life of the device. The term does not include a device that is intended and used only for temporary purposes or

## § 821.4

## 21 CFR Ch. I (4–1–20 Edition)

that is intended for explantation in 1 year or less.

(g) *Life-supporting or life-sustaining device used outside a device user facility* means a device which is essential, or yields information that is essential, to the restoration or continuation of a bodily function important to the continuation of human life that is intended for use outside a hospital, nursing home, ambulatory surgical facility, or diagnostic or outpatient treatment facility. Physicians' offices are not device user facilities and, therefore, devices used therein are subject to tracking if they otherwise satisfy the statutory and regulatory criteria.

(h) *Distributor* means any person who furthers the distribution of a device from the original place of manufacture to the person who makes delivery or sale to the ultimate user, i.e., the final or multiple distributor, but who does not repackage or otherwise change the container, wrapper, or labeling of the device or device package.

(i) *Final distributor* means any person who distributes a tracked device intended for use by a single patient over the useful life of the device to the patient. This term includes, but is not limited to, licensed practitioners, retail pharmacies, hospitals, and other types of device user facilities.

(j) *Distributes* means any distribution of a tracked device, including the charitable distribution of a tracked device. This term does not include the distribution of a device under an effective investigational device exemption in accordance with section 520(g) of the act and part 812 of this chapter or the distribution of a device for teaching, law enforcement, research, or analysis as specified in § 801.125 of this chapter.

(k) *Multiple distributor* means any device user facility, rental company, or any other entity that distributes a life-sustaining or life-supporting device intended for use by more than one patient over the useful life of the device.

(l) *Licensed practitioner* means a physician, dentist, or other health care practitioner licensed by the law of the State in which he or she practices to use or order the use of the tracked device.

(m) Any term defined in section 201 of the act shall have the same definition in this part.

(n) *Human cell, tissue, or cellular or tissue-based product (HCT/P) regulated as a device* means an HCT/P as defined in § 1271.3(d) of this chapter that does not meet the criteria in § 1271.10(a) and that is also regulated as a device.

(o) *Unique device identifier (UDI)* means an identifier that adequately identifies a device through its distribution and use by meeting the requirements of § 830.20 of this chapter. A unique device identifier is composed of:

(1) A *device identifier*—a mandatory, fixed portion of a UDI that identifies the specific version or model of a device and the labeler of that device; and

(2) A *production identifier*—a conditional, variable portion of a UDI that identifies one or more of the following when included on the label of the device:

(i) The lot or batch within which a device was manufactured;

(ii) The serial number of a specific device;

(iii) The expiration date of a specific device;

(iv) The date a specific device was manufactured.

(v) For an HCT/P regulated as a device, the distinct identification code required by § 1271.290(c) of this chapter.

[58 FR 43447, Aug. 16, 1993, as amended at 67 FR 5951, Feb. 8, 2002; 78 FR 58822, Sept. 24, 2013]

### § 821.4 Imported devices.

For purposes of this part, the importer of a tracked device shall be considered the manufacturer and shall be required to comply with all requirements of this part applicable to manufacturers. Importers must keep all information required under this part in the United States.

## Subpart B—Tracking Requirements

### § 821.20 Devices subject to tracking.

(a) A manufacturer of any class II or class III device that fits within one of the three criteria within § 821.1(a) must track that device in accordance with this part, if FDA issues a tracking order to that manufacturer.



(b) When responding to premarket notification submissions and premarket approval applications, FDA will notify the sponsor by issuing an order that states that FDA believes the device meets the criteria of section 519(e)(1) of the act and, by virtue of the order, the sponsor must track the device.

[67 FR 5951, Feb. 8, 2002]

**§ 821.25 Device tracking system and content requirements: manufacturer requirements.**

(a) A manufacturer of a tracked device shall adopt a method of tracking for each such type of device that it distributes that enables a manufacturer to provide FDA with the following information in writing for each tracked device distributed:

(1) Except as required by order under section 518(e) of the act, within 3 working days of a request from FDA, prior to the distribution of a tracked device to a patient, the name, address, and telephone number of the distributor, multiple distributor, or final distributor holding the device for distribution and the location of the device;

(2) Within 10 working days of a request from FDA for tracked devices that are intended for use by a single patient over the life of the device, after distribution to or implantation in a patient:

(i) The unique device identifier (UDI), lot number, batch number, model number, or serial number of the device or other identifier necessary to provide for effective tracking of the devices;

(ii) The date the device was shipped by the manufacturer;

(iii) The name, address, telephone number, and social security number (if available) of the patient receiving the device, unless not released by the patient under § 821.55(a);

(iv) The date the device was provided to the patient;

(v) The name, mailing address, and telephone number of the prescribing physician;

(vi) The name, mailing address, and telephone number of the physician regularly following the patient if different than the prescribing physician; and

(vii) If applicable, the date the device was explanted and the name, mailing address, and telephone number of the explanting physician; the date of the patient's death; or the date the device was returned to the manufacturer, permanently retired from use, or otherwise permanently disposed of.

(3) Except as required by order under section 518(e) of the act, within 10 working days of a request from FDA for tracked devices that are intended for use by more than one patient, after the distribution of the device to the multiple distributor:

(i) The unique device identifier (UDI), lot number, batch number, model number, or serial number of the device or other identifier necessary to provide for effective tracking of the devices;

(ii) The date the device was shipped by the manufacturer;

(iii) The name, address, and telephone number of the multiple distributor;

(iv) The name, address, telephone number, and social security number (if available) of the patient using the device, unless not released by the patient under § 821.55(a);

(v) The location of the device;

(vi) The date the device was provided for use by the patient;

(vii) The name, address, and telephone number of the prescribing physician; and

(viii) If and when applicable, the date the device was returned to the manufacturer, permanently retired from use, or otherwise permanently disposed of.

(b) A manufacturer of a tracked device shall keep current records in accordance with its standard operating procedure of the information identified in paragraphs (a)(1), (a)(2) and (a)(3)(i) through (a)(3)(iii) of this section on each tracked device released for distribution for as long as such device is in use or in distribution for use.

(c) A manufacturer of a tracked device shall establish a written standard operating procedure for the collection, maintenance, and auditing of the data specified in paragraphs (a) and (b) of this section. A manufacturer shall make this standard operating procedure available to FDA upon request. A

manufacturer shall incorporate the following into the standard operating procedure:

(1) Data collection and recording procedures, which shall include a procedure for recording when data which is required under this part is missing and could not be collected and the reason why such required data is missing and could not be collected;

(2) A method for recording all modifications or changes to the tracking system or to the data collected and maintained under the tracking system, reasons for any modification or change, and dates of any modification or change. Modification and changes included under this requirement include modifications to the data (including termination of tracking), the data format, the recording system, and the file maintenance procedures system; and

(3) A quality assurance program that includes an audit procedure to be run for each device product subject to tracking, at not less than 6-month intervals for the first 3 years of distribution and at least once a year thereafter. This audit procedure shall provide for statistically relevant sampling of the data collected to ensure the accuracy of data and performance testing of the functioning of the tracking system.

(d) When a manufacturer becomes aware that a distributor, final distributor, or multiple distributor has not collected, maintained, or furnished any record or information required by this part, the manufacturer shall notify the FDA district office responsible for the area in which the distributor, final distributor, or multiple distributor is located of the failure of such persons to comply with the requirements of this part. Manufacturers shall have taken reasonable steps to obtain compliance by the distributor, multiple distributor, or final distributor in question before notifying FDA.

(e) A manufacturer may petition for an exemption or variance from one or more requirements of this part according to the procedures in § 821.2 of this chapter.

[58 FR 43447, Aug. 16, 1993, as amended at 67 FR 5951, Feb. 8, 2002; 78 FR 58822, Sept. 24, 2013]

### Subpart C—Additional Requirements and Responsibilities

#### § 821.30 Tracking obligations of persons other than device manufacturers: distributor requirements.

(a) A distributor, final distributor, or multiple distributor of any tracked device shall, upon purchasing or otherwise acquiring any interest in such a device, promptly provide the manufacturer tracking the device with the following information:

(1) The name and address of the distributor, final distributor or multiple distributor;

(2) The unique device identifier (UDI), lot number, batch number, model number, or serial number of the device or other identifier used by the manufacturer to track the device;

(3) The date the device was received;

(4) The person from whom the device was received;

(5) If and when applicable, the date the device was explanted, the date of the patient's death, or the date the device was returned to the distributor, permanently retired from use, or otherwise permanently disposed of.

(b) A final distributor, upon sale or other distribution of a tracked device for use in or by the patient, shall promptly provide the manufacturer tracking the device with the following information:

(1) The name and address of the final distributor,

(2) The unique device identifier (UDI), lot number, batch number, model number, or serial number of the device or other identifier used by the manufacturer to track the device;

(3) The name, address, telephone number, and social security number (if available) of the patient receiving the device, unless not released by the patient under § 821.55(a);

(4) The date the device was provided to the patient or for use in the patient;

(5) The name, mailing address, and telephone number of the prescribing physician;

(6) The name, mailing address, and telephone number of the physician regularly following the patient if different than the prescribing physician; and

(7) When applicable, the date the device was explanted and the name, mailing address, and telephone number of the explanting physician, the date of the patient's death, or the date the device was returned to the manufacturer, permanently retired from use, or otherwise permanently disposed of.

(c)(1) A multiple distributor shall keep written records of the following each time such device is distributed for use by a patient:

(i) The unique device identifier (UDI), lot number, batch number, model number, or serial number of the device or other identifier used by the manufacturer to track the device;

(ii) The name, address, telephone number, and social security number (if available) of the patient using the device;

(iii) The location of the device, unless not released by the patient under § 821.55(a);

(iv) The date the device was provided for use by the patient;

(v) The name, address, and telephone number of the prescribing physician;

(vi) The name, address, and telephone number of the physician regularly following the patient if different than the prescribing physician; and

(vii) When applicable, the date the device was permanently retired from use or otherwise permanently disposed of.

(2) Except as required by order under section 518(e) of the act, any person who is a multiple distributor subject to the recordkeeping requirement of paragraph (c)(1) of this section shall, within 5 working days of a request from the manufacturer or within 10 working days of a request from FDA for the information identified in paragraph (c)(1) of this section, provide such information to the manufacturer or FDA.

(d) A distributor, final distributor, or multiple distributor shall make any records required to be kept under this part available to the manufacturer of the tracked device for audit upon written request by an authorized representative of the manufacturer.

(e) A distributor, final distributor, or multiple distributor may petition for an exemption or variance from one or

more requirements of this part according to the procedures in § 821.2.

[58 FR 43447, Aug. 16, 1993, as amended at 67 FR 5951, Feb. 8, 2002; 78 FR 58822, Sept. 24, 2013]

### Subpart D—Records and Inspections

#### § 821.50 Availability.

(a) Manufacturers, distributors, multiple distributors, and final distributors shall, upon the presentation by an FDA representative of official credentials and the issuance of Form FDA 482 at the initiation of an inspection of an establishment or person under section 704 of the act, make each record and all information required to be collected and maintained under this part and all records and information related to the events and persons identified in such records available to FDA personnel.

(b) Records and information referenced in paragraph (a) of this section shall be available to FDA personnel for purposes of reviewing, copying, or any other use related to the enforcement of the act and this part. Records required to be kept by this part shall be kept in a centralized point for each manufacturer or distributor within the United States.

[58 FR 43447, Aug. 16, 1993, as amended at 65 FR 43690, July 14, 2000]

#### § 821.55 Confidentiality.

(a) Any patient receiving a device subject to tracking requirements under this part may refuse to release, or refuse permission to release, the patient's name, address, telephone number, and social security number, or other identifying information for the purpose of tracking.

(b) Records and other information submitted to FDA under this part shall be protected from public disclosure to the extent permitted under part 20 of this chapter, and in accordance with § 20.63 of this chapter, information contained in such records that would identify patient or research subjects shall not be available for public disclosure except as provided in those parts.

(c) Patient names or other identifiers may be disclosed to a manufacturer or other person subject to this part or to

## § 821.60

a physician when the health or safety of the patient requires that such persons have access to the information. Such notification will be pursuant to agreement that the record or information will not be further disclosed except as the health aspects of the patient requires. Such notification does not constitute public disclosure and will not trigger the availability of the same information to the public generally.

[58 FR 43447, Aug. 16, 1993, as amended at 67 FR 5951, Feb. 8, 2002]

### § 821.60 Retention of records.

Persons required to maintain records under this part shall maintain such records for the useful life of each tracked device they manufacture or distribute. The useful life of a device is the time a device is in use or in distribution for use. For example, a record may be retired if the person maintaining the record becomes aware of the fact that the device is no longer in use, has been explanted, returned to the manufacturer, or the patient has died.

## PART 822—POSTMARKET SURVEILLANCE

### Subpart A—General Provisions

Sec.

- 822.1 What does this part cover?
- 822.2 What is the purpose of this part?
- 822.3 How do you define the terms used in this part?
- 822.4 Does this part apply to me?

### Subpart B—Notification

- 822.5 How will I know if I must conduct postmarket surveillance?
- 822.6 When will you notify me that I am required to conduct postmarket surveillance?
- 822.7 What should I do if I do not agree that postmarket surveillance is appropriate?

### Subpart C—Postmarket Surveillance Plan

- 822.8 When, where, and how must I submit my postmarket surveillance plan?
- 822.9 What must I include in my submission?
- 822.10 What must I include in my surveillance plan?
- 822.11 What should I consider when designing my plan to conduct postmarket surveillance?

## 21 CFR Ch. I (4–1–20 Edition)

- 822.12 Do you have any information that will help me prepare my submission or design my postmarket surveillance plan?
- 822.13 [Reserved]
- 822.14 May I reference information previously submitted instead of submitting it again?
- 822.15 How long must I conduct postmarket surveillance of my device?

### Subpart D—FDA Review and Action

- 822.16 What will you consider in the review of my submission?
- 822.17 How long will your review of my submission take?
- 822.18 How will I be notified of your decision?
- 822.19 What kinds of decisions may you make?
- 822.20 What are the consequences if I fail to submit a postmarket surveillance plan, my plan is disapproved and I fail to submit a new plan, or I fail to conduct surveillance in accordance with my approved plan?
- 822.21 What must I do if I want to make changes to my postmarket surveillance plan after you have approved it?
- 822.22 What recourse do I have if I do not agree with your decision?
- 822.23 Is the information in my submission considered confidential?

### Subpart E—Responsibilities of Manufacturers

- 822.24 What are my responsibilities once I am notified that I am required to conduct postmarket surveillance?
- 822.25 What are my responsibilities after my postmarket surveillance plan has been approved?
- 822.26 If my company changes ownership, what must I do?
- 822.27 If I go out of business, what must I do?
- 822.28 If I stop marketing the device subject to postmarket surveillance, what must I do?

### Subpart F—Waivers and Exemptions

- 822.29 May I request a waiver of a specific requirement of this part?
- 822.30 May I request exemption from the requirement to conduct postmarket surveillance?

### Subpart G—Records and Reports

- 822.31 What records am I required to keep?
- 822.32 What records are the investigators in my surveillance plan required to keep?
- 822.33 How long must we keep the records?
- 822.34 What must I do with the records if the sponsor of the plan or an investigator in the plan changes?

822.35 Can you inspect my manufacturing site or other sites involved in my postmarket surveillance plan?

822.36 Can you inspect and copy the records related to my postmarket surveillance plan?

822.37 Under what circumstances would you inspect records identifying subjects?

822.38 What reports must I submit to you?

AUTHORITY: 21 U.S.C. 331, 352, 360i, 360l, 371, 374.

SOURCE: 67 FR 38887, June 6, 2002, unless otherwise noted.

### Subpart A—General Provisions

#### § 822.1 What does this part cover?

This part implements section 522 of the Federal Food, Drug, and Cosmetic Act (the act) by providing procedures and requirements for postmarket surveillance of class II and class III devices that meet any of the following criteria:

(a) Failure of the device would be reasonably likely to have serious adverse health consequences;

(b) The device is intended to be implanted in the human body for more than 1 year; or

(c) The device is intended to be used outside a user facility to support or sustain life. If you fail to comply with requirements that we order under section 522 of the act and this part, your device is considered misbranded under section 502(t)(3) of the act and you are in violation of section 301(q)(1)(C) of the act.

#### § 822.2 What is the purpose of this part?

The purpose of this part is to implement our postmarket surveillance authority to maximize the likelihood that postmarket surveillance plans will result in the collection of useful data. These data can reveal unforeseen adverse events, the actual rate of anticipated adverse events, or other information necessary to protect the public health.

#### § 822.3 How do you define the terms used in this part?

Some of the terms we use in this part are specific to postmarket surveillance and reflect the language used in the statute (law). Other terms are more general and reflect our interpretation

of the law. This section of the part defines the following terms:

(a) *Act* means the Federal Food, Drug, and Cosmetic Act, 21 U.S.C. 301 *et seq.*, as amended.

(b) *Designated person* means the individual who conducts or supervises the conduct of your postmarket surveillance. If your postmarket surveillance plan includes a team of investigators, as defined below, the designated person is the responsible leader of that team.

(c) *Device failure* means a device does not perform or function as intended, and includes any deviation from the device's performance specifications or intended use.

(d) *General plan guidance* means agency guidance that provides information about the requirement to conduct postmarket surveillance, the submission of a plan to us for approval, the content of the submission, and the conduct and reporting requirements of the surveillance.

(e) *Human cell, tissue, or cellular or tissue-based product (HCT/P) regulated as a device* means an HCT/P as defined in § 1271.3(d) of this chapter that does not meet the criteria in § 1271.10(a) and that is also regulated as a device.

(f) *Investigator* means an individual who collects data or information in support of a postmarket surveillance plan.

(g) *Life-supporting or life-sustaining device used outside a device user facility* means that a device is essential to, or yields information essential to, the restoration or continuation of a bodily function important to the continuation of human life and is used outside a hospital, nursing home, ambulatory surgical facility, or diagnostic or outpatient treatment facility. A physician's office is not a device user facility.

(h) *Manufacturer* means any person, including any importer, repacker, and/or relabeler, who manufactures, prepares, propagates, compounds, assembles, processes a device, or engages in any of the activities described in § 807.3(d) of this chapter.

(i) *Postmarket surveillance* means the active, systematic, scientifically valid collection, analysis, and interpretation of data or other information about a marketed device.

## § 822.4

(j) *Prospective surveillance* means that the subjects are identified at the beginning of the surveillance and data or other information will be collected from that time forward (as opposed to retrospective surveillance).

(k) *Serious adverse health consequences* means any significant adverse experience related to a device, including device-related events that are life-threatening or that involve permanent or long-term injuries or illnesses.

(l) *Specific guidance* means guidance that provides information regarding postmarket surveillance for specific types or categories of devices or specific postmarket surveillance issues. This type of guidance may be used to supplement general guidance and may address such topics as the type of surveillance approach that is appropriate for the device and the postmarket surveillance question, sample size, or specific reporting requirements.

(m) *Surveillance question* means the issue or issues to be addressed by the postmarket surveillance.

(n) *Unforeseen adverse event* means any serious adverse health consequence that either is not addressed in the labeling of the device or occurs at a rate higher than anticipated.

(o) *Unique device identifier (UDI)* means an identifier that adequately identifies a device through its distribution and use by meeting the requirements of § 830.20 of this chapter. A UDI is composed of:

(1) A *device identifier*—a mandatory, fixed portion of a UDI that identifies the specific version or model of a device and the labeler of that device; and

(2) A *production identifier*—a conditional, variable portion of a UDI that identifies one or more of the following when included on the label of the device:

(i) The lot or batch within which a device was manufactured;

(ii) The serial number of a specific device;

(iii) The expiration date of a specific device;

(iv) The date a specific device was manufactured.

## 21 CFR Ch. I (4–1–20 Edition)

(v) For an HCT/P regulated as a device, the distinct identification code required by § 1271.290(c) of this chapter.

[67 FR 38887, June 6, 2002, as amended at 78 FR 58823, Sept. 24, 2013]

### § 822.4 Does this part apply to me?

If we have ordered you to conduct postmarket surveillance of a medical device under section 522 of the act, this part applies to you. We have the authority to order postmarket surveillance of any class II or class III medical device, including a device reviewed under the licensing provisions of section 351 of the Public Health Service Act, that meets any of the following criteria:

(a) Failure of the device would be reasonably likely to have serious adverse health consequences;

(b) The device is intended to be implanted in the human body for more than 1 year; or

(c) The device is intended to be used to support or sustain life and to be used outside a user facility.

### Subpart B—Notification

#### § 822.5 How will I know if I must conduct postmarket surveillance?

We will send you a letter (the postmarket surveillance order) notifying you of the requirement to conduct postmarket surveillance. Before we send the order, or as part of the order, we may require that you submit information about your device that will allow us better to define the scope of a surveillance order. We will specify the device(s) subject to the surveillance order and the reason that we are requiring postmarket surveillance of the device under section 522 of the act. We will also provide you with any general or specific guidance that is available to help you develop your plan for conducting postmarket surveillance.

#### § 822.6 When will you notify me that I am required to conduct postmarket surveillance?

We will notify you as soon as we have determined that postmarket surveillance of your device is necessary, based on the identification of a surveillance question. This may occur during the review of a marketing application for

your device, as your device goes to market, or after your device has been marketed for a period of time.

**§ 822.7 What should I do if I do not agree that postmarket surveillance is appropriate?**

(a) If you do not agree with our decision to order postmarket surveillance for a particular device, you may request review of our decision by:

(1) Requesting a meeting with the Director, Office of Surveillance and Biometrics, who generally issues the order for postmarket surveillance;

(2) Seeking internal review of the order under § 10.75 of this chapter;

(3) Requesting an informal hearing under part 16 of this chapter; or

(4) Requesting review by the Medical Devices Dispute Resolution Panel of the Medical Devices Advisory Committee.

(b) You may obtain guidance documents that discuss these mechanisms from the Center for Devices and Radiological Health's (CDRH's) Web site (<http://www.fda.gov/AboutFDA/CentersOffices/OfficeofMedicalProductsandTobacco/CDRH/CDRHombudsman/default.htm>).

[67 FR 38887, June 6, 2002, as amended at 72 FR 17399, Apr. 9, 2007; 78 FR 18233, Mar. 26, 2013]

**Subpart C—Postmarket Surveillance Plan**

**§ 822.8 When, where, and how must I submit my postmarket surveillance plan?**

You must submit your plan to conduct postmarket surveillance within 30 days of the date you receive the postmarket surveillance order. For devices regulated by the Center for Biologics Evaluation and Research, send three copies of your submission to the Food and Drug Administration, Center for Biologics Evaluation and Research, Document Control Center, 10903 New Hampshire Ave., Bldg. 71, Rm. G112, Silver Spring, MD 20993-0002. For devices regulated by the Center for Drug Evaluation and Research, send three copies of your submission to the Central Document Room, Center for Drug Evaluation and Research, Food and Drug Administration, 5901-B,

Ammendale Rd., Beltsville, MD 20705-1266. For devices regulated by the Center for Devices and Radiological Health, send three copies of your submission to the Document Mail Center, 10903 New Hampshire Ave., Bldg. 66, rm. G609, Silver Spring, MD 20993-0002. When we receive your original submission, we will send you an acknowledgment letter identifying the unique document number assigned to your submission. You must use this number in any correspondence related to this submission.

[75 FR 20915, Apr. 22, 2010, as amended at 80 FR 18094, Apr. 3, 2015]

**§ 822.9 What must I include in my submission?**

Your submission must include the following:

(a) Organizational/administrative information:

(1) Your name and address;

(2) Generic and trade names of your device;

(3) Name and address of the contact person for the submission;

(4) Premarket application/submission number and device identifiers for your device;

(5) Table of contents identifying the page numbers for each section of the submission;

(6) Description of the device (this may be incorporated by reference to the appropriate premarket application/submission);

(7) Product codes and a list of all relevant model numbers; and

(8) Indications for use and claims for the device;

(b) Postmarket surveillance plan;

(c) Designated person information;

(1) Name, address, and telephone number; and

(2) Experience and qualifications.

[67 FR 38887, June 6, 2002, as amended at 78 FR 58823, Sept. 24, 2013]

**§ 822.10 What must I include in my surveillance plan?**

Your surveillance plan must include a discussion of:

(a) The plan objective(s) addressing the surveillance question(s) identified in our order;

(b) The subject of the study, e.g., patients, the device, animals;

## § 822.11

(c) The variables and endpoints that will be used to answer the surveillance question, e.g., clinical parameters or outcomes;

(d) The surveillance approach or methodology to be used;

(e) Sample size and units of observation;

(f) The investigator agreement, if applicable;

(g) Sources of data, e.g., hospital records;

(h) The data collection plan and forms;

(i) The consent document, if applicable;

(j) Institutional Review Board information, if applicable;

(k) The patient followup plan, if applicable;

(l) The procedures for monitoring conduct and progress of the surveillance;

(m) An estimate of the duration of surveillance;

(n) All data analyses and statistical tests planned;

(o) The content and timing of reports.

### **§ 822.11 What should I consider when designing my plan to conduct postmarket surveillance?**

You must design your surveillance to address the postmarket surveillance question identified in the order you received. You should consider what, if any, patient protection measures should be incorporated into your plan. You should also consider the function, operating characteristics, and intended use of your device when designing a surveillance approach.

### **§ 822.12 Do you have any information that will help me prepare my submission or design my postmarket surveillance plan?**

Guidance documents that discuss our current thinking on preparing a postmarket surveillance submission and designing a postmarket surveillance plan are available on the Center for Devices and Radiological Health's Web site and from the Food and Drug Administration, Center for Devices and Radiological Health, Office of Surveillance and Biometrics, 10903 New Hampshire Ave., Bldg. 66, rm. 3219, Silver Spring, MD 20993-0002. Guidance docu-

## 21 CFR Ch. I (4-1-20 Edition)

ments represent our current interpretation of, or policy on, a regulatory issue. They do not establish legally enforceable rights or responsibilities and do not legally bind you or FDA. You may choose to use an approach other than the one set forth in a guidance document, as long as your alternative approach complies with the relevant statutes (laws) and regulations. If you wish, we will meet with you to discuss whether an alternative approach you are considering will satisfy the requirements of the act and regulations.

[75 FR 20915, Apr. 22, 2010]

### **§ 822.13 [Reserved]**

### **§ 822.14 May I reference information previously submitted instead of submitting it again?**

Yes, you may reference information that you have submitted in premarket submissions as well as other postmarket surveillance submissions. You must specify the information to be incorporated and the document number and pages where the information is located.

### **§ 822.15 How long must I conduct postmarket surveillance of my device?**

The length of postmarket surveillance will depend on the postmarket surveillance question identified in our order. We may order prospective surveillance for a period up to 36 months; longer periods require your agreement. If we believe that a prospective period of greater than 36 months is necessary to address the surveillance question, and you do not agree, we will use the Medical Devices Dispute Resolution Panel to resolve the matter. You may obtain guidance regarding dispute resolution procedures from the Center for Devices and Radiological Health's (CDRH) Web site (<http://www.fda.gov/AboutFDA/CentersOffices/OfficeofMedicalProductsandTobacco/CDRH/CDRHombudsman/default.htm>). The 36-month period refers to the surveillance period, not the length of time from the issuance of the order.

[72 FR 17400, Apr. 9, 2007, as amended at 78 FR 18233, Mar. 26, 2013]



**Subpart D—FDA Review and Action**

**§ 822.16 What will you consider in the review of my submission?**

First, we will determine that the submission is administratively complete. Then, in accordance with the law, we must determine whether the designated person has appropriate qualifications and experience to conduct the surveillance and whether the surveillance plan will result in the collection

of useful data that will answer the surveillance question.

**§ 822.17 How long will your review of my submission take?**

We will review your submission within 60 days of receipt.

**§ 822.18 How will I be notified of your decision?**

We will send you a letter notifying you of our decision and identifying any action you must take.

**§ 822.19 What kinds of decisions may you make?**

If your plan:	Then we will send you:	And you must:
(a) Should result in the collection of useful data that will address the postmarket surveillance question	An approval order, identifying any specific requirements related to your postmarket surveillance	Conduct postmarket surveillance of your device in accordance with the approved plan
(b) Should result in the collection of useful data that will address the postmarket surveillance question after specific revisions are made or specific information is provided	An approvable letter identifying the specific revisions or information that must be submitted before your plan can be approved	Revise your postmarket surveillance submission to address the concerns in the approvable letter and submit it to us within the specified timeframe. We will determine the timeframe case-by-case, based on the types of revisions or information that you must submit
(c) Does not meet the requirements specified in this part	A letter disapproving your plan and identifying the reasons for disapproval	Revise your postmarket surveillance submission and submit it to us within the specified timeframe. We will determine the timeframe case-by-case, based on the types of revisions or information that you must submit
(d) Is not likely to result in the collection of useful data that will address the postmarket surveillance question	A letter disapproving your plan and identifying the reasons for disapproval	Revise your postmarket surveillance submission and submit it to us within the specified timeframe. We will determine the timeframe case-by-case, based on the types of revisions or information that you must submit

**§ 822.20 What are the consequences if I fail to submit a postmarket surveillance plan, my plan is disapproved and I fail to submit a new plan, or I fail to conduct surveillance in accordance with my approved plan?**

The failure to have an approved postmarket surveillance plan or failure to conduct postmarket surveillance in accordance with the approved plan constitutes failure to comply with section 522 of the act. Your failure would be a prohibited act under section 301(q)(1)(C) of the act, and your device would be misbranded under section 502(t)(3) of the act. We have the authority to initiate actions against products that are adulterated or misbranded,

and against persons who commit prohibited acts. Adulterated or misbranded devices can be seized. Persons who commit prohibited acts can be enjoined from committing such acts, required to pay civil money penalties, or prosecuted.

**§ 822.21 What must I do if I want to make changes to my postmarket surveillance plan after you have approved it?**

You must receive our approval in writing before making changes in your plan that will affect the nature or validity of the data collected in accordance with the plan. To obtain our approval, you must submit three copies of the request to make the proposed

change and revised postmarket surveillance plan to the applicable address listed in § 822.8. You may reference information already submitted in accordance with § 822.14. In your cover letter, you must identify your submission as a supplement and cite the unique document number that we assigned in our acknowledgment letter for your original submission, specifically identify the changes to the plan, and identify the reasons and justification for making the changes. You must report changes in your plan that will not affect the nature or validity of the data collected in accordance with the plan in the next interim report required by your approval order.

**§ 822.22 What recourse do I have if I do not agree with your decision?**

(a) If you disagree with us about the content of your plan or if we disapprove your plan, or if you believe there is a less burdensome approach that will answer the surveillance question, you may request review of our decision by:

(1) Requesting a meeting with the Director, Office of Surveillance and Biometrics, Center for Devices and Radiological Health (CDRH), who generally issues the order for postmarket surveillance;

(2) Seeking internal review of the order under § 10.75 of this chapter;

(3) Requesting an informal hearing under part 16 of this chapter; or

(4) Requesting review by the Medical Devices Dispute Resolution Panel of the Medical Devices Advisory Committee.

(b) You may obtain guidance documents that discuss these mechanisms from the Center for Devices and Radiological Health's (CDRH's) Web site.

[67 FR 38887, June 6, 2002, as amended at 72 FR 17400, Apr. 9, 2007]

**§ 822.23 Is the information in my submission considered confidential?**

We consider the content of your submission confidential until we have approved your postmarket surveillance plan. After we have approved your plan, the contents of the original submission and any amendments, supplements, or reports may be disclosed in accordance with the Freedom of Infor-

mation Act. We will continue to protect trade secret and confidential commercial information after your plan is approved. We will not disclose information identifying individual patients. You may wish to indicate in your submission which information you consider trade secret or confidential commercial.

**Subpart E—Responsibilities of Manufacturers**

**§ 822.24 What are my responsibilities once I am notified that I am required to conduct postmarket surveillance?**

You must submit your plan to conduct postmarket surveillance to us within 30 days from receipt of the order (letter) notifying you that you are required to conduct postmarket surveillance of a device.

**§ 822.25 What are my responsibilities after my postmarket surveillance plan has been approved?**

After we have approved your plan, you must conduct the postmarket surveillance of your device in accordance with your approved plan. This means that you must ensure that:

(a) Postmarket surveillance is initiated in a timely manner;

(b) The surveillance is conducted with due diligence;

(c) The data identified in the plan is collected;

(d) Any reports required as part of your approved plan are submitted to us in a timely manner; and

(e) Any information that we request prior to your submission of a report or in response to our review of a report is provided in a timely manner.

**§ 822.26 If my company changes ownership, what must I do?**

You must notify us within 30 days of any change in ownership of your company. Your notification should identify any changes to the name or address of the company, the contact person, or the designated person (as defined in § 822.3(b)). Your obligation to conduct postmarket surveillance will generally transfer to the new owner, unless you and the new owner have both agreed that you will continue to conduct the

surveillance. If you will continue to conduct the postmarket surveillance, you still must notify us of the change in ownership.

**§ 822.27 If I go out of business, what must I do?**

You must notify us within 30 days of the date of your decision to close your business. You should provide the expected date of closure and discuss your plans to complete or terminate postmarket surveillance of your device. You must also identify who will retain the records related to the surveillance (described in subpart G of this part) and where the records will be kept.

**§ 822.28 If I stop marketing the device subject to postmarket surveillance, what must I do?**

You must continue to conduct postmarket surveillance in accordance with your approved plan even if you no longer market the device. You may request that we allow you to terminate postmarket surveillance or modify your postmarket surveillance because you no longer market the device. We will make these decisions on a case-by-case basis, and you must continue to conduct the postmarket surveillance unless we notify you that you may stop your surveillance study.

**Subpart F—Waivers and Exemptions**

**§ 822.29 May I request a waiver of a specific requirement of this part?**

You may request that we waive any specific requirement of this part. You may submit your request, with supporting documentation, separately or as a part of your postmarket surveillance submission to the address in § 822.8.

**§ 822.30 May I request exemption from the requirement to conduct postmarket surveillance?**

You may request exemption from the requirement to conduct postmarket surveillance for your device or any specific model of that device at any time. You must comply with the requirements of this part unless and until we grant an exemption for your device.

Your request for exemption must explain why you believe we should exempt the device or model from postmarket surveillance. You should demonstrate why the surveillance question does not apply to your device or does not need to be answered for the device for which you are requesting exemption. Alternatively, you may provide information that answers the surveillance question for your device, with supporting documentation, to the address in § 822.8.

**Subpart G—Records and Reports**

**§ 822.31 What records am I required to keep?**

You must keep copies of:

(a) All correspondence with your investigators or FDA, including required reports;

(b) Signed agreements from each of your investigators, if your surveillance plan uses investigators, stating the commitment to conduct the surveillance in accordance with the approved plan, any applicable FDA regulations, and any conditions of approval for your plan, such as reporting requirements;

(c) Your approved postmarket surveillance plan, with documentation of the date and reason for any deviation from the plan;

(d) All data collected and analyses conducted in support of your postmarket surveillance plan; and

(e) Any other records that we require to be maintained by regulation or by order, such as copies of signed consent documents, evidence of Institutional Review Board review and approval, etc.

**§ 822.32 What records are the investigators in my surveillance plan required to keep?**

Your investigator must keep copies of:

(a) All correspondence between investigators, FDA, the manufacturer, and the designated person, including required reports.

(b) The approved postmarket surveillance plan, with documentation of the date and reason for any deviation from the plan.

(c) All data collected and analyses conducted at that site for postmarket surveillance.

## § 822.33

(d) Any other records that we require to be maintained by regulation or by order.

### § 822.33 How long must we keep the records?

You, the designated person, and your investigators must keep all records for a period of 2 years after we have accepted your final report, unless we specify otherwise.

### § 822.34 What must I do with the records if the sponsor of the plan or an investigator in the plan changes?

If the sponsor of the plan or an investigator in the plan changes, you must ensure that all records related to the postmarket surveillance have been transferred to the new sponsor or investigator and notify us within 10 working days of the effective date of the change. You must provide the name, address, and telephone number of the new sponsor or investigator, certify that all records have been transferred, and provide the date of transfer.

### § 822.35 Can you inspect my manufacturing site or other sites involved in my postmarket surveillance plan?

We can review your postmarket surveillance programs during regularly scheduled inspections, inspections initiated to investigate recalls or other similar actions, and inspections initiated specifically to review your postmarket surveillance plan. We may also inspect any other person or site involved in your postmarket surveillance, such as investigators or contractors. Any person authorized to grant access to a facility must permit authorized FDA employees to enter and inspect any facility where the device is held or where records regarding postmarket surveillance are held.

### § 822.36 Can you inspect and copy the records related to my postmarket surveillance plan?

We may, at a reasonable time and in a reasonable manner, inspect and copy any records pertaining to the conduct of postmarket surveillance that are required to be kept by this regulation. You must be able to produce records and information required by this regulation that are in the possession of oth-

## 21 CFR Ch. I (4–1–20 Edition)

ers under contract with you to conduct the postmarket surveillance. Those who have signed agreements or are under contract with you must also produce the records and information upon our request. This information must be produced within 72 hours of the initiation of the inspection. We generally will redact information pertaining to individual subjects prior to copying those records, unless there are extenuating circumstances.

### § 822.37 Under what circumstances would you inspect records identifying subjects?

We can inspect and copy records identifying subjects under the same circumstances that we can inspect any records relating to postmarket surveillance. We are likely to be interested in such records if we have reason to believe that required reports have not been submitted, or are incomplete, inaccurate, false, or misleading.

### § 822.38 What reports must I submit to you?

You must submit interim and final reports as specified in your approved postmarket surveillance plan. In addition, we may ask you to submit additional information when we believe that the information is necessary for the protection of the public health and implementation of the act. We will also state the reason or purpose for the request and how we will use the information.

## PART 830—UNIQUE DEVICE IDENTIFICATION

### Subpart A—General Provisions

830.3 Definitions.

### Subpart B—Requirements for a Unique Device Identifier

Sec.

830.10 Incorporation by reference.

830.20 Requirements for a unique device identifier.

830.40 Use and discontinuation of a device identifier.

830.50 Changes that require use of a new device identifier.

830.60 Relabeling of a device that is required to bear a unique device identifier.

**Subpart C—FDA Accreditation of an Issuing Agency**

- 830.100 FDA accreditation of an issuing agency.
- 830.110 Application for accreditation as an issuing agency.
- 830.120 Responsibilities of an FDA-accredited issuing agency.
- 830.130 Suspension or revocation of the accreditation of an issuing agency.

**Subpart D—FDA as an Issuing Agency**

- 830.200 When FDA will act as an issuing agency.
- 830.210 Eligibility for use of FDA as an issuing agency.
- 830.220 Termination of FDA service as an issuing agency.

**Subpart E—Global Unique Device Identification Database**

- 830.300 Devices subject to device identification data submission requirements.
- 830.310 Information required for unique device identification.
- 830.320 Submission of unique device identification information.
- 830.330 Times for submission of unique device identification information.
- 830.340 Voluntary submission of ancillary device identification information.
- 830.350 Correction of information submitted to the Global Unique Device Identification Database.
- 830.360 Records to be maintained by the labeler.

AUTHORITY: 21 U.S.C. 321, 331, 352, 353, 360, 360d, 360i, 360j, 371.

SOURCE: 78 FR 58823, Sept. 24, 2013, unless otherwise noted.

**Subpart A—General Provisions**

SOURCE: 78 FR 58825, Sept. 24, 2013, unless otherwise noted.

**§ 830.3 Definitions.**

As used in this part:

*Automatic identification and data capture (AIDC)* means any technology that conveys the unique device identifier or the device identifier of a device in a form that can be entered into an electronic patient record or other computer system via an automated process.

*Center Director* means the Director of the Center for Devices and Radiological Health or the Director of the Center for Biologics Evaluation and

Research, depending on which Center has been assigned lead responsibility for the device.

*Device package* means a package that contains a fixed quantity of a particular version or model of a device.

*Expiration date* means the date by which the label of a device states the device must or should be used.

*FDA, we, or us* means the Food and Drug Administration.

*Federal Food, Drug, and Cosmetic Act* means 21 U.S.C. 321 *et seq.*, as amended.

*Finished device* means any device or accessory to any device that is suitable for use or capable of functioning.

*Global Unique Device Identification Database (GUDID)* means the database that serves as a repository of information to facilitate the identification of medical devices through their distribution and use.

*Human cell, tissue, or cellular or tissue-based product (HCT/P) regulated as a device* means an HCT/P as defined in § 1271.3(d) of this chapter that does not meet the criteria in § 1271.10(a) and that is also regulated as a device.

*Issuing agency* means an organization accredited by FDA to operate a system for the issuance of unique device identifiers.

*Label* has the meaning set forth in section 201(k) of the Federal Food, Drug, and Cosmetic Act.

*Labeler* means:

(1) Any person who causes a label to be applied to a device with the intent that the device will be commercially distributed without any subsequent replacement or modification of the label; and

(2) Any person who causes the label of a device to be replaced or modified with the intent that the device will be commercially distributed without any subsequent replacement or modification of the label, except that the addition of the name of, and contact information for, a person who distributes the device, without making any other changes to the label, is not a modification for the purposes of determining whether a person is a labeler.

*Lot or batch* means one *finished device* or more that consist of a single type, model, class, size, composition, or software version that are manufactured under essentially the same conditions

and that are intended to have uniform characteristics and quality within specified limits.

*Shipping container* means a container used during the shipment or transportation of devices, and whose contents may vary from one shipment to another.

*Small business* means a medical device manufacturer with 500 or fewer employees, or a medical device relabeler or repackager with 100 or fewer employees.

*Specification* means any requirement with which a device must conform.

*Unique device identifier (UDI)* means an identifier that adequately identifies a device through its distribution and use by meeting the requirements of § 830.20. A UDI is composed of:

- (1) A *device identifier*—a mandatory, fixed portion of a UDI that identifies the specific version or model of a device and the labeler of that device; and
- (2) A *production identifier*—a conditional, variable portion of a UDI that identifies one or more of the following when included on the label of the device:
  - (i) The lot or batch within which a device was manufactured;
  - (ii) The serial number of a specific device;
  - (iii) The expiration date of a specific device;
  - (iv) The date a specific device was manufactured.

- (v) For an HCT/P regulated as a device, the distinct identification code required by § 1271.290(c) of this chapter.

*Universal product code (UPC)* means the product identifier used to identify an item sold at retail in the United States.

*Version or model* means all devices that have specifications, performance, size, and composition, within limits set by the labeler.

### Subpart B—Requirements for a Unique Device Identifier

#### § 830.10 Incorporation by reference.

(a) Certain material is incorporated by reference into this part with the approval of the Director of the Federal Register in accordance with 5 U.S.C. 552(a) and 1 CFR part 51. To enforce any edition other than that specified in

this section, the Food and Drug Administration must publish notice of change in the FEDERAL REGISTER and the material must be available to the public. All approved material is available for inspection at the Division of Dockets Management (HFA-305), Food and Drug Administration, 5630 Fishers Lane, rm. 1061, Rockville, MD 20852, 301-827-6860, and is available from the source listed in paragraph (b) of this section. Copies are also available for purchase from the American National Standards Institute (ANSI), mailing address: ANSI, Attn: Customer Service Department, 25 West 43rd St., 4th floor, New York, NY 10036, phone: 212-642-4980, and may be ordered online at <http://webstore.ansi.org/>. The material is also available for inspection at the National Archives and Records Administration (NARA). For information on the availability of this material at NARA, call 202-741-6030 or go to: [http://www.archives.gov/federal\\_register/code\\_of\\_federal\\_regulations/ibr\\_locations.html](http://www.archives.gov/federal_register/code_of_federal_regulations/ibr_locations.html).

(b) International Organization for Standardization (ISO), mailing address: ISO, Attn: ISO Central Secretariat, 1, ch. de la Voie-Creuse, Case postale 56, CH-1211 Geneva 20, Switzerland, phone (dialing from the United States): 011-41-22-749-0111, and may be ordered online at <http://www.standardsinfo.net>.

(1) ISO/IEC 646:1991(E), Information technology—ISO 7-bit coded character set for information interchange (third edition; December 15, 1991), into §§ 830.20(c) and 830.100(b);

(2) ISO/IEC 15459-2:2006(E), Information technology—Unique identifiers—Part 2: Registration procedures (second edition; March 1, 2006), into §§ 830.20(b) and 830.100(b);

(3) ISO/IEC 15459-4:2008(E), Information technology—Unique identifiers—Part 4: Individual items (second edition; July 15, 2008), into §§ 830.20(b) and 830.100(b);

(4) ISO/IEC 15459-6:2007(E), Information technology—Unique identifiers—Part 6: Unique identifier for product groupings (first edition; June 15, 2007), into §§ 830.20(b) and 830.100(b).

**§ 830.20 Requirements for a unique device identifier.**

A unique device identifier (UDI) must:

(a) Be issued under a system operated by FDA or an FDA-accredited issuing agency;

(b) Conform to each of the following international standards:

(1) ISO/IEC 15459-2, which is incorporated by reference at § 830.10;

(2) ISO/IEC 15459-4, which is incorporated by reference at § 830.10; and

(3) ISO/IEC 15459-6, which is incorporated by reference at § 830.10.

(c) Use only characters and numbers from the invariant character set of ISO/IEC 646, which is incorporated by reference at § 830.10.

[78 FR 58825, Sept. 24, 2013]

**§ 830.40 Use and discontinuation of a device identifier.**

(a) Only one device identifier from any particular system for the issuance of unique device identifiers (UDIs) may be used to identify a particular version or model of a device. A particular version or model may be identified by UDIs from two or more systems for the issuance of UDIs.

(b) A device identifier shall be used to identify only one version or model.

(c) In the event that a version or model of a device is discontinued, its device identifier may not be reassigned to another device. If a discontinued version or model is re-introduced and no changes have been made that would require the use of a new device identifier, the device identifier that was previously in use may be used to identify the device.

(d) In the event that an issuing agency relinquishes or does not renew its accreditation, you may continue to use a previously issued UDI until such time as § 830.50 requires you to assign a new device identifier.

[78 FR 58825, Sept. 24, 2013]

**§ 830.50 Changes that require use of a new device identifier.**

(a) Whenever you make a change to a device that is required to bear a unique device identifier (UDI) on its label, and the change results in a new version or

model, you must assign a new device identifier to the new version or model.

(b) Whenever you create a new device package, you must assign a new device identifier to the new device package.

[78 FR 58825, Sept. 24, 2013]

**§ 830.60 Relabeling of a device that is required to bear a unique device identifier.**

If you relabel a device that is required to bear a unique device identifier (UDI), you must:

(a) Assign a new device identifier to the device, and

(b) Keep a record showing the relationship of the prior device identifier to your new device identifier.

[78 FR 58825, Sept. 24, 2013]

**Subpart C—FDA Accreditation of an Issuing Agency****§ 830.100 FDA accreditation of an issuing agency.**

(a) *Eligibility.* A private organization may apply for accreditation as an issuing agency.

(b) *Accreditation criteria.* FDA may accredit an organization as an issuing agency, if the system it will operate:

(1) Will employ unique device identifiers (UDIs) that meet the requirements of this part to adequately identify a device through its distribution and use;

(2) Conforms to each of the following international standards:

(i) ISO/IEC 15459-2, which is incorporated by reference at § 830.10;

(ii) ISO/IEC 15459-4, which is incorporated by reference at § 830.10;

(iii) ISO/IEC 15459-6, which is incorporated by reference at § 830.10.

(3) Uses only characters and numbers from the invariant character set of ISO/IEC 646, which is incorporated by reference at § 830.10.

(4) Will be available to all users according to a single set of consistent, fair, and reasonable terms and conditions.

(5) Will protect against conflicts of interest between the issuing agency (and its officers, employees, and other agents) and labelers (and their officers, employees, and other agents) seeking

to use UDIs that may impede the applicant's ability to independently operate a fair and neutral identifier system.

**§ 830.110 Application for accreditation as an issuing agency.**

(a) *Application for initial accreditation.*

(1) An applicant seeking initial FDA accreditation as an issuing agency shall notify FDA of its desire to be accredited by sending a notification by email to: *GUDIDSupport@fda.hhs.gov*, or by correspondence to: UDI Regulatory Policy Support, Center for Devices and Radiological Health, Food and Drug Administration, 10903 New Hampshire Ave., Bldg. 66, Rm. 3303, Silver Spring, MD 20993-0002.

(2) FDA will provide the applicant with additional information to aid in submission of an application for approval as an issuing agency, together with an email address for submission of an application.

(3) The applicant shall furnish to FDA, via email to the email address provided in paragraph (a)(1) of this section, an application containing the following information, materials, and supporting documentation:

(i) Name, address, and phone number of the applicant;

(ii) Detailed descriptions of any standards or criteria the applicant will apply to participating labelers;

(iii) A detailed description of the guidelines that govern assignment of a unique device identifier (UDI) to a device;

(iv) A detailed description of the review and decisionmaking process the applicant will apply when determining whether a particular labeler may use the applicant's UDI system, including:

(A) Copies of the application forms, guidelines, instructions, and other materials the applicant will send to medical device labelers who wish to use the applicant's unique device identification system;

(B) Policies and procedures for notifying a labeler of deficiencies in its use of UDIs;

(C) Procedures for monitoring a labeler's correction of deficiencies in its use of UDIs;

(D) Policies and procedures for suspending or revoking a labeler's use of

the applicant's UDI system, including any appeals process.

(v) Description of the applicant's electronic data management system with respect to its review and decision processes and the applicant's ability to provide electronic data in a format compatible with FDA data systems;

(vi) Fee schedules, if any, together with an explanation of any fee waivers or reductions that are available;

(vii) Detailed information regarding any financial or other relationship between the applicant and any labeler(s) or governmental entity(ies); and

(viii) Other information required by FDA to clarify the application for accreditation.

(b) *Application for renewal of accreditation.* An accredited issuing agency that intends to continue to serve as an issuing agency beyond its current term shall apply to FDA for renewal or notify FDA of its plans not to apply for renewal in accordance with the following procedures and schedule:

(1) At least 9 months before the date of expiration of its accreditation, an issuing agency shall inform FDA, at the address given in paragraph (a)(1) of this section, of its intent to seek renewal.

(2) FDA will notify the issuing agency of the relevant information, materials, and supporting documentation that we will require the issuing agency to submit as part of the renewal procedure. We will tailor these requirements to reflect our experience with the issuing agency during the current and any prior period of accreditation. We will limit our request to the types of the information required by paragraph (a)(3) of this section, and we will require less information if experience shows that we need only a subset of that information.

(3) At least 6 months before the date of expiration of its accreditation, an issuing agency shall furnish to FDA, at the email address we provide, a copy of a renewal application containing the information, materials, and supporting documentation requested by FDA in accordance with paragraph (b)(2) of this section.

(4) Any issuing agency that does not plan to renew its accreditation shall so notify FDA at the address given in



paragraph (a)(1) of this section at least 9 months before the expiration of the issuing agency's term of accreditation and shall include a description of its plans for allowing continued use of UDIs issued prior to the expiration of the current term of accreditation.

(c) *FDA action on an application for initial or renewal accreditation.* (1) FDA will conduct a review and evaluation to determine whether the applicant meets the requirements of this subpart and whether the UDI system proposed by the applicant will meet the requirements of this subpart.

(2) Within 60 days of receipt of an application for accreditation, FDA will notify the applicant of any deficiencies in its application and will request correction of those deficiencies within 60 days. The applicant may request an extension if it needs additional time to correct deficiencies in its application. If the deficiencies are not resolved to FDA's satisfaction within the specified time period, the application for accreditation as an issuing agency may be denied.

(3) FDA shall notify the applicant whether the application for accreditation has been granted or denied. That notification shall list any conditions of approval or state the reasons for denial.

(4) If FDA denies an application, we will advise the applicant of the circumstances under which a denied application may be resubmitted.

(5) If FDA does not reach a final decision on a renewal application before the expiration of an issuing agency's current accreditation, the approval will be deemed extended until FDA reaches a final decision on the application.

(d) *Relinquishment of accreditation.* If an issuing agency decides to relinquish its accreditation before expiration of the current term of accreditation, it shall submit a letter of such intent to FDA, at the address provided in paragraph (a)(1) of this section, at least 9 months before relinquishing its accreditation.

(e) *Notice of termination of accreditation.* An issuing agency that does not apply for renewal of its accreditation, is denied renewal of accreditation by FDA, or relinquishes its accreditation

and duties before expiration of the current term of accreditation, shall notify all labelers that are using the issuing agency's UDI system, in a manner and time period approved by FDA, of the date that the issuing agency will cease to serve as an FDA-accredited issuing agency.

(f) *Term of accreditation.* The initial term of accreditation for an issuing agency shall be for a period of 3 years. An issuing agency's term of accreditation may be periodically renewed for a period of 7 years.

[78 FR 58825, Sept. 24, 2013, as amended at 81 FR 11429, Mar. 4, 2016]

#### **§ 830.120 Responsibilities of an FDA-accredited issuing agency.**

To maintain its accreditation, an issuing agency must:

(a) Operate a system for assignment of unique device identifiers (UDIs) that meets the requirements of § 830.20;

(b) Make available information concerning its system for the assignment of UDIs;

(c) Maintain a list of labelers that use its system for the assignment of UDIs and provide FDA a copy of such list in electronic form by December 31 of each year;

(d) Upon request, provide FDA with information concerning a labeler that is employing the issuing agency's system for assignment of UDIs; and

(e) Remain in compliance with the eligibility and accreditation criteria set forth in § 830.100.

#### **§ 830.130 Suspension or revocation of the accreditation of an issuing agency.**

FDA may suspend or revoke the accreditation of an issuing agency if FDA finds, after providing the issuing agency with notice and opportunity for an informal hearing in accordance with part 16 of this chapter, that the issuing agency or any officer, employee, or other agent of the issuing agency:

(a) Has been guilty of misrepresentation or failure to disclose required information in obtaining accreditation;

(b) Has failed to fulfill the responsibilities outlined in § 830.120;

(c) Has failed to protect against conflicts of interest that may impede the

## § 830.200

issuing agency's ability to independently operate a fair and neutral identifier system;

(d) In the operation of the issuing agency, has engaged in any anti-competitive activity to restrain trade; or

(e) Has violated or aided and abetted in the violation of any regulation issued under section 510(e) or section 519(f) of the Federal Food, Drug, and Cosmetic Act.

### Subpart D—FDA as an Issuing Agency

SOURCE: 78 FR 58826, Sept. 24, 2013, unless otherwise noted.

#### § 830.200 When FDA will act as an issuing agency.

(a) During any period where there is no accredited issuing agency, FDA will act as an issuing agency.

(b) If FDA determines that a significant number of small businesses would be substantially and adversely affected by the fees required by all accredited issuing agencies, FDA will act as an issuing agency.

(c) FDA may, in its discretion, act as an issuing agency if we determine it is necessary for us to do so to ensure the continuity or the effectiveness of the system for the identification of medical devices.

(d) FDA may, in its discretion, act as an issuing agency if we determine it is appropriate for us to do so in order to facilitate or implement an alternative granted under § 801.55 of this chapter.

#### § 830.210 Eligibility for use of FDA as an issuing agency.

When FDA acts as an issuing agency, any labeler will be permitted to use FDA's unique device identification system, regardless of whether the labeler is considered a small business.

#### § 830.220 Termination of FDA service as an issuing agency.

(a) FDA may end our services as an issuing agency if we determine that the conditions that prompted us to act no longer exist and that ending our services would not be likely to lead to a return of the conditions that prompted us to act.

## 21 CFR Ch. I (4–1–20 Edition)

(b) If FDA has ended our services as an issuing agency, a labeler may continue to use a device identifier assigned under FDA's unique device identification system until such time as § 830.50 requires the use of a new device identifier.

### Subpart E—Global Unique Device Identification Database

SOURCE: 78 FR 58826, Sept. 24, 2013, unless otherwise noted.

#### § 830.300 Devices subject to device identification data submission requirements.

(a) *In general.* The labeler of a device must provide the information required by this subpart for each version or model required to bear a unique device identifier (UDI).

(b) *Voluntary submission of information.* If a labeler voluntarily includes a UDI on the label of a device under § 801.40, the labeler may also voluntarily submit information concerning that device under this part.

(c) *Exclusions.* FDA may reject or remove any device identification data where:

(1) The device identifier submitted does not conform to § 830.20;

(2) The information concerns a device that is neither manufactured in the United States nor in interstate commerce in the United States,

(3) The information concerns a product that FDA determines is not a device or a combination product that includes a device constituent part,

(4) The information concerns a device or a combination product that requires, but does not have, FDA pre-market approval, licensure, or clearance;

(5) A device that FDA has banned under section 516 of the Federal Food, Drug, and Cosmetic Act; or

(6) FDA has suspended the accreditation of the issuing agency that operates the system used by the labeler.

#### § 830.310 Information required for unique device identification.

The contact for device identification designated under § 830.320(a) shall provide FDA with the following information concerning each version or model

of a device required to bear a unique device identifier (UDI) on its label:

(a) *Concerning the labeler:*

(1) The name of the labeler;

(2) A telephone number or email address that will allow FDA to communicate with the contact for device identification designated under § 830.320(a); and

(3) The name of each issuing agency whose system is used by the labeler to assign UDIs used by the labeler.

(b) *Concerning each version or model of a device with a UDI on its label:*

(1) The device identifier portion of the UDI assigned to the version or model;

(2) When reporting a substitution of a new device identifier that will be used in lieu of a previously reported identifier, the device identifier that was previously assigned to the version or model;

(3) If § 801.45 of this chapter requires the device to bear a UDI as a permanent marking on the device itself, either:

(i) A statement that the device identifier that appears as a permanent marking on the device is identical to that reported under paragraph (b)(1) of this section, or

(ii) The device identifier portion of the UDI that appears as a permanent marking on the device;

(4) The proprietary, trade, or brand name of the device as it appears on the label of the device;

(5) Any version or model number or similar reference that appears on the label of the device;

(6) If the device is labeled as sterile, a statement to that effect;

(7) If the device is labeled as containing natural rubber latex that contacts humans, or is labeled as having packaging containing natural rubber latex that contacts humans, as described by §§ 801.437(b)(1), 801.437(b)(3), and 801.437(f) of this chapter, a statement to that effect;

(8) Whether a patient may be safely exposed to magnetic resonance imaging, nuclear magnetic resonance imaging, or magnetic resonance tomography while using the device, or while the device is implanted in patient.

(9) If the device is available in more than one size, the size of the particular

version or model, together with the unit of measure, as it appears on the label of the device;

(10) The type of production identifiers that appear on the label of the device;

(11) The FDA premarket submission number of a cleared or approved device, or a statement that FDA has by regulation exempted the device from premarket notification;

(12) The FDA listing number assigned to the device;

(13) The Global Medical Device Nomenclature (GMDN) term or code for the device;

(14) The total number of individual devices contained in the device package.

**§ 830.320 Submission of unique device identification information.**

(a) *Designation of contact for device identification.* Each labeler must designate an individual to serve as the point of contact with FDA on matters relating to the identification of medical devices marketed by the labeler. The contact for device information is responsible for ensuring FDA is provided with all information required by this part. The contact for device information may authorize an issuing agency or any other person to provide information to FDA on behalf of the labeler.

(b) *Information shall be submitted via electronic means.* All information required by this subpart shall be submitted electronically to FDA's Global Unique Device Identification Database (GUDID) in a format that we can process, review, and archive, unless the labeler has obtained a waiver from electronic submission of unique device identifier (UDI) data.

(c) *Waiver from electronic submission.*

(1) A labeler may request a waiver from electronic submission of UDI data by submitting a letter addressed to the appropriate Center Director explaining why electronic submission is not technologically feasible; send the request by email to: [udi@fda.hhs.gov](mailto:udi@fda.hhs.gov), or by correspondence to: UDI Regulatory Policy Support, Center for Devices and Radiological Health, Food and Drug Administration, Bldg. 66, Rm. 3303, 10903 New Hampshire Ave., Silver Spring, MD 20993-0002.

### § 830.330

### 21 CFR Ch. I (4–1–20 Edition)

(2) If the establishment where the labeler is located has obtained a waiver from electronic submission of registration and listing information under section 510(p) of the Federal Food, Drug, and Cosmetic Act, the labeler is deemed to have a waiver from electronic submission of UDI data.

(3) A labeler that has a waiver from electronic submission of UDI data must send a letter containing all of the information required by § 830.310, as well as any ancillary information permitted to be submitted under § 830.340 that the labeler wishes to submit, within the time permitted by § 830.330, addressed to: UDI Regulatory Policy Support, Center for Devices and Radiological Health, Food and Drug Administration, Bldg. 66, Rm. 3303, 10903 New Hampshire Ave., Silver Spring, MD 20993–0002.

#### **§ 830.330 Times for submission of unique device identification information.**

(a) The labeler shall submit to FDA the information required by § 830.310 no later than the date the label of the device must bear a unique device identifier under § 801.20 of this chapter.

(b) The labeler of a device shall submit to FDA an update to the information required by § 830.310 whenever the information changes. The updated information must be submitted no later than the date a device is first labeled with the changed information. If the information does not appear on the label of a device, the updated information must be submitted within 10 business days of the change.

#### **§ 830.340 Voluntary submission of ancillary device identification information.**

(a) You may not submit any information to the Global Unique Device Identification Database (GUDID) other than that specified by § 830.310, except where FDA acts to permit the submission of specified additional types of information, termed ancillary information.

(b) FDA will provide information through the FDA Web site at <http://www.fda.gov/udi/> concerning the types of ancillary information that may be submitted to the GUDID.

(c) FDA may periodically change the types of ancillary information that may be submitted to the GUDID. We will announce any change on the FDA Web site at <http://www.fda.gov/udi/> at least 60 days before making the change.

#### **§ 830.350 Correction of information submitted to the Global Unique Device Identification Database.**

(a) If FDA becomes aware that any information submitted to the Global Unique Device Identification Database (GUDID) appears to be incorrect or potentially misleading, we may notify the labeler of the specific information that appears to be incorrect, and request that the labeler provide corrected information or explain why the information is correct. The labeler must provide corrected information or provide a satisfactory explanation of why the information is correct within 30 days of receipt of FDA's notification.

(b) If the labeler does not respond to FDA's notification within 30 days of receipt, or if FDA determines, at any time, that any information in the GUDID is incorrect or could be misleading, we may delete or correct the information. Any action taken by FDA under this paragraph does not relieve the labeler of its responsibility under paragraph (a) of this section to provide corrected information or an explanation of why the information previously submitted is correct.

#### **§ 830.360 Records to be maintained by the labeler.**

(a) Each labeler shall retain, and submit to FDA upon specific request, records showing all unique device identifiers (UDIs) used to identify devices that must bear a UDI on their label, and the particular version or model associated with each device identifier. These records must be retained for 3 years from the date the labeler ceases to market the version or model.

(b) Compliance with this section does not relieve the labeler of the need to comply with recordkeeping requirements of any other FDA regulation.

## PART 860—MEDICAL DEVICE CLASSIFICATION PROCEDURES

### Subpart A—General

Sec.

- 860.1 Scope.
- 860.3 Definitions.
- 860.5 Confidentiality and use of data and information submitted in connection with classification and reclassification.
- 860.7 Determination of safety and effectiveness.
- 860.10 Implants and life-supporting or life-sustaining devices.
- 860.15 Exemptions from sections 510, 519, and 520(f) of the Federal Food, Drug, and Cosmetic Act.

### Subpart B—Classification

- 860.84 Classification procedures for “preamendments devices.”
- 860.90 Consultation with panels.

### Subpart C—Reclassification

- 860.120 General.
- 860.123 Reclassification petition: Content and form.
- 860.125 Consultation with panels.
- 860.130 General procedures under section 513(e) of the Federal Food, Drug, and Cosmetic Act.
- 860.132 Procedures when the Commissioner initiates a performance standard or pre-market approval proceeding under section 514(b) or 515(b) of the Federal Food, Drug, and Cosmetic Act.
- 860.133 Procedures when the Commissioner initiates a proceeding to require pre-market approval under section 515(b) of the Federal Food, Drug, and Cosmetic Act.
- 860.134 Procedures for reclassification of “postamendments devices” under section 513(f)(3) of the Federal Food, Drug, and Cosmetic Act.
- 860.136 Procedures for transitional products under section 520(l) of the Federal Food, Drug, and Cosmetic Act.

AUTHORITY: 21 U.S.C. 360c, 360d, 360e, 360i, 360j, 371, 374.

SOURCE: 43 FR 32993, July 28, 1978, unless otherwise noted.

EDITORIAL NOTE: Nomenclature changes to part 860 appear at 73 FR 35341, June 23, 2008.

### Subpart A—General

#### § 860.1 Scope.

(a) This part implements sections 513, 514(b), 515(b), and 520(l) of the act with respect to the classification and reclassification

of devices intended for human use.

(b) This part prescribes the criteria and procedures to be used by classification panels in making their recommendations and by the Commissioner in making the Commissioner’s determinations regarding the class of regulatory control (class I, class II, or class III) appropriate for particular devices. Supplementing the general Food and Drug Administration procedures governing advisory committees (part 14 of this chapter), this part also provides procedures for manufacturers, importers, and other interested persons to participate in proceedings to classify and reclassify devices. This part also describes the kind of data required for determination of the safety and effectiveness of a device, and the circumstances under which information submitted to classification panels or to the Commissioner in connection with classification and reclassification proceedings will be available to the public.

#### § 860.3 Definitions.

For the purposes of this part:

(a) *Act* means the Federal Food, Drug, and Cosmetic Act.

(b) *Commissioner* means the Commissioner of Food and Drugs, Food and Drug Administration, United States Department of Health and Human Services, or the Commissioner’s designee.

(c) *Class* means one of the three categories of regulatory control for medical devices, defined below:

(1) *Class I* means the class of devices that are subject to only the general controls authorized by or under sections 501 (adulteration), 502 (misbranding), 510 (registration), 516 (banned devices), 518 (notification and other remedies), 519 (records and reports), and 520 (general provisions) of the act. A device is in class I if (i) general controls are sufficient to provide reasonable assurance of the safety and effectiveness of the device, or (ii) there is insufficient information from which to determine that general controls are sufficient to provide reasonable assurance of the safety and effectiveness of the device or to establish special controls to provide such assurance, but the

device is not life-supporting or life-sustaining or for a use which is of substantial importance in preventing impairment of human health, and which does not present a potential unreasonable risk of illness or injury.

(2) *Class II* means the class of devices that is or eventually will be subject to special controls. A device is in class II if general controls alone are insufficient to provide reasonable assurance of its safety and effectiveness and there is sufficient information to establish special controls, including the promulgation of performance standards, postmarket surveillance, patient registries, development and dissemination of guidance documents (including guidance on the submission of clinical data in premarket notification submissions in accordance with section 510(k) of the act), recommendations, and other appropriate actions as the Commissioner deems necessary to provide such assurance. For a device that is purported or represented to be for use in supporting or sustaining human life, the Commissioner shall examine and identify the special controls, if any, that are necessary to provide adequate assurance of safety and effectiveness and describe how such controls provide such assurance.

(3) *Class III* means the class of devices for which premarket approval is or will be required in accordance with section 515 of the act. A device is in class III if insufficient information exists to determine that general controls are sufficient to provide reasonable assurance of its safety and effectiveness or that application of special controls described in paragraph (c)(2) of this section would provide such assurance and if, in addition, the device is life-supporting or life-sustaining, or for a use which is of substantial importance in preventing impairment of human health, or if the device presents a potential unreasonable risk of illness or injury.

(d) *Implant* means a device that is placed into a surgically or naturally formed cavity of the human body. A device is regarded as an implant for the purpose of this part only if it is intended to remain implanted continuously for a period of 30 days or more, unless the Commissioner determines

otherwise in order to protect human health.

(e) *Life-supporting or life-sustaining device* means a device that is essential to, or that yields information that is essential to, the restoration or continuation of a bodily function important to the continuation of human life.

(f)–(g) [Reserved]

(h) *Classification panel* means one of the several advisory committees established by the Commissioner under section 513 of the act and part 14 of this chapter for the purpose of making recommendations to the Commissioner on the classification and reclassification of devices and for other purposes prescribed by the act or by the Commissioner.

(i) *Generic type of device* means a grouping of devices that do not differ significantly in purpose, design, materials, energy source, function, or any other feature related to safety and effectiveness, and for which similar regulatory controls are sufficient to provide reasonable assurance of safety and effectiveness.

(j) *Petition* means a submission seeking reclassification of a device in accordance with § 860.123.

[43 FR 32993, July 28, 1978, as amended at 57 FR 58403, Dec. 10, 1992; 65 FR 56480, Sept. 19, 2000; 83 FR 64454, Dec. 17, 2018]

**§ 860.5 Confidentiality and use of data and information submitted in connection with classification and reclassification.**

(a) This section governs the availability for public disclosure and the use by the Commissioner of data and information submitted to classification panels or to the Commissioner in connection with the classification or reclassification of devices under this part.

(b) In general, data and information submitted to classification panels in connection with the classification of devices under § 860.84 will be available immediately for public disclosure upon request. However, except as provided by the special rules in paragraph (c) of this section, this provision does not apply to data and information exempt from public disclosure in accordance with part 20 of this chapter: Such data

and information will be available only in accordance with part 20.

(c)(1) Safety and effectiveness data submitted to classification panels or to the Commissioner in connection with the classification of a device under § 860.84, which have not been disclosed previously to the public, as described in § 20.81 of this chapter, shall be regarded as confidential if the device is classified in to class III. Because the classification of a device under § 860.84 may be ascertained only upon publication of a final regulation, all safety and effectiveness data that have not been disclosed previously are not available for public disclosure unless and until the device is classified into class I or II, in which case the procedure in paragraph (c)(2) of this section applies.

(2) Thirty days after publication of a final regulation under § 860.84 classifying a device into class I or class II, safety and effectiveness data submitted for that device that had been regarded as confidential under paragraph (c)(1) of this section will be available for public disclosure and placed on public display in the office of the Division of Dockets Management, Food and Drug Administration unless, within that 30-day period, the person who submitted the data demonstrates that the data still fall within the exemption for trade secrets and confidential commercial information described in § 20.61 of this chapter. Safety and effectiveness data submitted for a device that is classified into class III by regulation in accordance with § 860.84 will remain confidential and unavailable for public disclosure so long as such data have not been disclosed to the public as described in § 20.81 of this chapter.

(3) Because device classification affects generic types of devices, in making determinations under § 860.84 concerning the initial classification of a device, the classification panels and the Commissioner may consider safety and effectiveness data developed for another device in the same generic type, regardless of whether such data are regarded currently as confidential under paragraph (c)(1) of this section.

(d)(1) The fact of its existence and the contents of a petition for reclassification filed in accordance with

§ 860.130 or § 860.132 are available for public disclosure at the time the petition is received by the Food and Drug Administration.

(2) The fact of the existence of a petition for reclassification filed in accordance with § 860.134 or § 860.136 is available for public disclosure at the time the petition is received by the Food and Drug Administration. The contents of such a petition are not available for public disclosure for the period of time following its receipt (not longer than 30 days) during which the petition is reviewed for any deficiencies preventing the Commissioner from making a decision on it. Once it is determined that the petition contains no deficiencies preventing the Commissioner from making a decision on it, the petition will be filed with the Division of Dockets Management and its entire contents will be available for public disclosure and subject to consideration by classification panels and by the Commissioner in making a decision on the petition. If, during this 30-day period of time, the petition is found to contain deficiencies that prevent the Commissioner from making a decision on it, the petitioner will be so notified and afforded an opportunity to correct the deficiencies.

Thirty days after notice to the petitioner of deficiencies in the petition, the contents of the petition will be available for public disclosure unless, within that 30 days, the petitioner submits supplemental material intended to correct the deficiencies in the petition. The Commissioner, in the Commissioner's discretion, may allow withdrawal of a deficient petition during the 30-day period provided for correcting deficiencies. Any supplemental material submitted by the petitioner, together with the material in the original petition, is considered as a new petition. The new petition is reviewed for deficiencies in the same manner as the original petition, and the same procedures for notification and correction of deficiencies are followed. Once the petitioner has corrected the deficiencies, the entire contents of the petition will be available for public disclosure and subject to consideration by classification panels and by the Commissioner in

making a decision on the petition. Deficient petitions which have not been corrected within 180 days after notification of deficiency will be returned to the petitioner and will not be considered further unless resubmitted.

(e) The Commissioner may not disclose, or use as the basis for reclassification of a device from class III to class II, any information reported to or otherwise obtained by the Commissioner under section 513, 514, 515, 516, 518, 519, 520(f), 520(g), or 704 of the act that falls within the exemption described in §20.61 of this chapter for trade secrets and confidential commercial information. The exemption described in §20.61 does not apply to data or information contained in a petition for reclassification submitted in accordance with §860.130 or §860.132, or in a petition submitted in accordance with §860.134 or §860.136 that has been determined to contain no deficiencies that prevent the Commissioner from making a decision on it. Accordingly, all data and information contained in such petitions may be disclosed by the Commissioner and used as the basis for reclassification of a device from class III to class II.

(f) For purposes of this section, safety and effectiveness data include data and results derived from all studies and tests of a device on animals and humans and from all studies and tests of the device itself intended to establish or determine its safety and effectiveness.

**§ 860.7 Determination of safety and effectiveness.**

(a) The classification panels, in reviewing evidence concerning the safety and effectiveness of a device and in preparing advice to the Commissioner, and the Commissioner, in making determinations concerning the safety and effectiveness of a device, will apply the rules in this section.

(b) In determining the safety and effectiveness of a device for purposes of classification, establishment of special controls for class II devices, and pre-market approval of class III devices, the Commissioner and the classification panels will consider the following, among other relevant factors:

(1) The persons for whose use the device is represented or intended;

(2) The conditions of use for the device, including conditions of use prescribed, recommended, or suggested in the labeling or advertising of the device, and other intended conditions of use;

(3) The probable benefit to health from the use of the device weighed against any probable injury or illness from such use; and

(4) The reliability of the device.

(c)(1) Although the manufacturer may submit any form of evidence to the Food and Drug Administration in an attempt to substantiate the safety and effectiveness of a device, the agency relies upon only valid scientific evidence to determine whether there is reasonable assurance that the device is safe and effective. After considering the nature of the device and the rules in this section, the Commissioner will determine whether the evidence submitted or otherwise available to the Commissioner is valid scientific evidence for the purpose of determining the safety or effectiveness of a particular device and whether the available evidence, when taken as a whole, is adequate to support a determination that there is reasonable assurance that the device is safe and effective for its conditions of use.

(2) Valid scientific evidence is evidence from well-controlled investigations, partially controlled studies, studies and objective trials without matched controls, well-documented case histories conducted by qualified experts, and reports of significant human experience with a marketed device, from which it can fairly and responsibly be concluded by qualified experts that there is reasonable assurance of the safety and effectiveness of a device under its conditions of use. The evidence required may vary according to the characteristics of the device, its conditions of use, the existence and adequacy of warnings and other restrictions, and the extent of experience with its use. Isolated case reports, random experience, reports lacking sufficient details to permit scientific evaluation, and unsubstantiated



opinions are not regarded as valid scientific evidence to show safety or effectiveness. Such information may be considered, however, in identifying a device with questionable safety or effectiveness.

(d)(1) There is reasonable assurance that a device is safe when it can be determined, based upon valid scientific evidence, that the probable benefits to health from use of the device for its intended uses and conditions of use, when accompanied by adequate directions and warnings against unsafe use, outweigh any probable risks. The valid scientific evidence used to determine the safety of a device shall adequately demonstrate the absence of unreasonable risk of illness or injury associated with the use of the device for its intended uses and conditions of use.

(2) Among the types of evidence that may be required, when appropriate, to determine that there is reasonable assurance that a device is safe are investigations using laboratory animals, investigations involving human subjects, nonclinical investigations, and analytical studies for in vitro diagnostic devices.

(e)(1) There is reasonable assurance that a device is effective when it can be determined, based upon valid scientific evidence, that in a significant portion of the target population, the use of the device for its intended uses and conditions of use, when accompanied by adequate directions for use and warnings against unsafe use, will provide clinically significant results.

(2) The valid scientific evidence used to determine the effectiveness of a device shall consist principally of well-controlled investigations, as defined in paragraph (f) of this section, unless the Commissioner authorizes reliance upon other valid scientific evidence which the Commissioner has determined is sufficient evidence from which to determine the effectiveness of a device, even in the absence of well-controlled investigations. The Commissioner may make such a determination where the requirement of well-controlled investigations in paragraph (f) of this section is not reasonably applicable to the device.

(f) The following principles have been developed over a period of years and

are recognized by the scientific community as the essentials of a well-controlled clinical investigation. They provide the basis for the Commissioner's determination whether there is reasonable assurance that a device is effective based upon well-controlled investigations and are also useful in assessing the weight to be given to other valid scientific evidence permitted under this section.

(1) The plan or protocol for the study and the report of the results of a well-controlled investigation shall include the following:

(i) A clear statement of the objectives of the study;

(ii) A method of selection of the subjects that:

(a) Provides adequate assurance that the subjects are suitable for the purposes of the study, provides diagnostic criteria of the condition to be treated or diagnosed, provides confirmatory laboratory tests where appropriate and, in the case of a device to prevent a disease or condition, provides evidence of susceptibility and exposure to the condition against which prophylaxis is desired;

(b) Assigns the subjects to test groups, if used, in such a way as to minimize any possible bias;

(c) Assures comparability between test groups and any control groups of pertinent variables such as sex, severity or duration of the disease, and use of therapy other than the test device;

(iii) An explanation of the methods of observation and recording of results utilized, including the variables measured, quantitation, assessment of any subject's response, and steps taken to minimize any possible bias of subjects and observers;

(iv) A comparison of the results of treatment or diagnosis with a control in such a fashion as to permit quantitative evaluation. The precise nature of the control must be specified and an explanation provided of the methods employed to minimize any possible bias of the observers and analysts of the data. Level and methods of "blinding," if appropriate and used, are to be documented. Generally, four types of comparisons are recognized:

(a) *No treatments.* Where objective measurements of effectiveness are

## § 860.10

## 21 CFR Ch. I (4–1–20 Edition)

available and placebo effect is negligible, comparison of the objective results in comparable groups of treated and untreated patients;

(b) *Placebo control.* Where there may be a placebo effect with the use of a device, comparison of the results of use of the device with an ineffective device used under conditions designed to resemble the conditions of use under investigation as far as possible;

(c) *Active treatment control.* Where an effective regimen of therapy may be used for comparison, e.g., the condition being treated is such that the use of a placebo or the withholding of treatment would be inappropriate or contrary to the interest of the patient;

(d) *Historical control.* In certain circumstances, such as those involving diseases with high and predictable mortality or signs and symptoms of predictable duration or severity, or in the case of prophylaxis where morbidity is predictable, the results of use of the device may be compared quantitatively with prior experience historically derived from the adequately documented natural history of the disease or condition in comparable patients or populations who received no treatment or who followed an established effective regimen (therapeutic, diagnostic, prophylactic).

(v) A summary of the methods of analysis and an evaluation of the data derived from the study, including any appropriate statistical methods utilized.

(2) To insure the reliability of the results of an investigation, a well-controlled investigation shall involve the use of a test device that is standardized in its composition or design and performance.

(g)(1) It is the responsibility of each manufacturer and importer of a device to assure that adequate, valid scientific evidence exists, and to furnish such evidence to the Food and Drug Administration to provide reasonable assurance that the device is safe and effective for its intended uses and conditions of use. The failure of a manufacturer or importer of a device to present to the Food and Drug Administration adequate, valid scientific evidence showing that there is reasonable assurance of the safety and effective-

ness of the device, if regulated by general controls alone, or by general controls and special controls, may support a determination that the device be classified into class III.

(2) The Commissioner may require that a manufacturer, importer, or distributor make reports or provide other information bearing on the classification of a device and indicating whether there is reasonable assurance of the safety and effectiveness of the device or whether it is adulterated or misbranded under the act.

(3) A requirement for a report or other information under this paragraph will comply with section 519 of the act. Accordingly, the requirement will state the reason or purpose for such request; will describe the required report or information as clearly as possible; will not be imposed on a manufacturer, importer, or distributor of a classified device that has been exempted from such a requirement in accordance with § 860.95; will prescribe the time for compliance with the requirement; and will prescribe the form and manner in which the report or information is to be provided.

(4) Required information that has been submitted previously to the Center for Devices and Radiological Health, the Center for Biologics Evaluation and Research, or the Center for Drug Evaluation and Research, as applicable, need not be resubmitted, but may be incorporated by reference.

[43 FR 32993, July 28, 1978, as amended at 53 FR 11253, Apr. 6, 1988; 73 FR 49942, Aug. 25, 2008; 83 FR 64454, Dec. 17, 2018]

### § 860.10 Implants and life-supporting or life-sustaining devices.

(a) A classification panel will recommend classification into class III of any implant or life-supporting or life-sustaining device unless the panel determines that such classification is not necessary to provide reasonable assurance of the safety and effectiveness of the device. If the panel recommends classification or reclassification of such a device into a class other than class III, it shall set forth in its recommendation the reasons for so doing and an identification of the risks to health, if any, presented by the device.

In the case of such a device being recommended for classification or reclassification into class II, the panel shall describe the special controls that, in addition to general controls, the panel believes are necessary to provide reasonable assurance of safety and effectiveness of the device and how such controls provide such assurance.

(b) The Commissioner will classify an implant or life-supporting or life-sustaining device into class III unless the Commissioner determines that such classification is not necessary to provide reasonable assurance of the safety and effectiveness of the device. If the Commissioner proposes to classify or reclassify such a device into a class other than class III, the regulation or order effecting such classification or reclassification will be accompanied by a full statement of the reasons for so doing. A statement of the reasons for not classifying or retaining the device in class III may be in the form of concurrence with the reasons for the recommendation of the classification panel, together with supporting documentation and data satisfying the requirements of §860.7 and an identification of the risks to health, if any, presented by the device. In the case of such a device being classified or reclassified into class II, the Commissioner shall describe the special controls that, in addition to general controls, the panel believes are necessary to provide reasonable assurance of safety and effectiveness of the device and how such controls provide such assurance.

[83 FR 64455, Dec. 17, 2018]

**§ 860.15 Exemptions from sections 510, 519, and 520(f) of the Federal Food, Drug, and Cosmetic Act.**

(a) A panel recommendation to the Commissioner that a device be classified or reclassified into class I will include a recommendation as to whether the device should be exempted from some or all of the requirements of one or more of the following sections of the Federal Food, Drug, and Cosmetic Act: Section 510 (registration, product listing, and premarket notification), section 519 (records and reports) and section 520(f) (good manufacturing practice requirements of the quality system regulation), and, in the case of a

recommendation for classification into class II, whether the device should be exempted from the premarket notification requirement under section 510.

(b) A regulation or an order classifying or reclassifying a device into class I will specify which requirements, if any, of sections 510, 519, and 520(f) of the Federal Food, Drug, and Cosmetic Act the device is to be exempted from or, in the case of a regulation or an order classifying or reclassifying a device into class II, whether the device is to be exempted from the premarket notification requirement under section 510, together with the reasons for such exemption.

(c) The Commissioner will grant exemptions under this section only if the Commissioner determines that the requirements from which the device is exempted are not necessary to provide reasonable assurance of the safety and effectiveness of the device.

[83 FR 64455, Dec. 17, 2018]

**Subpart B—Classification**

**§ 860.84 Classification procedures for “preamendments devices.”**

(a) This subpart sets forth the procedures for the original classification of a generic type of device that was in commercial distribution before May 28, 1976. Such a device will be classified by regulation into either class I (general controls), class II (special controls) or class III (premarket approval), depending upon the level of regulatory control required to provide reasonable assurance of the safety and effectiveness of the device (§860.3(c)). This subpart does not apply to a device that is classified into class III by statute under section 513(f)(1) of the Federal Food, Drug, and Cosmetic Act because the Food and Drug Administration has determined that the device is not “substantially equivalent” to any device subject to this subpart or under section 520(l)(1) of the Federal Food, Drug, and Cosmetic Act because the device was regarded previously as a new drug. In classifying a *preamendments* device to which this section applies, the Food and Drug Administration will follow the procedures described in paragraphs (b) through (g) of this section.

(b) The Commissioner refers the device to the appropriate classification panel organized and operated in accordance with section 513 (b) and (c) of the act and part 14 of this chapter.

(c) In order to make recommendations to the Commissioner on the class of regulatory control (class I, class II, or class III) appropriate for the device, the panel reviews the device for safety and effectiveness. In so doing, the panel:

(1) Considers the factors set forth in § 860.7 relating to the determination of safety and effectiveness;

(2) Determines the safety and effectiveness of the device on the basis of the types of scientific evidence set forth in § 860.7; and

(3) Provides, to the maximum extent practicable, an opportunity for interested persons to submit data and views on the classification of the device in accordance with part 14 of this chapter.

(d) Based upon its review of evidence of the safety and effectiveness of the device, and applying the definition of each class in § 860.3(c), the panel submits to the Commissioner a recommendation regarding the classification of the device. The recommendation will include:

(1) A summary of the reasons for the recommendation;

(2) A summary of the data upon which the recommendation is based;

(3) An identification of the risks to health (if any) presented by the device;

(4) In the case of a recommendation for classification into class I, a recommendation as to whether the device should be exempted from the requirements of one or more of the following sections of the Federal Food, Drug, and Cosmetic Act: Section 510 (registration, product listing, and premarket notification), section 519 (records and reports), and section 520(f) (good manufacturing practice requirements of the quality system regulation) and, in the case of a recommendation for classification into class II, whether the device should be exempted from the premarket notification requirement under section 510, in accordance with § 860.15;

(5) In the case of a recommendation for classification into class II or class III, to the extent practicable, a recommendation for the assignment to

the device of a priority for the application of a performance standard or a premarket approval requirement, and in the case of classification into class II, a recommendation on the establishment of special controls and whether the device should be exempted from premarket notification in accordance with § 860.15; and

(6) In the case of a recommendation for classification of an implant or a life-supporting or life-sustaining device into class I or class II, a statement of why premarket approval is not necessary to provide reasonable assurance of the safety and effectiveness of the device and an identification of the risks to health, if any, presented by the device, in accordance with § 860.10.

(e) A panel recommendation is regarded as preliminary until the Commissioner has reviewed it, discussed it with the panel if appropriate, and published a proposed regulation classifying the device. Preliminary panel recommendations are filed at Dockets Management Staff upon receipt and are available to the public at <https://www.regulations.gov>.

(f) The Commissioner publishes the panel's recommendation in the FEDERAL REGISTER, together with a proposed regulation classifying the device, and other devices of that generic type, and provides interested persons an opportunity to submit comments on the recommendation and proposed regulation.

(g) The Commissioner reviews the comments and issues a final regulation classifying the device and other devices of that generic type. The regulation will:

(1) If classifying the device into class I, prescribe which, if any, of the requirements of sections 510, 519, and 520(f) of the act will not apply to the device and state the reasons for making the requirements inapplicable, in accordance with § 860.95;

(2) If classifying the device into class II, establish the special controls for the device and prescribe whether the premarket notification requirement will apply to the device; and

(3) If classifying an implant, or a life-supporting or life-sustaining device, comply with § 860.10(b).

[43 FR 32993, July 28, 1978, as amended at 57 FR 58404, Dec. 10, 1992; 64 FR 404, Jan. 5, 1999; 83 FR 64455, Dec. 17, 2018]

#### § 860.90 Consultation with panels.

(a) When the Commissioner is required to consult with a panel concerning a classification under § 860.84, the Commissioner will consult with the panel in one of the following ways:

(1) Consultation by telephone with at least a majority of current voting panel members and, when possible, nonvoting panel members in a telephone or video conference call; or

(2) Discussion at a panel meeting.

(b) The method of consultation chosen by the Commissioner will depend upon the importance and complexity of the subject matter involved and the time available for action. When time and circumstances permit, the Commissioner will consult with a panel through discussion at a panel meeting.

[83 FR 64456, Dec. 17, 2018]

### Subpart C—Reclassification

#### § 860.120 General.

(a) Sections 513(e) and (f), 514(b), 515(b), and 520(l) of the act provide for reclassification of a device and prescribe the procedures to be followed to effect reclassification. The purposes of subpart C are to:

(1) Set forth the requirements as to form and content of petitions for reclassification;

(2) Describe the circumstances in which each of the five statutory reclassification provisions applies; and

(3) Explain the procedure for reclassification prescribed in the five statutory reclassification provisions.

(b) The criteria for determining the proper class for a device are set forth in § 860.3(c). The reclassification of any device within a generic type of device causes the reclassification of all devices within that generic type. Accordingly, a petition for the reclassification of a specific device will be considered a petition for reclassification of all devices within the same generic type.

(c) Any interested person may submit a petition for reclassification under section 513(e), 514(b), or 515(b) of the Federal Food, Drug, and Cosmetic Act. A manufacturer or importer may submit a petition for reclassification under section 513(f) or 520(l) of the Federal Food, Drug, and Cosmetic Act. The Commissioner may initiate the reclassification of a device under the following sections of the Federal Food, Drug, and Cosmetic Act:

(1) Section 513(e) (for a classified device other than a device classified into class III under section 513(f)(1) or 520(l)(1) of the Federal Food, Drug, and Cosmetic Act);

(2) Section 513(f)(3) (for a device classified into class III under section 513(f)(1) of the Federal Food, Drug, and Cosmetic Act); or

(3) Section 520(l)(2) (for a device classified into class III under section 520(l)(1) of the Federal Food, Drug, and Cosmetic Act).

[43 FR 32993, July 28, 1978, as amended at 57 FR 58404, Dec. 10, 1992; 83 FR 64456, Dec. 17, 2018]

#### § 860.123 Reclassification petition: Content and form.

(a) Unless otherwise provided in writing by the Commissioner, any petition for reclassification of a device, regardless of the section of the act under which it is filed, shall include the following:

(1) A specification of the type of device for which reclassification is requested;

(2) A statement of the action requested by the petitioner, e.g., "It is requested that \_\_\_ device(s) be reclassified from class III to a class II";

(3) A statement of the basis for disagreement with the present classification status of the device;

(4) A full statement of the reasons, together with supporting data satisfying the requirements of § 860.7, why the device should not be classified into its present classification and how the proposed classification will provide reasonable assurance of the safety and effectiveness of the device;

(5) Representative data and information known by the petitioner that are unfavorable to the petitioner's position;

## § 860.125

## 21 CFR Ch. I (4–1–20 Edition)

(6) If the petition is based upon new information under section 513(e), 514(b), or 515(b) of the act, a summary of the new information;

(7) Copies of source documents from which new information used to support the petition has been obtained (attached as appendices to the petition); and

(8) A financial certification or disclosure statement or both as required by part 54 of this chapter.

(b) Each petition submitted pursuant to this section shall be:

(1) For devices regulated by the Center for Devices and Radiological Health, addressed to the Food and Drug Administration, Center for Devices and Radiological Health, Regulations Staff, Document Mail Center-WO66-G609, 10903 New Hampshire Ave., Silver Spring, MD 20993-0002; for devices regulated by the Center for Biologics Evaluation and Research, addressed to the Food and Drug Administration, Center for Biologics Evaluation and Research, Document Control Center, 10903 New Hampshire Ave., Bldg. 71, Rm. G112, Silver Spring, MD 20993-0002; for devices regulated by the Center for Drug Evaluation and Research, addressed to the Food and Drug Administration, Center for Drug Evaluation and Research, Central Document Control Room, 5901-B Ammendale Rd., Beltsville, MD 20705-1266, as applicable.

(2) Marked clearly with the section of the Federal Food, Drug, and Cosmetic Act under which the petition is being submitted, *i.e.*, “513(e),” “513(f)(3),” “514(b),” “515(b),” or “520(l) Petition”;

(3) Bound in a volume or volumes, where necessary; and

(4) Submitted in an original and two copies.

[43 FR 32993, July 28, 1978, as amended at 49 FR 14505, Apr. 12, 1984; 53 FR 11253, Apr. 6, 1988; 55 FR 11169, Mar. 27, 1990; 63 FR 5254, Feb. 2, 1998; 65 FR 17137, Mar. 31, 2000; 73 FR 49942, Aug. 25, 2008; 75 FR 20916, Apr. 22, 2010; 79 FR 77388, Dec. 24, 2014; 82 FR 39535, Aug. 21, 2017; 83 FR 64456, Dec. 17, 2018]

### § 860.125 Consultation with panels.

(a) When the Commissioner chooses to refer a reclassification petition to a classification panel for its recommendation under § 860.134(b), or the Commissioner is required to consult

with a panel concerning a reclassification petition submitted under § 860.130(d) or received in a proceeding under § 860.133(b), or the Commissioner chooses to consult with a panel with regard to the reclassification of a device initiated by the Commissioner under § 860.134(c) or § 860.136, the Commissioner will distribute a copy of the petition, or its relevant portions, if applicable, to each panel member and will consult with the panel in one of the following ways:

(1) Consultation by telephone with at least a majority of current voting panel members and, when possible, nonvoting panel members in a telephone or video conference call; or

(2) Discussion at a panel meeting.

(b) The method of consultation chosen by the Commissioner will depend upon the importance and complexity of the subject matter involved and the time available for action. When time and circumstances permit, the Commissioner will consult with a panel through discussion at a panel meeting.

(c) The Commissioner will consult with a classification panel prior to changing the classification of a device in a proceeding under section 513(e) of the Federal Food, Drug, and Cosmetic Act and § 860.130 upon the Commissioner's own initiative or upon petition of an interested person, and in the latter case, the Commissioner will distribute a copy of the petition, or its relevant portions, to each panel member.

(d) When a petition is submitted under § 860.134 for a postamendments, not substantially equivalent, device, if the Commissioner chooses to consult with the panel, the Commissioner will obtain a recommendation that includes the information described in § 860.84(d). In consulting with a panel about a petition submitted under § 860.130(d), § 860.136(a), or received in a proceeding under § 860.133(b), the Commissioner may or may not obtain a formal recommendation.

[43 FR 32993, July 28, 1978, as amended at 83 FR 64456, Dec. 17, 2018]

**§ 860.130 General procedures under section 513(e) of the Federal Food, Drug, and Cosmetic Act.**

(a) Section 513(e) of the act applies to reclassification proceedings under the act based upon new information.

(b) A proceeding to reclassify a device under section 513(e) may be initiated:

(1) On the initiative of the Commissioner alone;

(2) On the initiative of the Commissioner in response to a request for change in classification based upon new information, under section 514(b) or 515(b) of the act (see § 860.132); or

(3) In response to the petition of an interested person, based upon new information, filed in accordance with § 860.123.

(c) By administrative order published under this section, the Commissioner may change the classification from:

(1) Class I or class II to class III if the Commissioner determines that the device meets the criteria set forth in § 860.3(c)(3) for a class III device; or

(2) Class III or class I to class II if the Commissioner determines that the device meets the criteria set forth in § 860.3(c)(2) for a class II device; or

(3) Class III or class II to class I if the Commissioner determines that the device meets the criteria set forth in § 860.3(c)(1) for a class I device.

(d)(1) The Commissioner shall consult with a classification panel and may secure a recommendation with respect to reclassification of a device from a classification panel. The panel will consider reclassification in accordance with the consultation procedures of § 860.125. A recommendation submitted to the Commissioner by the panel will be published in the FEDERAL REGISTER when the Commissioner publishes an administrative order under this section.

(2) The Commissioner may change the classification of a device by administrative order published in the FEDERAL REGISTER following publication of a proposed reclassification order in the FEDERAL REGISTER, a meeting of a device classification panel described in section 513(b) of the Federal Food, Drug, and Cosmetic Act, and consideration of comments to a public docket.

(e) Within 180 days after the filing of a petition for reclassification under this section, the Commissioner will either deny the petition by order published in the FEDERAL REGISTER or give notice of the intent to initiate a change in the classification of the device.

(f) If a device is reclassified under this section, the administrative order effecting the reclassification may revoke any special control or premarket approval requirement that previously applied to the device but that is no longer applicable because of the change in classification.

(g) An administrative order under this section changing the classification of a device to class II may provide that such reclassification will not take effect until the effective date of a performance standard for the device established under section 514 of the Federal Food, Drug, and Cosmetic Act or other special controls established under the order. An order under this section changing the classification of a device to class II may also establish the special controls necessary to provide reasonable assurance of the safety and effectiveness of the device.

[43 FR 32993, July 28, 1978, as amended at 57 FR 58404, Dec. 10, 1992; 83 FR 64456, Dec. 17, 2018]

**§ 860.132 Procedures when the Commissioner initiates a performance standard or premarket approval proceeding under section 514(b) or 515(b) of the Federal Food, Drug, and Cosmetic Act.**

(a) Sections 514(b) and 515(b) of the Federal Food, Drug, and Cosmetic Act require the Commissioner to provide, by notice in the FEDERAL REGISTER, an opportunity for interested parties to petition to change the classification of a device based upon new information relevant to its classification when the Commissioner initiates a proceeding to develop a performance standard for the device if in class II or to issue an order requiring premarket approval for the device if in class III.

(b) If the Commissioner agrees that the new information submitted in response to a proposed order to require premarket approval of a device issued under section 515(b) of the Federal

### § 860.133

Food, Drug, and Cosmetic Act warrants a change in classification, the Commissioner shall follow the administrative order procedures under section 513(e) of the Federal Food, Drug, and Cosmetic Act and § 860.130 to effect such a change.

(c) If the Commissioner does not agree that the new information submitted in response to a proposed order to require premarket approval of a device issued under section 515(b) of the Federal Food, Drug, and Cosmetic Act warrants a change in classification, the Commissioner will deny the petition.

(d) The procedures under section 514(b) of the Federal Food, Drug, and Cosmetic Act are as follows:

(1) Within 30 days after publication of the Commissioner's notice referred to in paragraph (a) of this section, an interested person files a petition for reclassification in accordance with § 860.123.

(2) The Commissioner consults with the appropriate classification panel with regard to the petition in accordance with § 860.125.

(3) Within 60 days after publication of the notice referred to in paragraph (a) of this section, the Commissioner either denies the petition or gives notice of the intent to initiate a change in classification in accordance with § 860.130.

[43 FR 32993, July 28, 1978, as amended at 83 FR 64457, Dec. 17, 2018]

### **§ 860.133 Procedures when the Commissioner initiates a proceeding to require premarket approval under section 515(b) of the Federal Food, Drug, and Cosmetic Act.**

(a) Section 515(b) of the Federal Food, Drug, and Cosmetic Act applies to proceedings to require premarket approval for a class III preamendments device.

(b) The Commissioner may require premarket approval for a class III preamendments device by administrative order published in the FEDERAL REGISTER following publication of a proposed order in the FEDERAL REGISTER, a meeting of a device classification panel described in section 513(b) of the Federal Food, Drug, and Cosmetic Act, and consideration of comments from all affected stakeholders, includ-

### 21 CFR Ch. I (4–1–20 Edition)

ing patients, payors, and providers. The panel will consider reclassification petitions received in the proceeding in accordance with section 513(e) of the Federal Food, Drug, and Cosmetic Act and the applicable consultation procedures in § 860.125. A recommendation submitted to the Commissioner by the panel will be published in the FEDERAL REGISTER when the Commissioner publishes an administrative order under this section.

[83 FR 64457, Dec. 17, 2018]

### **§ 860.134 Procedures for reclassification of “postamendments devices” under section 513(f)(3) of the Federal Food, Drug, and Cosmetic Act.**

(a) Section 513(f)(3) of the act applies to proceedings for reclassification of a device currently in class III by operation of section 513(f)(1) of the act. This category includes any device that is to be first introduced or delivered for introduction into interstate commerce for commercial distribution after May 28, 1976, unless:

(1) It is substantially equivalent to another device that was in commercial distribution before that date and had not been regulated before that date as a new drug; or

(2) It is substantially equivalent to another device that was not in commercial distribution before such date but which has been classified into class I or class II; or

(3) The Commissioner has classified the device into class I or class II in response to a petition for reclassification under this section; or

(4) The device is classified under a request for De Novo classification under section 513(f)(2) of the Federal Food, Drug, and Cosmetic Act.

(b) The procedures for effecting reclassification under section 513(f)(3) of the Federal Food, Drug, and Cosmetic Act when initiated by a manufacturer or importer are as follows:

(1) The manufacturer or importer of the device petitions for reclassification of the device in accordance with § 860.123.

(2) Within 30 days after the petition is filed, the Commissioner notifies the petitioner of any deficiencies in the petition that prevent the Commissioner



from making a decision on it and allows the petitioner to supplement a deficient petition. Within 30 days after any supplemental material is received, the Commissioner notifies the petitioner whether the petition, as supplemented, is adequate for review.

(3) After determining that the petition contains no deficiencies precluding a decision on it, the Commissioner may for good cause shown refer the petition to the appropriate classification panel for its review and recommendation whether to approve or deny the petition.

(4) Within 90 days after the date the petition is referred to the panel, following the review procedures set forth in §860.84(c) for the original classification of a “preamendments device”, the panel submits to the Commissioner its recommendation containing the information set forth in §860.84(d). A panel recommendation is regarded as preliminary until the Commissioner has reviewed it, discussed it with the panel, if appropriate, and developed a proposed reclassification order. Preliminary panel recommendations are filed at Dockets Management Staff upon receipt and are available to the public and posted at <https://www.regulations.gov>.

(5) The panel recommendation is published in the FEDERAL REGISTER as soon as practicable and interested persons are provided an opportunity to comment on the recommendation.

(6) Within 90 days after the panel’s recommendation is received (and no more than 210 days after the date the petition was filed), the Commissioner denies or approves the petition by order in the form of a letter to the petitioner. If the Commissioner approves the petition, the order will classify the device into class I or class II in accordance with the criteria set forth in §860.3(c) and subject to the applicable requirements of §860.10, relating to the classification of implants and life-supporting or life-sustaining devices, and §860.15, relating to exemptions from certain requirements of the Federal Food, Drug, and Cosmetic Act.

(7) Within a reasonable time after issuance of an order under this section, the Commissioner announces the order

by notice published in the FEDERAL REGISTER.

(c) By administrative order published under section 513(f)(3) of the Federal Food, Drug, and Cosmetic Act, the Commissioner may, on the Commissioner’s own initiative, change the classification from class III under section 513(f)(1) either to class II, if the Commissioner determines that special controls in addition to general controls are necessary and sufficient to provide reasonable assurance of the safety and effectiveness of the device and there is sufficient information to establish special controls to provide such assurance, or to class I if the Commissioner determines that general controls alone would provide reasonable assurance of the safety and effectiveness of the device. The procedures for the reclassification proceeding under this paragraph (c) are as follows:

(1) The Commissioner publishes a proposed reclassification order in the FEDERAL REGISTER seeking comment on the proposed reclassification.

(2) The Commissioner may consult with the appropriate classification panel with respect to the reclassification of the device. The panel will consider reclassification in accordance with the consultation procedures of §860.125.

(3) Following consideration of comments to a public docket and any panel recommendations or comments, the Commissioner may change the classification of a device by final administrative order published in the FEDERAL REGISTER.

(d) An administrative order under this section changing the classification of a device from class III to class II may establish the special controls necessary to provide reasonable assurance of the safety and effectiveness of the device.

[43 FR 32993, July 28, 1978, as amended at 57 FR 58404, Dec. 10, 1992; 73 FR 34860, June 19, 2008; 83 FR 64457, Dec. 17, 2018]

**§860.136 Procedures for transitional products under section 520(l) of the Federal Food, Drug, and Cosmetic Act.**

(a) Section 520(l)(2) of the Federal Food, Drug, and Cosmetic Act applies

to reclassification proceedings initiated by the Commissioner or in response to a request by a manufacturer or importer for reclassification of a device currently in class III by operation of section 520(l)(1). This section applies only to devices that the Food and Drug Administration regarded as “new drugs” before May 28, 1976.

(b) The procedures for effecting reclassification under section 520(l) of the Federal Food, Drug, and Cosmetic Act when initiated by a manufacturer or importer are as follows:

(1) The manufacturer or importer of the device files a petition for reclassification of the device in accordance with §860.123.

(2) Within 30 days after the petition is filed, the Commissioner notifies the petitioner of any deficiencies in the petition that prevent the Commissioner from making a decision on it, allowing the petitioner to supplement a deficient petition. Within 30 days after any supplemental material is received, the Commissioner notifies the petitioner whether the petition, as supplemented, is adequate for review.

(3) The Commissioner consults with the appropriate classification panel with regard to the petition in accordance with §860.125.

(4) Within 180 days after the petition is filed (where the Commissioner has determined it to be adequate for review), the Commissioner, by order in the form of a letter to the petitioner, either denies the petition or classifies the device into class I or class II in accordance with the criteria set forth in §860.3(c).

(5) Within a reasonable time after issuance of an order under this section, the Commissioner announces the order by notice published in the FEDERAL REGISTER.

(c) By administrative order, the Commissioner may, on the Commissioner’s own initiative, change the classification from class III under section 520(l) of the Federal Food, Drug, and Cosmetic Act either to class II, if the Commissioner determines that special controls in addition to general controls are necessary and sufficient to provide reasonable assurance of the safety and effectiveness of the device and there is sufficient information to establish spe-

cial controls to provide such assurance, or to class I if the Commissioner determines that general controls alone would provide reasonable assurance of the safety and effectiveness of the device. The procedures for the reclassification proceeding under this paragraph (c) are as follows:

(1) The Commissioner publishes a proposed reclassification order in the FEDERAL REGISTER seeking comment on the proposed reclassification.

(2) The Commissioner may consult with the appropriate classification panel with respect to the reclassification of the device. The panel will consider reclassification in accordance with the consultation procedures of §860.125.

(3) Following consideration of comments to a public docket and any panel recommendations or comments, the Commissioner may change the classification of a device by final administrative order published in the FEDERAL REGISTER.

(d) An administrative order under this section changing the classification of a device from class III to class II may establish the special controls necessary to provide reasonable assurance of the safety and effectiveness of the device.

[43 FR 32993, July 28, 1978, as amended at 83 FR 64458, Dec. 17, 2018]

## PART 861—PROCEDURES FOR PERFORMANCE STANDARDS DEVELOPMENT

### Subpart A—General

- Sec.  
861.1 Purpose and scope.  
861.5 Statement of policy.  
861.7 Contents of standards.

### Subpart B—Procedures for Performance Standards Development and Publication

- 861.20 Summary of standards development process.  
861.24 Existing standard as a proposed standard.  
861.30 Development of standards.  
861.34 Amendment or revocation of a standard.  
861.36 Effective dates.  
861.38 Standards advisory committees.

AUTHORITY: 21 U.S.C. 351, 352, 360c, 360d, 360gg–360ss, 371, 374; 42 U.S.C. 262, 264.

SOURCE: 45 FR 7484, Feb. 1, 1980, unless otherwise noted.

### Subpart A—General

#### § 861.1 Purpose and scope.

(a) This part implements section 514 of the Federal Food, Drug, and Cosmetic Act (the act) with respect to the establishment, amendment, and revocation of performance standards applicable to devices intended for human use.

(b) The Food and Drug Administration may determine that a performance standard, as described under special controls for class II devices in § 860.7(b) of this chapter, is necessary to provide reasonable assurance of the safety and effectiveness of the device. Performance standards may be established for:

- (1) A class II device;
- (2) A class III device which, upon the effective date of the standard, is reclassified into class II; and
- (3) A class III device, as a condition to premarket approval under section 515 of the act, to reduce or eliminate a risk or risks associated with such device.

(c) References in this part to regulatory sections of the Code of Federal Regulations are to chapter I of title 21 unless otherwise noted.

[45 FR 7484, Feb. 1, 1980, as amended at 45 FR 23686, Apr. 8, 1980; 57 FR 58404, Dec. 10, 1992]

#### § 861.5 Statement of policy.

In carrying out its duties under this section, the Food and Drug Administration will, to the maximum extent practical:

- (a) Use personnel, facilities, and other technical support available in other Federal agencies;
- (b) Consult with other Federal agencies concerned with standard setting and other nationally or internationally recognized standard-setting entities; and
- (c) Invite participation, through conferences, workshops, or other means, by representatives of scientific, professional, industry, or consumer organizations who can make a significant contribution.

#### § 861.7 Contents of standards.

Any performance standard established under this part will include such provisions as the Food and Drug Administration determines are necessary to provide reasonable assurance of the safety and effectiveness of the device or devices for which it is established. Where necessary to provide such assurance, a standard will address (but need not be limited to):

(a) Performance characteristics of the device;

(b) The design, construction, components, ingredients, and properties of the device, and its compatibility with power systems and connections to such systems;

(c) The manufacturing processes and quality control procedures applicable to the device;

(d) Testing of the device on either a sample or a 100-percent basis by the manufacturer, or, if it is determined that no other more practical means are available to the Food and Drug Administration to assure the conformity of the device to the standard, providing for testing by the Food and Drug Administration or a third person to ensure that the device conforms to the standard;

(e) The publication of the results of each test or of certain tests of the device to show that the device conforms to the portions of the standard for which the test or tests were required;

(f) Manufacturers' certification to purchasers or to the Food and Drug Administration that the device conforms to the applicable performance standard;

(g) Restrictions on the sale and distribution of the device, but only to the extent authorized under section 520(e) of the act;

(h) The use, and the form and content, of labeling for the proper installation, maintenance, operation, and use of the device. Among the provisions that may be required in the labeling are warnings; storage and transportation information; expiration dates; the date and place of manufacture; the results that may be expected if the device is used properly; the ranges of accuracy of diagnostic information; instructions regarding the proper care of,

## § 861.20

## 21 CFR Ch. I (4–1–20 Edition)

and the proper components, accessories, or other equipment to be used with the device; and statements concerning the appropriate patient population, for example, a statement that the device is considered safe and effective only when used by, or in the treatment of, a patient who has been tested by particular designated procedures and found to have an illness or condition for which use of the device is indicated by a person skilled in the use of the device.

### Subpart B—Procedures for Performance Standards Development and Publication

#### § 861.20 Summary of standards development process.

The procedure by which a performance standard for a device may be established, amended, or revoked is as follows:

(a) The Food and Drug Administration (FDA) will publish in the FEDERAL REGISTER a notice of proposed rulemaking for the establishment, amendment, or revocation of any performance standard for a device.

(1) A notice of proposed rulemaking for the establishment or amendment of a performance standard for a device will:

(i) Set forth a finding, with supporting justification, that the performance standard is appropriate and necessary to provide reasonable assurance of the safety and effectiveness of the device;

(ii) Set forth proposed findings with respect to the risk of illness or injury that the performance standard is intended to reduce or eliminate;

(iii) Invite interested persons to submit to the Food and Drug Administration, within 30 days of the publication of the notice, requests for changes in the classification of the device pursuant to § 860.132 of this chapter, based on new information relevant to the classification; and

(iv) Invite interested persons to submit an existing performance standard for the device, including a draft or proposed performance standard, for consideration by the Commissioner of Food and Drugs.

(2) A notice of proposed rulemaking for the revocation of a performance standard will set forth a finding, with supporting justification, that the performance standard is no longer necessary to provide reasonable assurance of the safety and effectiveness of a device.

(b) A notice under this section will provide for a comment period of not less than 60 days.

(c) If, after publication of a notice under paragraph (a) of this section, FDA receives a request to change the classification of the device, FDA will, within 60 days of the publication of the notice and after consultation with the appropriate panel under § 860.125 of this chapter, either deny the request or give notice of its intent to initiate a change in the classification under § 860.130.

(d) If FDA initiates a rulemaking proceeding under paragraph (a) of this section, FDA will:

(1) Complete the proceeding and establish the performance standard for the device in accordance with this part and § 10.40 of this chapter; or

(2) Terminate the proceeding by publishing in the FEDERAL REGISTER a notice announcing such termination and the reasons therefor and, unless the proceeding is terminated because the device is a banned device, initiate a proceeding in accordance with section 513(e) of the act to reclassify the device; or

(3) Take other appropriate action.

[57 FR 58404, Dec. 10, 1992]

#### § 861.24 Existing standard as a proposed standard.

(a) The Food and Drug Administration may accept an existing standard or a proposed or draft standard if it includes:

(1) A description of the procedures used to develop the standard and a list of the persons and organizations that participated in its development, to the extent that such information is available or reasonably obtainable;

(2) An identification of the specific portions of the existing standard that the person submitting the standard believes are appropriate for adoption as, or inclusion in, the proposed standard; and

(3) A summary of the test data, or, if requested by the Food and Drug Administration, all such data or other information supporting the specific portions of the standard identified by the person submitting the standard.

(b) The Food and Drug Administration will publish a notice in the FEDERAL REGISTER stating either that it has accepted, or accepted with modification, as a proposed standard, an existing standard or one that has been developed, or that an existing standard is not acceptable, together with the reasons therefor.

[45 FR 7484, Feb. 1, 1980, as amended at 57 FR 58405, Dec. 10, 1992]

#### § 861.30 Development of standards.

The Food and Drug Administration (FDA), while engaged in the development of a proposed standard under this section will:

(a) Support its proposed performance standard by such test data or other documents or materials as may reasonably be required;

(b) Provide interested persons an opportunity to participate in the development of the standard by accepting comments and, where appropriate, holding public meetings on issues relating to development of the standard. Notice of the opportunity to participate in the development of the standard will be furnished in a manner reasonably calculated to reach the majority of persons interested in the development of the standard. This requirement shall be satisfied by publishing such a notice in the FEDERAL REGISTER. Whenever it is appropriate, FDA will use the FEDERAL REGISTER to make announcements about the standard development process of standard developers other than Federal agencies.

(c) Maintain records disclosing the course of development of the proposed standard, the comments and other information submitted by a person in connection with such development (including comments and information regarding the need for a standard), and such other information as may be required to evaluate the standard.

[45 FR 7484, Feb. 1, 1980, as amended at 57 FR 58405, Dec. 10, 1992]

#### § 861.34 Amendment or revocation of a standard.

(a) The Food and Drug Administration will provide for periodic evaluation of performance standards to determine whether such standards should be changed to reflect new medical, scientific, or other technological data.

(b) The Food and Drug Administration may, on its own initiative or upon petition of an interested party, amend or revoke by regulation a standard established under this part.

(c) Any petition to amend or revoke a standard shall:

(1) Identify the specific device and standard for which the amendment or revocation is sought; and

(2) Be submitted in accordance with the requirements of § 10.30.

(d) Proceedings to amend or revoke a performance standard shall be conducted in accordance with the rulemaking procedures of § 10.40. In addition, a notice of proposed rulemaking to amend or revoke a standard shall set forth proposed findings with respect to the degree of risk or illness to be eliminated or reduced and the benefit the public will derive from the proposed amendment or revocation.

#### § 861.36 Effective dates.

(a) A regulation establishing, amending, or revoking a performance standard will set forth the date upon which it will take effect. To the extent practical, consistent with the public health and safety, such effective date will be established so as to minimize economic loss to, and disruption or dislocation of, domestic and international trade.

(b) Except as provided in paragraph (c) of this section, no regulation establishing, amending, or revoking a standard may take effect before 1 year after the date of its publication unless:

(1) The Food and Drug Administration determines that an earlier effective date is necessary to protect the public health and safety; or

(2) The standard has been established for a device that, by the effective date of the standard, has been reclassified from class III to class II.

(c) The Food and Drug Administration may declare a proposed regulation amending a standard effective on publication in the FEDERAL REGISTER if it

## § 861.38

determines that making the regulation so effective is in the public interest. A proposed amendment of a performance standard made effective upon publication may not prohibit the introduction or delivery for introduction into interstate commerce of a device that conforms to the standard without the change or changes provided in the proposed amendment until the effective date of any final action on the proposal.

[45 FR 7484, Feb. 1, 1980, as amended at 57 FR 58405, Dec. 10, 1992]

### § 861.38 Standards advisory committees.

(a) The Food and Drug Administration will establish advisory committees to which proposed regulations may be referred, and these committees shall consider such referrals in accordance with this section and part 14 of this chapter. Such advisory committees, which may not be classification panels, shall be considered ad hoc advisory committees. Their members shall be selected in accordance with §§ 14.82 and 14.84, except that no member may be a regular full-time FDA employee. Each advisory committee established under this section shall include as nonvoting members a representative of consumer interests and a representative of interests of the device manufacturing industry.

(b) A proposed regulation to establish, amend, or revoke a performance standard shall be referred to an advisory committee for a report and recommendation with respect to any matter involved in the proposed regulation which requires the exercise of scientific judgment if:

(1) The Food and Drug Administration determines that such referral is necessary or appropriate under the circumstances; or

(2) Requested by an interested person, in the form of a citizen petition in accordance with § 10.30 of this chapter, which is made within the period provided for comment on the proposed regulation and which demonstrates good cause for referral.

(c) When a proposed regulation is referred to an advisory committee, the Food and Drug Administration will furnish the committee with the data and

## 21 CFR Ch. I (4–1–20 Edition)

information upon which the proposed regulation is based. After independently reviewing the materials furnished by the Food and Drug Administration and any other available data and information, the advisory committee shall, within 60 days of the referral, submit a report and recommendation on the proposed regulation, together with all underlying data and information and a statement of the reason or basis for the recommendation. A copy of the report and recommendation will be publicly displayed in the office of the Division of Dockets Management, Food and Drug Administration.

(d) Where appropriate, each proposed regulation establishing a standard published in the FEDERAL REGISTER will include a call for nominations to the advisory committee for that particular standard.

[45 FR 7484, Feb. 1, 1980, as amended at 57 FR 58405, Dec. 10, 1992]

## PART 862—CLINICAL CHEMISTRY AND CLINICAL TOXICOLOGY DEVICES

### Subpart A—General Provisions

Sec.

- 862.1 Scope.
- 862.2 Regulation of calibrators.
- 862.3 Effective dates of requirement for pre-market approval.
- 862.9 Limitations of exemptions from section 510(k) of the Federal Food, Drug, and Cosmetic Act (the act).

### Subpart B—Clinical Chemistry Test Systems

- 862.1020 Acid phosphatase (total or prostatic) test system.
- 862.1025 Adrenocorticotrophic hormone (ACTH) test system.
- 862.1030 Alanine amino transferase (ALT/SGPT) test system.
- 862.1035 Albumin test system.
- 862.1040 Aldolase test system.
- 862.1045 Aldosterone test system.
- 862.1050 Alkaline phosphatase or isoenzymes test system.
- 862.1055 Newborn screening test system for amino acids, free carnitine, and acylcarnitines using tandem mass spectrometry.
- 862.1060 Delta-aminolevulinic acid test system.
- 862.1065 Ammonia test system.
- 862.1070 Amylase test system.
- 862.1075 Androstenedione test system.

- 862.1080 Androsterone test system.
- 862.1085 Angiotensin I and renin test system.
- 862.1090 Angiotensin converting enzyme (A.C.E.) test system.
- 862.1095 Ascorbic acid test system.
- 862.1100 Aspartate amino transferase (AST/SGOT) test system.
- 862.1110 Bilirubin (total or direct) test system.
- 862.1113 Bilirubin (total and unbound) in the neonate test system.
- 862.1115 Urinary bilirubin and its conjugates (nonquantitative) test system.
- 862.1117 B-type natriuretic peptide test system.
- 862.1118 Biotinidase test system.
- 862.1120 Blood gases (P<sub>CO2</sub>P<sub>O2</sub>) and blood pH test system.
- 862.1130 Blood volume test system.
- 862.1135 C-peptides of proinsulin test system.
- 862.1140 Calcitonin test system.
- 862.1145 Calcium test system.
- 862.1150 Calibrator.
- 862.1155 Human chorionic gonadotropin (HCG) test system.
- 862.1160 Bicarbonate/carbon dioxide test system.
- 862.1163 Cardiac allograft gene expression profiling test system.
- 862.1165 Catecholamines (total) test system.
- 862.1170 Chloride test system.
- 862.1175 Cholesterol (total) test system.
- 862.1177 Cholyglycine test system.
- 862.1180 Chymotrypsin test system.
- 862.1185 Compound S (11-deoxycortisol) test system.
- 862.1187 Conjugated sulfolithocholic acid (SLCG) test system.
- 862.1190 Copper test system.
- 862.1195 Corticoids test system.
- 862.1200 Corticosterone test system.
- 862.1205 Cortisol (hydrocortisone and hydroxycorticosterone) test system.
- 862.1210 Creatine test system.
- 862.1215 Creatine phosphokinase/creatin kinase or isoenzymes test system.
- 862.1220 Acute kidney injury test system.
- 862.1225 Creatinine test system.
- 862.1230 Cyclic AMP test system.
- 862.1235 Cyclosporine test system.
- 862.1240 Cystine test system.
- 862.1245 Dehydroepiandrosterone (free and sulfate) test system.
- 862.1250 Desoxycorticosterone test system.
- 862.1255 2,3-Diphosphoglyceric acid test system.
- 862.1260 Estradiol test system.
- 862.1265 Estriol test system.
- 862.1270 Estrogens (total, in pregnancy) test system.
- 862.1275 Estrogens (total, nonpregnancy) test system.
- 862.1280 Estrone test system.
- 862.1285 Etiocholanolone test system.
- 862.1290 Fatty acids test system.
- 862.1295 Folic acid test system.
- 862.1300 Follicle-stimulating hormone test system.
- 862.1305 Formiminoglutamic acid (FIGLU) test system.
- 862.1310 Galactose test system.
- 862.1315 Galactose-1-phosphate uridyl transferase test system.
- 862.1320 Gastric acidity test system.
- 862.1325 Gastrin test system.
- 862.1330 Globulin test system.
- 862.1335 Glucagon test system.
- 862.1340 Urinary glucose (nonquantitative) test system.
- 862.1345 Glucose test system.
- 862.1350 Continuous glucose monitor secondary display.
- 862.1358 Insulin therapy adjustment device.
- 862.1360 Gamma-glutamyl transpeptidase and isoenzymes test system.
- 862.1365 Glutathione test system.
- 862.1370 Human growth hormone test system.
- 862.1373 Hemoglobin A1c test system.
- 862.1375 Histidine test system.
- 862.1377 Urinary homocystine (nonquantitative) test system.
- 862.1380 Hydroxybutyric dehydrogenase test system.
- 862.1385 17-Hydroxycorticosteroids (17-ketogenic steroids) test system.
- 862.1390 5-Hydroxyindole acetic acid/serotonin test system.
- 862.1395 17-Hydroxyprogesterone test system.
- 862.1400 Hydroxyproline test system.
- 862.1405 Immunoreactive insulin test system.
- 862.1410 Iron (non-heme) test system.
- 862.1415 Iron-binding capacity test system.
- 862.1420 Isocitric dehydrogenase test system.
- 862.1430 17-Ketosteroids test system.
- 862.1435 Ketones (nonquantitative) test system.
- 862.1440 Lactate dehydrogenase test system.
- 862.1445 Lactate dehydrogenase isoenzymes test system.
- 862.1450 Lactic acid test system.
- 862.1455 Lecithin/sphingomyelin ratio in amniotic fluid test system.
- 862.1460 Leucine aminopeptidase test system.
- 862.1465 Lipase test system.
- 862.1470 Lipid (total) test system.
- 862.1475 Lipoprotein test system.
- 862.1485 Luteinizing hormone test system.
- 862.1490 Lysozyme (muramidase) test system.
- 862.1495 Magnesium test system.
- 862.1500 Malic dehydrogenase test system.
- 862.1505 Mucopolysaccharides (nonquantitative) test system.
- 862.1509 Methylmalonic acid (nonquantitative) test system.
- 862.1510 Nitrite (nonquantitative) test system.

862.1515 Nitrogen (amino-nitrogen) test system.

862.1520 5'-Nucleotidase test system.

862.1530 Plasma oncometry test system.

862.1535 Ornithine carbamyl transferase test system.

862.1540 Osmolality test system.

862.1542 Oxalate test system.

862.1545 Parathyroid hormone test system.

862.1550 Urinary pH (nonquantitative) test system.

862.1555 Phenylalanine test system.

862.1560 Urinary phenylketones (non-quantitative) test system.

862.1565 6-Phosphogluconate dehydrogenase test system.

862.1570 Phosphohexose isomerase test system.

862.1575 Phospholipid test system.

862.1580 Phosphorus (inorganic) test system.

862.1585 Human placental lactogen test system.

862.1590 Porphobilinogen test system.

862.1595 Porphyrins test system.

862.1600 Potassium test system.

862.1605 Pregnanediol test system.

862.1610 Pregnanetriol test system.

862.1615 Pregnenolone test system.

862.1620 Progesterone test system.

862.1625 Prolactin (lactogen) test system.

862.1630 Protein (fractionation) test system.

862.1635 Total protein test system.

862.1640 Protein-bound iodine test system.

862.1645 Urinary protein or albumin (non-quantitative) test system.

862.1650 Pyruvate kinase test system.

862.1655 Pyruvic acid test system.

862.1660 Quality control material (assayed and unassayed).

862.1665 Sodium test system.

862.1670 Sorbitol dehydrogenase test system.

862.1675 Blood specimen collection device.

862.1678 Tacrolimus test system.

862.1680 Testosterone test system.

862.1685 Thyroxine-binding globulin test system.

862.1690 Thyroid-stimulating hormone test system.

862.1695 Free thyroxine test system.

862.1700 Total thyroxine test system.

862.1705 Triglyceride test system.

862.1710 Total triiodothyronine test system.

862.1715 Triiodothyronine uptake test system.

862.1720 Triose phosphate isomerase test system.

862.1725 Trypsin test system.

862.1730 Free tyrosine test system.

862.1770 Urea nitrogen test system.

862.1775 Uric acid test system.

862.1780 Urinary calculi (stones) test system.

862.1785 Urinary urobilinogen (nonquantitative) test system.

862.1790 Uroporphyrin test system.

862.1795 Vanilmandelic acid test system.

862.1805 Vitamin A test system.

862.1810 Vitamin B<sub>12</sub> test system.

862.1815 Vitamin E test system.

862.1820 Xylose test system.

862.1825 Vitamin D test system.

862.1840 Total 25-hydroxyvitamin D mass spectrometry test system.

### Subpart C—Clinical Laboratory Instruments

862.2050 General purpose laboratory equipment labeled or promoted for a specific medical use.

862.2100 Calculator/data processing module for clinical use.

862.2120 Continuous glucose monitor data management system.

862.2140 Centrifugal chemistry analyzer for clinical use.

862.2150 Continuous flow sequential multiple chemistry analyzer for clinical use.

862.2160 Discrete photometric chemistry analyzer for clinical use.

862.2170 Micro chemistry analyzer for clinical use.

862.2230 Chromatographic separation material for clinical use.

862.2250 Gas liquid chromatography system for clinical use.

862.2260 High pressure liquid chromatography system for clinical use.

862.2265 High throughput genomic sequence analyzer for clinical use.

862.2270 Thin-layer chromatography system for clinical use.

862.2300 Colorimeter, photometer, or spectrophotometer for clinical use.

862.2310 Clinical sample concentrator.

862.2320 Beta or gamma counter for clinical use.

862.2400 Densitometer/scanner (integrating, reflectance, TLC, or radiochromatogram) for clinical use.

862.2485 Electrophoresis apparatus for clinical use.

862.2500 Enzyme analyzer for clinical use.

862.2540 Flame emission photometer for clinical use.

862.2560 Fluorometer for clinical use.

862.2570 Instrumentation for clinical multiplex test systems.

862.2680 Microtitrator for clinical use.

862.2700 Nephelometer for clinical use.

862.2720 Plasma oncometer for clinical use.

862.2730 Osmometer for clinical use.

862.2750 Pipetting and diluting system for clinical use.

862.2800 Refractometer for clinical use.

862.2850 Atomic absorption spectrophotometer for clinical use.

862.2860 Mass spectrometer for clinical use.

862.2900 Automated urinalysis system.

862.2920 Plasma viscometer for clinical use.

### Subpart D—Clinical Toxicology Test Systems

862.3030 Acetaminophen test system.



862.3035	Amikacin test system.
862.3040	Alcohol test system.
862.3050	Breath-alcohol test system.
862.3080	Breath nitric oxide test system.
862.3100	Amphetamine test system.
862.3110	Antimony test system.
862.3120	Arsenic test system.
862.3150	Barbiturate test system.
862.3170	Benzodiazepine test system.
862.3200	Clinical toxicology calibrator.
862.3220	Carbon monoxide test system.
862.3240	Cholinesterase test system.
862.3250	Cocaine and cocaine metabolite test system.
862.3270	Codeine test system.
862.3280	Clinical toxicology control material.
862.3300	Digitoxin test system.
862.3320	Digoxin test system.
862.3350	Diphenylhydantoin test system.
862.3360	Drug metabolizing enzyme genotyping system.
862.3380	Ethosuximide test system.
862.3450	Gentamicin test system.
862.3520	Kanamycin test system.
862.3550	Lead test system.
862.3555	Lidocaine test system.
862.3560	Lithium test system.
862.3580	Lysergic acid diethylamide (LSD) test system.
862.3590	Meprobamate test system.
862.3600	Mercury test system.
862.3610	Methamphetamine test system.
862.3620	Methadone test system.
862.3630	Methaqualone test system.
862.3640	Morphine test system.
862.3645	Neuroleptic drugs radioreceptor assay test system.
862.3650	Opiate test system.
862.3652	Organophosphate test system.
862.3660	Phenobarbital test system.
862.3670	Phenothiazine test system.
862.3680	Primidone test system.
862.3700	Propoxyphene test system.
862.3750	Quinine test system.
862.3800	Reagents for molecular diagnostic instrument test systems.
862.3830	Salicylate test system.
862.3840	Sirolimus test system.
862.3850	Sulfonamide test system.
862.3870	Cannabinoid test system.
862.3880	Theophylline test system.
862.3900	Tobramycin test system.
862.3910	Tricyclic antidepressant drugs test system.
862.3950	Vancomycin test system.

AUTHORITY: 21 U.S.C. 351, 360, 360c, 360e, 360j, 360l, 371.

SOURCE: 52 FR 16122, May 1, 1987, unless otherwise noted.

EDITORIAL NOTE: Nomenclature changes to part 862 appear at 73 FR 35341, June 23, 2008.

## Subpart A—General Provisions

### § 862.1 Scope.

(a) This part sets forth the classification of clinical chemistry and clinical toxicology devices intended for human use that are in commercial distribution.

(b) The identification of a device in a regulation in this part is not a precise description of every device that is, or will be, subject to the regulation. A manufacturer who submits a pre-market notification submission for a device under part 807 cannot show merely that the device is accurately described by the section title and identification provisions of a regulation in this part, but shall state why the device is substantially equivalent to other devices, as required in § 807.87.

(c) References in this part to regulatory sections of the Code of Federal Regulations are to chapter I of title 21 unless otherwise noted.

(d) Guidance documents referenced in this part are available on the Internet at <http://www.fda.gov/MedicalDevices/DeviceRegulationandGuidance/GuidanceDocuments/default.htm>.

[52 FR 16122, May 1, 1987, as amended at 67 FR 58329, Sept. 16, 2002; 78 FR 18233, Mar. 26, 2013; 79 FR 50552, Aug. 25, 2014]

### § 862.2 Regulation of calibrators.

Many devices classified in this part are intended to be used with a calibrator. A calibrator has a reference value assigned to it which serves as the basis by which test results of patients are derived or calculated. The calibrator for a device may be (a) manufactured and distributed separately from the device with which it is intended to be used, (b) manufactured and distributed as one of several device components, such as in a kit of reagents, or (c) built-in as an integral part of the device. Because of the central role that a calibrator plays in the measurement process and the critical effect calibrators have on accuracy of test results, elsewhere in this part, all three of these types of calibrators (§§ 862.1150 and 862.3200 of this part) are classified into class II, notwithstanding the classification of the device with which it is intended to be used. Thus, a device and

### § 862.3

### 21 CFR Ch. I (4–1–20 Edition)

its calibrator may have different classifications, even if the calibrator is built into the device.

#### **§ 862.3 Effective dates of requirement for premarket approval.**

A device included in this part that is classified into class III (premarket approval) shall not be commercially distributed after the date shown in the regulation classifying the device unless the manufacturer has an approval under section 515 of the act (unless an exemption has been granted under section 520(g)(2) of the act). An approval under section 515 of the act consists of FDA's issuance of an order approving an application for premarket approval (PMA) for the device or declaring completed a product development protocol (PDP) for the device.

(a) Before FDA requires that a device commercially distributed before the enactment date of the amendments, or a device that has been found substantially equivalent to such a device, has an approval under section 515 of the act FDA must promulgate a regulation under section 515(b) of the act requiring such approval, except as provided in paragraph (b) of this section. Such a regulation under section 515(b) of the act shall not be effective during the grace period ending on the 90th day after its promulgation or on the last day of the 30th full calendar month after the regulation that classifies the device into class III is effective, whichever is later. See section 501(f)(2)(B) of the act. Accordingly, unless an effective date of the requirement for premarket approval is shown in the regulation for a device classified into class III in this part, the device may be commercially distributed without FDA's issuance of an order approving a PMA or declaring completed a PDP for the device. If FDA promulgates a regulation under section 515(b) of the act requiring premarket approval for a device, section 501(f)(1)(A) of the act applies to the device.

(b) Any new, not substantially equivalent, device introduced into commercial distribution on or after May 28, 1976, including a device formerly marketed that has been substantially altered, is classified by statute (section 513(f) of the act) into class III without

any grace period and FDA must have issued an order approving a PMA or declaring completed a PDP for the device before the device is commercially distributed unless it is reclassified. If FDA knows that a device being commercially distributed may be a "new" device as defined in this section because of any new intended use or other reasons, FDA may codify the statutory classification of the device into class III for such new use. Accordingly, the regulation for such a class III device states that as of the enactment date of the amendments, May 28, 1976, the device must have an approval under section 515 of the act before commercial distribution.

#### **§ 862.9 Limitations of exemptions from section 510(k) of the Federal Food, Drug, and Cosmetic Act (the act).**

The exemption from the requirement of premarket notification (section 510(k) of the act) for a generic type of class I or II device is only to the extent that the device has existing or reasonably foreseeable characteristics of commercially distributed devices within that generic type or, in the case of in vitro diagnostic devices, only to the extent that misdiagnosis as a result of using the device would not be associated with high morbidity or mortality. Accordingly, manufacturers of any commercially distributed class I or II device for which FDA has granted an exemption from the requirement of premarket notification must still submit a premarket notification to FDA before introducing or delivering for introduction into interstate commerce for commercial distribution the device when:

(a) The device is intended for a use different from the intended use of a legally marketed device in that generic type of device; e.g., the device is intended for a different medical purpose, or the device is intended for lay use where the former intended use was by health care professionals only;

(b) The modified device operates using a different fundamental scientific technology than a legally marketed device in that generic type of device; e.g., a surgical instrument cuts tissue with a laser beam rather than with a sharpened metal blade, or an in

vitro diagnostic device detects or identifies infectious agents by using deoxyribonucleic acid (DNA) probe or nucleic acid hybridization technology rather than culture or immunoassay technology; or

(c) The device is an in vitro device that is intended:

(1) For use in the diagnosis, monitoring, or screening of neoplastic diseases with the exception of immunohistochemical devices;

(2) For use in screening or diagnosis of familial or acquired genetic disorders, including inborn errors of metabolism;

(3) For measuring an analyte that serves as a surrogate marker for screening, diagnosis, or monitoring life-threatening diseases such as acquired immune deficiency syndrome (AIDS), chronic or active hepatitis, tuberculosis, or myocardial infarction or to monitor therapy;

(4) For assessing the risk of cardiovascular diseases;

(5) For use in diabetes management;

(6) For identifying or inferring the identity of a microorganism directly from clinical material;

(7) For detection of antibodies to microorganisms other than immunoglobulin G (IgG) or IgG assays when the results are not qualitative, or are used to determine immunity, or the assay is intended for use in matrices other than serum or plasma;

(8) For noninvasive testing as defined in § 812.3(k) of this chapter; and

(9) For near patient testing (point of care).

[65 FR 2304, Jan. 14, 2000]

## Subpart B—Clinical Chemistry Test Systems

### § 862.1020 Acid phosphatase (total or prostatic) test system.

(a) *Identification.* An acid phosphatase (total or prostatic) test system is a device intended to measure the activity of the acid phosphatase enzyme in plasma and serum.

(b) *Classification.* Class II (special controls). The device is exempt from the premarket notification procedures

in subpart E of part 807 of this chapter subject to the limitations in § 862.9.

[52 FR 16122, May 1, 1987, as amended at 84 FR 71796, Dec. 30, 2019]

### § 862.1025 Adrenocorticotropin hormone (ACTH) test system.

(a) *Identification.* An adrenocorticotropin hormone (ACTH) test system is a device intended to measure adrenocorticotropin hormone in plasma and serum. ACTH measurements are used in the differential diagnosis and treatment of certain disorders of the adrenal glands such as Cushing's syndrome, adrenocortical insufficiency, and the ectopic ACTH syndrome.

(b) *Classification.* Class II.

### § 862.1030 Alanine amino transferase (ALT/SGPT) test system.

(a) *Identification.* An alanine amino transferase (ALT/SGPT) test system is a device intended to measure the activity of the enzyme alanine amino transferase (ALT) (also known as a serum glutamic pyruvic transaminase or SGPT) in serum and plasma. Alanine amino transferase measurements are used in the diagnosis and treatment of certain liver diseases (e.g., viral hepatitis and cirrhosis) and heart diseases.

(b) *Classification.* Class I (general controls). The device is exempt from the premarket notification procedures in subpart E of part 807 of this chapter subject to § 862.9.

[52 FR 16122, May 1, 1987, as amended at 65 FR 2305, Jan. 14, 2000]

### § 862.1035 Albumin test system.

(a) *Identification.* An albumin test system is a device intended to measure the albumin concentration in serum and plasma. Albumin measurements are used in the diagnosis and treatment of numerous diseases involving primarily the liver or kidneys.

(b) *Classification.* Class II.

### § 862.1040 Aldolase test system.

(a) *Identification.* An aldolase test system is a device intended to measure the activity of the enzyme aldolase in serum or plasma. Aldolase measurements are used in the diagnosis and treatment of the early stages of acute

## § 862.1045

hepatitis and for certain muscle diseases such as progressive Duchenne-type muscular dystrophy.

(b) *Classification*. Class I (general controls). The device is exempt from the premarket notification procedures in subpart E of part 807 of this chapter subject to § 862.9.

[52 FR 16122, May 1, 1987, as amended at 65 FR 2305, Jan. 14, 2000]

### § 862.1045 Aldosterone test system.

(a) *Identification*. An aldosterone test system is a device intended to measure the hormone aldosterone in serum and urine. Aldosterone measurements are used in the diagnosis and treatment of primary aldosteronism (a disorder caused by the excessive secretion of aldosterone by the adrenal gland), hypertension caused by primary aldosteronism, selective hypoaldosteronism, edematous states, and other conditions of electrolyte imbalance.

(b) *Classification*. Class II.

### § 862.1050 Alkaline phosphatase or isoenzymes test system.

(a) *Identification*. An alkaline phosphatase or isoenzymes test system is a device intended to measure alkaline phosphatase or its isoenzymes (a group of enzymes with similar biological activity) in serum or plasma. Measurements of alkaline phosphatase or its isoenzymes are used in the diagnosis and treatment of liver, bone, parathyroid, and intestinal diseases.

(b) *Classification*. Class II.

### § 862.1055 Newborn screening test system for amino acids, free carnitine, and acylcarnitines using tandem mass spectrometry.

(a) *Identification*. A newborn screening test system for amino acids, free carnitine, and acylcarnitines using tandem mass spectrometry is a device that consists of stable isotope internal standards, control materials, extraction solutions, flow solvents, instrumentation, software packages, and other reagents and materials. The device is intended for the measurement and evaluation of amino acids, free carnitine, and acylcarnitine concentrations from newborn whole blood filter paper samples. The quantitative anal-

## 21 CFR Ch. I (4–1–20 Edition)

ysis of amino acids, free carnitine, and acylcarnitines and their relationship with each other provides analyte concentration profiles that may aid in screening newborns for one or more in-born errors of amino acid, free carnitine, and acyl-carnitine metabolism.

(b) *Classification*. Class II (special controls). The special control is FDA's guidance document entitled "Class II Special Controls Guidance Document: Newborn Screening Test Systems for Amino Acids, Free Carnitine, and Acylcarnitines Using Tandem Mass Spectrometry." See § 862.1(d) for the availability of this guidance document.

[69 FR 68255, Nov. 24, 2004]

### § 862.1060 Delta-aminolevulinic acid test system.

(a) *Identification*. A delta-aminolevulinic acid test system is a device intended to measure the level of delta-aminolevulinic acid (a precursor of porphyrin) in urine. Delta-aminolevulinic acid measurements are used in the diagnosis and treatment of lead poisoning and certain porphyrias (diseases affecting the liver, gastrointestinal, and nervous systems that are accompanied by increased urinary excretion of various heme compounds including delta-aminolevulinic acid).

(b) *Classification*. Class I (general controls). The device is exempt from premarket notification procedures in subpart E of part 807 of this chapter subject to § 862.9.

[52 FR 16122, May 1, 1987, as amended at 65 FR 2305, Jan. 14, 2000]

### § 862.1065 Ammonia test system.

(a) *Identification*. An ammonia test system is a device intended to measure ammonia levels in blood, serum, and plasma. Ammonia measurements are used in the diagnosis and treatment of severe liver disorders, such as cirrhosis, hepatitis, and Reye's syndrome.

(b) *Classification*. Class I.

### § 862.1070 Amylase test system.

(a) *Identification*. An amylase test system is a device intended to measure the activity of the enzyme amylase in

serum and urine. Amylase measurements are used primarily for the diagnosis and treatment of pancreatitis (inflammation of the pancreas).

(b) *Classification*. Class II.

**§ 862.1075 Androstenedione test system.**

(a) *Identification*. An androstenedione test system is a device intended to measure androstenedione (a substance secreted by the testes, ovary, and adrenal glands) in serum. Androstenedione measurements are used in the diagnosis and treatment of females with excessive levels of androgen (male sex hormone) production.

(b) *Classification*. Class I (general controls). The device is exempt from the premarket notification procedures in subpart E of part 807 of this chapter subject to § 862.9.

[52 FR 16122, May 1, 1987, as amended at 65 FR 2305, Jan. 14, 2000]

**§ 862.1080 Androsterone test system.**

(a) *Identification*. An androsterone test system is a device intended to measure the hormone androsterone in serum, plasma, and urine. Androsterone measurements are used in the diagnosis and treatment of gonadal and adrenal diseases.

(b) *Classification*. Class I (general controls). The device is exempt from the premarket notification procedures in subpart E of part 807 of this chapter subject to § 862.9.

[52 FR 16122, May 1, 1987, as amended at 65 FR 2305, Jan. 14, 2000]

**§ 862.1085 Angiotensin I and renin test system.**

(a) *Identification*. An angiotensin I and renin test system is a device intended to measure the level of angiotensin I generated by renin in plasma. Angiotensin I measurements are used in the diagnosis and treatment of certain types of hypertension.

(b) *Classification*. Class II.

**§ 862.1090 Angiotensin converting enzyme (A.C.E.) test system.**

(a) *Identification*. An angiotensin converting enzyme (A.C.E.) test system is a device intended to measure the activity of angiotensin converting enzyme

in serum and plasma. Measurements obtained by this device are used in the diagnosis and treatment of diseases such as sarcoidosis, a disease characterized by the formation of nodules in the lungs, bones, and skin, and Gaucher's disease, a hereditary disorder affecting the spleen.

(b) *Classification*. Class II (special controls). The device is exempt from the premarket notification procedures in subpart E of part 807 of this chapter subject to the limitations in § 862.9.

[52 FR 16122, May 1, 1987, as amended at 84 FR 71796, Dec. 30, 2019]

**§ 862.1095 Ascorbic acid test system.**

(a) *Identification*. An ascorbic acid test system is a device intended to measure the level of ascorbic acid (vitamin C) in plasma, serum, and urine. Ascorbic acid measurements are used in the diagnosis and treatment of ascorbic acid dietary deficiencies.

(b) *Classification*. Class I (general controls). The device is exempt from the premarket notification procedures in subpart E of part 807 of this chapter subject to § 862.9.

[52 FR 16122, May 1, 1987, as amended at 65 FR 2305, Jan. 14, 2000]

**§ 862.1100 Aspartate amino transferase (AST/SGOT) test system.**

(a) *Identification*. An aspartate amino transferase (AST/SGOT) test system is a device intended to measure the activity of the enzyme aspartate amino transferase (AST) (also known as a serum glutamic oxaloacetic transferase or SGOT) in serum and plasma. Aspartate amino transferase measurements are used in the diagnosis and treatment of certain types of liver and heart disease.

(b) *Classification*. Class II (special controls). The device is exempt from the premarket notification procedures in subpart E of part 807 of this chapter subject to the limitations in § 862.9.

[52 FR 16122, May 1, 1987, as amended at 84 FR 71796, Dec. 30, 2019]

**§ 862.1110 Bilirubin (total or direct) test system.**

(a) *Identification*. A bilirubin (total or direct) test system is a device intended to measure the levels of bilirubin (total

## § 862.1113

or direct) in plasma or serum. Measurements of the levels of bilirubin, an organic compound formed during the normal and abnormal destruction of red blood cells, if used in the diagnosis and treatment of liver, hemolytic hematological, and metabolic disorders, including hepatitis and gall bladder block.

(b) *Classification.* Class II.

## § 862.1113 Bilirubin (total and unbound) in the neonate test system.

(a) *Identification.* A bilirubin (total and unbound) in the neonate test system is a device intended to measure the levels of bilirubin (total and unbound) in the blood (serum) of newborn infants to aid in indicating the risk of bilirubin encephalopathy (kernicterus).

(b) *Classification.* Class I.

[54 FR 30206, July 19, 1989]

## § 862.1115 Urinary bilirubin and its conjugates (nonquantitative) test system.

(a) *Identification.* A urinary bilirubin and its conjugates (nonquantitative) test system is a device intended to measure the levels of bilirubin conjugates in urine. Measurements of urinary bilirubin and its conjugates (nonquantitative) are used in the diagnosis and treatment of certain liver diseases.

(b) *Classification.* Class I (general controls). The device is exempt from the premarket notification procedures in subpart E of part 807 of this chapter subject to § 862.9.

[52 FR 16122, May 1, 1987, as amended at 65 FR 2305, Jan. 14, 2000]

## § 862.1117 B-type natriuretic peptide test system.

(a) *Identification.* The B-type natriuretic peptide (BNP) test system is an in vitro diagnostic device intended to measure BNP in whole blood and plasma. Measurements of BNP are used as an aid in the diagnosis of patients with congestive heart failure.

(b) *Classification.* Class II (special controls). The special control is "Class II Special Control Guidance Document for B-Type Natriuretic Peptide Pre-market Notifications; Final Guidance for Industry and FDA Reviewers."

[66 FR 12734, Feb. 28, 2001]

## 21 CFR Ch. I (4–1–20 Edition)

## § 862.1118 Biotinidase test system.

(a) *Identification.* The biotinidase test system is an in vitro diagnostic device intended to measure the activity of the enzyme biotinidase in blood. Measurements of biotinidase are used in the treatment and diagnosis of biotinidase deficiency, an inborn error of metabolism in infants, characterized by the inability to utilize dietary protein bound vitamin or to recycle endogenous biotin. The deficiency may result in irreversible neurological impairment.

(b) *Classification.* Class II (special controls). The special control is sale, distribution, and use in accordance with the prescription device requirements in § 801.109 of this chapter.

[65 FR 16521, Mar. 29, 2000]

## § 862.1120 Blood gases (P<sub>CO<sub>2</sub></sub>, P<sub>O<sub>2</sub></sub>) and blood pH test system.

(a) *Identification.* A blood gases (P<sub>CO<sub>2</sub></sub>, P<sub>O<sub>2</sub></sub>) and blood pH test system is a device intended to measure certain gases in blood, serum, plasma or pH of blood, serum, and plasma. Measurements of blood gases (P<sub>CO<sub>2</sub></sub>, P<sub>O<sub>2</sub></sub>) and blood pH are used in the diagnosis and treatment of life-threatening acid-base disturbances.

(b) *Classification.* Class II.

## § 862.1130 Blood volume test system.

(a) *Identification.* A blood volume test system is a device intended to measure the circulating blood volume. Blood volume measurements are used in the diagnosis and treatment of shock, hemorrhage, and polycythemia vera (a disease characterized by an absolute increase in erythrocyte mass and total blood volume).

(b) *Classification.* Class I (general controls). The device is exempt from the premarket notification procedures in subpart E of part 807 of this chapter subject to § 862.9.

[52 FR 16122, May 1, 1987, as amended at 65 FR 2305, Jan. 14, 2000]

## § 862.1135 C-peptides of proinsulin test system.

(a) *Identification.* A C-peptides of proinsulin test system is a device intended to measure C-peptides of proinsulin levels in serum, plasma, and urine. Measurements of C-peptides of

proinsulin are used in the diagnosis and treatment of patients with abnormal insulin secretion, including diabetes mellitus.

(b) *Classification*. Class I (general controls). The device is exempt from the premarket notification procedures in subpart E of part 807 of this chapter subject to § 862.9.

[52 FR 16122, May 1, 1987, as amended at 65 FR 2305, Jan. 14, 2000]

**§ 862.1140 Calcitonin test system.**

(a) *Identification*. A calcitonin test system is a device intended to measure the thyroid hormone calcitonin (thyrocalcitonin) levels in plasma and serum. Calcitonin measurements are used in the diagnosis and treatment of diseases involving the thyroid and parathyroid glands, including carcinoma and hyperparathyroidism (excessive activity of the parathyroid gland).

(b) *Classification*. Class II.

**§ 862.1145 Calcium test system.**

(a) *Identification*. A calcium test system is a device intended to measure the total calcium level in serum. Calcium measurements are used in the diagnosis and treatment of parathyroid disease, a variety of bone diseases, chronic renal disease and tetany (intermittent muscular contractions or spasms).

(b) *Classification*. Class II.

**§ 862.1150 Calibrator.**

(a) *Identification*. A calibrator is a device intended for medical purposes for use in a test system to establish points of reference that are used in the determination of values in the measurement of substances in human specimens. (See also § 862.2 in this part.)

(b) *Classification*. Class II (special controls). The device is exempt from the premarket notification procedures in subpart E of part 807 of this chapter subject to the limitations in § 862.9.

[52 FR 16122, May 1, 1987, as amended at 84 FR 71796, Dec. 30, 2019]

**§ 862.1155 Human chorionic gonadotropin (HCG) test system.**

(a) *Human chorionic gonadotropin (HCG) test system intended for the early*

*detection of pregnancy—(1) Identification*. A human chorionic gonadotropin (HCG) test system is a device intended for the early detection of pregnancy is intended to measure HCG, a placental hormone, in plasma or urine.

(2) *Classification*. Class II.

(b) *Human chorionic gonadotropin (HCG) test system intended for any uses other than early detection of pregnancy—*

(1) *Identification*. A human chorionic gonadotropin (HCG) test system is a device intended for any uses other than early detection of pregnancy (such as an aid in the diagnosis, prognosis, and management of treatment of persons with certain tumors or carcinomas) is intended to measure HCG, a placental hormone, in plasma or urine.

(2) *Classification*. Class III.

(3) *Date PMA or notice of completion of a PDP is required*. As of the enactment date of the amendments, May 28, 1976, an approval under section 515 of the act is required before the device described in paragraph (b)(1) may be commercially distributed. See § 862.3.

**§ 862.1160 Bicarbonate/carbon dioxide test system.**

(a) *Identification*. A bicarbonate/carbon dioxide test system is a device intended to measure bicarbonate/carbon dioxide in plasma, serum, and whole blood. Bicarbonate/carbon dioxide measurements are used in the diagnosis and treatment of numerous potentially serious disorders associated with changes in body acid-base balance.

(b) *Classification*. Class II.

**§ 862.1163 Cardiac allograft gene expression profiling test system.**

(a) *Identification*. A cardiac allograft gene expression profiling test system is a device that measures the ribonucleic acid (RNA) expression level of multiple genes and combines this information to yield a signature (pattern, classifier, index, score) to aid in the identification of a low probability of acute cellular rejection (ACR) in heart transplant recipients with stable allograft function.

(b) *Classification*. Class II (special controls). The special control is FDA's guidance document entitled "Class II Special Controls Guidance Document:

## § 862.1165

Cardiac Allograft Gene Expression Profiling Test Systems.” See § 862.1(d) for the availability of this guidance document.

[74 FR 53885, Oct. 21, 2009]

## § 862.1165 Catecholamines (total) test system.

(a) *Identification.* A catecholamines (total) test system is a device intended to determine whether a group of similar compounds (epinephrine, norepinephrine, and dopamine) are present in urine and plasma. Catecholamine determinations are used in the diagnosis and treatment of adrenal medulla and hypertensive disorders, and for catecholamine-secreting tumors (pheochromocytoma, neuroblastoma, ganglioneuroma, and retinoblastoma).

(b) *Classification.* Class I (general controls). The device is exempt from the premarket notification procedures in subpart E of part 807 of this chapter subject to § 862.9.

[52 FR 16122, May 1, 1987, as amended at 65 FR 2305, Jan. 14, 2000]

## § 862.1170 Chloride test system.

(a) *Identification.* A chloride test system is a device intended to measure the level of chloride in plasma, serum, sweat, and urine. Chloride measurements are used in the diagnosis and treatment of electrolyte and metabolic disorders such as cystic fibrosis and diabetic acidosis.

(b) *Classification.* Class II.

## § 862.1175 Cholesterol (total) test system.

(a) *Identification.* A cholesterol (total) test system is a device intended to measure cholesterol in plasma and serum. Cholesterol measurements are used in the diagnosis and treatment of disorders involving excess cholesterol in the blood and lipid and lipoprotein metabolism disorders.

(b) *Classification.* Class I (general controls). The device is exempt from the premarket notification procedures in subpart E of part 807 of this chapter subject to § 862.9.

[52 FR 16122, May 1, 1987, as amended at 65 FR 2305, Jan. 14, 2000]

## 21 CFR Ch. I (4–1–20 Edition)

## § 862.1177 Cholyglycine test system.

(a) *Identification.* A cholyglycine test system is a device intended to measure the bile acid cholyglycine in serum. Measurements obtained by this device are used in the diagnosis and treatment of liver disorders, such as cirrhosis or obstructive liver disease.

(b) *Classification.* Class II.

## § 862.1180 Chymotrypsin test system.

(a) *Identification.* A chymotrypsin test system is a device intended to measure the activity of the enzyme chymotrypsin in blood and other body fluids and in feces. Chymotrypsin measurements are used in the diagnosis and treatment of pancreatic exocrine insufficiency.

(b) *Classification.* Class I (general controls). The device is exempt from the premarket notification procedures in subpart E of part 807 of this chapter subject to § 862.9.

[52 FR 16122, May 1, 1987, as amended at 65 FR 2305, Jan. 14, 2000]

## § 862.1185 Compound S (11-dioxycortisol) test system.

(a) *Identification.* A compound S (11-dioxycortisol) test system is a device intended to measure the level of compound S (11-dioxycortisol) in plasma. Compound S is a steroid intermediate in the biosynthesis of the adrenal hormone cortisol. Measurements of compound S are used in the diagnosis and treatment of certain adrenal and pituitary gland disorders resulting in clinical symptoms of masculinization and hypertension.

(b) *Classification.* Class I (general controls). The device is exempt from the premarket notification procedures in subpart E of part 807 of this chapter subject to § 862.9.

[52 FR 16122, May 1, 1987, as amended at 65 FR 2305, Jan. 14, 2000]

## § 862.1187 Conjugated sulfolithocholic acid (SLCG) test system.

(a) *Identification.* A conjugated sulfolithocholic acid (SLCG) test system is a device intended to measure the bile acid SLCG in serum. Measurements obtained by this device are used in the diagnosis and treatment of liver



**Food and Drug Administration, HHS**

**§ 862.1215**

disorders, such as cirrhosis or obstructive liver disease.

(b) *Classification.* Class II.

**§ 862.1190 Copper test system.**

(a) *Identification.* A copper test system is a device intended to measure copper levels in plasma, serum, and urine. Measurements of copper are used in the diagnosis and treatment of anemia, infections, inflammations, and Wilson's disease (a hereditary disease primarily of the liver and nervous system). Test results are also used in monitoring patients with Hodgkin's disease (a disease primarily of the lymph system).

(b) *Classification.* Class I (general controls). The device is exempt from the premarket notification procedures in subpart E of part 807 of this chapter subject to the limitations in § 862.9.

[52 FR 16122, May 1, 1987, as amended at 53 FR 21449, June 8, 1988; 66 FR 38787, July 25, 2001]

**§ 862.1195 Corticoids test system.**

(a) *Identification.* A corticoids test system is a device intended to measure the levels of corticoids (hormones of the adrenal cortex) in serum and plasma. Measurements of corticoids are used in the diagnosis and treatment of disorders of the cortex of the adrenal glands, especially those associated with hypertension and electrolyte disturbances.

(b) *Classification.* Class I (general controls). The device is exempt from the premarket notification procedures in subpart E of part 807 of this chapter subject to § 862.9.

[52 FR 16122, May 1, 1987, as amended at 65 FR 2305, Jan. 14, 2000]

**§ 862.1200 Corticosterone test system.**

(a) *Identification.* A corticosterone test system is a device intended to measure corticosterone (a steroid secreted by the adrenal gland) levels in plasma. Measurements of corticosterone are used in the diagnosis and treatment of adrenal disorders such as adrenal cortex disorders and blocks in cortisol synthesis.

(b) *Classification.* Class I (general controls). The device is exempt from the premarket notification procedures in

subpart E of part 807 of this chapter subject to § 862.9.

[52 FR 16122, May 1, 1987, as amended at 65 FR 2305, Jan. 14, 2000]

**§ 862.1205 Cortisol (hydrocortisone and hydroxycorticosterone) test system.**

(a) *Identification.* A cortisol (hydrocortisone and hydroxycorticosterone) test system is a device intended to measure the cortisol hormones secreted by the adrenal gland in plasma and urine. Measurements of cortisol are used in the diagnosis and treatment of disorders of the adrenal gland.

(b) *Classification.* Class II.

**§ 862.1210 Creatine test system.**

(a) *Identification.* A creatine test system is a device intended to measure creatine (a substance synthesized in the liver and pancreas and found in biological fluids) in plasma, serum, and urine. Measurements of creatine are used in the diagnosis and treatment of muscle diseases and endocrine disorders including hyperthyroidism.

(b) *Classification.* Class I (general controls). The device is exempt from the premarket notification procedures in subpart E of part 807 of this chapter subject to the limitations in § 862.9.

[52 FR 16122, May 1, 1987, as amended at 53 FR 21449, June 8, 1988; 66 FR 38787, July 25, 2001]

**§ 862.1215 Creatine phosphokinase/creatinase kinase or isoenzymes test system.**

(a) *Identification.* A creatine phosphokinase/creatinase kinase or isoenzymes test system is a device intended to measure the activity of the enzyme creatine phosphokinase or its isoenzymes (a group of enzymes with similar biological activity) in plasma and serum. Measurements of creatine phosphokinase and its isoenzymes are used in the diagnosis and treatment of myocardial infarction and muscle diseases such as progressive, Duchenne-type muscular dystrophy.

(b) *Classification.* Class II.

## § 862.1220

## 21 CFR Ch. I (4–1–20 Edition)

### § 862.1220 Acute kidney injury test system.

(a) *Identification.* An acute kidney injury test system is a device that is intended to measure one or more analytes in human samples as an aid in the assessment of a patient's risk for developing acute kidney injury. Test results are intended to be used in conjunction with other clinical and diagnostic findings, consistent with professional standards of practice, including confirmation by alternative methods.

(b) *Classification.* Class II (special controls). The special controls for this device are:

(1) Premarket notification submissions must detail an appropriate end user device training program that will be offered while marketing the device as part of your efforts to mitigate the risk of incorrect interpretation of test results.

(2) As part of the risk management activities performed as part of your 21 CFR 820.30 design controls, you must document the appropriate end user device training program provided in your premarket notification submission to satisfy special control 21 CFR 862.1220(b)(1) that will be offered while marketing the device as part of your efforts to mitigate the risk of incorrect interpretation of test results.

(3) Robust clinical data demonstrating the positive predictive value, negative predictive value, sensitivity and specificity of the test in the intended use population must be submitted as part of the premarket notification submission.

[82 FR 50072, Oct. 30, 2017]

### § 862.1225 Creatinine test system.

(a) *Identification.* A creatinine test system is a device intended to measure creatinine levels in plasma and urine. Creatinine measurements are used in the diagnosis and treatment of renal diseases, in monitoring renal dialysis, and as a calculation basis for measuring other urine analytes.

(b) *Classification.* Class II.

### § 862.1230 Cyclic AMP test system.

(a) *Identification.* A cyclic AMP test system is a device intended to measure the level of adenosine 3', 5'-

monophosphate (cyclic AMP) in plasma, urine, and other body fluids. Cyclic AMP measurements are used in the diagnosis and treatment of endocrine disorders, including hyperparathyroidism (overactivity of the parathyroid gland). Cyclic AMP measurements may also be used in the diagnosis and treatment of Graves' disease (a disorder of the thyroid) and in the differentiation of causes of hypercalcemia (elevated levels of serum calcium.)

(b) *Classification.* Class II.

### § 862.1235 Cyclosporine test system.

(a) *Identification.* A cyclosporine test system is a device intended to quantitatively determine cyclosporine concentrations as an aid in the management of transplant patients receiving therapy with this drug. This generic type of device includes immunoassays and chromatographic assays for cyclosporine.

(b) *Classification.* Class II (special controls). The special control is "Class II Special Controls Guidance Document: Cyclosporine and Tacrolimus Assays; Guidance for Industry and FDA." See § 862.1(d) for the availability of this guidance document.

[67 FR 58329, Sept. 16, 2002]

### § 862.1240 Cystine test system.

(a) *Identification.* A cystine test system is a device intended to measure the amino acid cystine in urine. Cystine measurements are used in the diagnosis of cystinuria (occurrence of cystine in urine). Patients with cystinuria frequently develop kidney calculi (stones).

(b) *Classification.* Class I (general controls). The device is exempt from the premarket notification procedures in subpart E of part 807 of this chapter subject to § 862.9.

[52 FR 16122, May 1, 1987, as amended at 65 FR 2305, Jan. 14, 2000]

### § 862.1245 Dehydroepiandrosterone (free and sulfate) test system.

(a) *Identification.* A dehydroepiandrosterone (free and sulfate) test system is a device intended to measure dehydroepiandrosterone (DHEA) and its sulfate in urine, serum, plasma, and amniotic fluid.

Dehydroepiandrosterone measurements are used in the diagnosis and treatment of DHEA-secreting adrenal carcinomas.

(b) *Classification*. Class I (general controls). The device is exempt from the premarket notification procedures in subpart E of part 807 of this chapter subject to § 862.9.

[52 FR 16122, May 1, 1987, as amended at 65 FR 2306, Jan. 14, 2000]

**§ 862.1250 Desoxycorticosterone test system.**

(a) *Identification*. A desoxycorticosterone test system is a device intended to measure desoxycorticosterone (DOC) in plasma and urine. DOC measurements are used in the diagnosis and treatment of patients with hypermineralocorticoidism (excess retention of sodium and loss of potassium) and other disorders of the adrenal gland.

(b) *Classification*. Class I (general controls). The device is exempt from the premarket notification procedures in subpart E of part 807 of this chapter subject to § 862.9.

[52 FR 16122, May 1, 1987, as amended at 65 FR 2306, Jan. 14, 2000]

**§ 862.1255 2,3-Diphosphoglyceric acid test system.**

(a) *Identification*. A 2,3-diphosphoglyceric acid test system is a device intended to measure 2,3-diphosphoglyceric acid (2,3-DPG) in erythrocytes (red blood cells). Measurements of 2,3-diphosphoglyceric acid are used in the diagnosis and treatment of blood disorders that affect the delivery of oxygen by erythrocytes to tissues and in monitoring the quality of stored blood.

(b) *Classification*. Class I (general controls). The device is exempt from the premarket notification procedures in subpart E of part 807 of this chapter subject to the limitations in § 862.9.

[52 FR 16122, May 1, 1987, as amended at 53 FR 21449, June 8, 1988; 66 FR 38787, July 25, 2001]

**§ 862.1260 Estradiol test system.**

(a) *Identification*. An estradiol test system is a device intended to measure estradiol, an estrogenic steroid, in

plasma. Estradiol measurements are used in the diagnosis and treatment of various hormonal sexual disorders and in assessing placental function in complicated pregnancy.

(b) *Classification*. Class I (general controls). The device is exempt from the premarket notification procedures in subpart E of part 807 of this chapter subject to § 862.9.

[52 FR 16122, May 1, 1987, as amended at 65 FR 2306, Jan. 14, 2000]

**§ 862.1265 Estriol test system.**

(a) *Identification*. An estriol test system is a device intended to measure estriol, an estrogenic steroid, in plasma, serum, and urine of pregnant females. Estriol measurements are used in the diagnosis and treatment of fetoplacental distress in certain cases of high-risk pregnancy.

(b) *Classification*. Class I (general controls). The device is exempt from the premarket notification procedures in subpart E of part 807 of this chapter subject to § 862.9.

[52 FR 16122, May 1, 1987, as amended at 65 FR 2306, Jan. 14, 2000]

**§ 862.1270 Estrogens (total, in pregnancy) test system.**

(a) *Identification*. As estrogens (total, in pregnancy) test system is a device intended to measure total estrogens in plasma, serum, and urine during pregnancy. The device primarily measures estrone plus estradiol. Measurements of total estrogens are used to aid in the diagnosis and treatment of fetoplacental distress in certain cases of high-risk pregnancy.

(b) *Classification*. Class I (general controls). The device is exempt from the premarket notification procedures in subpart E of part 807 of this chapter subject to § 862.9.

[52 FR 16122, May 1, 1987, as amended at 65 FR 2306, Jan. 14, 2000]

**§ 862.1275 Estrogens (total, nonpregnancy) test system.**

(a) *Identification*. As estrogens (total, nonpregnancy) test system is a device intended to measure the level of estrogens (total estrone, estradiol, and estriol) in plasma, serum, and urine of

## § 862.1280

males and nonpregnant females. Measurement of estrogens (total, nonpregnancy) is used in the diagnosis and treatment of numerous disorders, including infertility, amenorrhea (absence of menses) differentiation of primary and secondary ovarian malfunction, estrogen secreting testicular and ovarian tumors, and precocious puberty in females.

(b) *Classification*. Class I (general controls). The device is exempt from the premarket notification procedures in subpart E of part 807 of this chapter subject to § 862.9.

[52 FR 16122, May 1, 1987, as amended at 65 FR 2306, Jan. 14, 2000]

## § 862.1280 Estrone test system.

(a) *Identification*. An estrone test system is a device intended to measure estrone, an estrogenic steroid, in plasma. Estrone measurements are used in the diagnosis and treatment of numerous disorders, including infertility, amenorrhea, differentiation of primary and secondary ovarian malfunction, estrogen secreting testicular and ovarian tumors, and precocious puberty in females.

(b) *Classification*. Class I (general controls). The device is exempt from the premarket notification procedures in subpart E of part 807 of this chapter subject to § 862.9.

[52 FR 16122, May 1, 1987, as amended at 65 FR 2306, Jan. 14, 2000]

## § 862.1285 Etiocholanolone test system.

(a) *Identification*. An etiocholanolone test system is a device intended to measure etiocholanolone in serum and urine. Etiocholanolone is a metabolic product of the hormone testosterone and is excreted in the urine. Etiocholanolone measurements are used in the diagnosis and treatment of disorders of the testes and ovaries.

(b) *Classification*. Class I (general controls). The device is exempt from the premarket notification procedures in subpart E of part 807 of this chapter subject to § 862.9.

[52 FR 16122, May 1, 1987, as amended at 65 FR 2306, Jan. 14, 2000]

## 21 CFR Ch. I (4–1–20 Edition)

## § 862.1290 Fatty acids test system.

(a) *Identification*. A fatty acids test system is a device intended to measure fatty acids in plasma and serum. Measurements of fatty acids are used in the diagnosis and treatment of various disorders of lipid metabolism.

(b) *Classification*. Class I (general controls). The device is exempt from the premarket notification procedures in subpart E of part 807 of this chapter subject to the limitations in § 862.9.

[52 FR 16122, May 1, 1987, as amended at 53 FR 21449, June 8, 1988; 66 FR 38787, July 25, 2001]

## § 862.1295 Folic acid test system.

(a) *Identification*. A folic acid test system is a device intended to measure the vitamin folic acid in plasma and serum. Folic acid measurements are used in the diagnosis and treatment of megaloblastic anemia, which is characterized by the presence of megaloblasts (an abnormal red blood cell series) in the bone marrow.

(b) *Classification*. Class II.

[52 FR 16122, May 1, 1987; 53 FR 11645, Apr. 8, 1988]

## § 862.1300 Follicle-stimulating hormone test system.

(a) *Identification*. A follicle-stimulating hormone test system is a device intended to measure follicle-stimulating hormone (FSH) in plasma, serum, and urine. FSH measurements are used in the diagnosis and treatment of pituitary gland and gonadal disorders.

(b) *Classification*. Class I (general controls). The device is exempt from the premarket notification procedures in subpart E of part 807 of this chapter subject to § 862.9.

[52 FR 16122, May 1, 1987, as amended at 65 FR 2306, Jan. 14, 2000]

## § 862.1305 Formiminoglutamic acid (FIGLU) test system.

(a) *Identification*. A formiminoglutamic acid (FIGLU) test system is a device intended to measure formiminoglutamic acid in urine. FIGLU measurements obtained by this device are used in the diagnosis of anemias, such as pernicious anemia and congenital hemolytic anemia.

## Food and Drug Administration, HHS

## § 862.1340

(b) *Classification*. Class I (general controls). The device is exempt from the premarket notification procedures in subpart E of part 807 of this chapter subject to the limitations in § 862.9.

[52 FR 16122, May 1, 1987, as amended at 53 FR 21449, June 8, 1988; 66 FR 38787, July 25, 2001]

### § 862.1310 Galactose test system.

(a) *Identification*. A galactose test system is a device intended to measure galactose in blood and urine. Galactose measurements are used in the diagnosis and treatment of the hereditary disease galactosemia (a disorder of galactose metabolism) in infants.

(b) *Classification*. Class I.

### § 862.1315 Galactose-1-phosphate uridyl transferase test system.

(a) *Identification*. A galactose-1-phosphate uridyl transferase test system is a device intended to measure the activity of the enzyme galactose-1-phosphate uridyl transferase in erythrocytes (red blood cells). Measurements of galactose-1-phosphate uridyl transferase are used in the diagnosis and treatment of the hereditary disease galactosemia (disorder of galactose metabolism) in infants.

(b) *Classification*. Class II.

### § 862.1320 Gastric acidity test system.

(a) *Identification*. A gastric acidity test system is a device intended to measure the acidity of gastric fluid. Measurements of gastric acidity are used in the diagnosis and treatment of patients with peptic ulcer, Zollinger-Ellison syndrome (peptic ulcer due to gastrin-secreting tumor of the pancreas), and related gastric disorders.

(b) *Classification*. Class I (general controls). The device is exempt from the premarket notification procedures in subpart E of part 807 of this chapter subject to the limitations in § 862.9.

[52 FR 16122, May 1, 1987, as amended at 53 FR 21449, June 8, 1988; 66 FR 38787, July 25, 2001]

### § 862.1325 Gastrin test system.

(a) *Identification*. A gastrin test system is a device intended to measure the hormone gastrin in plasma and serum. Measurements of gastrin are

used in the diagnosis and treatment of patients with ulcers, pernicious anemia, and the Zollinger-Ellison syndrome (peptic ulcer due to a gastrin-secreting tumor of the pancreas).

(b) *Classification*. Class I (general controls). The device is exempt from the premarket notification procedures in subpart E of part 807 of this chapter subject to § 862.9.

[52 FR 16122, May 1, 1987, as amended at 65 FR 2306, Jan. 14, 2000]

### § 862.1330 Globulin test system.

(a) *Identification*. A globulin test system is a device intended to measure globulins (proteins) in plasma and serum. Measurements of globulin are used in the diagnosis and treatment of patients with numerous illnesses including severe liver and renal disease, multiple myeloma, and other disorders of blood globulins.

(b) *Classification*. Class I (general controls). The device is exempt from the premarket notification procedures in subpart E of part 807 of this chapter subject to § 862.9.

[52 FR 16122, May 1, 1987, as amended at 65 FR 2306, Jan. 14, 2000]

### § 862.1335 Glucagon test system.

(a) *Identification*. A glucagon test system is a device intended to measure the pancreatic hormone glucagon in plasma and serum. Glucagon measurements are used in the diagnosis and treatment of patients with various disorders of carbohydrate metabolism, including diabetes mellitus, hypoglycemia, and hyperglycemia.

(b) *Classification*. Class I (general controls). The device is exempt from the premarket notification procedures in subpart E of part 807 of this chapter subject to § 862.9.

[52 FR 16122, May 1, 1987, as amended at 65 FR 2306, Jan. 14, 2000]

### § 862.1340 Urinary glucose (non-quantitative) test system.

(a) *Identification*. A urinary glucose (nonquantitative) test system is a device intended to measure glucosuria (glucose in urine). Urinary glucose (nonquantitative) measurements are used in the diagnosis and treatment of

**§ 862.1345**

carbohydrate metabolism disorders including diabetes mellitus, hypoglycemia, and hyperglycemia.

(b) *Classification*. Class II.

**§ 862.1345 Glucose test system.**

(a) *Identification*. A glucose test system is a device intended to measure glucose quantitatively in blood and other body fluids. Glucose measurements are used in the diagnosis and treatment of carbohydrate metabolism disorders including diabetes mellitus, neonatal hypoglycemia, and idiopathic hypoglycemia, and of pancreatic islet cell carcinoma.

(b) *Classification*. Class II (special controls). The device is exempt from the premarket notification procedures in subpart E of part 807 of this chapter subject to the limitations in § 862.9.

[52 FR 16122, May 1, 1987, as amended at 84 FR 71796, Dec. 30, 2019]

**§ 862.1350 Continuous glucose monitor secondary display.**

(a) *Identification*. A continuous glucose monitor secondary display is identified as a device intended to be used for passive real-time monitoring of continuous glucose monitoring data. It must not be capable of serving as a stand-alone primary display device. The primary display device, which is not a part of the continuous glucose monitor secondary display, directly receives the glucose data (for example, it communicates directly with transmitter) from the continuous glucose meter, which is not a part of the continuous glucose monitor secondary display, and is the primary means of viewing the continuous glucose monitor data and alerting the patient to a low or high glucose value. A continuous glucose monitor secondary display can be used by caregivers of people with diabetes to monitor a person's continuous glucose monitoring data. A device is not a continuous glucose monitor secondary display if the data from the primary display device is modified (for example, predicting future glucose values) or the patient can use the secondary display in lieu of a primary display device (for example, the primary display device is blinded or the primary display does not have to be near

**21 CFR Ch. I (4–1–20 Edition)**

the person wearing the sensor and transmitter).

(b) *Classification*. Class II (special controls). The device is exempt from the premarket notification procedures in subpart E of part 807 of this chapter subject to the limitations in § 862.9. The special controls for this device are:

(1) Devices being marketed must include appropriate measures to protect against unauthorized access to data and unauthorized modification of data.

(2) The labeling must prominently and conspicuously display a warning that states “Dosing decisions should not be made based on this device. The user should follow instructions on the continuous glucose monitoring system.”

(3) The labeling for the device must include a statement that reads “This device is not intended to replace self-monitoring practices as advised by a physician.”

[82 FR 13550, Mar. 14, 2017, as amended at 84 FR 71796, Dec. 30, 2019]

**§ 862.1358 Insulin therapy adjustment device.**

(a) *Identification*. An insulin therapy adjustment device is a device intended to incorporate biological inputs, including glucose measurement data from a continuous glucose monitor, to recommend insulin therapy adjustments as an aid in optimizing insulin therapy regimens for patients with diabetes mellitus.

(b) *Classification*. Class II (special controls). The special controls for this device are:

(1) Design verification and validation must include the following:

(i) A complete description of the required data inputs, including time-frame over which data inputs must be collected and number of data points required for accurate recommendations;

(ii) A complete description of the types of device outputs and insulin therapy adjustment recommendations, including how the recommendations are generated;

(iii) Robust data demonstrating the clinical validity of the device outputs and insulin therapy recommendations;

(iv) A robust assessment of all input data specifications, including accuracy requirements for continuous glucose

monitors and other devices generating data inputs, to ensure accurate and reliable therapy adjustment recommendations. This assessment must include adequate clinical justification for each specification;

(v) A detailed strategy to ensure secure and reliable means of data transmission to and from the device, including data integrity checks, accuracy checks, reliability checks, and security measures;

(vi) Robust data demonstrating that users can understand and appropriately interpret recommendations generated by the device; and

(vii) An appropriate mitigation strategy to minimize the occurrence of dosing recommendation errors, and to mitigate the risk to patients of any residual dosing recommendation errors to a clinically acceptable level.

(2) The device must not be intended for use in implementing automated insulin dosing.

(3) Your 21 CFR 809.10(b) labeling must include:

(i) The identification of specific insulin formulations that have been demonstrated to be compatible with use of the device;

(ii) A detailed description of the specifications of compatible devices that provide acceptable input data (e.g., continuous glucose monitors, insulin pumps) used to provide accurate and reliable therapy adjustment recommendations;

(iii) A detailed description of all types of required data (inputs) and dosing recommendations (outputs) that are provided by the device; and

(iv) A description of device limitations, and instructions to prevent possible disruption of accurate therapy adjustment recommendations (e.g., time zone changes due to travel).

[83 FR 54874, Nov. 1, 2018]

**§ 862.1360 Gamma-glutamyl transpeptidase and isoenzymes test system.**

(a) *Identification.* A gamma-glutamyl transpeptidase and isoenzymes test system is a device intended to measure the activity of the enzyme gamma-glutamyl transpeptidase (GGTP) in plasma and serum. Gamma-glutamyl transpeptidase and isoenzymes meas-

urements are used in the diagnosis and treatment of liver diseases such as alcoholic cirrhosis and primary and secondary liver tumors.

(b) *Classification.* Class I (general controls). The device is exempt from the premarket notification procedures in subpart E of part 807 of this chapter subject to § 862.9.

[52 FR 16122, May 1, 1987, as amended at 65 FR 2306, Jan. 14, 2000]

**§ 862.1365 Glutathione test system.**

(a) *Identification.* A glutathione test system is a device intended to measure glutathione (the tripeptide of glycine, cysteine, and glutamic acid) in erythrocytes (red blood cells). Glutathione measurements are used in the diagnosis and treatment of certain drug-induced hemolytic (erythrocyte destroying) anemias due to an inherited enzyme deficiency.

(b) *Classification.* Class I (general controls). The device is exempt from the premarket notification procedures in subpart E of part 807 of this chapter subject to the limitations in § 862.9.

[52 FR 16122, May 1, 1987, as amended at 53 FR 21449, June 8, 1988; 66 FR 38787, July 25, 2001]

**§ 862.1370 Human growth hormone test system.**

(a) *Identification.* A human growth hormone test system is a device intended to measure the levels of human growth hormone in plasma. Human growth hormone measurements are used in the diagnosis and treatment of disorders involving the anterior lobe of the pituitary gland.

(b) *Classification.* Class I (general controls). The device is exempt from the premarket notification procedures in subpart E of part 807 of this chapter subject to § 862.9.

[52 FR 16122, May 1, 1987, as amended at 65 FR 2306, Jan. 14, 2000]

**§ 862.1373 Hemoglobin A1c test system.**

(a) *Identification.* A hemoglobin A1c test system is a device used to measure the percentage concentration of hemoglobin A1c in blood. Measurement of hemoglobin A1c is used as an aid in the diagnosis of diabetes mellitus and as an

**§ 862.1375**

aid in the identification of patients at risk for developing diabetes mellitus.

(b) *Classification.* Class II (special controls). The special controls for this device are:

(1) The device must have initial and annual standardization verification by a certifying glycohemoglobin standardization organization deemed acceptable by FDA.

(2) The premarket notification submission must include performance testing to evaluate precision, accuracy, linearity, and interference, including the following:

(i) Performance testing of device precision must, at a minimum, use blood samples with concentrations near 5.0 percent, 6.5 percent, 8.0 percent, and 12 percent hemoglobin A1c. This testing must evaluate precision over a minimum of 20 days using at least three lots of the device and three instruments, as applicable.

(ii) Performance testing of device accuracy must include a minimum of 120 blood samples that span the measuring interval of the device and compare results of the new device to results of a standardized test method. Results must demonstrate little or no bias versus the standardized method.

(iii) Total error of the new device must be evaluated using single measurements by the new device compared to results of the standardized test method, and this evaluation must demonstrate a total error less than or equal to 6 percent.

(iv) Performance testing must demonstrate that there is little to no interference from common hemoglobin variants, including Hemoglobin C, Hemoglobin D, Hemoglobin E, Hemoglobin A2, and Hemoglobin S.

(3) When assay interference from Hemoglobin F or interference with other hemoglobin variants with low frequency in the population is observed, a warning statement must be placed in a black box and must appear in all labeling material for these devices describing the interference and any affected populations.

[79 FR 50551, Aug. 25, 2014]

**§ 862.1375 Histidine test system.**

(a) *Identification.* A histidine test system is a device intended to measure

**21 CFR Ch. I (4–1–20 Edition)**

free histidine (an amino acid) in plasma and urine. Histidine measurements are used in the diagnosis and treatment of hereditary histidinemia characterized by excess histidine in the blood and urine often resulting in mental retardation and disordered speech development.

(b) *Classification.* Class I (general controls). The device is exempt from the premarket notification procedures in subpart E of part 807 of this chapter subject to § 862.9.

[52 FR 16122, May 1, 1987, as amended at 65 FR 2306, Jan. 14, 2000]

**§ 862.1377 Urinary homocystine (non-quantitative) test system.**

(a) *Identification.* A urinary homocystine (nonquantitative) test system is a device intended to identify homocystine (an analogue of the amino acid cystine) in urine. The identification of urinary homocystine is used in the diagnosis and treatment of homocystinuria (homocystine in urine), a heritable metabolic disorder which may cause mental retardation.

(b) *Classification.* Class II.

**§ 862.1380 Hydroxybutyric dehydrogenase test system.**

(a) *Identification.* A hydroxybutyric dehydrogenase test system is a device intended to measure the activity of the enzyme alpha-hydroxybutyric dehydrogenase (HBD) in plasma or serum. HBD measurements are used in the diagnosis and treatment of myocardial infarction, renal damage (such as rejection of transplants), certain hematological diseases (such as acute leukemias and megaloblastic anemias) and, to a lesser degree, liver disease.

(b) *Classification.* Class I (general controls). The device is exempt from the premarket notification procedures in subpart E of part 807 of this chapter subject to the limitations in § 862.9.

[52 FR 16122, May 1, 1987, as amended at 53 FR 21449, June 8, 1988; 66 FR 38787, July 25, 2001]

**§ 862.1385 17-Hydroxycorticosteroids (17-ketogenic steroids) test system.**

(a) *Identification.* A 17-hydroxycorticosteroids (17-ketogenic steroids) test system is a device intended to



Food and Drug Administration, HHS

§ 862.1410

measure corticosteroids that possess a dihydroxyacetone

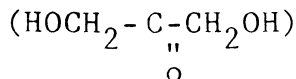

moiety on the steroid nucleus in urine. Corticosteroids with this chemical configuration include cortisol, cortisone 11-desoxycortisol, desoxycorticosterone, and their tetrahydroderivatives. This group of hormones is synthesized by the adrenal gland. Measurements of 17-hydroxycorticosteroids (17-ketogenic steroids) are used in the diagnosis and treatment of various diseases of the adrenal or pituitary glands and gonadal disorders.

(b) *Classification.* Class I (general controls). The device is exempt from the premarket notification procedures in subpart E of part 807 of this chapter subject to § 862.9.

[52 FR 16122, May 1, 1987; 52 FR 29468, Aug. 7, 1987, as amended at 65 FR 2306, Jan. 14, 2000]

§ 862.1390 5-Hydroxyindole acetic acid/serotonin test system.

(a) *Identification.* A 5-hydroxyindole acetic acid/serotonin test system is a device intended to measure 5-hydroxyindole acetic acid/serotonin in urine. Measurements of 5-hydroxyindole acetic acid/serotonin are used in the diagnosis and treatment of carcinoid tumors of endocrine tissue.

(b) *Classification.* Class I (general controls). The device is exempt from the premarket notification procedures in subpart E of part 807 of this chapter subject to § 862.9.

[52 FR 16122, May 1, 1987, as amended at 65 FR 2306, Jan. 14, 2000]

§ 862.1395 17-Hydroxyprogesterone test system.

(a) *Identification.* A 17-hydroxyprogesterone test system is a device intended to measure 17-hydroxyprogesterone (a steroid) in plasma and serum. Measurements of 17-hydroxyprogesterone are used in the diagnosis and treatment of various disorders of the adrenal glands or the ovaries.

(b) *Classification.* Class I (general controls). The device is exempt from the

premarket notification procedures in subpart E of part 807 of this chapter subject to § 862.9.

[52 FR 16122, May 1, 1987, as amended at 65 FR 2306, Jan. 14, 2000]

§ 862.1400 Hydroxyproline test system.

(a) *Identification.* A hydroxyproline test system is a device intended to measure the amino acid hydroxyproline in urine. Hydroxyproline measurements are used in the diagnosis and treatment of various collagen (connective tissue) diseases, bone disease such as Paget's disease, and endocrine disorders such as hyperparathyroidism and hyperthyroidism.

(b) *Classification.* Class I (general controls). The device is exempt from the premarket notification procedures in subpart E of part 807 of this chapter subject to § 862.9.

[52 FR 16122, May 1, 1987, as amended at 65 FR 2306, Jan. 14, 2000]

§ 862.1405 Immunoreactive insulin test system.

(a) *Identification.* An immunoreactive insulin test system is a device intended to measure immunoreactive insulin in serum and plasma. Immunoreactive insulin measurements are used in the diagnosis and treatment of various carbohydrate metabolism disorders, including diabetes mellitus, and hypoglycemia.

(b) *Classification.* Class I (general controls). The device is exempt from the premarket notification procedures in subpart E of part 807 of this chapter subject to § 862.9.

[52 FR 16122, May 1, 1987, as amended at 65 FR 2306, Jan. 14, 2000]

§ 862.1410 Iron (non-heme) test system.

(a) *Identification.* An iron (non-heme) test system is a device intended to measure iron (non-heme) in serum and plasma. Iron (non-heme) measurements are used in the diagnosis and treatment of diseases such as iron deficiency anemia, hemochromatosis (a disease associated with widespread deposit in the tissues of two iron-containing pigments, hemosiderin and

## § 862.1415

hemofuscin, and characterized by pigmentation of the skin), and chronic renal disease.

(b) *Classification*. Class I (general controls). The device is exempt from the premarket notification procedures in subpart E of part 807 of this chapter subject to the limitations in § 862.9.

[52 FR 16122, May 1, 1987, as amended at 84 FR 71796, Dec. 30, 2019]

### § 862.1415 Iron-binding capacity test system.

(a) *Identification*. An iron-binding capacity test system is a device intended to measure iron-binding capacity in serum. Iron-binding capacity measurements are used in the diagnosis and treatment of anemia.

(b) *Classification*. Class I (general controls). The device is exempt from the premarket notification procedures in subpart E of part 807 of this chapter subject to the limitations in § 862.9.

[52 FR 16122, May 1, 1987, as amended at 84 FR 71796, Dec. 30, 2019]

### § 862.1420 Isocitric dehydrogenase test system.

(a) *Identification*. An isocitric dehydrogenase test system is a device intended to measure the activity of the enzyme isocitric dehydrogenase in serum and plasma. Isocitric dehydrogenase measurements are used in the diagnosis and treatment of liver disease such as viral hepatitis, cirrhosis, or acute inflammation of the biliary tract; pulmonary disease such as pulmonary infarction (local arrest or sudden insufficiency of the blood supply to the lungs), and diseases associated with pregnancy.

(b) *Classification*. Class I (general controls). The device is exempt from the premarket notification procedures in subpart E of part 807 of this chapter subject to the limitations in § 862.9.

[52 FR 16122, May 1, 1987, as amended at 53 FR 21449, June 8, 1988; 66 FR 38788, July 25, 2001]

### § 862.1430 17-Ketosteroids test system.

(a) *Identification*. A 17-ketosteroids test system is a device intended to measure 17-ketosteroids in urine. Measurements of 17-ketosteroids are used in the diagnosis and treatment of dis-

## 21 CFR Ch. I (4–1–20 Edition)

orders of the adrenal cortex and gonads and of other endocrine disorders, including hypertension, diabetes, and hypothyroidism.

(b) *Classification*. Class I (general controls). The device is exempt from the premarket notification procedures in subpart E of part 807 of this chapter subject to § 862.9.

[52 FR 16122, May 1, 1987, as amended at 65 FR 2307, Jan. 14, 2000]

### § 862.1435 Ketones (nonquantitative) test system.

(a) *Identification*. A ketones (non-quantitative) test system is a device intended to identify ketones in urine and other body fluids. Identification of ketones is used in the diagnosis and treatment of acidosis (a condition characterized by abnormally high acidity of body fluids) or ketosis (a condition characterized by increased production of ketone bodies such as acetone) and for monitoring patients on ketogenic diets and patients with diabetes.

(b) *Classification*. Class I (general controls). The device is exempt from the premarket notification procedures in subpart E of part 807 of this chapter subject to § 862.9.

[52 FR 16122, May 1, 1987, as amended at 65 FR 2307, Jan. 14, 2000]

### § 862.1440 Lactate dehydrogenase test system.

(a) *Identification*. A lactate dehydrogenase test system is a device intended to measure the activity of the enzyme lactate dehydrogenase in serum. Lactate dehydrogenase measurements are used in the diagnosis and treatment of liver diseases such as acute viral hepatitis, cirrhosis, and metastatic carcinoma of the liver, cardiac diseases such as myocardial infarction, and tumors of the lung or kidneys.

(b) *Classification*. Class II (special controls). The device is exempt from the premarket notification procedures in subpart E of part 807 of this chapter subject to § 862.9.

[52 FR 16122, May 1, 1987, as amended at 63 FR 59225, Nov. 3, 1998]

**§ 862.1445 Lactate dehydrogenase isoenzymes test system.**

(a) *Identification.* A lactate dehydrogenase isoenzymes test system is a device intended to measure the activity of lactate dehydrogenase isoenzymes (a group of enzymes with similar biological activity) in serum. Measurements of lactate dehydrogenase isoenzymes are used in the diagnosis and treatment of liver diseases, such as viral hepatitis, and myocardial infarction.

(b) *Classification.* Class II (special controls). The device is exempt from the premarket notification procedures in subpart E of part 807 of this chapter subject to the limitations in § 862.9.

[52 FR 16122, May 1, 1987, as amended at 84 FR 71796, Dec. 30, 2019]

**§ 862.1450 Lactic acid test system.**

(a) *Identification.* A lactic acid test system is a device intended to measure lactic acid in whole blood and plasma. Lactic acid measurements that evaluate the acid-base status are used in the diagnosis and treatment of lactic acidosis (abnormally high acidity of the blood).

(b) *Classification.* Class I (general controls). The device is exempt from the premarket notification procedures in subpart E of part 807 of this chapter subject to § 862.9.

[52 FR 16122, May 1, 1987, as amended at 65 FR 2307, Jan. 14, 2000]

**§ 862.1455 Lecithin/sphingomyelin ratio in amniotic fluid test system.**

(a) *Identification.* A lecithin/sphingomyelin ratio in amniotic fluid test system is a device intended to measure the lecithin/sphingomyelin ratio in amniotic fluid. Lecithin and sphingomyelin are phospholipids (fats or fat-like substances containing phosphorus). Measurements of the lecithin/sphingomyelin ratio in amniotic fluid are used in evaluating fetal maturity.

(b) *Classification.* Class II.

**§ 862.1460 Leucine aminopeptidase test system.**

(a) *Identification.* A leucine aminopeptidase test system is a device intended to measure the activity of the enzyme leucine aminopeptidase in serum, plasma, and urine. Leucine

aminopeptidase measurements are used in the diagnosis and treatment of liver diseases such as viral hepatitis and obstructive jaundice.

(b) *Classification.* Class I (general controls). The device is exempt from the premarket notification procedures in subpart E of part 807 of this chapter subject to § 862.9.

[52 FR 16122, May 1, 1987, as amended at 65 FR 2307, Jan. 14, 2000]

**§ 862.1465 Lipase test system.**

(a) *Identification.* A lipase test system is a device intended to measure the activity of the enzymes lipase in serum. Lipase measurements are used in diagnosis and treatment of diseases of the pancreas such as acute pancreatitis and obstruction of the pancreatic duct.

(b) *Classification.* Class I (general controls). The device is exempt from the premarket notification procedures in subpart E of part 807 of this chapter subject to § 862.9.

[52 FR 16122, May 1, 1987, as amended at 65 FR 2307, Jan. 14, 2000]

**§ 862.1470 Lipid (total) test system.**

(a) *Identification.* A lipid (total) test system is a device intended to measure total lipids (fats or fat-like substances) in serum and plasma. Lipid (total) measurements are used in the diagnosis and treatment of various diseases involving lipid metabolism and atherosclerosis.

(b) *Classification.* Class I (general controls). The device is exempt from the premarket notification procedures in subpart E of part 807 of this chapter subject to the limitations in § 862.9.

[52 FR 16122, May 1, 1987, as amended at 53 FR 21449, June 8, 1988; 66 FR 38788, July 25, 2001]

**§ 862.1475 Lipoprotein test system.**

(a) *Identification.* A lipoprotein test system is a device intended to measure lipoprotein in serum and plasma. Lipoprotein measurements are used in the diagnosis and treatment of lipid disorders (such as diabetes mellitus), atherosclerosis, and various liver and renal diseases.

(b) *Classification.* Class I (general controls). The device is exempt from the premarket notification procedures in

**§ 862.1485**

subpart E of part 807 of this chapter subject to § 862.9.

[52 FR 16122, May 1, 1987, as amended at 65 FR 2307, Jan. 14, 2000]

**§ 862.1485 Luteinizing hormone test system.**

(a) *Identification.* A luteinizing hormone test system is a device intended to measure luteinizing hormone in serum and urine. Luteinizing hormone measurements are used in the diagnosis and treatment of gonadal dysfunction.

(b) *Classification.* Class I (general controls). The device is exempt from the premarket notification procedures in subpart E of part 807 of this chapter subject to § 862.9.

[52 FR 16122, May 1, 1987, as amended at 65 FR 2307, Jan. 14, 2000]

**§ 862.1490 Lysozyme (muramidase) test system.**

(a) *Identification.* A lysozyme (muramidase) test system is a device intended to measure the activity of the bacteriolytic enzyme lysozyme (muramidase) in serum, plasma, leukocytes, and urine. Lysozyme measurements are used in the diagnosis and treatment of monocytic leukemia and kidney disease.

(b) *Classification.* Class I (general controls). The device is exempt from the premarket notification procedures in subpart E of part 807 of this chapter subject to the limitations in § 862.9.

[52 FR 16122, May 1, 1987, as amended at 53 FR 21449, June 8, 1988; 66 FR 38788, July 25, 2001]

**§ 862.1495 Magnesium test system.**

(a) *Identification.* A magnesium test system is a device intended to measure magnesium levels in serum and plasma. Magnesium measurements are used in the diagnosis and treatment of hypomagnesemia (abnormally low plasma levels of magnesium) and hypermagnesemia (abnormally high plasma levels of magnesium).

(b) *Classification.* Class I.

**§ 862.1500 Malic dehydrogenase test system.**

(a) *Identification.* A malic dehydrogenase test system is a device that is

**21 CFR Ch. I (4–1–20 Edition)**

intended to measure the activity of the enzyme malic dehydrogenase in serum and plasma. Malic dehydrogenase measurements are used in the diagnosis and treatment of muscle and liver diseases, myocardial infarctions, cancer, and blood disorders such as myelogenous (produced in the bone marrow) leukemia.

(b) *Classification.* Class I (general controls). The device is exempt from the premarket notification procedures in subpart E of part 807 of this chapter subject to § 862.9.

[52 FR 16122, May 1, 1987, as amended at 65 FR 2307, Jan. 14, 2000]

**§ 862.1505 Mucopolysaccharides (non-quantitative) test system.**

(a) *Identification.* A mucopolysaccharides (nonquantitative) test system is a device intended to measure the levels of mucopolysaccharides in urine. Mucopolysaccharide measurements in urine are used in the diagnosis and treatment of various inheritable disorders that affect bone and connective tissues, such as Hurler's, Hunter's, Sanfilippo's, Scheie's Morquio's and Maroteaux-Lamy syndromes.

(b) *Classification.* Class I (general controls). The device is exempt from the premarket notification procedures in subpart E of part 807 of this chapter subject to § 862.9.

[52 FR 16122, May 1, 1987, as amended at 65 FR 2307, Jan. 14, 2000]

**§ 862.1509 Methylmalonic acid (non-quantitative) test system.**

(a) *Identification.* A methylmalonic acid (nonquantitative) test system is a device intended to identify methylmalonic acid in urine. The identification of methylmalonic acid in urine is used in the diagnosis and treatment of methylmalonic aciduria, a heritable metabolic disorder which, if untreated, may cause mental retardation.

(b) *Classification.* Class II (special controls). The device is exempt from the premarket notification procedures in subpart E of part 807 of this chapter subject to the limitations in § 862.9.

[52 FR 16122, May 1, 1987, as amended at 84 FR 71796, Dec. 30, 2019]

**§ 862.1510 Nitrite (nonquantitative) test system.**

(a) *Identification.* A nitrite (non-quantitative) test system is a device intended to identify nitrite in urine. Nitrite identification is used in the diagnosis and treatment of urinary tract infection of bacterial origin.

(b) *Classification.* Class I (general controls). The device is exempt from the premarket notification procedures in subpart E of part 807 of this chapter subject to § 862.9.

[52 FR 16122, May 1, 1987, as amended at 65 FR 2307, Jan. 14, 2000]

**§ 862.1515 Nitrogen (amino-nitrogen) test system.**

(a) *Identification.* A nitrogen (amino-nitrogen) test system is a device intended to measure amino acid nitrogen levels in serum, plasma, and urine. Nitrogen (amino-nitrogen) measurements are used in the diagnosis and treatment of certain forms of severe liver disease and renal disorders.

(b) *Classification.* Class I (general controls). The device is exempt from the premarket notification procedures in subpart E of part 807 of this chapter subject to the limitations in § 862.9.

[52 FR 16122, May 1, 1987, as amended at 53 FR 21449, June 8, 1988; 66 FR 38788, July 25, 2001]

**§ 862.1520 5'-Nucleotidase test system.**

(a) *Identification.* A 5'-nucleotidase test system is a device intended to measure the activity of the enzyme 5'-nucleotidase in serum and plasma. Measurements of 5'-nucleotidase are used in the diagnosis and treatment of liver diseases and in the differentiations between liver and bone diseases in the presence of elevated serum alkaline phosphatase activity.

(b) *Classification.* Class I (general controls). The device is exempt from the premarket notification procedures in subpart E of part 807 of this chapter subject to § 862.9.

[52 FR 16122, May 1, 1987, as amended at 65 FR 2307, Jan. 14, 2000]

**§ 862.1530 Plasma oncometry test system.**

(a) *Identification.* A plasma oncometry test system is a device in-

tended to measure plasma oncotic pressure. Plasma oncotic pressure is that portion of the total fluid pressure contributed by proteins and other molecules too large to pass through a specified membrane. Measurements of plasma oncotic pressure are used in the diagnosis and treatment of dehydration and circulatory disorders related to low serum protein levels and increased capillary permeability, such as edema and shock.

(b) *Classification.* Class I (general controls). The device is exempt from the premarket notification procedures in subpart E of part 807 of this chapter subject to § 862.9.

[52 FR 16122, May 1, 1987, as amended at 65 FR 2307, Jan. 14, 2000]

**§ 862.1535 Ornithine carbamyl transferase test system.**

(a) *Identification.* An ornithine carbamyl transferase test system is a device intended to measure the activity of the enzyme ornithine carbamyl transferase (OCT) in serum. Ornithine carbamyl transferase measurements are used in the diagnosis and treatment of liver diseases, such as infectious hepatitis, acute cholecystitis (inflammation of the gall bladder), cirrhosis, and liver metastases.

(b) *Classification.* Class I (general controls). The device is exempt from the premarket notification procedures in subpart E of part 807 of this chapter subject to § 862.9.

[52 FR 16122, May 1, 1987, as amended at 65 FR 2307, Jan. 14, 2000]

**§ 862.1540 Osmolality test system.**

(a) *Identification.* An osmolality test system is a device intended to measure ionic and nonionic solute concentration in body fluids, such as serum and urine. Osmolality measurement is used as an adjunct to other tests in the evaluation of a variety of diseases, including kidney diseases (e.g., chronic progressive renal failure), diabetes insipidus, other endocrine and metabolic disorders, and fluid imbalances.

(b) *Classification.* Class I (general controls). The device is exempt from the premarket notification procedures in

## § 862.1542

subpart E of part 807 of this chapter subject to § 862.9.

[52 FR 16122, May 1, 1987, as amended at 65 FR 2307, Jan. 14, 2000]

### § 862.1542 Oxalate test system.

(a) *Identification.* An oxalate test system is a device intended to measure the concentration of oxalate in urine. Measurements of oxalate are used to aid in the diagnosis or treatment of urinary stones or certain other metabolic disorders.

(b) *Classification.* Class I (general controls). The device is exempt from the premarket notification procedures in subpart E of part 807 of this chapter subject to § 862.9.

[52 FR 16122, May 1, 1987, as amended at 65 FR 2307, Jan. 14, 2000]

### § 862.1545 Parathyroid hormone test system.

(a) *Identification.* A parathyroid hormone test system is a device intended to measure the levels of parathyroid hormone in serum and plasma. Measurements of parathyroid hormone levels are used in the differential diagnosis of hypercalcemia (abnormally high levels of calcium in the blood) and hypocalcemia (abnormally low levels of calcium in the blood) resulting from disorders of calcium metabolism.

(b) *Classification.* Class II.

### § 862.1550 Urinary pH (nonquantitative) test system.

(a) *Identification.* A urinary pH (nonquantitative) test system is a device intended to estimate the pH of urine. Estimations of pH are used to evaluate the acidity or alkalinity of urine as it relates to numerous renal and metabolic disorders and in the monitoring of patients with certain diets.

(b) *Classification.* Class I (general controls). The device is exempt from the premarket notification procedures in subpart E of part 807 of this chapter subject to § 862.9.

[52 FR 16122, May 1, 1987, as amended at 65 FR 2307, Jan. 14, 2000]

### § 862.1555 Phenylalanine test system.

(a) *Identification.* A phenylalanine test system is a device intended to measure free phenylalanine (an amino

## 21 CFR Ch. I (4–1–20 Edition)

acid) in serum, plasma, and urine. Measurements of phenylalanine are used in the diagnosis and treatment of congenital phenylketonuria which, if untreated, may cause mental retardation.

(b) *Classification.* Class II.

### § 862.1560 Urinary phenylketones (nonquantitative) test system.

(a) *Identification.* A urinary phenylketones (nonquantitative) test system is a device intended to identify phenylketones (such as phenylpyruvic acid) in urine. The identification of urinary phenylketones is used in the diagnosis and treatment of congenital phenylketonuria which, if untreated, may cause mental retardation.

(b) *Classification.* Class I (general controls). The device is exempt from the premarket notification procedures in subpart E of part 807 of this chapter subject to § 862.9.

[52 FR 16122, May 1, 1987, as amended at 65 FR 2307, Jan. 14, 2000]

### § 862.1565 6-Phosphogluconate dehydrogenase test system.

(a) *Identification.* A 6-phosphogluconate dehydrogenase test system is a device intended to measure the activity of the enzyme 6-phosphogluconate dehydrogenase (6 PGD) in serum and erythrocytes. Measurements of 6-phosphogluconate dehydrogenase are used in the diagnosis and treatment of certain liver diseases (such as hepatitis) and anemias.

(b) *Classification.* Class I (general controls). The device is exempt from the premarket notification procedures in subpart E of part 807 of this chapter subject to the limitations in § 862.9.

[52 FR 16122, May 1, 1987, as amended at 53 FR 21449, June 8, 1988; 66 FR 38788, July 25, 2001]

### § 862.1570 Phosphohexose isomerase test system.

(a) *Identification.* A phosphohexose isomerase test system is a device intended to measure the activity of the enzyme phosphohexose isomerase in serum. Measurements of phosphohexose isomerase are used in the diagnosis and treatment of muscle diseases such as muscular dystrophy,

liver diseases such as hepatitis or cirrhosis, and metastatic carcinoma.

(b) *Classification.* Class I (general controls). The device is exempt from the premarket notification procedures in subpart E of part 807 of this chapter subject to § 862.9.

[52 FR 16122, May 1, 1987, as amended at 65 FR 2307, Jan. 14, 2000]

**§ 862.1575 Phospholipid test system.**

(a) *Identification.* A phospholipid test system is a device intended to measure phospholipids in serum and plasma. Measurements of phospholipids are used in the diagnosis and treatment of disorders involving lipid (fat) metabolism.

(b) *Classification.* Class I (general controls). The device is exempt from the premarket notification procedures in subpart E of part 807 of this chapter subject to the limitations in § 862.9.

[52 FR 16122, May 1, 1987, as amended at 53 FR 21449, June 8, 1988; 66 FR 38788, July 25, 2001]

**§ 862.1580 Phosphorus (inorganic) test system.**

(a) *Identification.* A phosphorus (inorganic) test system is a device intended to measure inorganic phosphorus in serum, plasma, and urine. Measurements of phosphorus (inorganic) are used in the diagnosis and treatment of various disorders, including parathyroid gland and kidney diseases, and vitamin D imbalance.

(b) *Classification.* Class I (general controls). The device is exempt from the premarket notification procedures in subpart E of part 807 of this chapter subject to the limitations in § 862.9.

[52 FR 16122, May 1, 1987, as amended at 84 FR 71796, Dec. 30, 2019]

**§ 862.1585 Human placental lactogen test system.**

(a) *Identification.* A human placental lactogen test system is a device intended to measure the hormone human placental lactogen (HPL), (also known as human chorionic somatomammotrophin (HCS)), in maternal serum and maternal plasma. Measurements of human placental lactogen are used in the diagnosis and clinical management of high-risk preg-

nancies involving fetal distress associated with placental insufficiency. Measurements of HPL are also used in pregnancies complicated by hypertension, proteinuria, edema, post-maturity, placental insufficiency, or possible miscarriage.

(b) *Classification.* Class II.

**§ 862.1590 Porphobilinogen test system.**

(a) *Identification.* A porphobilinogen test system is a device intended to measure porphobilinogen (one of the derivatives of hemoglobin which can make the urine a red color) in urine. Measurements obtained by this device are used in the diagnosis and treatment of porphyrias (primarily inherited diseases associated with disturbed porphyrine metabolism), lead poisoning, and other diseases characterized by alterations in the heme pathway.

(b) *Classification.* Class I (general controls). The device is exempt from the premarket notification procedures in subpart E of part 807 of this chapter subject to § 862.9.

[52 FR 16122, May 1, 1987, as amended at 65 FR 2307, Jan. 14, 2000]

**§ 862.1595 Porphyrins test system.**

(a) *Identification.* A porphyrins test system is a device intended to measure porphyrins (compounds formed during the biosynthesis of heme, a constituent of hemoglobin, and related compounds) in urine and feces. Measurements obtained by this device are used in the diagnosis and treatment of lead poisoning, porphyrias (primarily inherited diseases associated with disturbed porphyrin metabolism), and other diseases characterized by alterations in the heme pathway.

(b) *Classification.* Class I (general controls). The device is exempt from the premarket notification procedures in subpart E of part 807 of this chapter subject to § 862.9.

[52 FR 16122, May 1, 1987, as amended at 65 FR 2308, Jan. 14, 2000]

**§ 862.1600 Potassium test system.**

(a) *Identification.* A potassium test system is a device intended to measure potassium in serum, plasma, and urine.

## § 862.1605

Measurements obtained by this device are used to monitor electrolyte balance in the diagnosis and treatment of diseases conditions characterized by low or high blood potassium levels.

(b) *Classification.* Class II.

## § 862.1605 Pregnanediol test system.

(a) *Identification.* A pregnanediol test system is a device intended to measure pregnanediol (a major urinary metabolic product of progesterone) in urine. Measurements obtained by this device are used in the diagnosis and treatment of disorders of the ovaries or placenta.

(b) *Classification.* Class I (general controls). The device is exempt from the premarket notification procedures in subpart E of part 807 of this chapter subject to § 862.9.

[52 FR 16122, May 1, 1987, as amended at 65 FR 2308, Jan. 14, 2000]

## § 862.1610 Pregnanetriol test system.

(a) *Identification.* A pregnanetriol test system is a device intended to measure pregnanetriol (a precursor in the biosynthesis of the adrenal hormone cortisol) in urine. Measurements obtained by this device are used in the diagnosis and treatment of congenital adrenal hyperplasia (congenital enlargement of the adrenal gland).

(b) *Classification.* Class I (general controls). The device is exempt from the premarket notification procedures in subpart E of part 807 of this chapter subject to § 862.9.

[52 FR 16122, May 1, 1987, as amended at 65 FR 2308, Jan. 14, 2000]

## § 862.1615 Pregnenolone test system.

(a) *Identification.* A pregnenolone test system is a device intended to measure pregnenolone (a precursor in the biosynthesis of the adrenal hormone cortisol and adrenal androgen) in serum and plasma. Measurements obtained by this device are used in the diagnosis and treatment of diseases of the adrenal cortex or the gonads.

(b) *Classification.* Class I (general controls). The device is exempt from the premarket notification procedures in

## 21 CFR Ch. I (4–1–20 Edition)

subpart E of part 807 of this chapter subject to § 862.9.

[52 FR 16122, May 1, 1987, as amended at 65 FR 2308, Jan. 14, 2000]

## § 862.1620 Progesterone test system.

(a) *Identification.* A progesterone test system is a device intended to measure progesterone (a female hormone) in serum and plasma. Measurements obtained by this device are used in the diagnosis and treatment of disorders of the ovaries or placenta.

(b) *Classification.* Class I (general controls). The device is exempt from the premarket notification procedures in subpart E of part 807 of this chapter subject to § 862.9.

[52 FR 16122, May 1, 1987, as amended at 65 FR 2308, Jan. 14, 2000]

## § 862.1625 Prolactin (lactogen) test system.

(a) *Identification.* A prolactin (lactogen) test system is a device intended to measure the anterior pituitary polypeptide hormone prolactin in serum and plasma. Measurements obtained by this device are used in the diagnosis and treatment of disorders of the anterior pituitary gland or of the hypothalamus portion of the brain.

(b) *Classification.* Class I (general controls). The device is exempt from the premarket notification procedures in subpart E of part 807 of this chapter subject to § 862.9.

[52 FR 16122, May 1, 1987, as amended at 65 FR 2308, Jan. 14, 2000]

## § 862.1630 Protein (fractionation) test system.

(a) *Identification.* A protein (fractionation) test system is a device intended to measure protein fractions in blood, urine, cerebrospinal fluid, and other body fluids. Protein fractionations are used as an aid in recognizing abnormal proteins in body fluids and genetic variants of proteins produced in diseases with tissue destruction.

(b) *Classification.* Class I (general controls). The device is exempt from the premarket notification procedures in subpart E of part 807 of this chapter subject to § 862.9.

[52 FR 16122, May 1, 1987, as amended at 65 FR 2308, Jan. 14, 2000]



**§ 862.1635 Total protein test system.**

(a) *Identification.* A total protein test system is a device intended to measure total protein(s) in serum or plasma. Measurements obtained by this device are used in the diagnosis and treatment of a variety of diseases involving the liver, kidney, or bone marrow as well as other metabolic or nutritional disorders.

(b) *Classification.* Class II (special controls). The device is exempt from the premarket notification procedures in subpart E of part 807 of this chapter subject to § 862.9.

[52 FR 16122, May 1, 1987, as amended at 63 FR 59225, Nov. 3, 1998]

**§ 862.1640 Protein-bound iodine test system.**

(a) *Identification.* A protein-bound iodine test system is a device intended to measure protein-bound iodine in serum. Measurements of protein-bound iodine obtained by this device are used in the diagnosis and treatment of thyroid disorders.

(b) *Classification.* Class I (general controls). The device is exempt from the premarket notification procedures in subpart E of part 807 of this chapter subject to the limitations in § 862.9.

[52 FR 16122, May 1, 1987, as amended at 53 FR 21449, June 8, 1988; 66 FR 38788, July 25, 2001]

**§ 862.1645 Urinary protein or albumin (nonquantitative) test system.**

(a) *Identification.* A urinary protein or albumin (nonquantitative) test system is a device intended to identify proteins or albumin in urine. Identification of urinary protein or albumin (nonquantitative) is used in the diagnosis and treatment of disease conditions such as renal or heart diseases or thyroid disorders, which are characterized by proteinuria or albuminuria.

(b) *Classification.* Class I (general controls). The device is exempt from the premarket notification procedures in subpart E of part 807 of this chapter subject to § 862.9.

[52 FR 16122, May 1, 1987, as amended at 65 FR 2308, Jan. 14, 2000]

**§ 862.1650 Pyruvate kinase test system.**

(a) *Identification.* A pyruvate kinase test system is a device intended to measure the activity of the enzyme pyruvate kinase in erythrocytes (red blood cells). Measurements obtained by this device are used in the diagnosis and treatment of various inherited anemias due to pyruvate kinase deficiency or of acute leukemias.

(b) *Classification.* Class I (general controls). The device is exempt from the premarket notification procedures in subpart E of part 807 of this chapter subject to § 862.9.

[52 FR 16122, May 1, 1987, as amended at 65 FR 2308, Jan. 14, 2000]

**§ 862.1655 Pyruvic acid test system.**

(a) *Identification.* A pyruvic acid test system is a device intended to measure pyruvic acid (an intermediate compound in the metabolism of carbohydrate) in plasma. Measurements obtained by this device are used in the evaluation of electrolyte metabolism and in the diagnosis and treatment of acid-base and electrolyte disturbances or anoxia (the reduction of oxygen in body tissues).

(b) *Classification.* Class I (general controls). The device is exempt from the premarket notification procedures in subpart E of part 807 of this chapter subject to § 862.9.

[52 FR 16122, May 1, 1987, as amended at 65 FR 2308, Jan. 14, 2000]

**§ 862.1660 Quality control material (assayed and unassayed).**

(a) *Identification.* A quality control material (assayed and unassayed) for clinical chemistry is a device intended for medical purposes for use in a test system to estimate test precision and to detect systematic analytical deviations that may arise from reagent or analytical instrument variation. A quality control material (assayed and unassayed) may be used for proficiency testing in interlaboratory surveys. This generic type of device includes controls (assayed and unassayed) for blood gases, electrolytes, enzymes, multianalytes (all kinds), single (specified) analytes, or urinalysis controls.

(b) *Classification.* Class I (general controls). Except when intended for use in

**§ 862.1665**

donor screening tests, quality control materials (assayed and unassayed) are exempt from the premarket notification procedures in subpart E of part 807 of this chapter subject to the limitations in § 862.9.

[52 FR 16122, May 1, 1987, as amended at 65 FR 2308, Jan. 14, 2000, 84 FR 71796, Dec. 30, 2019]

**§ 862.1665 Sodium test system.**

(a) *Identification.* A sodium test system is a device intended to measure sodium in serum, plasma, and urine. Measurements obtained by this device are used in the diagnosis and treatment of aldosteronism (excessive secretion of the hormone aldosterone), diabetes insipidus (chronic excretion of large amounts of dilute urine, accompanied by extreme thirst), adrenal hypertension, Addison's disease (caused by destruction of the adrenal glands), dehydration, inappropriate antidiuretic hormone secretion, or other diseases involving electrolyte imbalance.

(b) *Classification.* Class II.

**§ 862.1670 Sorbitol dehydrogenase test system.**

(a) *Identification.* A sorbitol dehydrogenase test system is a device intended to measure the activity of the enzyme sorbitol dehydrogenase in serum. Measurements obtained by this device are used in the diagnosis and treatment of liver disorders such as cirrhosis or acute hepatitis.

(b) *Classification.* Class I (general controls). The device is exempt from the premarket notification procedures in subpart E of part 807 of this chapter subject to the limitations in § 862.9.

[52 FR 16122, May 1, 1987, as amended at 53 FR 21449, June 8, 1988; 66 FR 38788, July 25, 2001]

**§ 862.1675 Blood specimen collection device.**

(a) *Identification.* A blood specimen collection device is a device intended for medical purposes to collect and to handle blood specimens and to separate serum from nonserum (cellular) components prior to further testing. This generic type device may include blood collection tubes, vials, systems, serum separators, blood collection trays, or vacuum sample tubes.

**21 CFR Ch. I (4–1–20 Edition)**

(b) *Classification.* Class II.

**§ 862.1678 Tacrolimus test system.**

(a) *Identification.* A tacrolimus test system is a device intended to quantitatively determine tacrolimus concentrations as an aid in the management of transplant patients receiving therapy with this drug. This generic type of device includes immunoassays and chromatographic assays for tacrolimus.

(b) *Classification.* Class II (special controls). The special control is “Class II Special Controls Guidance Document: Cyclosporine and Tacrolimus Assays; Guidance for Industry and FDA.” See § 862.1(d) for the availability of this guidance document.

[67 FR 58329, Sept. 16, 2002]

**§ 862.1680 Testosterone test system.**

(a) *Identification.* A testosterone test system is a device intended to measure testosterone (a male sex hormone) in serum, plasma, and urine. Measurement of testosterone are used in the diagnosis and treatment of disorders involving the male sex hormones (androgens), including primary and secondary hypogonadism, delayed or precocious puberty, impotence in males and, in females hirsutism (excessive hair) and virilization (masculinization) due to tumors, polycystic ovaries, and adrenogenital syndromes.

(b) *Classification.* Class I.

[52 FR 16122, May 1, 1987; 53 FR 11645, Apr. 8, 1988]

**§ 862.1685 Thyroxine-binding globulin test system.**

(a) *Identification.* A thyroxine-binding globulin test system is a device intended to measure thyroxine (thyroid)-binding globulin (TBG), a plasma protein which binds thyroxine, in serum and plasma. Measurements obtained by this device are used in the diagnosis and treatment of thyroid diseases.

(b) *Classification.* Class II (special controls). The device is exempt from the premarket notification procedures in subpart E of part 807 of this chapter subject to the limitations in § 862.9.

[52 FR 16122, May 1, 1987, as amended at 84 FR 71797, Dec. 30, 2019]

**§ 862.1690 Thyroid stimulating hormone test system.**

(a) *Identification.* A thyroid stimulating hormone test system is a device intended to measure thyroid stimulating hormone, also known as thyrotrophin and thyrotrophic hormone, in serum and plasma. Measurements of thyroid stimulating hormone produced by the anterior pituitary are used in the diagnosis of thyroid or pituitary disorders.

(b) *Classification.* Class II.

**§ 862.1695 Free thyroxine test system.**

(a) *Identification.* A free thyroxine test system is a device intended to measure free (not protein bound) thyroxine (thyroid hormone) in serum or plasma. Levels of free thyroxine in plasma are thought to reflect the amount of thyroxine hormone available to the cells and may therefore determine the clinical metabolic status of thyroxine. Measurements obtained by this device are used in the diagnosis and treatment of thyroid diseases.

(b) *Classification.* Class II.

**§ 862.1700 Total thyroxine test system.**

(a) *Identification.* A total thyroxine test system is a device intended to measure total (free and protein bound) thyroxine (thyroid hormone) in serum and plasma. Measurements obtained by this device are used in the diagnosis and treatment of thyroid diseases.

(b) *Classification.* Class II (special controls). The device is exempt from the premarket notification procedures in subpart E of part 807 of this chapter subject to the limitations in § 862.9.

[52 FR 16122, May 1, 1987, as amended at 84 FR 71797, Dec. 30, 2019]

**§ 862.1705 Triglyceride test system.**

(a) *Identification.* A triglyceride test system is a device intended to measure triglyceride (neutral fat) in serum and plasma. Measurements obtained by this device are used in the diagnosis and treatment of patients with diabetes mellitus, nephrosis, liver obstruction, other diseases involving lipid metabolism, or various endocrine disorders.

(b) *Classification.* Class I (general controls). The device is exempt from the premarket notification procedures in

subpart E of part 807 of this chapter subject to § 862.9.

[52 FR 16122, May 1, 1987, as amended at 65 FR 2308, Jan. 14, 2000]

**§ 862.1710 Total triiodothyronine test system.**

(a) *Identification.* A total triiodothyronine test system is a device intended to measure the hormone triiodothyronine in serum and plasma. Measurements obtained by this device are used in the diagnosis and treatment of thyroid diseases such as hyperthyroidism.

(b) *Classification.* Class II. This device is exempt from the premarket notification procedures in subpart E of part 807 of this chapter subject to the limitations in § 862.9.

[52 FR 16122, May 1, 1987, as amended at 65 FR 62286, Oct. 18, 2000]

**§ 862.1715 Triiodothyronine uptake test system.**

(a) *Identification.* A triiodothyronine uptake test system is a device intended to measure the total amount of binding sites available for binding thyroid hormone on the thyroxine-binding proteins, thyroid-binding globulin, thyroxine-binding prealbumin, and albumin of serum and plasma. The device provides an indirect measurement of thyroxine levels in serum and plasma. Measurements of triiodothyronine uptake are used in the diagnosis and treatment of thyroid disorders.

(b) *Classification.* Class II. The device is exempt from the premarket notification procedures in subpart E of part 807 of this chapter subject to the limitations in § 862.9.

[52 FR 16122, May 1, 1987, as amended at 64 FR 1124, Jan. 8, 1999]

**§ 862.1720 Triose phosphate isomerase test system.**

(a) *Identification.* A triose phosphate isomerase test system is a device intended to measure the activity of the enzyme triose phosphate isomerase in erythrocytes (red blood cells). Triose phosphate isomerase is an enzyme important in glycolysis (the energy-yielding conversion of glucose to lactic acid

## § 862.1725

in various tissues). Measurements obtained by this device are used in the diagnosis and treatment of congenital triose phosphate isomerase enzyme deficiency, which causes a type of hemolytic anemia.

(b) *Classification*. Class I (general controls). The device is exempt from the premarket notification procedures in subpart E of part 807 subject to the limitations in § 862.9.

[52 FR 16122, May 1, 1987, as amended at 53 FR 21449, June 8, 1988; 66 FR 38788, July 25, 2001]

## § 862.1725 Trypsin test system.

(a) *Identification*. A trypsin test system is a device intended to measure the activity of trypsin (a pancreatic enzyme important in digestion for the breakdown of proteins) in blood and other body fluids and in feces. Measurements obtained by this device are used in the diagnosis and treatment of pancreatic disease.

(b) *Classification*. Class I (general controls). The device is exempt from the premarket notification procedures in subpart E of part 807 of this chapter subject to § 862.9.

[52 FR 16122, May 1, 1987, as amended at 65 FR 2308, Jan. 14, 2000]

## § 862.1730 Free tyrosine test system.

(a) *Identification*. A free tyrosine test system is a device intended to measure free tyrosine (an amino acid) in serum and urine. Measurements obtained by this device are used in the diagnosis and treatment of diseases such as congenital tyrosinemia (a disease that can cause liver/kidney disorders) and as an adjunct to the measurement of phenylalanine in detecting congenital phenylketonuria (a disease that can cause brain damage).

(b) *Classification*. Class I.

## § 862.1770 Urea nitrogen test system.

(a) *Identification*. A urea nitrogen test system is a device intended to measure urea nitrogen (an end-product of nitrogen metabolism) in whole blood, serum, plasma, and urine. Measurements obtained by this device are used in the diagnosis and treatment of certain renal and metabolic diseases.

(b) *Classification*. Class II.

## 21 CFR Ch. I (4–1–20 Edition)

## § 862.1775 Uric acid test system.

(a) *Identification*. A uric acid test system is a device intended to measure uric acid in serum, plasma, and urine. Measurements obtained by this device are used in the diagnosis and treatment of numerous renal and metabolic disorders, including renal failure, gout, leukemia, psoriasis, starvation or other wasting conditions, and of patients receiving cytotoxic drugs.

(b) *Classification*. Class I (general controls). The device is exempt from the premarket notification procedures in subpart E of part 807 of this chapter subject to the limitations in § 862.9.

[52 FR 16122, May 1, 1987, as amended at 84 FR 71797, Dec. 30, 2019]

## § 862.1780 Urinary calculi (stones) test system.

(a) *Identification*. A urinary calculi (stones) test system is a device intended for the analysis of urinary calculi. Analysis of urinary calculi is used in the diagnosis and treatment of calculi of the urinary tract.

(b) *Classification*. Class I (general controls). The device is exempt from the premarket notification procedures in subpart E of part 807 of this chapter subject to § 862.9.

[52 FR 16122, May 1, 1987, as amended at 65 FR 2308, Jan. 14, 2000]

## § 862.1785 Urinary urobilinogen (non-quantitative) test system.

(a) *Identification*. A urinary urobilinogen (nonquantitative) test system is a device intended to detect and estimate urobilinogen (a bile pigment degradation product of red cell hemoglobin) in urine. Estimations obtained by this device are used in the diagnosis and treatment of liver diseases and hemolytic (red cells) disorders.

(b) *Classification*. Class I (general controls). The device is exempt from the premarket notification procedures in subpart E of part 807 of this chapter subject to § 862.9.

[52 FR 16122, May 1, 1987, as amended at 65 FR 2308, Jan. 14, 2000]

## § 862.1790 Uroporphyrin test system.

(a) *Identification*. A uroporphyrin test system is a device intended to measure uroporphyrin in urine. Measurements

obtained by this device are used in the diagnosis and treatment of porphyrias (primarily inherited diseases associated with disturbed porphyrin metabolism), lead poisoning, and other diseases characterized by alterations in the heme pathway.

(b) *Classification*. Class I (general controls). The device is exempt from the premarket notification procedures in subpart E of part 807 of this chapter subject to § 862.9.

[52 FR 16122, May 1, 1987, as amended at 65 FR 2308, Jan. 14, 2000]

**§ 862.1795 Vanilmandelic acid test system.**

(a) *Identification*. A vanilmandelic acid test system is a device intended to measure vanilmandelic acid in urine. Measurements of vanilmandelic acid obtained by this device are used in the diagnosis and treatment of neuroblastoma, pheochromocytoma, and certain hypertensive conditions.

(b) *Classification*. Class I (general controls). The device is exempt from the premarket notification procedures in subpart E of part 807 of this chapter subject to § 862.9.

[52 FR 16122, May 1, 1987, as amended at 65 FR 2308, Jan. 14, 2000]

**§ 862.1805 Vitamin A test system.**

(a) *Identification*. A vitamin A test system is a device intended to measure vitamin A in serum or plasma. Measurements obtained by this device are used in the diagnosis and treatment of vitamin A deficiency conditions, including night blindness, or skin, eye, or intestinal disorders.

(b) *Classification*. Class I (general controls). The device is exempt from the premarket notification procedures in subpart E of part 807 of this chapter subject to § 862.9.

[52 FR 16122, May 1, 1987, as amended at 65 FR 2308, Jan. 14, 2000]

**§ 862.1810 Vitamin B<sub>12</sub> test system.**

(a) *Identification*. A vitamin B<sub>12</sub> test system is a device intended to measure vitamin B<sub>12</sub> in serum, plasma, and urine. Measurements obtained by this device are used in the diagnosis and treatment of anemias of gastrointestinal malabsorption.

(b) *Classification*. Class II.

**§ 862.1815 Vitamin E test system.**

(a) *Identification*. A vitamin E test system is a device intended to measure vitamin E (tocopherol) in serum. Measurements obtained by this device are used in the diagnosis and treatment of infants with vitamin E deficiency syndrome.

(b) *Classification*. Class I (general controls). The device is exempt from the premarket notification procedures in subpart E of part 807 subject to the limitations in § 862.9.

[52 FR 16122, May 1, 1987, as amended at 53 FR 21449, June 8, 1988; 66 FR 38788, July 25, 2001]

**§ 862.1820 Xylose test system.**

(a) *Identification*. A xylose test system is a device intended to measure xylose (a sugar) in serum, plasma, and urine. Measurements obtained by this device are used in the diagnosis and treatment of gastrointestinal malabsorption syndrome (a group of disorders in which there is subnormal absorption of dietary constituents and thus excessive loss from the body of the nonabsorbed substances).

(b) *Classification*. Class I (general controls). The device is exempt from the premarket notification procedures in subpart E of part 807 of this chapter subject to § 862.9.

[52 FR 16122, May 1, 1987, as amended at 65 FR 2308, Jan. 14, 2000]

**§ 862.1825 Vitamin D test system.**

(a) *Identification*. A vitamin D test system is a device intended for use in clinical laboratories for the quantitative determination of 25-hydroxyvitamin D (25-OH-D) and other hydroxylated metabolites of vitamin D in serum or plasma to be used in the assessment of vitamin D sufficiency.

(b) *Classification*. Class II (special controls). Vitamin D test systems must comply with the following special controls:

- (1) Labeling in conformance with 21 CFR 809.10 and
- (2) Compliance with existing standards of the National Committee on Clinical Laboratory Standards.

[63 FR 40366, July 29, 1998]

**§ 862.1840 Total 25-hydroxyvitamin D mass spectrometry test system.**

(a) *Identification.* A total 25-hydroxyvitamin D mass spectrometry test system is a device intended for use in clinical laboratories for the quantitative determination of total 25-hydroxyvitamin D (25-OH-D) in serum or plasma to be used in the assessment of vitamin D sufficiency.

(b) *Classification.* Class II (special controls). The device is exempt from the premarket notification procedures in part 807, subpart E, of this chapter subject to the limitations in § 862.9. The device must comply with the following special controls:

(1) The device must have initial and annual standardization verification by a certifying vitamin D standardization organization deemed acceptable by FDA.

(2) The 21 CFR 809.10(b) compliant labeling must include detailed descriptions of performance testing conducted to evaluate precision, accuracy, linearity, interference, including the following:

(i) Performance testing of device precision must, at a minimum, use intended sample type with Vitamin D concentrations at medically relevant decision points. At least one sample in the precision studies must be an unmodified patient sample. This testing must evaluate repeatability and reproducibility using a protocol from an FDA-recognized standard.

(ii) Performance testing of device accuracy must include a minimum of 115 serum or plasma samples that span the measuring interval of the device and compare results of the new device to results of a reference method or a legally marketed standardized mass spectrometry based vitamin D assay. The results must be described in the 21 CFR 809.10(b)(12) compliant labeling of the device.

(iii) Interference from vitamin D analogs and metabolites including vitamin D2, vitamin D3, 1-hydroxyvitamin D2, 1-hydroxyvitamin D3, 3-Epi-25-Hydroxyvitamin D2, 3-Epi-25-Hydroxyvitamin D3, 1,25-Dihydroxyvitamin D2, 1,25-Dihydroxyvitamin D3, 3-Epi-1,25-Dihydroxyvitamin D2, and 3-Epi-1,25-Dihydroxyvitamin D3, 25, 26-

Dihydroxyvitamin-D3, 24 (R), 25-dihydroxyvitamin-D3, 23 (R), 25-dihydroxyvitamin-D3 must be described in the 21 CFR 809.10(b)(7) compliant labeling of the device.

(3) The 21 CFR 809.10(b) compliant labeling must be supported by a reference range study representative of the performance of the device. The study must be conducted using samples collected from apparently healthy male and female adults at least 21 years of age and older from at least 3 distinct climatic regions within the United States in different weather seasons. The ethnic, racial, and gender background of this study population must be representative of the U.S. population demographics.

(4) The results of the device as provided in the 21 CFR 809.10(b) compliant labeling and any test report generated must be reported as only total 25-hydroxyvitamin D.

[82 FR 51559, Nov. 7, 2017, as amended at 83 FR 25914, June 5, 2018]

**Subpart C—Clinical Laboratory Instruments**

**§ 862.2050 General purpose laboratory equipment labeled or promoted for a specific medical use.**

(a) *Identification.* General purpose laboratory equipment labeled or promoted for a specific medical use is a device that is intended to prepare or examine specimens from the human body and that is labeled or promoted for a specific medical use.

(b) *Classification.* Class I (general controls). The device is identified in paragraph (a) of this section and is exempt from the premarket notification procedures in subpart E of part 807 of this chapter subject to the limitations in § 862.9. The device is also exempt from the current good manufacturing practice requirements of the quality system regulation in part 820 of this chapter, with the exception of § 820.180, with respect to general requirements concerning records, and § 820.198, with respect to complaint files.

[52 FR 16122, May 1, 1987, as amended at 66 FR 38788, July 25, 2001]

**§ 862.2100 Calculator/data processing module for clinical use.**

(a) *Identification.* A calculator/data processing module for clinical use is an electronic device intended to store, retrieve, and process laboratory data.

(b) *Classification.* Class I (general controls). The device is exempt from the premarket notification procedures in subpart E of part 807 of this chapter subject to the limitations in § 862.9.

[52 FR 16122, May 1, 1987, as amended at 53 FR 21449, June 8, 1988; 66 FR 38788, July 25, 2001]

**§ 862.2120 Continuous glucose monitor data management system.**

(a) *Identification.* A continuous glucose monitor data management system is an electronic device intended to acquire, process, and correlate retrospective data from a continuous glucose monitoring device. This device is intended to be used by patients or their healthcare providers when determining therapeutic strategies. A continuous glucose monitor data management system is not a drug dose calculator and does not provide treatment recommendations.

(b) *Classification.* Class I (general controls). The device is exempt from the premarket notification procedures in subpart E of part 807 of this chapter, subject to the limitations in § 862.9.

[84 FR 57817, Oct. 29, 2019]

**§ 862.2140 Centrifugal chemistry analyzer for clinical use.**

(a) *Identification.* A centrifugal chemistry analyzer for clinical use is an automatic device intended to centrifugally mix a sample and a reagent and spectrophotometrically measure concentrations of the sample constituents. This device is intended for use in conjunction with certain materials to measure a variety of analytes.

(b) *Classification.* Class I (general controls). The device is exempt from the premarket notification procedures in subpart E of part 807 of this chapter subject to § 862.9.

[52 FR 16122, May 1, 1987, as amended at 65 FR 2308, Jan. 14, 2000]

**§ 862.2150 Continuous flow sequential multiple chemistry analyzer for clinical use.**

(a) *Identification.* A continuous flow sequential multiple chemistry analyzer for clinical use is a modular analytical instrument intended to simultaneously perform multiple chemical procedures using the principles of automated continuous flow systems. This device is intended for use in conjunction with certain materials to measure a variety of analytes.

(b) *Classification.* Class I (general controls). The device is exempt from the premarket notification procedures in subpart E of part 807 of this chapter subject to § 862.9.

[52 FR 16122, May 1, 1987, as amended at 65 FR 2308, Jan. 14, 2000]

**§ 862.2160 Discrete photometric chemistry analyzer for clinical use.**

(a) *Identification.* A discrete photometric chemistry analyzer for clinical use is a device intended to duplicate manual analytical procedures by performing automatically various steps such as pipetting, preparing filtrates, heating, and measuring color intensity. This device is intended for use in conjunction with certain materials to measure a variety of analytes. Different models of the device incorporate various instrumentation such as micro analysis apparatus, double beam, single, or dual channel photometers, and bichromatic 2-wavelength photometers. Some models of the device may include reagent-containing components that may also serve as reaction units.

(b) *Classification.* Class I (general controls). The device is exempt from the premarket notification procedures in subpart E of part 807 of this chapter subject to § 862.9.

[52 FR 16122, May 1, 1987, as amended at 65 FR 2309, Jan. 14, 2000]

**§ 862.2170 Micro chemistry analyzer for clinical use.**

(a) *Identification.* A micro chemistry analyzer for clinical use is a device intended to duplicate manual analytical procedures by performing automatically various steps such as pipetting,

**§ 862.2230**

preparing filtrates, heating, and measuring color intensity. The distinguishing characteristic of the device is that it requires only micro volume samples obtainable from pediatric patients. This device is intended for use in conjunction with certain materials to measure a variety of analytes.

(b) *Classification*. Class I (general controls). The device is exempt from the premarket notification procedures in subpart E of part 807 of this chapter subject to §862.9.

[52 FR 16122, May 1, 1987, as amended at 65 FR 2309, Jan. 14, 2000]

**§ 862.2230 Chromatographic separation material for clinical use.**

(a) *Identification*. A chromatographic separation material for clinical use is a device accessory (e.g., ion exchange absorbents, ion exchange resins, and ion papers) intended for use in ion exchange chromatography, a procedure in which a compound is separated from a solution.

(b) *Classification*. Class I (general controls). The device is exempt from the premarket notification procedures in subpart E of part 807 of this chapter subject to the limitations in §862.9.

[52 FR 16122, May 1, 1987, as amended at 61 FR 1119, Jan. 16, 1996; 66 FR 38788, July 25, 2001]

**§ 862.2250 Gas liquid chromatography system for clinical use.**

(a) *Identification*. A gas liquid chromatography system for clinical use is a device intended to separate one or more drugs or compounds from a mixture. Each of the constituents in a vaporized mixture of compounds is separated according to its vapor pressure. The device may include accessories such as columns, gases, column supports, and liquid coating.

(b) *Classification*. Class I (general controls). The device is exempt from the premarket notification procedures in subpart E of part 807 of this chapter subject to §862.9.

[52 FR 16122, May 1, 1987, as amended at 65 FR 2309, Jan. 14, 2000]

**21 CFR Ch. I (4–1–20 Edition)**

**§ 862.2260 High pressure liquid chromatography system for clinical use.**

(a) *Identification*. A high pressure liquid chromatography system for clinical use is a device intended to separate one or more drugs or compounds from a solution by processing the mixture of compounds (solutes) through a column packed with materials of uniform size (stationary phase) under the influence of a high pressure liquid (mobile phase). Separation of the solutes occurs either by absorption, sieving, partition, or selective affinity.

(b) *Classification*. Class I (general controls). The device is exempt from the premarket notification procedures in subpart E of part 807 of this chapter subject to §862.9.

[52 FR 16122, May 1, 1987, as amended at 65 FR 2309, Jan. 14, 2000]

**§ 862.2265 High throughput genomic sequence analyzer for clinical use.**

(a) *Identification*. A high throughput genomic sequence analyzer for clinical use is an analytical instrument system intended to generate, measure and sort signals in order to analyze nucleic acid sequences in a clinical sample. The device may include a signal reader unit; reagent handling, dedicated instrument control, and other hardware components; raw data storage mechanisms; data acquisition software; and software to process detected signals.

(b) *Classification*. Class II (special controls). The device is exempt from the premarket notification procedures in subpart E of part 807 of this chapter subject to the limitations in §862.9. The special controls for this device are:

(1) The labeling for the instrument system must reference legally marketed pre-analytical and analytical reagents to be used with the instrument system and include or reference legally marketed analytical software that includes sequence alignment and variant calling functions, to be used with the instrument system.

(2) The labeling for the instrument system must include a description of the following information:

(i) The specimen type(s) validated as an appropriate source of nucleic acid for this instrument.



(ii) The type(s) of nucleic acids (*e.g.*, germline DNA, tumor DNA) validated with this instrument.

(iii) The type(s) of sequence variations (*e.g.* single nucleotide variants, insertions, deletions) validated with this instrument.

(iv) The type(s) of sequencing (*e.g.*, targeted sequencing) validated with this instrument.

(v) The appropriate read depth for the sensitivity claimed and validation information supporting those claims.

(vi) The nucleic acid extraction method(s) validated for use with the instrument system.

(vii) Limitations must specify the types of sequence variations that the instrument cannot detect with the claimed accuracy and precision (*e.g.*, insertions or deletions larger than a certain size, translocations).

(viii) Performance characteristics of the instrument system must include:

(A) Reproducibility data generated using multiple instruments and multiple operators, and at multiple sites. Samples tested must include all claimed specimen types, nucleic acid types, sequence variation types, and types of sequencing. Variants queried shall be located in varying sequence context (*e.g.*, different chromosomes, GC-rich regions). Device results shall be compared to reference sequence data with high confidence.

(B) Accuracy data for all claimed specimen types and nucleic acid types generated by testing a panel of well characterized samples to query all claimed sequence variation types, types of sequencing, and sequences located in varying sequence context (*e.g.*, different chromosomes, GC-rich regions). The well-characterized sample panel shall include samples from at least two sources that have highly confident sequence based on well-validated sequencing methods. At least one reference source shall have sequence generated independently of the manufacturer with respect to technology and analysis. Percent agreement and percent disagreement with the reference sequences must be described for all regions queried by the instrument.

(C) If applicable, data describing endogenous or exogenous substances that

may interfere with the instrument system.

(D) If applicable, data demonstrating the ability of the system to consistently generate an accurate result for a given sample across different indexing primer combinations.

(ix) The upper and lower limit of input nucleic acid that will achieve the claimed accuracy and reproducibility. Data supporting such claims must also be summarized.

[82 FR 13552, Mar. 14, 2017, as amended at 84 FR 71797, Dec. 30, 2019]

**§ 862.2270 Thin-layer chromatography system for clinical use.**

(a) *Identification.* A thin-layer chromatography (TLC) system for clinical use is a device intended to separate one or more drugs or compounds from a mixture. The mixture of compounds is absorbed onto a stationary phase or thin layer of inert material (*e.g.*, cellulose, alumina, etc.) and eluted off by a moving solvent (moving phase) until equilibrium occurs between the two phases.

(b) *Classification.* Class I (general controls). The device is exempt from the premarket notification procedures in subpart E of part 807 of this chapter subject to § 862.9. Particular components of TLC systems, *i.e.*, the thin-layer chromatography apparatus, TLC atomizer, TLC developing tanks, and TLC ultraviolet light, are exempt from the current good manufacturing practice requirements of the quality system regulation in part 820 of this chapter, with the exception of § 820.180 of this chapter, with respect to general requirements concerning records, and § 820.198 of this chapter, with respect to complaint files.

[52 FR 16122, May 1, 1987, as amended at 65 FR 2309, Jan. 14, 2000]

**§ 862.2300 Colorimeter, photometer, or spectrophotometer for clinical use.**

(a) *Identification.* A colorimeter, a photometer, or a spectrophotometer for clinical use is an instrument intended to measure radiant energy emitted, transmitted, absorbed, or reflected under controlled conditions. The device may include a monochromator to produce light of a specific wavelength.

## § 862.2310

(b) *Classification.* Class I (general controls). The device is exempt from the premarket notification procedures in subpart E of part 807 of this chapter subject to § 862.9.

[52 FR 16122, May 1, 1987, as amended at 65 FR 2309, Jan. 14, 2000]

## § 862.2310 Clinical sample concentrator.

(a) *Identification.* A clinical sample concentrator is a device intended to concentrate (by dialysis, evaporation, etc.) serum, urine, cerebrospinal fluid, and other body fluids before the fluids are analyzed.

(b) *Classification.* Class I (general controls). The device is exempt from the premarket notification procedures in subpart E of part 807 of this chapter subject to the limitations in § 862.9.

[52 FR 16122, May 1, 1987, as amended at 60 FR 38899, July 28, 1995; 66 FR 38788, July 25, 2001]

## § 862.2320 Beta or gamma counter for clinical use.

(a) *Identification.* A beta or gamma counter for clinical use is a device intended to detect and count beta or gamma radiation emitted by clinical samples. Clinical samples are prepared by addition of a radioactive reagent to the sample. These measurements are useful in the diagnosis and treatment of various disorders.

(b) *Classification.* Class I (general controls). The device is exempt from the premarket notification procedures in subpart E of part 807 of this chapter subject to the limitations in § 862.9.

[52 FR 16122, May 1, 1987, as amended at 60 FR 38900, July 28, 1995; 66 FR 38788, July 25, 2001]

## § 862.2400 Densitometer/scanner (integrating, reflectance, TLC, or radiochromatogram) for clinical use.

(a) *Identification.* A densitometer/scanner (integrating, reflectance, thin-layer chromatography, or radiochromatogram) for clinical use is a device intended to measure the concentration of a substance on the surface of a film or other support media by either a photocell measurement of the light transmission through a given area of the medium or, in the case of

## 21 CFR Ch. I (4–1–20 Edition)

the radiochromatogram scanner, by measurement of the distribution of a specific radio-active element on a radiochromatogram.

(b) *Classification.* Class I (general controls). The device is exempt from the premarket notification procedures in subpart E of part 807 of this chapter subject to § 862.9.

[52 FR 16122, May 1, 1987, as amended at 65 FR 2309, Jan. 14, 2000]

## § 862.2485 Electrophoresis apparatus for clinical use.

(a) *Identification.* An electrophoresis apparatus for clinical use is a device intended to separate molecules or particles, including plasma proteins, lipoproteins, enzymes, and hemoglobulins on the basis of their net charge in specified buffered media. This device is used in conjunction with certain materials to measure a variety of analytes as an aid in the diagnosis and treatment of certain disorders.

(b) *Classification.* Class I (general controls). The device is exempt from the premarket notification procedures in subpart E of part 807 of this chapter subject to the limitations in § 862.9.

[52 FR 16122, May 1, 1987, as amended at 60 FR 38900, July 28, 1995; 66 FR 38788, July 25, 2001]

## § 862.2500 Enzyme analyzer for clinical use.

(a) *Identification.* An enzyme analyzer for clinical use is a device intended to measure enzymes in plasma or serum by nonkinetic or kinetic measurement of enzyme-catalyzed reactions. This device is used in conjunction with certain materials to measure a variety of enzymes as an aid in the diagnosis and treatment of certain enzyme-related disorders.

(b) *Classification.* Class I (general controls). The device is exempt from the premarket notification procedures in subpart E of part 807 of this chapter subject to § 862.9.

[52 FR 16122, May 1, 1987, as amended at 65 FR 2309, Jan. 14, 2000]

## § 862.2540 Flame emission photometer for clinical use.

(a) *Identification.* A flame emission photometer for clinical use is a device

intended to measure the concentration of sodium, potassium, lithium, and other metal ions in body fluids. Abnormal variations in the concentration of these substances in the body are indicative of certain disorders (e.g., electrolyte imbalance and heavy metal intoxication) and are, therefore, useful in diagnosis and treatment of those disorders.

(b) *Classification*. Class I (general controls). The device is exempt from the premarket notification procedures in subpart E of part 807 of this chapter subject to § 862.9.

[52 FR 16122, May 1, 1987, as amended at 65 FR 2309, Jan. 14, 2000]

**§ 862.2560 Fluorometer for clinical use.**

(a) *Identification*. A fluorometer for clinical use is a device intended to measure by fluorescence certain analytes. Fluorescence is the property of certain substances of radiating, when illuminated, a light of a different wavelength. This device is used in conjunction with certain materials to measure a variety of analytes.

(b) *Classification*. Class I (general controls). The device is exempt from the premarket notification procedures in subpart E of part 807 of this chapter subject to § 862.9.

[52 FR 16122, May 1, 1987, as amended at 65 FR 2309, Jan. 14, 2000]

**§ 862.2570 Instrumentation for clinical multiplex test systems.**

(a) *Identification*. Instrumentation for clinical multiplex test systems is a device intended to measure and sort multiple signals generated by an assay from a clinical sample. This instrumentation is used with a specific assay to measure multiple similar analytes that establish a single indicator to aid in diagnosis. Such instrumentation may be compatible with more than one specific assay. The device includes a signal reader unit, and may also integrate reagent handling, hybridization, washing, dedicated instrument control, and other hardware components, as well as raw data storage mechanisms, data acquisition software, and software to process detected signals.

(b) *Classification*. Class II (special controls). The device is exempt from

the premarket notification procedures in subpart E of part 807 of this chapter subject to the limitations in § 862.9. The special control is FDA's guidance document entitled "Class II Special Controls Guidance Document: Instrumentation for Clinical Multiplex Test Systems." See § 862.1(d) for the availability of this guidance document.

[70 FR 11868, Mar. 10, 2005, as amended at 84 FR 71797, Dec. 30, 2019]

**§ 862.2680 Microtitrator for clinical use.**

(a) *Identification*. A microtitrator for clinical use is a device intended for use in micronanalysis to measure the concentration of a substance by reacting it with a measure "micro" volume of a known standardized solution.

(b) *Classification*. Class I (general controls). The device is exempt from the premarket notification procedures in subpart E of part 807 of this chapter subject to § 862.9.

[52 FR 16122, May 1, 1987, as amended at 65 FR 2309, Jan. 14, 2000]

**§ 862.2700 Nephelometer for clinical use.**

(a) *Identification*. A nephelometer for clinical use is a device intended to estimate the concentration of particles in a suspension by measuring their light scattering properties (the deflection of light rays by opaque particles in their path). The device is used in conjunction with certain materials to measure the concentration of a variety of analytes.

(b) *Classification*. Class I (general controls). The device is exempt from the premarket notification procedures in subpart E of part 807 of this chapter subject to § 862.9.

[52 FR 16122, May 1, 1987, as amended at 65 FR 2309, Jan. 14, 2000]

**§ 862.2720 Plasma oncometer for clinical use.**

(a) *Identification*. A plasma oncometer for clinical use is a device intended to measure plasma oncotic pressure, which is that portion of the total plasma osmotic pressure contributed by protein and other molecules too large to pass through a specified semipermeable membrane. Because

## § 862.2730

variations in plasma oncotic pressure are indications of certain disorders, measurements of the variations are useful in the diagnosis and treatment of these disorders.

(b) *Classification*. Class I (general controls). The device is exempt from the premarket notification procedures in subpart E of part 807 of this chapter subject to the limitations in § 862.9.

[52 FR 16122, May 1, 1987, as amended at 60 FR 38900, July 28, 1995; 66 FR 38788, July 25, 2001]

## § 862.2730 Osmometer for clinical use.

(a) *Identification*. An osmometer for clinical use is a device intended to measure the osmotic pressure of body fluids. Osmotic pressure is the pressure required to prevent the passage of a solution with a lesser solute concentration into a solution with greater solute concentration when the two solutions are separated by a semipermeable membrane. The concentration of a solution affects its osmotic pressure, freezing point, and other physiochemical properties. Osmometers determine osmotic pressure by methods such as the measurement of the freezing point. Measurements obtained by this device are used in the diagnosis and treatment of body fluid disorders.

(b) *Classification*. Class I (general controls). The device is exempt from the premarket notification procedures in subpart E of part 807 of this chapter subject to § 862.9.

[52 FR 16122, May 1, 1987, as amended at 65 FR 2309, Jan. 14, 2000]

## § 862.2750 Pipetting and diluting system for clinical use.

(a) *Identification*. A pipetting and diluting system for clinical use is a device intended to provide an accurately measured volume of liquid at a specified temperature for use in certain test procedures. This generic type of device system includes serial, manual, automated, and semi-automated dilutors, pipettors, dispensers, and pipetting stations.

(b) *Classification*. Class I (general controls). The device is exempt from the premarket notification procedures in

## 21 CFR Ch. I (4–1–20 Edition)

subpart E of part 807 of this chapter subject to § 862.9.

[52 FR 16122, May 1, 1987, as amended at 65 FR 2309, Jan. 14, 2000]

## § 862.2800 Refractometer for clinical use.

(a) *Identification*. A refractometer for clinical use is a device intended to determine the amount of solute in a solution by measuring the index of refraction (the ratio of the velocity of light in a vacuum to the velocity of light in the solution). The index of refraction is used to measure the concentration of certain analytes (solutes), such as plasma total proteins and urinary total solids. Measurements obtained by this device are used in the diagnosis and treatment of certain conditions.

(b) *Classification*. Class I (general controls). The device is exempt from the premarket notification procedures in subpart E of part 807 of this chapter subject to the limitations in § 862.9.

[52 FR 16122, May 1, 1987, as amended at 60 FR 38900, July 28, 1995; 66 FR 38788, July 25, 2001]

## § 862.2850 Atomic absorption spectrophotometer for clinical use.

(a) *Identification*. An atomic absorption spectrophotometer for clinical use is a device intended to identify and measure elements and metals (e.g., lead and mercury) in human specimens. The metal elements are identified according to the wavelength and intensity of the light that is absorbed when the specimen is converted to the atomic vapor phase. Measurements obtained by this device are used in the diagnosis and treatment of certain conditions.

(b) *Classification*. Class I (general controls). The device is exempt from the premarket notification procedures in subpart E of part 807 of this chapter subject to § 862.9.

[52 FR 16122, May 1, 1987, as amended at 65 FR 2309, Jan. 14, 2000]

## § 862.2860 Mass spectrometer for clinical use.

(a) *Identification*. A mass spectrometer for clinical use is a device intended to identify inorganic or organic compounds (e.g., lead, mercury, and drugs) in human specimens by ionizing

the compound under investigation and separating the resulting ions by means of an electrical and magnetic field according to their mass.

(b) *Classification*. Class I (general controls). The device is exempt from the premarket notification procedures in subpart E of part 807 of this chapter subject to § 862.9.

[52 FR 16122, May 1, 1987, as amended at 65 FR 2309, Jan. 14, 2000]

**§ 862.2900 Automated urinalysis system.**

(a) *Identification*. An automated urinalysis system is a device intended to measure certain of the physical properties and chemical constituents of urine by procedures that duplicate manual urinalysis systems. This device is used in conjunction with certain materials to measure a variety of urinary analytes.

(b) *Classification*. Class I (general controls). The device is exempt from the premarket notification procedures in subpart E of part 807 of this chapter subject to § 862.9.

[52 FR 16122, May 1, 1987, as amended at 65 FR 2309, Jan. 14, 2000]

**§ 862.2920 Plasma viscometer for clinical use.**

(a) *Identification*. A plasma viscometer for clinical use is a device intended to measure the viscosity of plasma by determining the time period required for the plasma to flow a measured distance through a calibrated glass tube. Measurements obtained by this device are used to monitor changes in the amount of solids present in plasma in various disorders.

(b) *Classification*. Class I (general controls). The device is exempt from the premarket notification procedures in subpart E of part 807 of this chapter subject to the limitations in § 862.9.

[52 FR 16122, May 1, 1987, as amended at 60 FR 38900, July 28, 1995; 66 FR 38788, July 25, 2001]

**Subpart D—Clinical Toxicology Test Systems**

**§ 862.3030 Acetaminophen test system.**

(a) *Identification*. An acetaminophen test system is a device intended to

measure acetaminophen, an analgesic and fever reducing drug, in serum. Measurements obtained by this device are used in the diagnosis and treatment of acetaminophen overdose.

(b) *Classification*. Class II.

**§ 862.3035 Amikacin test system.**

(a) *Identification*. An amikacin test system is a device intended to measure amikacin, an aminoglycoside antibiotic drug, in serum and plasma. Measurements obtained by this device are used in the diagnosis and treatment of amikacin overdose and in monitoring levels of amikacin to ensure appropriate therapy.

(b) *Classification*. Class II.

**§ 862.3040 Alcohol test system.**

(a) *Identification*. An alcohol test system is a device intended to measure alcohol (e.g., ethanol, methanol, isopropanol, etc.) in human body fluids (e.g., serum, whole blood, and urine). Measurements obtained by this device are used in the diagnosis and treatment of alcohol intoxication and poisoning.

(b) *Classification*. Class II.

**§ 862.3050 Breath-alcohol test system.**

(a) *Identification*. A breath-alcohol test system is a device intended to measure alcohol in the human breath. Measurements obtained by this device are used in the diagnosis of alcohol intoxication.

(b) *Classification*. Class I (general controls). The device is exempt from the premarket notification procedures in subpart E of part 807 of this chapter subject to the limitations in § 862.9.

[52 FR 16122, May 1, 1987, as amended at 84 FR 71797, Dec. 30, 2019]

**§ 862.3080 Breath nitric oxide test system.**

(a) *Identification*. A breath nitric oxide test system is a device intended to measure fractional nitric oxide in human breath. Measurement of changes in fractional nitric oxide concentration in expired breath aids in evaluating an asthma patient's response to anti-inflammatory therapy, as an adjunct to established clinical and laboratory assessments of asthma.

## § 862.3100

## 21 CFR Ch. I (4–1–20 Edition)

A breath nitric oxide test system combines chemiluminescence detection of nitric oxide with a pneumotachograph, display, and dedicated software.

(b) *Classification.* Class II (special controls). The special control is FDA's guidance entitled "Class II Special Controls Guidance Document: Breath Nitric Oxide Test System." See § 862.1(d) for the availability of this guidance document.

[68 FR 40127, July 7, 2003]

### § 862.3100 Amphetamine test system.

(a) *Identification.* An amphetamine test system is a device intended to measure amphetamine, a central nervous system stimulating drug, in plasma and urine. Measurements obtained by this device are used in the diagnosis and treatment of amphetamine use or overdose and in monitoring levels of amphetamine to ensure appropriate therapy.

(b) *Classification.* Class II (special controls). An amphetamine test system is not exempt if it is intended for any use other than employment or insurance testing or is intended for Federal drug testing programs. The device is exempt from the premarket notification procedures in subpart E of part 807 of this chapter subject to the limitations in § 862.9, provided the test system is intended for employment and insurance testing and includes a statement in the labeling that the device is intended solely for use in employment and insurance testing, and does not include devices intended for Federal drug testing programs (*e.g.*, programs run by the Substance Abuse and Mental Health Services Administration (SAMHSA), the Department of Transportation (DOT), and the U.S. military).

[52 FR 16122, May 1, 1987, as amended at 84 FR 71797, Dec. 30, 2019]

### § 862.3110 Antimony test system.

(a) *Identification.* An antimony test system is a device intended to measure antimony, a heavy metal, in urine, blood, vomitus, and stomach contents. Measurements obtained by this device are used in the diagnosis and treatment of antimony poisoning.

(b) *Classification.* Class I.

### § 862.3120 Arsenic test system.

(a) *Identification.* An arsenic test system is a device intended to measure arsenic, a poisonous heavy metal, in urine, vomitus, stomach contents, nails, hair, and blood. Measurements obtained by this device are used in the diagnosis and treatment of arsenic poisoning.

(b) *Classification.* Class I.

### § 862.3150 Barbiturate test system.

(a) *Identification.* A barbiturate test system is a device intended to measure barbiturates, a class of hypnotic and sedative drugs, in serum, urine, and gastric contents. Measurements obtained by this device are used in the diagnosis and treatment of barbiturate use or overdose and in monitoring levels of barbiturate to ensure appropriate therapy.

(b) *Classification.* Class II (special controls). A barbiturate test system is not exempt if it is intended for any use other than employment or insurance testing or is intended for Federal drug testing programs. The device is exempt from the premarket notification procedures in subpart E of part 807 of this chapter subject to the limitations in § 862.9, provided the test system is intended for employment and insurance testing and includes a statement in the labeling that the device is intended solely for use in employment and insurance testing, and does not include devices intended for Federal drug testing programs (*e.g.*, programs run by the Substance Abuse and Mental Health Services Administration (SAMHSA), the Department of Transportation (DOT), and the U.S. military).

[52 FR 16122, May 1, 1987, as amended at 84 FR 71797, Dec. 30, 2019]

### § 862.3170 Benzodiazepine test system.

(a) *Identification.* A benzodiazepine test system is a device intended to measure any of the benzodiazepine compounds, sedative and hypnotic drugs, in blood, plasma, and urine. The benzodiazepine compounds include chlordiazepoxide, diazepam, oxazepam, chlorzepam, flurazepam, and nitrazepam. Measurements obtained by this device are used in the diagnosis and treatment of benzodiazepine use or

overdose and in monitoring levels of benzodiazepines to ensure appropriate therapy.

(b) *Classification*. Class II (special controls). A benzodiazepine test system is not exempt if it is intended for any use other than employment or insurance testing or is intended for Federal drug testing programs. The device is exempt from the premarket notification procedures in subpart E of part 807 of this chapter subject to the limitations in § 862.9, provided the test system is intended for employment and insurance testing and includes a statement in the labeling that the device is intended solely for use in employment and insurance testing, and does not include devices intended for Federal drug testing programs (e.g., programs run by the Substance Abuse and Mental Health Services Administration (SAMHSA), the Department of Transportation (DOT), and the U.S. military).

[52 FR 16122, May 1, 1987, as amended at 84 FR 71797, Dec. 30, 2019]

**§ 862.3200 Clinical toxicology calibrator.**

(a) *Identification*. A clinical toxicology calibrator is a device intended for medical purposes for use in a test system to establish points of reference that are used in the determination of values in the measurement of substances in human specimens. A clinical toxicology calibrator can be a mixture of drugs or a specific material for a particular drug (e.g., ethanol, lidocaine, etc.). (See also § 862.2 in this part.)

(b) *Classification*. Class II (special controls). The device is exempt from the premarket notification procedures in subpart E of part 807 of this chapter subject to the limitations in § 862.9.

[52 FR 16122, May 1, 1987, as amended at 84 FR 71797, Dec. 30, 2019]

**§ 862.3220 Carbon monoxide test system.**

(a) *Identification*. A carbon monoxide test system is a device intended to measure carbon monoxide or carboxyhemoglobin (carbon monoxide bound to the hemoglobin in the blood) in blood. Measurements obtained by this device are used in the diagnosis

and treatment of or confirmation of carbon monoxide poisoning.

(b) *Classification*. Class I (general controls). The device is exempt from the premarket notification procedures in subpart E of part 807 of this chapter subject to the limitations in § 862.9.

[52 FR 16122, May 1, 1987, as amended at 84 FR 71797, Dec. 30, 2019]

**§ 862.3240 Cholinesterase test system.**

(a) *Identification*. A cholinesterase test system is a device intended to measure cholinesterase (an enzyme that catalyzes the hydrolysis of acetylcholine to choline) in human specimens. There are two principal types of cholinesterase in human tissues. True cholinesterase is present at nerve endings and in erythrocytes (red blood cells) but is not present in plasma. Pseudo cholinesterase is present in plasma and liver but is not present in erythrocytes. Measurements obtained by this device are used in the diagnosis and treatment of cholinesterase inhibition disorders (e.g., insecticide poisoning and succinylcholine poisoning).

(b) *Classification*. Class I (general controls). The device is exempt from the premarket notification procedures in subpart E of part 807 of this chapter subject to the limitations in § 862.9.

[52 FR 16122, May 1, 1987, as amended at 84 FR 71797, Dec. 30, 2019]

**§ 862.3250 Cocaine and cocaine metabolite test system.**

(a) *Identification*. A cocaine and cocaine metabolite test system is a device intended to measure cocaine and a cocaine metabolite (benzoylecgonine) in serum, plasma, and urine. Measurements obtained by this device are used in the diagnosis and treatment of cocaine use or overdose.

(b) *Classification*. Class II (special controls). A cocaine and cocaine metabolite test system is not exempt if it is intended for any use other than employment or insurance testing or is intended for Federal drug testing programs. The device is exempt from the premarket notification procedures in subpart E of part 807 of this chapter subject to the limitations in § 862.9, provided the test system is intended for employment and insurance testing

## § 862.3270

and includes a statement in the labeling that the device is intended solely for use in employment and insurance testing, and does not include devices intended for Federal drug testing programs (*e.g.*, programs run by the Substance Abuse and Mental Health Services Administration (SAMHSA), the Department of Transportation (DOT), and the U.S. military).

[52 FR 16122, May 1, 1987, as amended at 84 FR 71797, Dec. 30, 2019]

### § 862.3270 Codeine test system.

(a) *Identification.* A codeine test system is a device intended to measure codeine (a narcotic pain-relieving drug) in serum and urine. Measurements obtained by this device are used in the diagnosis and treatment of codeine use or overdose and in monitoring levels of codeine to ensure appropriate therapy.

(b) *Classification.* Class II (special controls). A codeine test system is not exempt if it is intended for any use other than employment or insurance testing or is intended for Federal drug testing programs. The device is exempt from the premarket notification procedures in subpart E of part 807 of this chapter subject to the limitations in § 862.9, provided the test system is intended for employment and insurance testing and includes a statement in the labeling that the device is intended solely for use in employment and insurance testing, and does not include devices intended for Federal drug testing programs (*e.g.*, programs run by the Substance Abuse and Mental Health Services Administration (SAMHSA), the Department of Transportation (DOT), and the U.S. military).

[52 FR 16122, May 1, 1987, as amended at 84 FR 71798, Dec. 30, 2019]

### § 862.3280 Clinical toxicology control material.

(a) *Identification.* A clinical toxicology control material is a device intended to provide an estimation of the precision of a device test system and to detect and monitor systematic deviations from accuracy resulting from reagent or instrument defects. This generic type of device includes various single, and multi-analyte control materials.

## 21 CFR Ch. I (4–1–20 Edition)

(b) *Classification.* Class I (general controls). The device is exempt from the premarket notification procedures in subpart E of part 807 of this chapter subject to the limitations in § 862.9.

[52 FR 16122, May 1, 1987, as amended at 65 FR 2309, Jan. 14, 2000, 84 FR 71798, Dec. 30, 2019]

### § 862.3300 Digoxin test system.

(a) *Identification.* A digoxin test system is a device intended to measure digoxin, a cardiovascular drug, in serum and plasma. Measurements obtained by this device are used in the diagnosis and treatment of digoxin overdose and in monitoring levels of digoxin to ensure appropriate therapy.

(b) *Classification.* Class II.

### § 862.3320 Digoxin test system.

(a) *Identification.* A digoxin test system is a device intended to measure digoxin, a cardiovascular drug, in serum and plasma. Measurements obtained by this device are used in the diagnosis and treatment of digoxin overdose and in monitoring levels of digoxin to ensure appropriate therapy.

(b) *Classification.* Class II.

### § 862.3350 Diphenylhydantoin test system.

(a) *Identification.* A diphenylhydantoin test system is a device intended to measure diphenylhydantoin, an antiepileptic drug, in human specimens. Measurements obtained by this device are used in the diagnosis and treatment of diphenylhydantoin overdose and in monitoring levels of diphenylhydantoin to ensure appropriate therapy.

(b) *Classification.* Class II.

### § 862.3360 Drug metabolizing enzyme genotyping system.

(a) *Identification.* A drug metabolizing enzyme genotyping system is a device intended for use in testing deoxyribonucleic acid (DNA) extracted from clinical samples to identify the presence or absence of human genotypic markers encoding a drug metabolizing enzyme. This device is used as an aid in determining treatment choice and individualizing treatment



dose for therapeutics that are metabolized primarily by the specific enzyme about which the system provides genotypic information.

(b) *Classification*. Class II (special controls). The special control is FDA's guidance document entitled "Class II Special Controls Guidance Document: Drug Metabolizing Enzyme Genotyping Test System." See §862.1(d) for the availability of this guidance document.

[70 FR 11867, Mar. 10, 2005]

#### § 862.3380 Ethosuximide test system.

(a) *Identification*. An ethosuximide test system is a device intended to measure ethosuximide, an antiepileptic drug, in human specimens. Measurements obtained by this device are used in the diagnosis and treatment of ethosuximide overdose and in monitoring levels of ethosuximide to ensure appropriate therapy.

(b) *Classification*. Class II.

#### § 862.3450 Gentamicin test system.

(a) *Identification*. A gentamicin test system is a device intended to measure gentamicin, an antibiotic drug, in human specimens. Measurements obtained by this device are used in the diagnosis and treatment of gentamicin overdose and in monitoring levels of gentamicin to ensure appropriate therapy.

(b) *Classification*. Class II.

#### § 862.3520 Kanamycin test system.

(a) *Identification*. A kanamycin test system is a device intended to measure kanamycin, an antibiotic drug, in plasma and serum. Measurements obtained by this device are used in the diagnosis and treatment of kanamycin overdose and in monitoring levels of kanamycin to ensure appropriate therapy.

(b) *Classification*. Class II.

#### § 862.3550 Lead test system.

(a) *Identification*. A lead test system is a device intended to measure lead, a heavy metal, in blood and urine. Measurements obtained by this device are used in the diagnosis and treatment of lead poisoning.

(b) *Classification*. Class II.

#### § 862.3555 Lidocaine test system.

(a) *Identification*. A lidocaine test system is a device intended to measure lidocaine, an antiarrhythmic and anticonvulsant drug, in serum and plasma. Measurements obtained by this device are used in the diagnosis and treatment of lidocaine overdose or in monitoring levels of lidocaine to ensure appropriate therapy.

(b) *Classification*. Class II.

#### § 862.3560 Lithium test system.

(a) *Identification*. A lithium test system is a device intended to measure lithium (from the drug lithium carbonate) in serum or plasma. Measurements of lithium are used to assure that the proper drug dosage is administered in the treatment of patients with mental disturbances, such as manic-depressive illness (bipolar disorder).

(b) *Classification*. Class II.

#### § 862.3580 Lysergic acid diethylamide (LSD) test system.

(a) *Identification*. A lysergic acid diethylamide (LSD) test system is a device intended to measure lysergic acid diethylamide, a hallucinogenic drug, in serum, urine, and gastric contents. Measurements obtained by this device are used in the diagnosis and treatment of LSD use or overdose.

(b) *Classification*. Class II (special controls). A lysergic acid diethylamide (LSD) test system is not exempt if it is intended for any use other than employment or insurance testing or is intended for Federal drug testing programs. The device is exempt from the premarket notification procedures in subpart E of part 807 of this chapter subject to the limitations in §862.9, provided the test system is intended for employment and insurance testing and includes a statement in the labeling that the device is intended solely for use in employment and insurance testing, and does not include devices intended for Federal drug testing programs (*e.g.*, programs run by the Substance Abuse and Mental Health Services Administration (SAMHSA), the Department of Transportation (DOT), and the U.S. military).

[52 FR 16122, May 1, 1987, as amended at 84 FR 71798, Dec. 30, 2019]

**§ 862.3590**

**21 CFR Ch. I (4–1–20 Edition)**

**§ 862.3590 Meprobamate test system.**

(a) *Identification.* A meprobamate test system is a device intended to measure meprobamate in human specimens. Measurements obtained by this device are used to detect the presence of meprobamate to diagnose the use or overdose of meprobamate or structurally-related drug compounds (e.g., prodrugs).

(b) *Classification.* Class II (special controls). The special controls for this device are:

(1) Design verification and validation must include:

(i) Robust data demonstrating the accuracy of the device when used in the intended specimen matrix. The accuracy data must include a comparison between the meprobamate test system results and meprobamate results that are measured on an FDA-accepted measurement method that is specific and accurate (e.g., gas or liquid chromatography combined with tandem mass spectrometry).

(ii) Robust analytical data demonstrating the performance characteristics of the device, including, but not limited to, specificity, cross-reactivity to relevant endogenous and exogenous substances, and the reproducibility of analyte detection around the cutoff(s).

(2) The intended use of the device must not include an indication for use in monitoring therapeutic drug concentrations or informing dosing adjustment decisions.

(3) Your 21 CFR 809.10 labeling must include the following:

(i) If indicated for use as a screening test to identify preliminary results for further confirmation, the intended use must state “This assay provides only a preliminary analytical result. A more specific alternative chemical confirmatory method (e.g., gas or liquid chromatography and mass spectrometry) must be used to obtain a confirmed analytical result. Clinical consideration and professional judgment must be exercised with any drug of abuse test, particularly when the preliminary test result is positive.”

(ii) A limiting statement that reads as follows: “This test should not be used to monitor therapeutic drug con-

centrations or to inform dosing adjustment decisions.”

[83 FR 54876, Nov. 1, 2018]

**§ 862.3600 Mercury test system.**

(a) *Identification.* A mercury test system is a device intended to measure mercury, a heavy metal, in human specimens. Measurements obtained by this device are used in the diagnosis and treatment of mercury poisoning.

(b) *Classification.* Class I.

**§ 862.3610 Methamphetamine test system.**

(a) *Identification.* A methamphetamine test system is a device intended to measure methamphetamine, a central nervous system stimulating drug, in serum, plasma, and urine. Measurements obtained by this device are used in the diagnosis and treatment of methamphetamine use or overdose.

(b) *Classification.* Class II (special controls). A methamphetamine test system is not exempt if it is intended for any use other than employment or insurance testing or is intended for Federal drug testing programs. The device is exempt from the premarket notification procedures in subpart E of part 807 of this chapter subject to the limitations in § 862.9, provided the test system is intended for employment and insurance testing and includes a statement in the labeling that the device is intended solely for use in employment and insurance testing, and does not include devices intended for Federal drug testing programs (e.g., programs run by the Substance Abuse and Mental Health Services Administration (SAMHSA), the Department of Transportation (DOT), and the U.S. military).

[52 FR 16122, May 1, 1987, as amended at 84 FR 71798, Dec. 30, 2019]

**§ 862.3620 Methadone test system.**

(a) *Identification.* A methadone test system is a device intended to measure methadone, an addictive narcotic pain-relieving drug, in serum and urine. Measurements obtained by this device are used in the diagnosis and treatment of methadone use or overdose and

## Food and Drug Administration, HHS

## § 862.3645

to determine compliance with regulations in methadone maintenance treatment.

(b) *Classification.* Class II (special controls). A methadone test system is not exempt if it is intended for any use other than employment or insurance testing or is intended for Federal drug testing programs. The device is exempt from the premarket notification procedures in subpart E of part 807 of this chapter subject to the limitations in § 862.9, provided the test system is intended for employment and insurance testing and includes a statement in the labeling that the device is intended solely for use in employment and insurance testing, and does not include devices intended for Federal drug testing programs (*e.g.*, programs run by the Substance Abuse and Mental Health Services Administration (SAMHSA), the Department of Transportation (DOT), and the U.S. military).

[52 FR 16122, May 1, 1987, as amended at 84 FR 71798, Dec. 30, 2019]

### § 862.3630 Methaqualone test system.

(a) *Identification.* A methaqualone test system is a device intended to measure methaqualone, a hypnotic and sedative drug, in urine. Measurements obtained by this device are used in the diagnosis and treatment of methaqualone use or overdose.

(b) *Classification.* Class II (special controls). A methaqualone test system is not exempt if it is intended for any use other than employment or insurance testing or is intended for Federal drug testing programs. The device is exempt from the premarket notification procedures in subpart E of part 807 of this chapter subject to the limitations in § 862.9, provided the test system is intended for employment and insurance testing and includes a statement in the labeling that the device is intended solely for use in employment and insurance testing, and does not include devices intended for Federal drug testing programs (*e.g.*, programs run by the Substance Abuse and Mental Health Services Administration (SAMHSA), the Department of Trans-

portation (DOT), and the U.S. military).

[52 FR 16122, May 1, 1987, as amended at 84 FR 71798, Dec. 30, 2019]

### § 862.3640 Morphine test system.

(a) *Identification.* A morphine test system is a device intended to measure morphine, an addictive narcotic pain-relieving drug, and its analogs in serum, urine, and gastric contents. Measurements obtained by this device are used in the diagnosis and treatment of morphine use or overdose and in monitoring levels of morphine and its analogs to ensure appropriate therapy.

(b) *Classification.* Class II (special controls). A morphine test system is not exempt if it is intended for any use other than employment or insurance testing or is intended for Federal drug testing programs. The device is exempt from the premarket notification procedures in subpart E of part 807 of this chapter subject to the limitations in § 862.9, provided the test system is intended for employment and insurance testing and includes a statement in the labeling that the device is intended solely for use in employment and insurance testing, and does not include devices intended for Federal drug testing programs (*e.g.*, programs run by the Substance Abuse and Mental Health Services Administration (SAMHSA), the Department of Transportation (DOT), and the U.S. military).

[52 FR 16122, May 1, 1987, as amended at 84 FR 71798, Dec. 30, 2019]

### § 862.3645 Neuroleptic drugs radioreceptor assay test system.

(a) *Identification.* A neuroleptic drugs radioreceptor assay test system is a device intended to measure in serum or plasma the dopamine receptor blocking activity of neuroleptic drugs and their active metabolites. A neuroleptic drug has anti-psychotic action affecting principally psychomotor activity, is generally without hypnotic effects, and is a tranquilizer. Measurements obtained by this device are used to aid in determining whether a patient is taking the prescribed dosage level of such drugs.

(b) *Classification.* Class II.

**§ 862.3650**

**21 CFR Ch. I (4–1–20 Edition)**

**§ 862.3650 Opiate test system.**

(a) *Identification.* An opiate test system is a device intended to measure any of the addictive narcotic pain-relieving opiate drugs in blood, serum, urine, gastric contents, and saliva. An opiate is any natural or synthetic drug that has morphine-like pharmacological actions. The opiates include drugs such as morphine, morphine glucuronide, heroin, codeine, nalorphine, and meperidine. Measurements obtained by this device are used in the diagnosis and treatment of opiate use or overdose and in monitoring the levels of opiate administration to ensure appropriate therapy.

(b) *Classification.* Class II (special controls). An opiate test system is not exempt if it is intended for any use other than employment or insurance testing or is intended for Federal drug testing programs. The device is exempt from the premarket notification procedures in subpart E of part 807 of this chapter subject to the limitations in § 862.9, provided the test system is intended for employment and insurance testing and includes a statement in the labeling that the device is intended solely for use in employment and insurance testing, and does not include devices intended for Federal drug testing programs (*e.g.*, programs run by the Substance Abuse and Mental Health Services Administration (SAMHSA), the Department of Transportation (DOT), and the U.S. military).

[52 FR 16122, May 1, 1987, as amended at 84 FR 71798, Dec. 30, 2019]

**§ 862.3652 Organophosphate test system.**

(a) *Identification.* An organophosphate test system is a device intended to measure organophosphate metabolites quantitatively in human urine from individuals who have signs and symptoms consistent with cholinesterase poisoning. The data obtained by this device is intended to aid in the confirmation and investigation of organophosphate exposure.

(b) *Classification.* Class II (special controls). The special controls for this device are:

(1) The distribution of these devices is limited to laboratories with experi-

enced personnel who are trained to measure and evaluate organophosphate exposure and guide public health response.

(2) Analytical testing must demonstrate the device has appropriate performance characteristics, including adequate precision and accuracy across the measuring range and near medical decision points.

[82 FR 48415, Oct. 18, 2017]

**§ 862.3660 Phenobarbital test system.**

(a) *Identification.* A phenobarbital test system is a device intended to measure phenobarbital, an antiepileptic and sedative-hypnotic drug, in human specimens. Measurements obtained by this device are used in the diagnosis and treatment of phenobarbital use or overdose and in monitoring levels of phenobarbital to ensure appropriate therapy.

(b) *Classification.* Class II.

**§ 862.3670 Phenothiazine test system.**

(a) *Identification.* A phenothiazine test system is a device intended to measure any of the drugs of the phenothiazine class in human specimens. Measurements obtained by this device are used in the diagnosis and treatment of phenothiazine use or overdose.

(b) *Classification.* Class II.

**§ 862.3680 Primidone test system.**

(a) *Identification.* A primidone test system is a device intended to measure primidone, an antiepileptic drug, in human specimens. Measurements obtained by this device are used in the diagnosis and treatment of primidone overdose and in monitoring levels of primidone to ensure appropriate therapy.

(b) *Classification.* Class II.

**§ 862.3700 Propoxyphene test system.**

(a) *Identification.* A propoxyphene test system is a device intended to measure propoxyphene, a pain-relieving drug, in serum, plasma, and urine. Measurements obtained by this device are used in the diagnosis and treatment of propoxyphene use or overdose or in monitoring levels of

propoxyphene to ensure appropriate therapy.

(b) *Classification.* Class II (special controls). A propoxyphene test system is not exempt if it is intended for any use other than employment or insurance testing or is intended for Federal drug testing programs. The device is exempt from the premarket notification procedures in subpart E of part 807 of this chapter subject to the limitations in §862.9, provided the test system is intended for employment and insurance testing and includes a statement in the labeling that the device is intended solely for use in employment and insurance testing, and does not include devices intended for Federal drug testing programs (e.g., programs run by the Substance Abuse and Mental Health Services Administration (SAMHSA), the Department of Transportation (DOT), and the U.S. military).

[52 FR 16122, May 1, 1987, as amended at 84 FR 71798, Dec. 30, 2019]

**§ 862.3750 Quinine test system.**

(a) *Identification.* A quinine test system is a device intended to measure quinine, a fever-reducing and pain-relieving drug intended in the treatment of malaria, in serum and urine. Measurements obtained by this device are used in the diagnosis and treatment of quinine overdose and malaria.

(b) *Classification.* Class I.

[52 FR 16122, May 1, 1987, as amended at 53 FR 21450, June 8, 1988; 65 FR 2310, Jan. 14, 2000]

**§ 862.3800 Reagents for molecular diagnostic instrument test systems.**

(a) *Identification.* Reagents for molecular diagnostic test systems are reagents other than analyte specific reagents used as part of molecular diagnostic test systems, such as polymerases, nucleotides and nucleotide mixes, master mixes in which individual reagents are optimized to be used together, and labeled nucleic acid molecules.

(b) *Classification.* Class I (general controls). The device is exempt from the premarket notification procedure in

subpart E of part 807 of this chapter, subject to the limitations in §862.9.

[82 FR 61163, Dec. 27, 2017]

**§ 862.3830 Salicylate test system.**

(a) *Identification.* A salicylate test system is a device intended to measure salicylates, a class of analgesic, antipyretic and anti-inflammatory drugs that includes aspirin, in human specimens. Measurements obtained by this device are used in diagnosis and treatment of salicylate overdose and in monitoring salicylate levels to ensure appropriate therapy.

(b) *Classification.* Class II.

**§ 862.3840 Sirolimus test system.**

(a) *Identification.* A sirolimus test system is a device intended to quantitatively determine sirolimus concentrations in whole blood. Measurements are used as an aid in management of transplant patients receiving therapy with sirolimus.

(b) *Classification.* Class II (special controls). The special control is FDA's guidance document entitled "Class II Special Controls Guidance Document: Sirolimus Test Systems." See §862.1(d) for the availability of this guidance document.

[69 FR 58259, Sept. 30, 2004]

**§ 862.3850 Sulfonamide test system.**

(a) *Identification.* A sulfonamide test system is a device intended to measure sulfonamides, any of the antibacterial drugs derived from sulfanilamide, in human specimens. Measurements obtained by this device are used in the diagnosis and treatment of sulfonamide overdose and in monitoring sulfonamide levels to ensure appropriate therapy.

(b) *Classification.* Class I.

[52 FR 16122, May 1, 1987, as amended at 53 FR 21450, June 8, 1988; 65 FR 2310, Jan. 14, 2000]

**§ 862.3870 Cannabinoid test system.**

(a) *Identification.* A cannabinoid test system is a device intended to measure any of the cannabinoids, hallucinogenic compounds endogenous to marijuana, in serum, plasma, saliva, and urine. Cannabinoid compounds include *delta*-9-tetrahydrocannabinol,

**§ 862.3880**

cannabidiol, cannabiniol, and cannabichromene. Measurements obtained by this device are used in the diagnosis and treatment of cannabinoid use or abuse and in monitoring levels of cannabinoids during clinical investigational use.

(b) *Classification.* Class II (special controls). A cannabinoid test system is not exempt if it is intended for any use other than employment or insurance testing or is intended for Federal drug testing programs. The device is exempt from the premarket notification procedures in subpart E of part 807 of this chapter subject to the limitations in § 862.9, provided the test system is intended for employment and insurance testing and includes a statement in the labeling that the device is intended solely for use in employment and insurance testing, and does not include devices intended for Federal drug testing programs (e.g., programs run by the Substance Abuse and Mental Health Services Administration (SAMHSA), the Department of Transportation (DOT), and the U.S. military).

[52 FR 16122, May 1, 1987, as amended at 84 FR 71799, Dec. 30, 2019]

**§ 862.3880 Theophylline test system.**

(a) *Identification.* A theophylline test system is a device intended to measure theophylline (a drug used for stimulation of the muscles in the cardiovascular, respiratory, and central nervous systems) in serum and plasma. Measurements obtained by this device are used in the diagnosis and treatment of theophylline overdose or in monitoring levels of theophylline to ensure appropriate therapy.

(b) *Classification.* Class II.

**§ 862.3900 Tobramycin test system.**

(a) *Identification.* A tobramycin test system is a device intended to measure tobramycin, an aminoglycoside antibiotic drug, in plasma and serum. Measurements obtained by this device are used in the diagnosis and treatment of tobramycin overdose and in monitoring levels of tobramycin to ensure appropriate therapy.

(b) *Classification.* Class II.

**21 CFR Ch. I (4–1–20 Edition)**

**§ 862.3910 Tricyclic antidepressant drugs test system.**

(a) *Identification.* A tricyclic antidepressant drugs test system is a device intended to measure any of the tricyclic antidepressant drugs in serum. The tricyclic antidepressant drugs include imipramine, desipramine, amitriptyline, nortriptyline, protriptyline, and doxepin. Measurements obtained by this device are used in the diagnosis and treatment of chronic depression to ensure appropriate therapy.

(b) *Classification.* Class II (special controls). A tricyclic antidepressant drugs test system is not exempt if it is intended for any use other than employment or insurance testing or is intended for Federal drug testing programs. The device is exempt from the premarket notification procedures in subpart E of part 807 of this chapter subject to the limitations in § 862.9, provided the test system is intended for employment and insurance testing and includes a statement in the labeling that the device is intended solely for use in employment and insurance testing, and does not include devices intended for Federal drug testing programs (e.g., programs run by the Substance Abuse and Mental Health Services Administration (SAMHSA), the Department of Transportation (DOT), and the U.S. military).

[52 FR 16122, May 1, 1987, as amended at 84 FR 71799, Dec. 30, 2019]

**§ 862.3950 Vancomycin test system.**

(a) *Identification.* A vancomycin test system is a device intended to measure vancomycin, an antibiotic drug, in serum. Measurements obtained by this device are used in the diagnosis and treatment of vancomycin overdose and in monitoring the level of vancomycin to ensure appropriate therapy.

(b) *Classification.* Class II.

**PART 864—HEMATOLOGY AND PATHOLOGY DEVICES**

**Subpart A—General Provisions**

Sec.

864.1 Scope.

864.3 Effective dates of requirement for premarket approval.

864.9 Limitations of exemptions from section 510(k) of the Federal Food, Drug, and Cosmetic Act (the act).

#### Subpart B—Biological Stains

864.1850 Dye and chemical solution stains.  
 864.1860 Immunohistochemistry reagents and kits.  
 864.1865 Cervical intraepithelial neoplasia (CIN) test system.  
 864.1866 Lynch syndrome test systems.  
 864.1870 Early growth response 1 (EGR1) gene fluorescence in-situ hybridization (FISH) test system for specimen characterization.

#### Subpart C—Cell and Tissue Culture Products

864.2220 Synthetic cell and tissue culture media and components.  
 864.2240 Cell and tissue culture supplies and equipment.  
 864.2260 Chromosome culture kit.  
 864.2280 Cultured animal and human cells.  
 864.2360 Mycoplasma detection media and components.  
 864.2800 Animal and human sera.  
 864.2875 Balanced salt solutions or formulations.

#### Subpart D—Pathology Instrumentation and Accessories

864.3010 Tissue processing equipment.  
 864.3250 Specimen transport and storage container.  
 864.3260 OTC test sample collection systems for drugs of abuse testing.  
 864.3300 Cytocentrifuge.  
 864.3400 Device for sealing microsections.  
 864.3600 Microscopes and accessories.  
 864.3700 Whole slide imaging system.  
 864.3800 Automated slide stainer.  
 864.3875 Automated tissue processor.

#### Subpart E—Specimen Preparation Reagents

864.4010 General purpose reagent.  
 864.4020 Analyte specific reagents.  
 864.4400 Enzyme preparations.

#### Subpart F—Automated and Semi-Automated Hematology Devices

864.5200 Automated cell counter.  
 864.5220 Automated differential cell counter.  
 864.5240 Automated blood cell diluting apparatus.  
 864.5260 Automated cell-locating device.  
 864.5300 Red cell indices device.  
 864.5350 Microsedimentation centrifuge.  
 864.5400 Coagulation instrument.  
 864.5425 Multipurpose system for in vitro coagulation studies.

864.5600 Automated hematocrit instrument.  
 864.5620 Automated hemoglobin system.  
 864.5680 Automated heparin analyzer.  
 864.5700 Automated platelet aggregation system.  
 864.5800 Automated sedimentation rate device.  
 864.5850 Automated slide spinner.  
 864.5950 Blood volume measuring device.

#### Subpart G—Manual Hematology Devices

864.6100 Bleeding time device.  
 864.6150 Capillary blood collection tube.  
 864.6160 Manual blood cell counting device.  
 864.6400 Hematocrit measuring device.  
 864.6550 Occult blood test.  
 864.6600 Osmotic fragility test.  
 864.6650 Platelet adhesion test.  
 864.6675 Platelet aggregometer.  
 864.6700 Erythrocyte sedimentation rate test.

#### Subpart H—Hematology Kits and Packages

864.7010 Flow cytometric test system for hematopoietic neoplasms.  
 864.7040 Adenosine triphosphate release assay.  
 864.7060 Antithrombin III assay.  
 864.7100 Red blood cell enzyme assay.  
 864.7140 Activated whole blood clotting time tests.  
 864.7250 Erythropoietin assay.  
 864.7275 Euglobulin lysis time tests.  
 864.7280 Factor V Leiden DNA mutation detection systems.  
 864.7290 Factor deficiency test.  
 864.7300 Fibrin monomer paracoagulation test.  
 864.7320 Fibrinogen/fibrin degradation products assay.  
 864.7340 Fibrinogen determination system.  
 864.7360 Erythrocytic glucose-6-phosphate dehydrogenase assay.  
 864.7375 Glutathione reductase assay.  
 864.7400 Hemoglobin A<sub>2</sub> assay.  
 864.7415 Abnormal hemoglobin assay.  
 864.7425 Carboxyhemoglobin assay.  
 864.7440 Electrophoretic hemoglobin analysis system.  
 864.7455 Fetal hemoglobin assay.  
 864.7470 Glycosylated hemoglobin assay.  
 864.7490 Sulfhemoglobin assay.  
 864.7500 Whole blood hemoglobin assays.  
 864.7525 Heparin assay.  
 864.7660 Leukocyte alkaline phosphatase test.  
 864.7675 Leukocyte peroxidase test.  
 864.7695 Platelet factor 4 radioimmunoassay.  
 864.7720 Prothrombin consumption test.  
 864.7735 Prothrombin-proconvertin test and thrombotest.  
 864.7750 Prothrombin time test.  
 864.7825 Sickle cell test.

## § 864.1

- 864.7875 Thrombin time test.
- 864.7900 Thromboplastin generation test.
- 864.7925 Partial thromboplastin time tests.

### Subpart I—Hematology Reagents

- 864.8100 Bothrops atrox reagent.
- 864.8150 Calibrator for cell indices.
- 864.8165 Calibrator for hemoglobin or hematocrit measurement.
- 864.8175 Calibrator for platelet counting.
- 864.8185 Calibrator for red cell and white cell counting.
- 864.8200 Blood cell diluent.
- 864.8500 Lymphocyte separation medium.
- 864.8540 Red cell lysing reagent.
- 864.8625 Hematology quality control mixture.
- 864.8950 Russell viper venom reagent.

### Subpart J—Products Used In Establishments That Manufacture Blood and Blood Products

- 864.9050 Blood bank supplies.
- 864.9100 Empty container for the collection and processing of blood and blood components.
- 864.9125 Vacuum-assisted blood collection system.
- 864.9145 Processing system for frozen blood.
- 864.9160 Blood group substances of nonhuman origin for in vitro diagnostic use.
- 864.9165 Blood establishment computer software and accessories.
- 864.9175 Automated blood grouping and antibody test system.
- 864.9185 Blood grouping view box.
- 864.9195 Blood mixing devices and blood weighing devices.
- 864.9205 Blood and plasma warming device.
- 864.9225 Cell-freezing apparatus and reagents for in vitro diagnostic use.
- 864.9245 Automated blood cell separator.
- 864.9275 Blood bank centrifuge for in vitro diagnostic use.
- 864.9285 Automated cell-washing centrifuge for immuno-hematology.
- 864.9300 Automated Coombs test systems.
- 864.9320 Copper sulfate solution for specific gravity determinations.
- 864.9400 Stabilized enzyme solution.
- 864.9550 Lectins and protectins.
- 864.9575 Environmental chamber for storage of platelet concentrate.
- 864.9600 Potentiating media for in vitro diagnostic use.
- 864.9650 Quality control kit for blood banking reagents.
- 864.9700 Blood storage refrigerator and blood storage freezer.
- 864.9750 Heat-sealing device.

## 21 CFR Ch. I (4–1–20 Edition)

- 864.9875 Transfer set.

### Subpart K—Products Used In Establishments That Manufacture Human Cells, Tissues, and Cellular and Tissue-Based Products (HCT/Ps)

- 864.9900 Cord blood processing system and storage container.

AUTHORITY: 21 U.S.C. 351, 360, 360c, 360e, 360j, 360l, 371.

EDITORIAL NOTE: Nomenclature changes to part 864 appear at 73 FR 35341, June 23, 2008.

### Subpart A—General Provisions

#### § 864.1 Scope.

(a) This part sets forth the classification of hematology and pathology devices intended for human use that are in commercial distribution.

(b) The identification of a device in a regulation in this part is not a precise description of every device that is, or will be, subject to the regulation. A manufacturer who submits a pre-market notification submission for a device under part 807 may not show merely that the device is accurately described by the section title and identification provisions of a regulation in this part, but shall state why the device is substantially equivalent to other devices, as required by § 807.87.

(c) References in this part to regulatory sections of the Code of Federal Regulations are to chapter I of title 21, unless otherwise noted.

(d) Guidance documents referenced in this part are available on the Internet at <http://www.fda.gov/MedicalDevices/DeviceRegulationandGuidance/GuidanceDocuments/default.htm>.

[52 FR 17732, May 11, 1987, as amended at 69 FR 12273, Mar. 16, 2004; 78 FR 18233, Mar. 26, 2013; 79 FR 50552, Aug. 25, 2014]

#### § 864.3 Effective dates of requirement for premarket approval.

A device included in this part that is classified into class III (premarket approval) shall not be commercially distributed after the date shown in the regulation classifying the device unless the manufacturer has an approval under section 515 of the act (unless an exemption has been granted under section 520(g)(2) of the act). An approval under section 515 of the act consists of



FDA's issuance of an order approving an application for premarket approval (PMA) for the device or declaring completed a product development protocol (PDP) for the device.

(a) Before FDA requires that a device commercially distributed before the enactment date of the amendments, or a device that has been found substantially equivalent to such a device, has an approval under section 515 of the act FDA must promulgate a regulation under section 515(b) of the act requiring such approval, except as provided in paragraph (b) of this section. Such a regulation under section 515(b) of the act shall not be effective during the grace period ending on the 90th day after its promulgation or on the last day of the 30th full calendar month after the regulation that classifies the device into class III is effective, whichever is later. See section 501(f)(2)(B) of the act. Accordingly, unless an effective date of the requirement for premarket approval is shown in the regulation for a device classified into class III in this part, the device may be commercially distributed without FDA's issuance of an order approving a PMA or declaring completed a PDP for the device. If FDA promulgates a regulation under section 515(b) of the act requiring premarket approval for a device, section 501(f)(1)(A) of the act applies to the device.

(b) Any new, not substantially equivalent, device introduced into commercial distribution on or after May 28, 1976, including a device formerly marketed that has been substantially altered, is classified by statute (section 513(f) of the act) into class III without any grace period and FDA must have issued an order approving a PMA or declaring completed a PDP for the device before the device is commercially distributed unless it is reclassified. If FDA knows that a device being commercially distributed may be a "new" device as defined in this section because of any new intended use or other reasons, FDA may codify the statutory classification of the device into class III for such new use. Accordingly, the regulation for such a class III device states that as of the enactment date of the amendments, May 28, 1976, the device must have an approval under sec-

tion 515 of the act before commercial distribution.

[52 FR 17732, May 11, 1987]

**§ 864.9 Limitations of exemptions from section 510(k) of the Federal Food, Drug, and Cosmetic Act (the act).**

The exemption from the requirement of premarket notification (section 510(k) of the act) for a generic type of class I or II device is only to the extent that the device has existing or reasonably foreseeable characteristics of commercially distributed devices within that generic type or, in the case of in vitro diagnostic devices, only to the extent that misdiagnosis as a result of using the device would not be associated with high morbidity or mortality. Accordingly, manufacturers of any commercially distributed class I or II device for which FDA has granted an exemption from the requirement of premarket notification must still submit a premarket notification to FDA before introducing or delivering for introduction into interstate commerce for commercial distribution the device when:

(a) The device is intended for a use different from the intended use of a legally marketed device in that generic type of device; e.g., the device is intended for a different medical purpose, or the device is intended for lay use where the former intended use was by health care professionals only;

(b) The modified device operates using a different fundamental scientific technology than a legally marketed device in that generic type of device; e.g., a surgical instrument cuts tissue with a laser beam rather than with a sharpened metal blade, or an in vitro diagnostic device detects or identifies infectious agents by using deoxyribonucleic acid (DNA) probe or nucleic acid hybridization technology rather than culture or immunoassay technology; or

(c) The device is an in vitro device that is intended:

(1) For use in the diagnosis, monitoring, or screening of neoplastic diseases with the exception of immunohistochemical devices;

(2) For use in screening or diagnosis of familial or acquired genetic disorders, including inborn errors of metabolism;

(3) For measuring an analyte that serves as a surrogate marker for screening, diagnosis, or monitoring life-threatening diseases such as acquired immune deficiency syndrome (AIDS), chronic or active hepatitis, tuberculosis, or myocardial infarction or to monitor therapy;

(4) For assessing the risk of cardiovascular diseases;

(5) For use in diabetes management;

(6) For identifying or inferring the identity of a microorganism directly from clinical material;

(7) For detection of antibodies to microorganisms other than immunoglobulin G (IgG) or IgG assays when the results are not qualitative, or are used to determine immunity, or the assay is intended for use in matrices other than serum or plasma;

(8) For noninvasive testing as defined in § 812.3(k) of this chapter; and

(9) For near patient testing (point of care).

[65 FR 2310, Jan. 14, 2000]

### Subpart B—Biological Stains

#### § 864.1850 Dye and chemical solution stains.

(a) *Identification.* Dye and chemical solution stains for medical purposes are mixtures of synthetic or natural dyes or nondye chemicals in solutions used in staining cells and tissues for diagnostic histopathology, cytopathology, or hematology.

(b) *Classification.* Class I (general controls). These devices are exempt from the premarket notification procedures in subpart E of part 807 of this chapter subject to the limitations in § 864.9. These devices are also exempt from the current good manufacturing practice requirements of the quality system regulation in part 820 of this chapter, with the exception of § 820.180, with respect to general requirements concerning records, and § 820.198, with respect to complaint files.

[45 FR 60583, Sept. 12, 1980, as amended at 54 FR 25044, June 12, 1989; 66 FR 38789, July 25, 2001]

#### § 864.1860 Immunohistochemistry reagents and kits.

(a) *Identification.* Immunohistochemistry test systems (IHC's) are in vitro diagnostic devices consisting of polyclonal or monoclonal antibodies labeled with directions for use and performance claims, which may be packaged with ancillary reagents in kits. Their intended use is to identify, by immunological techniques, antigens in tissues or cytologic specimens. Similar devices intended for use with flow cytometry devices are not considered IHC's.

(b) *Classification of immunohistochemistry devices.* (1) Class I (general controls). Except as described in paragraphs (b)(2) and (b)(3) of this section, these devices are exempt from the premarket notification requirements in part 807, subpart E of this chapter. This exemption applies to IHC's that provide the pathologist with adjunctive diagnostic information that may be incorporated into the pathologist's report, but that is not ordinarily reported to the clinician as an independent finding. These IHC's are used after the primary diagnosis of tumor (neoplasm) has been made by conventional histopathology using nonimmunologic histochemical stains, such as hematoxylin and eosin. Examples of class I IHC's are differentiation markers that are used as adjunctive tests to subclassify tumors, such as keratin.

(2) Class II (special control, guidance document: "FDA Guidance for Submission of Immunohistochemistry Applications to the FDA," Center for Devices and Radiologic Health, 1998). These IHC's are intended for the detection and/or measurement of certain target analytes in order to provide prognostic or predictive data that are not directly confirmed by routine histopathologic internal and external control specimens. These IHC's provide the pathologist with information that is ordinarily reported as independent diagnostic information to the ordering clinician, and the claims associated with these data are widely accepted and supported by valid scientific evidence. Examples of class II IHC's are those intended for semiquantitative

measurement of an analyte, such as hormone receptors in breast cancer.

(3) Class III (premarket approval). IHC's intended for any use not described in paragraphs (b)(1) or (b)(2) of this section.

(c) *Date of PMA or notice of completion of a PDP is required.* As of May 28, 1976, an approval under section 515 of the Federal Food, Drug, and Cosmetic Act is required for any device described in paragraph (b)(3) of this section before this device may be commercially distributed. See §864.3.

[63 FR 30142, June 3, 1998]

**§ 864.1865 Cervical intraepithelial neoplasia (CIN) test system.**

(a) *Identification.* A cervical intraepithelial neoplasia (CIN) test system is a device used to detect a biomarker associated with CIN in human tissues. The device is indicated as an adjunct test and not to be used as a stand-alone device. The test results must be interpreted in the context of the patient's clinical history including, but not limited to, prior and current cervical biopsy results, Papanicolaou (Pap) test results, human papillomavirus (HPV) test results, and morphology on hematoxylin and eosin (H&E) stained sections. This device is not intended to detect the presence of HPV.

(b) *Classification.* Class II (special controls). The special controls for this device are:

(1) Premarket notification submissions must include the following information:

(i) The indications for use must specify the biomarker that is intended to be identified and its adjunct use (*e.g.*, adjunct to examination of H&E stained slides) to improve consistency in the diagnosis of CIN.

(ii) Summary of professional society recommendations, as applicable.

(iii) A detailed device description including:

(A) A detailed description of all test components, including all provided reagents and required, but not provided, ancillary reagents.

(B) A detailed description of instrumentation and equipment, including illustrations or photographs of non-standard equipment or manuals.

(C) If applicable, detailed documentation of the device software, including, but not limited to, stand-alone software applications and hardware-based devices that incorporate software.

(D) A detailed description of appropriate positive and negative controls that are recommended or provided.

(E) Detailed specifications for sample collection, processing, and storage.

(F) A detailed description of methodology and assay procedure.

(G) A description of the assay cutoff (the medical decision point between positive and negative) or other relevant criteria that distinguishes positive and negative results, including the rationale for the chosen cutoff or other relevant criteria and results supporting validation of the cutoff.

(H) Detailed specification of the criteria for test results interpretation and reporting.

(iv) Detailed information demonstrating the performance characteristics of the device, including:

(A) Analytical specificity studies such as, but not limited to, antibody characterization (*e.g.*, Western Blot, peptide inhibition analysis), studies conducted on panels of normal tissues and neoplastic tissues, interference by endogenous and exogenous substances as well as cross-reactivity, as applicable.

(B) Device analytical sensitivity data generated by testing an adequate number of samples from individuals with the target condition including limit of blank, limit of detection, and limit of quantification, as applicable.

(C) Device precision/reproducibility data to evaluate within-run, between-run, between-day, between-lot, between-site, between-reader, within-reader and total precision, as applicable, using a panel of samples covering the device measuring range and/or the relevant disease categories (*e.g.* No CIN, CIN1, CIN2, CIN3, cervical cancer) and testing in replicates across multiple, nonconsecutive days.

(D) Device robustness/guardbanding studies to assess the tolerance ranges for various critical test and specimen parameters.

(E) Device stability data, including real-time stability and shipping stability under various storage times,

temperatures, and freeze-thaw conditions.

(F) Data from a clinical study demonstrating clinical validity using well-characterized prospectively or retrospectively obtained clinical specimens, as appropriate, representative of the intended use population. The study must evaluate the consistency of the diagnosis of CIN, for example, by comparing the levels of agreements of diagnoses rendered by community pathologists to those rendered by a panel of expert pathologists. Agreement for each CIN diagnostic category (*e.g.*, No CIN, CIN1, CIN2, CIN3, cancer) and for alternate diagnostic categories (*e.g.*, No CIN, low grade squamous intraepithelial lesion (LSIL)-histology, high grade squamous intraepithelial lesion (HSIL)-histology, cancer) between reference diagnosis by expert pathologist and community pathologist must be evaluated, as applicable. In addition, agreements for CIN binary categories as  $\geq$ CIN2 (*i.e.*, CIN2 or CIN3 or cancer) and  $\leq$ CIN1 (*i.e.*, No CIN or CIN1) between reference diagnosis by expert pathologist with H&E staining and community pathologist with H&E staining and agreements for alternate CIN binary categories as  $\geq$ HSIL-histology (*i.e.*, HSIL-histology or cancer) and  $\leq$ LSIL-histology (*i.e.*, No CIN or LSIL-histology) between reference diagnosis by an expert pathologist with H&E + [biomarker specified in paragraph (b)(1)(i) of this section] and a community pathologist with H&E + [biomarker specified in paragraph (b)(1)(i) of this section] must be evaluated and compared, as applicable.

(G) The staining performance of the device as determined by the community pathologists during review of the study slides must be evaluated. The staining performance criteria assessed must include overall staining acceptability, background staining acceptability, and morphology acceptability, as applicable.

(H) Appropriate training requirements for users, including interpretation manual, as applicable.

(I) Identification of risk mitigation elements used by the device, including a description of all additional procedures, methods, and practices incorporated into the instructions for use

that mitigate risks associated with testing.

(2) The device's 21 CFR 809.10(b) compliant labeling must include a detailed description of the protocol, including the information described in paragraph (b)(1)(ii) of this section, as applicable, and a detailed description of the performance studies performed and the summary of the results, including those that relate to paragraph (b)(1)(ii) of this section, as applicable.

[83 FR 234, Jan. 3, 2018]

**§ 864.1866 Lynch syndrome test systems.**

(a) *Identification.* Lynch syndrome test systems are in vitro diagnostic tests for use with tumor tissue to identify previously diagnosed cancer patients at risk for having Lynch syndrome.

(b) *Classification.* Class II (special controls). The special controls for this device are:

(1) Premarket notification submissions must include the following information, as appropriate:

(i) A detailed description of all test components, including all provided reagents, and required but not provided, ancillary reagents.

(ii) A detailed description of instrumentation and equipment, including illustrations or photographs of non-standard equipment or manuals.

(iii) Detailed documentation of the device software, including, but not limited to, standalone software applications and hardware-based devices that incorporate software.

(iv) A detailed description of quality controls including appropriate positive and negative controls that are recommended or provided.

(v) Detailed specifications for sample collection, processing, and storage.

(vi) A detailed description of methodology and assay procedure.

(vii) A description of the assay cut-off (*i.e.*, the medical decision point between positive and negative results) or other relevant criteria that distinguishes positive and negative results, or ordinal classes of marker expression, including the rationale for the chosen cut-off or other relevant criteria and results supporting validation of the cut-off.

(viii) Detailed specification of the criteria for test result interpretation and reporting.

(ix) Detailed information demonstrating the performance characteristics of the device, including:

(A) Data from an appropriate study demonstrating clinical accuracy using well-characterized clinical specimens representative of the intended use population (*i.e.*, concordance to Deoxyribonucleic Acid (DNA) sequencing results of the Lynch syndrome associated genes or method comparison to the predicate device using samples with known alterations in genes representative of Lynch syndrome). Pre-specified acceptance criteria must be provided and followed.

(B) Appropriate device reproducibility data investigating all sources of variance (*e.g.*, for distributed tests, data generated using a minimum of three sites, of which at least two sites must be external sites). Each site must perform testing over a minimum of 5 nonconsecutive days evaluating a sample panel that spans the claimed measuring range, and includes the clinical threshold. Pre-specified acceptance criteria must be provided and followed.

(C) Data demonstrating reader reproducibility, both within-reader and between-reader, assessed by three readers over 3 nonconsecutive days at each site, including a 2 week washout period between reads, as appropriate.

(D) Device precision data using clinical samples spanning the measuring range and controls to evaluate the within-lot, between-lot, within-run, between run, and total variation.

(E) Analytical specificity studies including as appropriate, western blots, peptide inhibition, testing in normal tissues and neoplastic tissues, interference by endogenous and exogenous substances, and cross-reactivity and cross contamination testing.

(F) Device analytical sensitivity data generated by testing an adequate number of samples from individuals with the target condition such that prevalence of the biomarker in the target population is established.

(G) Device stability data, including real-time stability and in-use stability, and stability evaluating various stor-

age times, temperatures, and freeze-thaw conditions, as appropriate.

(H) The staining performance criteria assessed must include overall staining acceptability, background staining acceptability, and morphology acceptability, as appropriate.

(I) Appropriate training requirements for users, including interpretation manual, as applicable.

(J) Identification of risk mitigation elements used by the device, including a description of all additional procedures, methods, and practices incorporated into the instructions for use that mitigate risks associated with testing.

(2) The device's § 809.10(b) of this chapter compliant labeling must include a detailed description of the protocol, including the information described in paragraphs (b)(1)(i) through (viii) of this section, as appropriate, and a detailed description of the performance studies performed and the summary of the results, including those that relate to paragraph (b)(1)(ix) of this section, as appropriate.

[83 FR 8357, Feb. 27, 2018]

**§ 864.1870 Early growth response 1 (EGR1) gene fluorescence in-situ hybridization (FISH) test system for specimen characterization.**

(a) *Identification.* An early growth response 1 (EGR1) gene fluorescence in-situ hybridization (FISH) test system for specimen characterization is a device intended to detect the EGR1 probe target on chromosome 5q in bone marrow specimens from patients with acute myeloid leukemia (AML) or myelodysplastic syndrome (MDS). The assay results are intended to be interpreted only by a qualified pathologist or cytogeneticist. These devices do not include automated systems that directly report results without review and interpretation by a qualified pathologist or cytogeneticist. These devices also do not include any device intended for use to select patient therapy, predict patient response to therapy, or to screen for disease as well as any device with a claim for a particular diagnosis, prognosis, monitoring, or risk assessment.

(b) *Classification.* Class II (special controls). The special controls for this device are:

(1) Premarket notification submissions must also include the following information:

- (i) A detailed description of all probes included in the kit;
- (ii) Purpose of each probe;
- (iii) Probe molecular specificity;
- (iv) Probe specificity;
- (v) Probe limits;
- (vi) Probe sensitivity;
- (vii) Specification of required ancillary reagents, instrumentation, and equipment;
- (viii) Specification of the specimen collection, processing, storage and slide preparation methods;
- (ix) Specification of the assay procedure;
- (x) Specification of control elements that are incorporated into the recommended testing procedures;
- (xi) Specification of risk mitigation elements: Description of all additional procedures, methods, and practices incorporated into the directions for use that mitigate risks associated with testing;
- (xii) Specification of the criteria for test result interpretation and reporting;
- (xiii) Device analytical sensitivity data;
- (xiv) Device analytical specificity data;
- (xv) Device reference limit data;
- (xvi) Device precision/reproducibility data;
- (xvii) Device stability data to include:
  - (A) Real-time stability,
  - (B) Freeze-thaw stability,
  - (C) Transport and temperature stability,
  - (D) Post-hybridization signal stability,
  - (E) Photostability of probe, and
- (xviii) Documentation that demonstrates the clinical validity of the device. The documentation must include data from clinical studies, a minimum of two peer-reviewed published literature references using the specific device seeking marketing clearance, or both. Documentation for the clinical studies and peer-reviewed published lit-

erature references cited must include the following elements:

(A) Documentation that the sponsor’s probe was used in the literature reference,

- (B) Number and type of specimens,
- (C) Target population studied,
- (D) Upper reference limit, and
- (E) Range of positive probe results.

(2) Your §809.10(b)(12) of this chapter compliant labeling must include a statement summarizing the data identified in paragraphs (b)(1)(xiii) through (xviii) of this section and a description of the studies supporting the information, including the pre-specified acceptance criteria for these performance studies, justification for the pre-specified acceptance criteria, and whether the pre-specified acceptance criteria were met.

(3) Your §809.10 of this chapter compliant labeling must include:

- (i) A warning that reads “The assay results are intended to be interpreted only by a qualified pathologist or cytogeneticist.”
- (ii) A warning that reads “This device is not for high-risk uses such as selecting therapy, predicting therapeutic response or disease screening.”
- (iii) A warning that reads “The use of this device for diagnosis, monitoring or risk assessment has not been established.”

[79 FR 52196, Sept. 3, 2014]

**Subpart C—Cell And Tissue Culture Products**

**§864.2220 Synthetic cell and tissue culture media and components.**

(a) *Identification.* Synthetic cell and tissue culture media and components are substances that are composed entirely of defined components (e.g., amino acids, vitamins, inorganic salts) that are essential for the survival and development of cell lines of humans and other animals. This does not include tissue culture media for human ex vivo tissue and cell culture processing applications as described in §876.5885 of this chapter.

(b) *Classification.* Class I (general controls). The device is exempt from the premarket notification procedures in

## Food and Drug Administration, HHS

## § 864.2875

subpart E of part 807 of this chapter subject to the limitations in § 864.9.

[45 FR 60583, Sept. 12, 1980, as amended at 54 FR 25044, June 12, 1989; 66 FR 27024, May 16, 2001; 66 FR 38789, July 25, 2001]

### § 864.2240 Cell and tissue culture supplies and equipment.

(a) *Identification.* Cell and tissue culture supplies and equipment are devices that are used to examine, propagate, nourish, or grow cells and tissue cultures. These include such articles as slide culture chambers, perfusion and roller apparatus, cell culture suspension systems, and tissue culture flasks, disks, tubes, and roller bottles.

(b) *Classification.* Class I (general controls). These devices are exempt from the premarket notification procedures in subpart E of part 807 of this chapter subject to the limitations in § 864.9. If the devices are not labeled or otherwise represented as sterile, they are exempt from the current good manufacturing practice requirements of the quality system regulation in part 820 of this chapter, with the exception of § 820.180, with respect to general requirements concerning records, and § 820.198, with respect to complaint files.

[45 FR 60584, Sept. 12, 1980, as amended at 54 FR 25044, June 12, 1989; 66 FR 38789, July 25, 2001]

### § 864.2260 Chromosome culture kit.

(a) *Identification.* A chromosome culture kit is a device containing the necessary ingredients (e.g., Minimum Essential Media (MEM) of McCoy's 5A culture media, phytohemagglutinin, fetal calf serum, antibiotics, and heparin) used to culture tissues for diagnosis of congenital chromosome abnormalities.

(b) *Classification.* Class I (general controls). The device is exempt from the premarket notification procedures in subpart E of part 807 of this chapter subject to the limitations in § 864.9.

[45 FR 60585, Sept. 12, 1980, as amended at 54 FR 25044, June 12, 1989; 66 FR 38789, July 25, 2001]

### § 864.2280 Cultured animal and human cells.

(a) *Identification.* Cultured animal and human cells are in vitro cultivated

cell lines from the tissue of humans or other animals which are used in various diagnostic procedures, particularly diagnostic virology and cytogenetic studies.

(b) *Classification.* Class I (general controls). The device is exempt from the premarket notification procedures in subpart E of part 807 of this chapter subject to § 864.9.

[45 FR 60585, Sept. 12, 1980, as amended at 65 FR 2310, Jan. 14, 2000]

### § 864.2360 Mycoplasma detection media and components.

(a) *Identification.* Mycoplasma detection media and components are used to detect and isolate mycoplasma pleuropneumonia-like organisms (PPLO), a common microbial contaminant in cell cultures.

(b) *Classification.* Class I (general controls). These devices are exempt from the premarket notification procedures in subpart E of part 807 of this chapter subject to the limitations in § 864.9.

[45 FR 60586, Sept. 12, 1980, as amended at 54 FR 25044, June 12, 1989; 66 FR 38789, July 25, 2001]

### § 864.2800 Animal and human sera.

(a) *Identification.* Animal and human sera are biological products, obtained from the blood of humans or other animals, that provide the necessary growth-promoting nutrients in a cell culture system.

(b) *Classification.* Class I (general controls). These devices are exempt from the premarket notification procedures in subpart E of part 807 of this chapter subject to the limitations in § 864.9.

[45 FR 60586, Sept. 12, 1980, as amended at 54 FR 25044, June 12, 1989; 66 FR 38789, July 25, 2001]

### § 864.2875 Balanced salt solutions or formulations.

(a) *Identification.* A balanced salt solution or formulation is a defined mixture of salts and glucose in a simple medium. This device is included as a necessary component of most cell culture systems. This media component controls for pH, osmotic pressure, energy source, and inorganic ions.

(b) *Classification.* Class I (general controls). These devices are exempt from

## § 864.3010

the premarket notification procedures in subpart E of part 807 of this chapter subject to the limitations in § 864.9.

[45 FR 60586, Sept. 12, 1980, as amended at 54 FR 25044, June 12, 1989; 66 FR 38789, July 25, 2001]

### Subpart D—Pathology Instrumentation and Accessories

#### § 864.3010 Tissue processing equipment.

(a) *Identification.* Tissue processing equipment consists of devices used to prepare human tissue specimens for diagnostic histological examination by processing specimens through the various stages of decalcifying, infiltrating, sectioning, and mounting on microscope slides.

(b) *Classification.* Class I (general controls). These devices are exempt from the premarket notification procedures in subpart E of part 807 of this chapter subject to the limitations in § 864.9. The devices are also exempt from the current good manufacturing practice requirements of the quality system regulation in part 820 of this chapter, with the exception of § 820.180, with respect to general requirements concerning records, and § 820.198, with respect to complaint files.

[45 FR 60587, Sept. 12, 1980, as amended at 54 FR 25044, June 12, 1989; 66 FR 38789, July 25, 2001]

#### § 864.3250 Specimen transport and storage container.

(a) *Identification.* A specimen transport and storage container, which may be empty or prefilled, is a device intended to contain biological specimens, body waste, or body exudate during storage and transport in order that the matter contained therein can be destroyed or used effectively for diagnostic examination. If prefilled, the device contains a fixative solution or other general purpose reagent to preserve the condition of a biological specimen added to the container. This section does not apply to specimen transport and storage containers that are intended for use as part of an over-the-counter test sample collection system for drugs of abuse testing.

## 21 CFR Ch. I (4–1–20 Edition)

(b) *Classification.* Class I (general controls). The device is exempt from the premarket notification procedures in subpart E of part 807 of this chapter subject to § 864.9. If the device is not labeled or otherwise represented as sterile, it is exempt from the current good manufacturing practice requirements of the quality system regulation in part 820 of this chapter, with the exception of § 820.180 of this chapter, with respect to general requirements concerning records, and § 820.198 of this chapter, with respect to complaint files.

[54 FR 47206, Nov. 13, 1989, as amended at 65 FR 2310, Jan. 14, 2000; 65 FR 18234, Apr. 7, 2000]

#### § 864.3260 OTC test sample collection systems for drugs of abuse testing.

(a) *Identification.* An over-the-counter (OTC) test sample collection system for drugs of abuse testing is a device intended to: Collect biological specimens (such as hair, urine, sweat, or saliva), outside of a medical setting and not on order of a health care professional (e.g., in the home, insurance, sports, or workplace setting); maintain the integrity of such specimens during storage and transport in order that the matter contained therein can be tested in a laboratory for the presence of drugs of abuse or their metabolites; and provide access to test results and counseling. This section does not apply to collection, transport, or laboratory testing of biological specimens for the presence of drugs of abuse or their metabolites that is performed to develop evidence for law enforcement purposes.

(b) *Classification.* Class I (general controls). The device is exempt from the premarket notification requirements in part 807, subpart E of this chapter subject to the limitations in § 864.9 if it is sold, distributed, and used in accordance with the restrictions set forth in § 809.40 of this chapter. If the device is not labeled or otherwise represented as sterile, it is exempt from the current good manufacturing practice requirements of the quality system regulation in part 820 of this chapter, with the exception of § 820.198 of this chapter with respect to complaint files.

[65 FR 18234, Apr. 7, 2000]



**§ 864.3300 Cytocentrifuge.**

(a) *Identification.* A cytocentrifuge is a centrifuge used to concentrate cells from biological cell suspensions (e.g., cerebrospinal fluid) and to deposit these cells on a glass microscope slide for cytological examination.

(b) *Classification.* Class I (general controls). This device is exempt from the premarket notification procedures in subpart E of part 807 of this chapter subject to the limitations in § 864.9.

[45 FR 60588, Sept. 12, 1980, as amended at 54 FR 25044, June 12, 1989; 66 FR 38789, July 25, 2001]

**§ 864.3400 Device for sealing microsections.**

(a) *Identification.* A device for sealing microsections is an automated instrument used to seal stained cells and microsections for histological and cytological examination.

(b) *Classification.* Class I (general controls). This device is exempt from the premarket notification procedures in subpart E of part 807 of this chapter subject to the limitations in § 864.9.

[45 FR 60589, Sept. 12, 1980, as amended at 54 FR 25044, June 12, 1989; 66 FR 38789, July 25, 2001]

**§ 864.3600 Microscopes and accessories.**

(a) *Identification.* Microscopes and accessories are optical instruments used to enlarge images of specimens, preparations, and cultures for medical purposes. Variations of microscopes and accessories (through a change in the light source) used for medical purposes include the following:

(1) Phase contrast microscopes, which permit visualization of unstained preparations by altering the phase relationship of light that passes around the object and through the object.

(2) Fluorescence microscopes, which permit examination of specimens stained with fluorochromes that fluoresce under ultraviolet light.

(3) Inverted stage microscopes, which permit examination of tissue cultures or other biological specimens contained in bottles or tubes with the light source mounted above the specimen.

(b) *Classification.* Class I (general controls). These devices are exempt from the premarket notification procedures in subpart E of part 807 of this chapter subject to the limitations in § 864.9. If the device is not labeled or otherwise represented as sterile, it is exempt from the current good manufacturing practice requirements of the quality system regulation in part 820 of this chapter, with the exception of § 820.180, with respect to general requirements concerning records, and § 820.198, with respect to complaint files.

[45 FR 60590, Sept. 12, 1980, as amended at 54 FR 25044, June 12, 1989; 66 FR 38789, July 25, 2001]

**§ 864.3700 Whole slide imaging system.**

(a) *Identification.* The whole slide imaging system is an automated digital slide creation, viewing, and management system intended as an aid to the pathologist to review and interpret digital images of surgical pathology slides. The system generates digital images that would otherwise be appropriate for manual visualization by conventional light microscopy.

(b) *Classification.* Class II (special controls). The special controls for this device are:

(1) Premarket notification submissions must include the following information:

(i) The indications for use must specify the tissue specimen that is intended to be used with the whole slide imaging system and the components of the system.

(ii) A detailed description of the device and bench testing results at the component level, including for the following, as appropriate:

- (A) Slide feeder;
- (B) Light source;
- (C) Imaging optics;
- (D) Mechanical scanner movement;
- (E) Digital imaging sensor;
- (F) Image processing software;
- (G) Image composition techniques;
- (H) Image file formats;
- (I) Image review manipulation software;
- (J) Computer environment; and
- (K) Display system.

(iii) Detailed bench testing and results at the system level, including for the following, as appropriate:

**§ 864.3800**

**21 CFR Ch. I (4–1–20 Edition)**

- (A) Color reproducibility;
  - (B) Spatial resolution;
  - (C) Focusing test;
  - (D) Whole slide tissue coverage;
  - (E) Stitching error; and
  - (F) Turnaround time.
- (iv) Detailed information demonstrating the performance characteristics of the device, including, as appropriate:

(A) Precision to evaluate intra-system and inter-system precision using a comprehensive set of clinical specimens with defined, clinically relevant histologic features from various organ systems and diseases. Multiple whole slide imaging systems, multiple sites, and multiple readers must be included.

(B) Reproducibility data to evaluate inter-site variability using a comprehensive set of clinical specimens with defined, clinically relevant histologic features from various organ systems and diseases. Multiple whole slide imaging systems, multiple sites, and multiple readers must be included.

(C) Data from a clinical study to demonstrate that viewing, reviewing, and diagnosing digital images of surgical pathology slides prepared from tissue slides using the whole slide imaging system is non-inferior to using an optical microscope. The study should evaluate the difference in major discordance rates between manual digital (MD) and manual optical (MO) modalities when compared to the reference (*e.g.*, main sign-out diagnosis).

(D) A detailed human factor engineering process must be used to evaluate the whole slide imaging system user interface(s).

(2) Labeling compliant with 21 CFR 809.10(b) must include the following:

(i) The intended use statement must include the information described in paragraph (b)(1)(i) of this section, as applicable, and a statement that reads, “It is the responsibility of a qualified pathologist to employ appropriate procedures and safeguards to assure the validity of the interpretation of images obtained using this device.”

(ii) A description of the technical studies and the summary of results, including those that relate to paragraphs (b)(1)(ii) and (iii) of this section, as appropriate.

(iii) A description of the performance studies and the summary of results, including those that relate to paragraph (b)(1)(iv) of this section, as appropriate.

(iv) A limiting statement that specifies that pathologists should exercise professional judgment in each clinical situation and examine the glass slides by conventional microscopy if there is doubt about the ability to accurately render an interpretation using this device alone.

[83 FR 22, Jan. 2, 2018]

**§ 864.3800 Automated slide stainer.**

(a) *Identification.* An automated slide stainer is a device used to stain histology, cytology, and hematology slides for diagnosis.

(b) *Classification.* Class I (general controls). This device is exempt from the premarket notification procedures in subpart E of part 807 of this chapter subject to the limitations in § 864.9.

[45 FR 60591, Sept. 12, 1980, as amended at 54 FR 25044, June 12, 1989; 66 FR 38789, July 25, 2001]

**§ 864.3875 Automated tissue processor.**

(a) *Identification.* An automated tissue processor is an automated system used to process tissue specimens for examination through fixation, dehydration, and infiltration.

(b) *Classification.* Class I (general controls). This device is exempt from the premarket notification procedures in subpart E of part 807 of this chapter subject to the limitations in § 864.9.

[45 FR 60591, Sept. 12, 1980, as amended at 54 FR 25045, June 12, 1989; 66 FR 38789, July 25, 2001]

**Subpart E—Specimen Preparation Reagents**

**§ 864.4010 General purpose reagent.**

(a) A general purpose reagent is a chemical reagent that has general laboratory application, that is used to collect, prepare, and examine specimens from the human body for diagnostic purposes, and that is not labeled or otherwise intended for a specific diagnostic application. It may be either an individual substance, or multiple substances reformulated, which, when combined with or used in conjunction

with an appropriate analyte specific reagent (ASR) and other general purpose reagents, is part of a diagnostic test procedure or system constituting a finished in vitro diagnostic (IVD) test. General purpose reagents are appropriate for combining with one or more than one ASR in producing such systems and include labware or disposable constituents of tests; but they do not include laboratory machinery, automated or powered systems. General purpose reagents include cytological preservatives, decalcifying reagents, fixative and adhesives, tissue processing reagents, isotonic solutions and pH buffers. Reagents used in tests for more than one individual chemical substance or ligand are general purpose reagents (e.g., *Thermus aquaticus* (TAQ) polymerase, substrates for enzyme immunoassay (EIA)).

(b) *Classification*. Class I (general controls). The device is exempt from the premarket notification procedures in subpart E of part 807 of this chapter subject to the limitations in § 864.9. If the device is not labeled or otherwise represented as sterile, it is exempt from the current good manufacturing practice requirements of the quality system regulation in part 820 of this chapter, with the exception of § 820.180, with respect to general requirements concerning records, and § 820.198, with respect to complaint files.

[45 FR 60592, Sept. 12, 1980, as amended at 54 FR 25045, June 12, 1989; 62 FR 62260, Nov. 21, 1997; 66 FR 38789, July 25, 2001]

#### § 864.4020 Analyte specific reagents.

(a) *Identification*. Analyte specific reagents (ASR's) are antibodies, both polyclonal and monoclonal, specific receptor proteins, ligands, nucleic acid sequences, and similar reagents which, through specific binding or chemical reaction with substances in a specimen, are intended for use in a diagnostic application for identification and quantification of an individual chemical substance or ligand in biological specimens. ASR's that otherwise fall within this definition are not within the scope of subpart E of this part when they are sold to:

(1) In vitro diagnostic manufacturers; or

(2) Organizations that use the reagents to make tests for purposes other than providing diagnostic information to patients and practitioners, e.g., forensic, academic, research, and other nonclinical laboratories.

(b) *Classification*. (1) Class I (general controls). Except as described in paragraphs (b)(2) and (b)(3) of this section, these devices are exempt from the premarket notification requirements in part 807, subpart E of this chapter.

(2) Class II (special controls/guidance documents), when the analyte is used in blood banking tests that have been classified as class II devices (e.g., certain cytomegalovirus serological and treponema pallidum nontreponemal test reagents). Guidance Documents:

1. "Specifications for Immunological Testing for Infectious Disease; Approved Guideline," NCCLS Document I/LA18-A, December 1994.

2. "Assessment of the Clinical Accuracy of Laboratory Tests Using Receiver Operating Characteristic (ROC) Plots; Tentative Guideline," NCCLS Document KGP10-T, December 1993.

3. "Review Criteria for Assessment of In Vitro Diagnostic Devices for Direct Detection of *Mycobacterium* spp.," FDA, July 6, 1993, and its "Attachment 1," February 28, 1994.

4. "Draft Review Criteria for Nucleic Acid Amplification-Based In Vitro Diagnostic Devices for Direct Detection of Infectious Microorganisms," FDA, July 6, 1993.

5. The Center for Biologics Evaluation and Research, FDA, "Points to Consider in the Manufacture and Clinical Evaluation of In Vitro Tests to Detect Antibodies to the Human Immunodeficiency Virus, Type I" (54 FR 48943, November 28, 1989).

(3) Class III (premarket approval), when:

(i) The analyte is intended as a component in a test intended for use in the diagnosis of a contagious condition that is highly likely to result in a fatal outcome and prompt, accurate diagnosis offers the opportunity to mitigate the public health impact of the condition (e.g., human immunodeficiency virus (HIV/AIDS) or tuberculosis (TB)); or

(ii) The analyte is intended as a component in a test intended for use in donor screening for conditions for which FDA has recommended or required testing in order to safeguard the blood supply or establish the safe use

## § 864.4400

of blood and blood products (e.g., tests for hepatitis or tests for identifying blood groups).

(c) *Date of 510(k), or date of PMA or notice of completion of a product development protocol is required.* (1) Preamendments ASR's; No effective date has been established for the requirement for premarket approval for the device described in paragraph (b)(3) of this section. See § 864.3.

(2) For postamendments ASR's; November 23, 1998.

(d) *Restrictions.* Restrictions on the sale, distribution and use of ASR's are set forth in § 809.30 of this chapter.

[62 FR 62260, Nov. 21, 1997]

### § 864.4400 Enzyme preparations.

(a) *Identification.* Enzyme preparations are products that are used in the histopathology laboratory for the following purposes:

(1) To disaggregate tissues and cells already in established cultures for preparation into subsequent cultures (e.g., trypsin);

(2) To disaggregate fluid specimens for cytological examination (e.g., papain for gastric lavage or trypsin for sputum liquefaction);

(3) To aid in the selective staining of tissue specimens (e.g., diastase for glycogen determination).

(b) *Classification.* Class I (general controls). This device is exempt from the premarket notification procedures in subpart E of part 807 of this chapter subject to the limitations in § 864.9.

[45 FR 60592, Sept. 12, 1980, as amended at 54 FR 25045, June 12, 1989; 66 FR 38789, July 25, 2001]

## Subpart F—Automated and Semi-Automated Hematology Devices

### § 864.5200 Automated cell counter.

(a) *Identification.* An automated cell counter is a fully-automated or semi-automated device used to count red blood cells, white blood cells, or blood platelets using a sample of the patient's peripheral blood (blood circulating in one of the body's extremities, such as the arm). These devices may also measure hemoglobin or hematocrit and may also calculate or measure one or more of the red cell indices (the

## 21 CFR Ch. I (4–1–20 Edition)

erythrocyte mean corpuscular volume, the mean corpuscular hemoglobin, or the mean corpuscular hemoglobin concentration). These devices may use either an electronic particle counting method or an optical counting method.

(b) *Classification.* Class II (performance standards).

[45 FR 60593, Sept. 12, 1980]

### § 864.5220 Automated differential cell counter.

(a) *Identification.* An automated differential cell counter is a device used to identify one or more of the formed elements of the blood. The device may also have the capability to flag, count, or classify immature or abnormal hematopoietic cells of the blood, bone marrow, or other body fluids. These devices may combine an electronic particle counting method, optical method, or a flow cytometric method utilizing monoclonal CD (cluster designation) markers. The device includes accessory CD markers.

(b) *Classification.* Class II (special controls). The special control for this device is the FDA document entitled "Class II Special Controls Guidance Document: Premarket Notifications for Automated Differential Cell Counters for Immature or Abnormal Blood Cells; Final Guidance for Industry and FDA."

[67 FR 1607, Jan. 14, 2002]

### § 864.5240 Automated blood cell diluting apparatus.

(a) *Identification.* An automated blood cell diluting apparatus is a fully automated or semi-automated device used to make appropriate dilutions of a blood sample for further testing.

(b) *Classification.* Class I (general controls). The device is exempt from the premarket notification procedures in subpart E of part 807 of this chapter subject to § 864.9.

[45 FR 60596, Sept. 12, 1980, as amended at 65 FR 2310, Jan. 14, 2000]

### § 864.5260 Automated cell-locating device.

(a) *Identification.* An automated cell-locating device is a device used to locate blood cells on a peripheral blood smear, allowing the operator to identify and classify each cell according to

**Food and Drug Administration, HHS**

**§ 864.5680**

type. (Peripheral blood is blood circulating in one of the body's extremities, such as the arm.)

(b) *Classification*. Class II (performance standards).

[45 FR 60597, Sept. 12, 1980]

**§ 864.5300 Red cell indices device.**

(a) *Identification*. A red cell indices device, usually part of a larger system, calculates or directly measures the erythrocyte mean corpuscular volume (MCV), the mean corpuscular hemoglobin (MCH), and the mean corpuscular hemoglobin concentration (MCHC). The red cell indices are used for the differential diagnosis of anemias.

(b) *Classification*. Class II (performance standards).

[45 FR 60597, Sept. 12, 1980]

**§ 864.5350 Microsedimentation centrifuge.**

(a) *Identification*. A microsedimentation centrifuge is a device used to sediment red cells for the microsedimentation rate test.

(b) *Classification*. Class I (general controls). This device is exempt from the premarket notification procedures in subpart E of part 807 of this chapter subject to the limitations in § 864.9.

[45 FR 60598, Sept. 12, 1980, as amended at 59 FR 63007, Dec. 7, 1994; 66 FR 38789, July 25, 2001]

**§ 864.5400 Coagulation instrument.**

(a) *Identification*. A coagulation instrument is an automated or semiautomated device used to determine the onset of clot formation for in vitro coagulation studies.

(b) *Classification*. Class II (special controls). A fibrometer or coagulation timer intended for use with a coagulation instrument is exempt from the premarket notification procedures in subpart E of part 807 of this chapter subject to the limitations in § 864.9.

[45 FR 60598, Sept. 12, 1980, as amended at 84 FR 71799, Dec. 30, 2019]

**§ 864.5425 Multipurpose system for in vitro coagulation studies.**

(a) *Identification*. A multipurpose system for in vitro coagulation studies is a device consisting of one automated or

semiautomated instrument and its associated reagents and controls. The system is used to perform a series of coagulation studies and coagulation factor assays.

(b) *Classification*. Class II (special controls). A control intended for use with a multipurpose system for in vitro coagulation studies is exempt from the premarket notification procedures in subpart E of part 807 of this chapter subject to the limitations in § 864.9.

[45 FR 60599, Sept. 12, 1980, as amended at 84 FR 71799, Dec. 30, 2019]

**§ 864.5600 Automated hematocrit instrument.**

(a) *Identification*. An automated hematocrit instrument is a fully automated or semi-automated device which may or may not be part of a larger system. This device measures the packed red cell volume of a blood sample to distinguish normal from abnormal states, such as anemia and erythrocytosis (an increase in the number of red cells).

(b) *Classification*. Class II (performance standards).

[45 FR 60600, Sept. 12, 1980]

**§ 864.5620 Automated hemoglobin system.**

(a) *Identification*. An automated hemoglobin system is a fully automated or semi-automated device which may or may not be part of a larger system. The generic type of device consists of the reagents, calibrators, controls, and instrumentation used to determine the hemoglobin content of human blood.

(b) *Classification*. Class II (performance standards).

[45 FR 60601, Sept. 12, 1980]

**§ 864.5680 Automated heparin analyzer.**

(a) *Identification*. An automated heparin analyzer is a device used to determine the heparin level in a blood sample by mixing the sample with protamine (a heparin-neutralizing substance) and determining photometrically the onset of air-activated clotting. The analyzer also determines the amount of protamine necessary to neutralize the heparin in the patient's circulation.

## § 864.5700

(b) *Classification*. Class II (special controls).

[45 FR 60601, Sept. 12, 1980, as amended at 52 FR 17733, May 11, 1987; 58 FR 51571, Oct. 4, 1993]

### § 864.5700 Automated platelet aggregation system.

(a) *Identification*. An automated platelet aggregation system is a device used to determine changes in platelet shape and platelet aggregation following the addition of an aggregating reagent to a platelet-rich plasma.

(b) *Classification*. Class II (performance standards).

[45 FR 60602, Sept. 12, 1980]

### § 864.5800 Automated sedimentation rate device.

(a) *Identification*. An automated sedimentation rate device is an instrument that measures automatically the erythrocyte sedimentation rate in whole blood. Because an increased sedimentation rate indicates tissue damage or inflammation, the erythrocyte sedimentation rate device is useful in monitoring treatment of a disease.

(b) *Classification*. Class I (general controls). This device is exempt from the premarket notification procedures in subpart E of part 807 of this chapter subject to the limitations in § 864.9.

[45 FR 60602, Sept. 12, 1980, as amended at 54 FR 25045, June 12, 1989; 66 FR 38790, July 25, 2001]

### § 864.5850 Automated slide spinner.

(a) *Identification*. An automated slide spinner is a device that prepares automatically a blood film on a microscope slide using a small amount of peripheral blood (blood circulating in one of the body's extremities, such as the arm).

(b) *Classification*. Class I (general controls). This device is exempt from the premarket notification procedures in subpart E of part 807 of this chapter subject to the limitations in § 864.9.

[45 FR 60603, Sept. 12, 1980, as amended at 54 FR 25045, June 12, 1989; 66 FR 38790, July 25, 2001]

## 21 CFR Ch. I (4-1-20 Edition)

### § 864.5950 Blood volume measuring device.

(a) *Identification*. A blood volume measuring device is a manual, semi-automated, or automated system that is used to calculate the red cell mass, plasma volume, and total blood volume.

(b) *Classification*. Class II (performance standards).

[45 FR 60603, Sept. 12, 1980]

## Subpart G—Manual Hematology Devices

### § 864.6100 Bleeding time device.

(a) *Identification*. A bleeding time device is a device, usually employing two spring-loaded blades, that produces two small incisions in the patient's skin. The length of time required for the bleeding to stop is a measure of the effectiveness of the coagulation system, primarily the platelets.

(b) *Classification*. Class II (special controls). The device is exempt from the premarket notification procedures in subpart E of part 807 of this chapter subject to § 864.9.

[45 FR 60604, Sept. 12, 1980, as amended at 63 FR 59225, Nov. 3, 1998]

### § 864.6150 Capillary blood collection tube.

(a) *Identification*. A capillary blood collection tube is a plain or heparinized glass tube of very small diameter used to collect blood by capillary action.

(b) *Classification*. Class I (general controls). The device is exempt from the premarket notification procedures in subpart E of part 807 of this chapter subject to § 864.9.

[45 FR 60604, Sept. 12, 1980, as amended at 54 FR 25045, June 12, 1989; 65 FR 2310, Jan. 14, 2000]

### § 864.6160 Manual blood cell counting device.

(a) *Identification*. A manual blood cell counting device is a device used to count red blood cells, white blood cells, or blood platelets.

(b) *Classification*. Class I (general controls). This device is exempt from the premarket notification procedures in

## Food and Drug Administration, HHS

## § 864.7010

subpart E of part 807 of this chapter subject to the limitations in § 864.9.

[45 FR 60605, Sept. 12, 1980, as amended at 54 FR 25045, June 12, 1989; 66 FR 38790, July 25, 2001]

### § 864.6400 Hematocrit measuring device.

(a) *Identification.* A hematocrit measuring device is a system consisting of instruments, tubes, racks, and a sealer and a holder. The device is used to measure the packed red cell volume in blood to determine whether the patient's total red cell volume is normal or abnormal. Abnormal states include anemia (an abnormally low total red cell volume) and erythrocytosis (an abnormally high total red cell mass). The packed red cell volume is produced by centrifuging a given volume of blood.

(b) *Classification.* Class II (special controls). The device is exempt from the premarket notification procedures in subpart E of part 807 of this chapter subject to § 864.9.

[45 FR 60606, Sept. 12, 1980, as amended at 63 FR 59225, Nov. 3, 1998]

### § 864.6550 Occult blood test.

(a) *Identification.* An occult blood test is a device used to detect occult blood in urine or feces. (Occult blood is blood present in such small quantities that it can be detected only by chemical tests of suspected material, or by microscopic or spectroscopic examination.)

(b) *Classification.* Class II (special controls). A control intended for use with an occult blood test is exempt from the premarket notification procedures in subpart E of part 807 of this chapter subject to the limitations in § 864.9.

[45 FR 60606, Sept. 12, 1980, as amended at 84 FR 71799, Dec. 30, 2019]

### § 864.6600 Osmotic fragility test.

(a) *Identification.* An osmotic fragility test is a device used to determine the resistance of red blood cells to hemolysis (destruction) in varying concentrations of hypotonic saline solutions.

(b) *Classification.* Class I (general controls). This device is exempt from the premarket notification procedures in

subpart E of part 807 of this chapter subject to the limitations in § 864.9.

[45 FR 60607, Sept. 12, 1980, as amended at 54 FR 25045, June 12, 1989; 66 FR 38790, July 25, 2001]

### § 864.6650 Platelet adhesion test.

(a) *Identification.* A platelet adhesion test is a device used to determine in vitro platelet function.

(b) *Classification.* Class II (performance standards).

[45 FR 60608, Sept. 12, 1980]

### § 864.6675 Platelet aggregometer.

(a) *Identification.* A platelet aggregometer is a device, used to determine changes in platelet shape and platelet aggregation following the addition of an aggregating reagent to a platelet rich plasma.

(b) *Classification.* Class II (performance standards).

[45 FR 60608, Sept. 12, 1980]

### § 864.6700 Erythrocyte sedimentation rate test.

(a) *Identification.* An erythrocyte sedimentation rate test is a device that measures the length of time required for the red cells in a blood sample to fall a specified distance or a device that measures the degree of sedimentation taking place in a given length of time. An increased rate indicates tissue damage or inflammation.

(b) *Classification.* Class I (general controls). This device is exempt from the premarket notification procedures in subpart E of part 807 of this chapter subject to the limitations in § 864.9.

[45 FR 60608, Sept. 12, 1980, as amended at 54 FR 25045, June 12, 1989; 66 FR 38790, July 25, 2001]

## Subpart H—Hematology Kits and Packages

### § 864.7010 Flow cytometric test system for hematopoietic neoplasms.

(a) *Identification.* A flow cytometric test for hematopoietic neoplasms is a device that consists of reagents for immunophenotyping of human cells in relation to the level of expression, antigen density, and distribution of

specific cellular markers. These reagents are used as an aid in the differential diagnosis or monitoring of hematologically abnormal patients having or suspected of having hematopoietic neoplasms. The results should be interpreted by a pathologist or equivalent professional in conjunction with other clinical and laboratory findings.

(b) *Classification.* Class II (special controls). The special controls for this device are:

(1) Premarket notification submissions must include the following information:

(i) The indications for use must indicate the clinical hematopoietic neoplasms for which the assay was designed and validated, for example, chronic leukemia or lymphoma.

(ii) A detailed device description including the following:

(A) A detailed description of all test components, all required reagents, and all instrumentation and equipment, including illustrations or photographs of nonstandard equipment or methods.

(B) Detailed documentation of the device software including, but not limited to, standalone software applications and hardware-based devices that incorporate software.

(C) A detailed description of methodology and assay procedure.

(D) A description of appropriate internal and external quality control materials that are recommended or provided. The description must identify those control elements that are incorporated into the testing procedure, if applicable.

(E) Detailed specifications for sample collection, processing, and storage.

(F) Detailed specification of the criteria for test results interpretation and reporting including pre-established templates.

(G) If applicable, based on the output of the results, a description of the specific number of events to collect, result outputs, and analytical sensitivity of the assay that will be reported.

(iii) Information that demonstrates the performance characteristics of the test, including:

(A) Device performance data from either a method comparison study comparing the specific lymphocyte cell

markers to a predicate device or data collected through a clinical study demonstrating clinical validity using well-characterized clinical specimens. Samples must be representative of the intended use population of the device including hematologic neoplasms and the specific sample types for which the test is indicated for use.

(B) If applicable, device performance data from a clinical study demonstrating clinical validity for parameters not established in a predicate device of this generic type using well-characterized prospectively obtained clinical specimens including all hematologic neoplasms and the specific sample types for which the device is indicated for use.

(C) Device precision data using clinical samples to evaluate the within-lot, between-lot, within-run, between run, site-to-site and total variation using a minimum of three sites, of which at least two sites must be external sites. Results shall be reported as the standard deviation and percentage coefficient of variation for each level tested.

(D) Reproducibility data generated using a minimum of three lots of reagents to evaluate mean fluorescence intensity and variability of the recovery of the different markers and/or cell populations.

(E) Data from specimen and reagent carryover testing performed using well-established methods (*e.g.*, CLSI H26-A2).

(F) Specimen and prepared sample stability data established for each specimen matrix in the anticoagulant combinations and storage/use conditions that will be indicated.

(G) A study testing anticoagulant equivalency in all claimed specimen type/anticoagulant combinations using clinical specimens that are representative of the intended use population of the device.

(H) Analytic sensitivity data using a dilution panel created from clinical samples.

(I) Analytical specificity data, including interference and cross-contamination.

(J) Device stability data, including real-time stability of reagents under various storage times and temperatures.



(K) For devices that include polyclonal antibodies, Fluorescence Minus One (FMO) studies to evaluate non-specific binding for all polyclonal antibodies. Each FMO tube is compared to reagent reference to demonstrate that no additional population appears when one marker is absent. Pre-specified acceptance criteria must be provided and followed.

(L) For devices indicated for use as a semi-quantitative test, linearity data using a dilution panel created from clinical samples.

(M) For devices indicated for use as a semi-quantitative test, clinically relevant analytical sensitivity data, including limit of blank, limit of detection, and limit of quantification.

(iv) Identification of risk mitigation elements used by the device, including a detailed description of all additional procedures, methods, and practices incorporated into the instructions for use that mitigate risks associated with testing the device.

(2) The 21 CFR 809.10 compliant labeling must include the following:

(i) The intended use statement in the 21 CFR 809.10(a)(2) and (b)(2) compliant labeling must include a statement that the results should be interpreted by a pathologist or equivalent professional in conjunction with other clinical and laboratory findings. The intended use statement must also include information on what the device detects and measures, whether the device is qualitative, semi-quantitative, and/or quantitative, the clinical indications for which the device is to be used, and the specific population(s) for which the device is intended.

(ii) A detailed description of the performance studies conducted to comply with paragraph (b)(1)(iii) of this section and a summary of the results.

(3) As part of the risk management activities performed under 21 CFR 820.30 design controls, product labeling and instruction manuals must include clear examples of all expected phenotypic patterns and gating strategies using well-defined clinical samples representative of both abnormal and normal cellular populations. These samples must be selected based upon

the indications described in paragraph (b)(1)(i) of this section.

[82 FR 61165, Dec. 27, 2017]

**§ 864.7040 Adenosine triphosphate release assay.**

(a) *Identification.* An adenosine triphosphate release assay is a device that measures the release of adenosine triphosphate (ATP) from platelets following aggregation. This measurement is made on platelet-rich plasma using a photometer and a luminescent firefly extract. Simultaneous measurements of platelet aggregation and ATP release are used to evaluate platelet function disorders.

(b) *Classification.* Class I (general controls). The device is exempt from the premarket notification procedures in subpart E of part 807 of this chapter subject to the limitations in § 864.9.

[45 FR 60609, Sept. 12, 1980, as amended at 84 FR 71799, Dec. 30, 2019]

**§ 864.7060 Antithrombin III assay.**

(a) *Identification.* An antithrombin III assay is a device that is used to determine the plasma level of antithrombin III (a substance which acts with the anticoagulant heparin to prevent coagulation). This determination is used to monitor the administration of heparin in the treatment of thrombosis. The determination may also be used in the diagnosis of thrombophilia (a congenital deficiency of antithrombin III).

(b) *Classification.* Class II (performance standards).

[45 FR 60609, Sept. 12, 1980]

**§ 864.7100 Red blood cell enzyme assay.**

(a) *Identification.* Red blood cell enzyme assay is a device used to measure the activity in red blood cells of clinically important enzymatic reactions and their products, such as pyruvate kinase or 2,3-diphosphoglycerate. A red blood cell enzyme assay is used to determine the enzyme defects responsible for a patient's hereditary hemolytic anemia.

(b) *Classification.* Class II (performance standards).

[45 FR 60610, Sept. 12, 1980]

**§ 864.7140 Activated whole blood clotting time tests.**

(a) *Identification.* An activated whole blood clotting time tests is a device, used to monitor heparin therapy for the treatment of venous thrombosis or pulmonary embolism by measuring the coagulation time of whole blood.

(b) *Classification.* Class II (performance standards).

[45 FR 60611, Sept. 12, 1980]

**§ 864.7250 Erythropoietin assay.**

(a) *Identification.* A erythropoietin assay is a device that measures the concentration of erythropoietin (an enzyme that regulates the production of red blood cells) in serum or urine. This assay provides diagnostic information for the evaluation of erythrocytosis (increased total red cell mass) and anemia.

(b) *Classification.* Class II. The special control for this device is FDA’s “Document for Special Controls for Erythropoietin Assay Premarket Notification (510(k)s).”

[45 FR 60612, Sept. 12, 1980, as amended at 52 FR 17733, May 11, 1987; 65 FR 17144, Mar. 31, 2000]

**§ 864.7275 Euglobulin lysis time tests.**

(a) *Identification.* A euglobulin lysis time test is a device that measures the length of time required for the lysis (dissolution) of a clot formed from fibrinogen in the euglobulin fraction (that fraction of the plasma responsible for the formation of plasmin, a clot lysing enzyme). This test evaluates natural fibrinolysis (destruction of a blood clot after bleeding has been arrested). The test also will detect accelerated fibrinolysis.

(b) *Classification.* Class II (special controls). The device is exempt from the premarket notification procedures in subpart E of part 807 of this chapter subject to the limitations in § 864.9.

[45 FR 60612, Sept. 12, 1980, as amended at 84 FR 71799, Dec. 30, 2019]

**§ 864.7280 Factor V Leiden DNA mutation detection systems.**

(a) *Identification.* Factor V Leiden deoxyribonucleic acid (DNA) mutation detection systems are devices that consist of different reagents and instru-

ments which include polymerase chain reaction (PCR) primers, hybridization matrices, thermal cyclers, imagers, and software packages. The detection of the Factor V Leiden mutation aids in the diagnosis of patients with suspected thrombophilia.

(b) *Classification.* Class II (special controls). The special control is FDA’s guidance entitled “Class II Special Controls Guidance Document: Factor V Leiden DNA Mutation Detection Systems.” (See § 864.1(d) for the availability of this guidance document.)

[69 FR 12273, Mar. 16, 2004]

**§ 864.7290 Factor deficiency test.**

(a) *Identification.* A factor deficiency test is a device used to diagnose specific coagulation defects, to monitor certain types of therapy, to detect coagulation inhibitors, and to detect a carrier state (a person carrying both a recessive gene for a coagulation factor deficiency such as hemophilia and the corresponding normal gene).

(b) *Classification.* Class II (performance standards).

[45 FR 60613, Sept. 12, 1980]

**§ 864.7300 Fibrin monomer paracoagulation test.**

(a) *Identification.* A fibrin monomer paracoagulation test is a device used to detect fibrin monomer in the diagnosis of disseminated intravascular coagulation (nonlocalized clotting within a blood vessel) or in the differential diagnosis between disseminated intravascular coagulation and primary fibrinolysis (dissolution of the fibrin in a blood clot).

(b) *Classification.* Class II (special controls). The device is exempt from the premarket notification procedures in subpart E of part 807 of this chapter subject to the limitations in § 864.9. The special control for this device is FDA’s “In Vitro Diagnostic Fibrin Monomer Paracoagulation Test.” See § 864.1(d) for information on obtaining this document.

[45 FR 60614, Sept. 12, 1980, as amended at 52 FR 17733, May 11, 1987; 65 FR 17144, Mar. 31, 2000, 84 FR 71799, Dec. 30, 2019]

**§ 864.7320 Fibrinogen/fibrin degradation products assay.**

(a) *Identification.* A fibrinogen/fibrin degradation products assay is a device used to detect and measure fibrinogen degradation products and fibrin degradation products (protein fragments produced by the enzymatic action of plasmin on fibrinogen and fibrin) as an aid in detecting the presence and degree of intravascular coagulation and fibrinolysis (the dissolution of the fibrin in a blood clot) and in monitoring therapy for disseminated intravascular coagulation (nonlocalized clotting in the blood vessels).

(b) *Classification.* Class II (performance standards).

[45 FR 60615, Sept. 12, 1980]

**§ 864.7340 Fibrinogen determination system.**

(a) *Identification.* A fibrinogen determination system is a device that consists of the instruments, reagents, standards, and controls used to determine the fibrinogen levels in disseminated intravascular coagulation (nonlocalized clotting within the blood vessels) and primary fibrinolysis (the dissolution of fibrin in a blood clot).

(b) *Classification.* Class II (special controls). A control or fibrinogen standard intended for use with a fibrinogen determination system is exempt from the premarket notification procedures in subpart E of part 807 of this chapter subject to the limitations in § 864.9.

[45 FR 60615, Sept. 12, 1980, as amended at 84 FR 71799, Dec. 30, 2019]

**§ 864.7360 Erythrocytic glucose-6-phosphate dehydrogenase assay.**

(a) *Identification.* An erythrocytic glucose-6-phosphate dehydrogenase assay is a device used to measure the activity of the enzyme glucose-6-phosphate dehydrogenase or of glucose-6-phosphate dehydrogenase isoenzymes. The results of this assay are used in the diagnosis and treatment of nonspherocytic congenital hemolytic anemia or drug-induced hemolytic anemia associated with a glucose-6-phosphate dehydrogenase deficiency. This generic device includes assays based on fluorescence, electrophoresis,

methemoglobin reduction, catalase inhibition, and ultraviolet kinetics.

(b) *Classification.* Class II (performance standards).

[45 FR 60616, Sept. 12, 1980]

**§ 864.7375 Glutathione reductase assay.**

(a) *Identification.* A glutathione reductase assay is a device used to determine the activity of the enzyme glutathione reductase in serum, plasma, or erythrocytes by such techniques as fluorescence and photometry. The results of this assay are used in the diagnosis of liver disease, glutathione reductase deficiency, or riboflavin deficiency.

(b) *Classification.* Class II (special controls). The device is exempt from the premarket notification procedures in subpart E of part 807 of this chapter subject to the limitations in § 864.9.

[45 FR 60616, Sept. 12, 1980, as amended at 84 FR 71799, Dec. 30, 2019]

**§ 864.7400 Hemoglobin A<sub>2</sub> assay.**

(a) *Identification.* A hemoglobin A<sub>2</sub> assay is a device used to determine the hemoglobin A<sub>2</sub> content of human blood. The measurement of hemoglobin A<sub>2</sub> is used in the diagnosis of the thalassemias (hereditary hemolytic anemias characterized by decreased synthesis of one or more types of hemoglobin polypeptide chains).

(b) *Classification.* Class II (performance standards).

[45 FR 60617, Sept. 12, 1980]

**§ 864.7415 Abnormal hemoglobin assay.**

(a) *Identification.* An abnormal hemoglobin assay is a device consisting of the reagents, apparatus, instrumentation, and controls necessary to isolate and identify abnormal genetically determined hemoglobin types.

(b) *Classification.* Class II (special controls). A control intended for use with an abnormal hemoglobin assay is exempt from the premarket notification procedures in subpart E of part 807 of this chapter subject to the limitations in § 864.9.

[45 FR 60618, Sept. 12, 1980, as amended at 84 FR 71799, Dec. 30, 2019]

## § 864.7425

### § 864.7425 Carboxyhemoglobin assay.

(a) *Identification.* A carboxyhemoglobin assay is a device used to determine the carboxyhemoglobin (the compound formed when hemoglobin is exposed to carbon monoxide) content of human blood as an aid in the diagnosis of carbon monoxide poisoning. This measurement may be made using methods such as spectroscopy, colorimetry, spectrophotometry, and gasometry.

(b) *Classification.* Class II (performance standards).

[45 FR 60619, Sept. 12, 1980]

### § 864.7440 Electrophoretic hemoglobin analysis system.

(a) *Identification.* An electrophoretic hemoglobin analysis system is a device that electrophoretically separates and identifies normal and abnormal hemoglobin types as an aid in the diagnosis of anemia or erythrocytosis (increased total red cell mass) due to a hemoglobin abnormality.

(b) *Classification.* Class II (performance standards).

[45 FR 60620, Sept. 12, 1980]

### § 864.7455 Fetal hemoglobin assay.

(a) *Identification.* A fetal hemoglobin assay is a device that is used to determine the presence and distribution of fetal hemoglobin (hemoglobin F) in red cells or to measure the amount of fetal hemoglobin present. The assay may be used to detect fetal red cells in the maternal circulation or to detect the elevated levels of fetal hemoglobin exhibited in cases of hemoglobin abnormalities such as thalassemia (a hereditary hemolytic anemia characterized by a decreased synthesis of one or more types of hemoglobin polypeptide chains). The hemoglobin determination may be made by methods such as electrophoresis, alkali denaturation, column chromatography, or radial immunodiffusion.

(b) *Classification.* Class II (special controls). A fetal hemoglobin stain intended for use with a fetal hemoglobin assay is exempt from the premarket notification procedures in subpart E of

## 21 CFR Ch. I (4-1-20 Edition)

part 807 of this chapter subject to the limitations in § 864.9.

[45 FR 60620, Sept. 12, 1980, as amended at 84 FR 71799, Dec. 30, 2019]

### § 864.7470 Glycosylated hemoglobin assay.

(a) *Identification.* A glycosylated hemoglobin assay is a device used to measure the glycosylated hemoglobins (A<sub>1a</sub>, A<sub>1b</sub>, and A<sub>1c</sub>) in a patient's blood by a column chromatographic procedure. Measurement of glycosylated hemoglobin is used to assess the level of control of a patient's diabetes and to determine the proper insulin dosage for a patient. Elevated levels of glycosylated hemoglobin indicate uncontrolled diabetes in a patient.

(b) *Classification.* Class II (performance standards).

[45 FR 60621, Sept. 12, 1980]

### § 864.7490 Sulfhemoglobin assay.

(a) *Identification.* A sulfhemoglobin assay is a device consisting of the reagents, calibrators, controls, and instrumentation used to determine the sulfhemoglobin (a compound of sulfur and hemoglobin) content of human blood as an aid in the diagnosis of sulfhemoglobinemia (presence of sulfhemoglobin in the blood due to drug administration or exposure to a poison). This measurement may be made using methods such as spectroscopy, colorimetry, spectrophotometry, or gasometry.

(b) *Classification.* Class II (performance standards).

[45 FR 60621, Sept. 12, 1980]

### § 864.7500 Whole blood hemoglobin assays.

(a) *Identification.* A whole blood hemoglobin assay is a device consisting of reagents, calibrators, controls, or photometric or spectrophotometric instrumentation used to measure the hemoglobin content of whole blood for the detection of anemia. This generic device category does not include automated hemoglobin systems.

(b) *Classification.* Class II (special controls). An acid hematin intended for use with whole blood hemoglobin assays is exempt from the premarket notification procedures in subpart E of

part 807 of this chapter subject to the limitations in § 864.9.

[45 FR 60622, Sept. 12, 1980, as amended at 84 FR 71799, Dec. 30, 2019]

**§ 864.7525 Heparin assay.**

(a) *Identification.* A heparin assay is a device used to determine the level of the anticoagulant heparin in the patient's circulation. These assays are quantitative clotting time procedures using the effect of heparin on activated coagulation factor X (Stuart factor) or procedures based on the neutralization of heparin by protamine sulfate (a protein that neutralizes heparin).

(b) *Classification.* Class II (performance standards).

[45 FR 60623, Sept. 12, 1980]

**§ 864.7660 Leukocyte alkaline phosphatase test.**

(a) *Identification.* A leukocyte alkaline phosphatase test is a device used to identify the enzyme leukocyte alkaline phosphatase in neutrophilic granulocytes (granular leukocytes stainable by neutral dyes). The cytochemical identification of alkaline phosphatase depends on the formation of blue granules in cells containing alkaline phosphatase. The results of this test are used to differentiate chronic granulocytic leukemia (a malignant disease characterized by excessive overgrowth of granulocytes in the bone marrow) and reactions that resemble true leukemia, such as those occurring in severe infections and polycythemia (increased total red cell mass).

(b) *Classification.* Class I (general controls). This device is exempt from the premarket notification procedures in subpart E of part 807 of this chapter subject to the limitations in § 864.9.

[45 FR 60623, Sept. 12, 1980, as amended at 59 FR 63007, Dec. 7, 1994; 66 FR 38790, July 25, 2001]

**§ 864.7675 Leukocyte peroxidase test.**

(a) *Identification.* A leukocyte peroxidase test is a device used to distinguish certain myeloid cells derived from the bone marrow, i.e., neutrophils, eosinophils, and monocytes, from lymphoid cells of the lymphatic system and erythroid cells of the red blood cell series on the basis of their peroxidase

activity as evidenced by staining. The results of this test are used in the differential diagnosis of the leukemias.

(b) *Classification.* Class I (general controls). This device is exempt from the premarket notification procedures in subpart E of part 807 of this chapter subject to the limitations in § 864.9.

[45 FR 60624, Sept. 12, 1980, as amended at 59 FR 63007, Dec. 7, 1994; 66 FR 38790, July 25, 2001]

**§ 864.7695 Platelet factor 4 radioimmunoassay.**

(a) *Identification.* A platelet factor 4 radioimmunoassay is a device used to measure the level of platelet factor 4, a protein released during platelet activation by radioimmunoassay. This device measures platelet activation, which may indicate a coagulation disorder, such as myocardial infarction or coronary artery disease.

(b) *Classification.* Class II (performance standards).

[45 FR 60625, Sept. 12, 1980; 46 FR 14890, Mar. 3, 1981]

**§ 864.7720 Prothrombin consumption test.**

(a) *Identification.* A prothrombin consumption tests is a device that measures the patient's capacity to generate thromboplastin in the coagulation process. The test also is an indirect indicator of qualitative or quantitative platelet abnormalities. It is a screening test for thrombocytopenia (decreased number of blood platelets) and hemophilia A and B.

(b) *Classification.* Class II (special controls). The device is exempt from the premarket notification procedures in subpart E of part 807 of this chapter subject to the limitations in § 864.9.

[45 FR 60625, Sept. 12, 1980, as amended at 84 FR 71800, Dec. 30, 2019]

**§ 864.7735 Prothrombin-proconvertin test and thrombotest.**

(a) *Identification.* The prothrombin-proconvertin test and thrombotest are devices used in the regulation of coumarin therapy (administration of a

## § 864.7750

coumarin anticoagulant such as sodium warfarin in the treatment of venous thrombosis and pulmonary embolism) and as a diagnostic test in conjunction with, or in place of, the Quick prothrombin time test to detect coagulation disorders.

(b) *Classification*. Class II (special controls). The device is exempt from the premarket notification procedures in subpart E of part 807 of this chapter subject to the limitations in § 864.9.

[45 FR 60626, Sept. 12, 1980, as amended at 84 FR 71800, Dec. 30, 2019]

### § 864.7750 Prothrombin time test.

(a) *Identification*. A prothrombin time test is a device used as a general screening procedure for the detection of possible clotting factor deficiencies in the extrinsic coagulation pathway, which involves the reaction between coagulation factors III and VII, and to monitor patients receiving coumarin therapy (the administration of one of the coumarin anticoagulants in the treatment of venous thrombosis or pulmonary embolism).

(b) *Classification*. Class II (performance standards).

[45 FR 60626, Sept. 12, 1980]

### § 864.7825 Sickle cell test.

(a) *Identification*. A sickle cell test is a device used to determine the sickle cell hemoglobin content of human blood to detect sickle cell trait or sickle cell diseases.

(b) *Classification*. Class II (performance standards).

[45 FR 60627, Sept. 12, 1980]

### § 864.7875 Thrombin time test.

(a) *Identification*. A thrombin time test is a device used to measure fibrinogen concentration and detect fibrin or fibrinogen split products for the evaluation of bleeding disorders.

(b) *Classification*. Class II (performance standards).

[45 FR 60628, Sept. 12, 1980]

### § 864.7900 Thromboplastin generation test.

(a) *Identification*. A thromboplastin generation test is a device used to de-

## 21 CFR Ch. I (4–1–20 Edition)

tect and identify coagulation factor deficiencies and coagulation inhibitors.

(b) *Classification*. Class I (general controls). This device is exempt from the premarket notification procedures in subpart E of part 807 of this chapter subject to the limitations in § 864.9.

[45 FR 60628, Sept. 12, 1980, as amended at 59 FR 63007, Dec. 7, 1994; 66 FR 38790, July 25, 2001]

### § 864.7925 Partial thromboplastin time tests.

(a) *Identification*. A partial thromboplastin time test is a device used for primary screening for coagulation abnormalities, for evaluation of the effect of therapy on procoagulant disorders, and as an assay for coagulation factor deficiencies of the intrinsic coagulation pathway.

(b) *Classification*. Class II (performance standards).

[45 FR 60629, Sept. 12, 1980]

## Subpart I—Hematology Reagents

### § 864.8100 Bothrops atrox reagent.

(a) *Identification*. A Bothrops atrox reagent is a device made from snake venom and used to determine blood fibrinogen levels to aid in the evaluation of disseminated intravascular coagulation (nonlocalized clotting in the blood vessels) in patients receiving heparin therapy (the administration of the anticoagulant heparin in the treatment of thrombosis) or as an aid in the classification of dysfibrinogenemia (presence in the plasma of functionally defective fibrinogen).

(b) *Classification*. Class II (performance standards).

[45 FR 60629, Sept. 12, 1980]

### § 864.8150 Calibrator for cell indices.

(a) *Identification*. A calibrator for cell indices is a device that approximates whole blood or certain blood cells and that is used to set an instrument intended to measure mean cell volume (MCV), mean corpuscular hemoglobin (MCH), and mean corpuscular hemoglobin concentration (MCHC), or other cell indices. It is a suspension of particles or cells whose size, shape, concentration, and other characteristics

## Food and Drug Administration, HHS

## § 864.8625

have been precisely and accurately determined.

(b) *Classification.* Class II (special controls). The device is exempt from the premarket notification procedures in subpart E of part 807 of this chapter subject to the limitations in § 864.9.

[45 FR 60631, Sept. 12, 1980, as amended at 84 FR 71800, Dec. 30, 2019]

### § 864.8165 Calibrator for hemoglobin or hematocrit measurement.

(a) *Identification.* A calibrator for hemoglobin or hematocrit measurement is a device that approximates whole blood, red blood cells, or a hemoglobin derivative and that is used to set instruments intended to measure hemoglobin, the hematocrit, or both. It is a material whose characteristics have been precisely and accurately determined.

(b) *Classification.* Class II (special controls). The device is exempt from the premarket notification procedures in subpart E of part 807 of this chapter subject to the limitations in § 864.9.

[45 FR 60632, Sept. 12, 1980, as amended at 84 FR 71800, Dec. 30, 2019]

### § 864.8175 Calibrator for platelet counting.

(a) *Identification.* A calibrator for platelet counting is a device that resembles platelets in plasma or whole blood and that is used to set a platelet counting instrument. It is a suspension of particles or cells whose size, shape concentration, and other characteristics have been precisely and accurately determined.

(b) *Classification.* Class II (special controls). The device is exempt from the premarket notification procedures in subpart E of part 807 of this chapter subject to the limitations in § 864.9.

[45 FR 60633, Sept. 12, 1980, as amended at 84 FR 71800, Dec. 30, 2019]

### § 864.8185 Calibrator for red cell and white cell counting.

(a) *Identification.* A calibrator for red cell and white cell counting is a device that resembles red or white blood cells and that is used to set instruments intended to count red cells, white cells, or both. It is a suspension of particles or cells whose size, shape, concentra-

tion, and other characteristics have been precisely and accurately determined.

(b) *Classification.* Class II (special controls). The device is exempt from the premarket notification procedures in subpart E of part 807 of this chapter subject to the limitations in § 864.9.

[45 FR 60634, Sept. 12, 1980, as amended at 84 FR 71800, Dec. 30, 2019]

### § 864.8200 Blood cell diluent.

(a) *Identification.* A blood cell diluent is a device used to dilute blood for further testing, such as blood cell counting.

(b) *Classification.* Class I (general controls). This device is exempt from the premarket notification procedures in subpart E of part 807 of this chapter subject to the limitations in § 864.9.

[45 FR 60635, Sept. 12, 1980, as amended at 54 FR 25045, June 12, 1989; 66 FR 38790, July 25, 2001]

### § 864.8500 Lymphocyte separation medium.

(a) *Identification.* A lymphocyte separation medium is a device used to isolate lymphocytes from whole blood.

(b) *Classification.* Class I (general controls). This device is exempt from the premarket notification procedures in subpart E of part 807 of this chapter subject to the limitations in § 864.9.

[45 FR 60636, Sept. 12, 1980, as amended at 59 FR 63007, Dec. 7, 1994; 66 FR 38790, July 25, 2001]

### § 864.8540 Red cell lysing reagent.

(a) *Identification.* A red cell lysing reagent is a device used to lyse (destroy) red blood cells for hemoglobin determinations or aid in the counting of white blood cells.

(b) *Classification.* Class I (general controls). This device is exempt from the premarket notification procedures in subpart E of part 807 of this chapter subject to the limitations in § 864.9.

[45 FR 60636, Sept. 12, 1980, as amended at 54 FR 25045, June 12, 1989; 66 FR 38790, July 25, 2001]

### § 864.8625 Hematology quality control mixture.

(a) *Identification.* A hematology quality control mixture is a device used to

## § 864.8950

ascertain the accuracy and precision of manual, semiautomated, and automated determinations of cell parameters such as white cell count (WBC), red cell count (RBC), platelet count (PLT), hemoglobin, hematocrit (HCT), mean corpuscular volume (MCV), mean corpuscular hemoglobin (MCH), and mean corpuscular hemoglobin concentration (MCHC).

(b) *Classification*. Class II (special controls). Except when intended for use in blood components, the device is exempt from the premarket notification procedures in subpart E of part 807 of this chapter subject to the limitations in § 864.9.

[45 FR 60637, Sept. 12, 1980, as amended at 84 FR 71800, Dec. 30, 2019]

## § 864.8950 Russell viper venom reagent.

(a) *Identification*. Russell viper venom reagent is a device used to determine the cause of an increase in the prothrombin time.

(b) *Classification*. Class I (general controls).

[45 FR 60637, Sept. 12, 1980]

## Subpart J—Products Used In Establishments That Manufacture Blood and Blood Products

### § 864.9050 Blood bank supplies.

(a) *Identification*. Blood bank supplies are general purpose devices intended for in vitro use in blood banking. This generic type of device includes products such as blood bank pipettes, blood grouping slides, blood typing tubes, blood typing racks, and cold packs for antisera reagents. The device does not include articles that are licensed by the Center for Biologics Evaluation and Research of the Food and Drug Administration.

(b) *Classification*. Class I (general controls).

[45 FR 60638, Sept. 12, 1980, as amended at 53 FR 11253, Apr. 6, 1988]

### § 864.9100 Empty container for the collection and processing of blood and blood components.

(a) *Identification*. An empty container for the collection and processing of

## 21 CFR Ch. I (4–1–20 Edition)

blood and blood components is a device intended for medical purposes that is an empty plastic bag or plastic or glass bottle used to collect, store, or transfer blood and blood components for further processing.

(b) *Classification*. Class II (performance standards).

[45 FR 60638, Sept. 12, 1980]

### § 864.9125 Vacuum-assisted blood collection system.

(a) *Identification*. A vacuum-assisted blood collection system is a device intended for medical purposes that uses a vacuum to draw blood for subsequent reinfusion.

(b) *Classification*. Class I (general controls). The manual device is exempt from the premarket notification procedures in subpart E of part 807 of this chapter subject to § 864.9.

[45 FR 60639, Sept. 12, 1980, as amended at 65 FR 2310, Jan. 14, 2000]

### § 864.9145 Processing system for frozen blood.

(a) *Identification*. A processing system for frozen blood is a device used to glycerolize red blood cells prior to freezing to minimize hemolysis (disruption of the red cell membrane accompanied by the release of hemoglobin) due to freezing and thawing of red blood cells and to deglycerolize and wash thawed cells for subsequent reinfusion.

(b) *Classification*. Class II (performance standards).

[45 FR 60639, Sept. 12, 1980]

### § 864.9160 Blood group substances of nonhuman origin for in vitro diagnostic use.

(a) *Identification*. Blood group substances of nonhuman origin for in vitro diagnostic use are materials, such as blood group specific substances prepared from nonhuman sources (e.g., pigs, cows, and horses) used to detect, identify, or neutralize antibodies to various human blood group antigens. This generic type of device does not include materials that are licensed by the Center for Biologics Evaluation and Research of the Food and Drug Administration.



## Food and Drug Administration, HHS

## § 864.9205

(b) *Classification*. Class II (special controls). The device is exempt from the premarket notification procedures in subpart E of part 807 of this chapter subject to § 864.9.

[45 FR 60640, Sept. 12, 1980, as amended at 53 FR 11253, Apr. 6, 1988; 63 FR 59225, Nov. 3, 1998]

### § 864.9165 Blood establishment computer software and accessories.

(a) *Identification*. Blood establishment computer software (BECS) is a device used in the manufacture of blood and blood components to assist in the prevention of disease in humans by identifying ineligible donors, by preventing the release of unsuitable blood and blood components for transfusion or for further manufacturing into products for human treatment or diagnosis, by performing compatibility testing between donor and recipient, or by performing positive identification of patients and blood components at the point of transfusion to prevent transfusion reactions. This generic type of device may include a BECS accessory, a device intended for use with BECS to augment the performance of the BECS or to expand or modify its indications for use.

(b) *Classification*. Class II (special controls). The special controls for these devices are:

(1) Software performance and functional requirements including detailed design specifications (*e.g.*, algorithms or control characteristics, alarms, device limitations, and safety requirements).

(2) Verification and validation testing and hazard analysis must be performed.

(3) Labeling must include:

(i) Software limitations;

(ii) Unresolved anomalies, annotated with an explanation of the impact on safety or effectiveness;

(iii) Revision history; and

(iv) Hardware and peripheral specifications.

(4) Traceability matrix must be performed.

(5) Performance testing to ensure the safety and effectiveness of the system must be performed, including when adding new functional requirements

(*e.g.*, electrical safety, electromagnetic compatibility, or wireless coexistence).

[83 FR 23217, June 18, 2018]

### § 864.9175 Automated blood grouping and antibody test system.

(a) *Identification*. An automated blood grouping and antibody test system is a device used to group erythrocytes (red blood cells) and to detect antibodies to blood group antigens.

(b) *Classification*. Class II (performance standards).

[45 FR 60641, Sept. 12, 1980]

### § 864.9185 Blood grouping view box.

(a) *Identification*. A blood grouping view box is a device with a glass or plastic viewing surface, which may be illuminated and heated, that is used to view cell reactions in antigen-antibody testing.

(b) *Classification*. Class I (general controls). The device is exempt from the premarket notification procedures in subpart E of part 807 of this chapter subject to § 864.9.

[45 FR 60641, Sept. 12, 1980, as amended at 65 FR 2310, Jan. 14, 2000]

### § 864.9195 Blood mixing devices and blood weighing devices.

(a) *Identification*. A blood mixing device is a device intended for medical purposes that is used to mix blood or blood components by agitation. A blood weighing device is a device intended for medical purposes that is used to weigh blood or blood components as they are collected.

(b) *Classification*. Class I (general controls). The manual device is exempt from the premarket notification procedures in subpart E of part 807 of this chapter subject to § 864.9.

[45 FR 60642, Sept. 12, 1980, as amended at 65 FR 2310, Jan. 14, 2000]

### § 864.9205 Blood and plasma warming device.

(a) *Nonelectromagnetic blood or plasma warming device*—(1) *Identification*. A nonelectromagnetic blood and plasma warming device is a device that warms blood or plasma, by means other than electromagnetic radiation, prior to administration.

**§ 864.9225**

(2) *Classification.* Class II (performance standards).

(b) *Electromagnetic blood and plasma warming device—(1) Identification.* An electromagnetic blood and plasma warming device is a device that employs electromagnetic radiation (radiowaves or microwaves) to warm a bag or bottle of blood or plasma prior to administration.

(2) *Classification.* Class III (premarket approval).

(c) *Date PMA or notice of completion of a PDP is required.* No effective date has been established of the requirement for premarket approval for the device described in paragraph (b)(1). See § 864.3.

[45 FR 60642, Sept. 12, 1980, as amended at 52 FR 17733, May 11, 1987]

**§ 864.9225 Cell-freezing apparatus and reagents for in vitro diagnostic use.**

(a) *Identification.* Cell-freezing apparatus and reagents for in vitro diagnostic use are devices used to freeze human red blood cells for in vitro diagnostic use.

(b) *Classification.* Class I (general controls). The device is exempt from the premarket notification procedures in subpart E of part 807 of this chapter subject to § 864.9.

[45 FR 60643, Sept. 12, 1980, as amended at 65 FR 2310, Jan. 14, 2000]

**§ 864.9245 Automated blood cell separator.**

(a) *Identification.* An automated blood cell separator is a device that uses a centrifugal or filtration separation principle to automatically withdraw whole blood from a donor, separate the whole blood into blood components, collect one or more of the blood components, and return to the donor the remainder of the whole blood and blood components. The automated blood cell separator device is intended for routine collection of blood and blood components for transfusion or further manufacturing use.

(b) *Classification.* Class II (special controls). The special control for this device is a guidance for industry and FDA staff entitled “Class II Special Controls Guidance Document: Automated Blood Cell Separator Device Op-

**21 CFR Ch. I (4–1–20 Edition)**

erating by Centrifugal or Filtration Separation Principle.”

[72 FR 67644, Nov. 30, 2007]

**§ 864.9275 Blood bank centrifuge for in vitro diagnostic use.**

(a) *Identification.* A blood bank centrifuge for in vitro diagnostic use is a device used only to separate blood cells for further diagnostic testing.

(b) *Classification.* Class I (general controls). The device is exempt from the premarket notification procedures in subpart E of part 807 of this chapter subject to § 864.9.

[45 FR 60645, Sept. 12, 1980, as amended at 65 FR 2310, Jan. 14, 2000]

**§ 864.9285 Automated cell-washing centrifuge for immuno-hematology.**

(a) *Identification.* An automated cell-washing centrifuge for immuno-hematology is a device used to separate and prepare cells and sera for further in vitro diagnostic testing.

(b) *Classification.* Class II (performance standards).

[45 FR 60646, Sept. 12, 1980]

**§ 864.9300 Automated Coombs test systems.**

(a) *Identification.* An automated Coombs test system is a device used to detect and identify antibodies in patient sera or antibodies bound to red cells. The Coombs test is used for the diagnosis of hemolytic disease of the newborn, and autoimmune hemolytic anemia. The test is also used in crossmatching and in investigating transfusion reactions and drug-induced red cell sensitization.

(b) *Classification.* Class II (performance standards).

[45 FR 60646, Sept. 12, 1980]

**§ 864.9320 Copper sulfate solution for specific gravity determinations.**

(a) *Identification.* A copper sulfate solution for specific gravity determinations is a device used to determine whether the hemoglobin content of a potential donor’s blood meets the required level (12.5 grams per 100 milliliters of blood for women and 13.5 grams per 100 milliliters of blood for men).

## Food and Drug Administration, HHS

## § 864.9750

(b) *Classification*. Class I (general controls). The device is exempt from the premarket notification procedures in subpart E of part 807 of this chapter subject to § 864.9.

[45 FR 60647, Sept. 12, 1980, as amended at 65 FR 2310, Jan. 14, 2000]

### § 864.9400 Stabilized enzyme solution.

(a) *Identification*. A stabilized enzyme solution is a reagent intended for medical purposes that is used to enhance the reactivity of red blood cells with certain antibodies, including antibodies that are not detectable by other techniques. These enzyme solutions include papain, bromelin, ficin, and trypsin.

(b) *Classification*. Class II (special controls). The device is exempt from the premarket notification procedures in subpart E of part 807 of this chapter subject to the limitations in § 864.9.

[45 FR 60647, Sept. 12, 1980, as amended at 84 FR 71800, Dec. 30, 2019]

### § 864.9550 Lectins and protectins.

(a) *Identification*. Lectins and protectins are proteins derived from plants and lower animals that cause cell agglutination in the presence of certain antigens. These substances are used to detect blood group antigens for in vitro diagnostic purposes.

(b) *Classification*. Class II (special controls). The device is exempt from the premarket notification procedures in subpart E of part 807 of this chapter subject to § 864.9.

[45 FR 60648, Sept. 12, 1980, as amended at 63 FR 59226, Nov. 3, 1998]

### § 864.9575 Environmental chamber for storage of platelet concentrate.

(a) *Identification*. An environmental chamber for storage of platelet concentrate is a device used to hold platelet-rich plasma within a preselected temperature range.

(b) *Classification*. Class II (special controls). The device is exempt from the premarket notification procedures in subpart E of part 807 of this chapter subject to § 864.9.

[45 FR 60648, Sept. 12, 1980, as amended at 63 FR 59226, Nov. 3, 1998]

### § 864.9600 Potentiating media for in vitro diagnostic use.

(a) *Identification*. Potentiating media for in vitro diagnostic use are media, such as bovine albumin, that are used to suspend red cells and to enhance cell reactions for antigen-antibody testing.

(b) *Classification*. Class II (special controls). The device is exempt from the premarket notification procedures in subpart E of part 807 of this chapter subject to § 864.9.

[45 FR 60649, Sept. 12, 1980, as amended at 63 FR 59226, Nov. 3, 1998]

### § 864.9650 Quality control kit for blood banking reagents.

(a) *Identification*. A quality control kit for blood banking reagents is a device that consists of sera, cells, buffers, and antibodies used to determine the specificity, potency, and reactivity of the cells and reagents used for blood banking.

(b) *Classification*. Class II (performance standards).

[45 FR 60649, Sept. 12, 1980]

### § 864.9700 Blood storage refrigerator and blood storage freezer.

(a) *Identification*. A blood storage refrigerator and a blood storage freezer are devices intended for medical purposes that are used to preserve blood and blood products by storing them at cold or freezing temperatures.

(b) *Classification*. Class II (special controls). The device is exempt from the premarket notification procedures in subpart E of part 807 of this chapter subject to § 864.9.

[45 FR 60650, Sept. 12, 1980, as amended at 63 FR 59226, Nov. 3, 1998]

### § 864.9750 Heat-sealing device.

(a) *Identification*. A heat-sealing device is a device intended for medical purposes that uses heat to seal plastic bags containing blood or blood components.

(b) *Classification*. Class I (general controls). The device is exempt from the premarket notification procedures in subpart E of part 807 of this chapter subject to § 864.9.

[45 FR 60650, Sept. 12, 1980, as amended at 65 FR 2311, Jan. 14, 2000]

§ 864.9875

§ 864.9875 Transfer set.

(a) Identification. A transfer set is a device intended for medical purposes that consists of a piece of tubing with suitable adaptors used to transfer blood or plasma from one container to another.

(b) Classification. Class II (performance standards).

[45 FR 60651, Sept. 12, 1980]

Subpart K—Products Used In Establishments That Manufacture Human Cells, Tissues, and Cellular and Tissue-Based Products (HCT/Ps)

§ 864.9900 Cord blood processing system and storage container.

(a) Identification. A cord blood processing system and storage container is a device intended for use in the processing and the storage of cord blood. This device is a functionally closed processing system that includes containers, other soft goods, and a centrifugation system for cord blood concentration, and a final container for the cryopreservation and the storage of a cord blood product.

(b) Classification. Class II (special controls). The special control for this device is FDA's guidance document entitled "Class II Special Controls Guidance Document: Cord Blood Processing System and Storage Container." For the availability of this guidance document, see § 864.1(d).

[72 FR 4638, Feb. 1, 2007]

PART 866—IMMUNOLOGY AND MICROBIOLOGY DEVICES

Subpart A—General Provisions

Sec.

- 866.1 Scope.
866.3 Effective dates of requirement for pre-market approval.
866.9 Limitations of exemptions from section 510(k) of the Federal Food, Drug, and Cosmetic Act (the act).

Subpart B—Diagnostic Devices

- 866.1620 Antimicrobial susceptibility test disc.
866.1640 Antimicrobial susceptibility test powder.

21 CFR Ch. I (4-1-20 Edition)

- 866.1645 Fully automated short-term incubation cycle antimicrobial susceptibility system.
866.1700 Culture medium for antimicrobial susceptibility tests.

Subpart C—Microbiology Devices

- 866.2050 Staphylococcal bacteriophage typing.
866.2120 Anaerobic chamber.
866.2160 Coagulase plasma.
866.2170 Automated colony counter.
866.2180 Manual colony counter.
866.2190 Automated image assessment system for microbial colonies on solid culture media.
866.2300 Multipurpose culture medium.
866.2320 Differential culture medium.
866.2330 Enriched culture medium.
866.2350 Microbiological assay culture medium.
866.2360 Selective culture medium.
866.2390 Transport culture medium.
866.2410 Culture medium for pathogenic Neisseria spp.
866.2420 Oxidase screening test for gonorrhea.
866.2440 Automated medium dispensing and stacking device.
866.2450 Supplement for culture media.
866.2480 Quality control kit for culture media.
866.2500 Microtiter diluting and dispensing device.
866.2540 Microbiological incubator.
866.2560 Microbial growth monitor.
866.2580 Gas-generating device.
866.2600 Wood's fluorescent lamp.
866.2660 Microorganism differentiation and identification device.
866.2680 Streptococcus spp. nucleic acid-based assay.
866.2850 Automated zone reader.
866.2900 Microbiological specimen collection and transport device.

Subpart D—Serological Reagents

- 866.3010 Acinetobacter calcoaceticus serological reagents.
866.3020 Adenovirus serological reagents.
866.3035 Arizona spp. serological reagents.
866.3040 Aspergillus spp. serological reagents.
866.3045 In vitro diagnostic device for Bacillus spp. detection.
866.3050 Beta-glucan serological assays.
866.3060 Blastomyces dermatitidis serological reagents.
866.3065 Bordetella spp. serological reagents.
866.3085 Brucella spp. serological reagents.
866.3110 Campylobacter fetus serological reagents.
866.3120 Chlamydia serological reagents.
866.3125 Citrobacter spp. serological reagents.
866.3130 Clostridium difficile toxin gene amplification assay.

- 866.3135 *Coccidioides immitis* serological reagents.
- 866.3140 *Corynebacterium* spp. serological reagents.
- 866.3145 Coxsackievirus serological reagents.
- 866.3165 *Cryptococcus neoformans* serological reagents.
- 866.3175 Cytomegalovirus serological reagents.
- 866.3200 *Echinococcus* spp. serological reagents.
- 866.3205 Echovirus serological reagents.
- 866.3210 Endotoxin assay.
- 866.3215 Device to detect and measure non-microbial analyte(s) in human clinical specimens to aid in assessment of patients with suspected sepsis.
- 866.3220 *Entamoeba histolytica* serological reagents.
- 866.3225 Enterovirus nucleic acid assay.
- 866.3235 Epstein-Barr virus serological reagents.
- 866.3240 Equine encephalomyelitis virus serological reagents.
- 866.3250 *Erysipelothrix rhusiopathiae* serological reagents.
- 866.3255 *Escherichia coli* serological reagents.
- 866.3270 *Flavobacterium* spp. serological reagents.
- 866.3280 *Francisella tularensis* serological reagents.
- 866.3290 Gonococcal antibody test (GAT).
- 866.3300 *Haemophilus* spp. serological reagents.
- 866.3305 Herpes simplex virus serological assays.
- 866.3309 Herpes virus nucleic acid-based cutaneous and mucocutaneous lesion panel.
- 866.3310 Hepatitis A virus (HAV) serological assays.
- 866.3320 *Histoplasma capsulatum* serological reagents.
- 866.3328 Influenza virus antigen detection test system.
- 866.3330 Influenza virus serological reagents.
- 866.3332 Reagents for detection of specific novel influenza A viruses.
- 866.3336 John Cunningham Virus serological reagents.
- 866.3340 *Klebsiella* spp. serological reagents.
- 866.3350 *Leptospira* spp. serological reagents.
- 866.3355 *Listeria* spp. serological reagents.
- 866.3360 Lymphocytic choriomeningitis virus serological reagents.
- 866.3361 Mass spectrometer system for clinical use for the identification of microorganisms.
- 866.3365 Multiplex nucleic acid assay for identification of microorganisms and resistance markers from positive blood cultures.
- 866.3370 *Mycobacterium tuberculosis* immunofluorescent reagents.
- 866.3372 Nucleic acid-based in vitro diagnostic devices for the detection of *Mycobacterium tuberculosis* complex in respiratory specimens.
- 866.3373 Nucleic acid-based in vitro diagnostic devices for the detection of *Mycobacterium tuberculosis* complex (MTB-complex) and the genetic mutations associated with MTB-complex antibiotic resistance in respiratory specimens.
- 866.3375 *Mycoplasma* spp. serological reagents.
- 866.3380 Mumps virus serological reagents.
- 866.3390 *Neisseria* spp. direct serological test reagents.
- 866.3395 Norovirus serological reagents.
- 866.3400 Parainfluenza virus serological reagents.
- 866.3402 Plasmodium species antigen detection assays.
- 866.3405 Poliovirus serological reagents.
- 866.3410 *Proteus* spp. (Weil-Felix) serological reagents.
- 866.3415 *Pseudomonas* spp. serological reagents.
- 866.3460 Rabiesvirus immunofluorescent reagents.
- 866.3470 Reovirus serological reagents.
- 866.3480 Respiratory syncytial virus serological reagents.
- 866.3490 Rhinovirus serological reagents.
- 866.3500 Rickettsia serological reagents.
- 866.3510 Rubella virus serological reagents.
- 866.3520 Rubella (measles) virus serological reagents.
- 866.3550 *Salmonella* spp. serological reagents.
- 866.3600 *Schistosoma* spp. serological reagents.
- 866.3630 *Serratia* spp. serological reagents.
- 866.3660 *Shigella* spp. serological reagents.
- 866.3680 *Sporothrix schenckii* serological reagents.
- 866.3700 *Staphylococcus aureus* serological reagents.
- 866.3720 *Streptococcus* spp. exoenzyme reagents.
- 866.3740 *Streptococcus* spp. serological reagents.
- 866.3780 *Toxoplasma gondii* serological reagents.
- 866.3820 *Treponema pallidum* nontreponemal test reagents.
- 866.3830 *Treponema pallidum* treponemal test reagents.
- 866.3850 *Trichinella spiralis* serological reagents.
- 866.3860 *Trichomonas vaginalis* nucleic acid assay.
- 866.3870 *Trypanosoma* spp. serological reagents.
- 866.3900 Varicella-zoster virus serological reagents.
- 866.3920 Assayed quality control material for clinical microbiology assays.
- 866.3930 *Vibrio cholerae* serological reagents.
- 866.3940 West Nile virus serological reagents.
- 866.3945 Dengue virus serological reagents.

- 866.3946 Dengue virus nucleic acid amplification test reagents.
- 866.3950 In vitro human immunodeficiency virus (HIV) drug resistance genotype assay.
- 866.3955 Human immunodeficiency virus (HIV) drug resistance genotyping assay using next generation sequencing technology.
- 866.3960 Nucleic acid-based device for the amplification, detection, and identification of microbial pathogens directly from whole blood specimens.
- 866.3970 Device to detect and identify microbial pathogen nucleic acids in cerebrospinal fluid.
- 866.3980 Respiratory viral panel multiplex nucleic acid assay.
- 866.3985 Device to detect and identify microorganisms and associated resistance marker nucleic acids directly in respiratory specimens.
- 866.3990 Gastrointestinal microorganism multiplex nucleic acid-based assay.
- 866.5160 *Beta-globulin* immunological test system.
- 866.5170 Breast milk immunological test system.
- 866.5180 Fecal calprotectin immunological test system.
- 866.5200 Carbonic anhydrase B and C immunological test system.
- 866.5210 Ceruloplasmin immunological test system.
- 866.5220 Cohn fraction II immunological test system.
- 866.5230 Colostrum immunological test system.
- 866.5240 Complement components immunological test system.
- 866.5250 Complement C<sub>1</sub> inhibitor (inactivator) immunological test system.
- 866.5260 Complement C<sub>3b</sub> inactivator immunological test system.
- 866.5270 C-reactive protein immunological test system.
- 866.5320 Properidin factor B immunological test system.
- 866.5330 Factor XIII, A, S, immunological test system.
- 866.5340 Ferritin immunological test system.
- 866.5350 Fibrinopeptide A immunological test system.
- 866.5360 Cohn fraction IV immunological test system.
- 866.5370 Cohn fraction V immunological test system.
- 866.5380 Free secretory component immunological test system.
- 866.5400 *Alpha-globulin* immunological test system.
- 866.5420 *Alpha-1-glycoproteins* immunological test system.
- 866.5425 *Alpha-2-glycoproteins* immunological test system.
- 866.5430 *Beta-2-glycoprotein I* immunological test system.
- 866.5440 *Beta-2-glycoprotein III* immunological test system.
- 866.5460 Haptoglobin immunological test system.
- 866.5470 Hemoglobin immunological test system.
- 866.5490 Hemopexin immunological test system.
- 866.5500 Hypersensitivity pneumonitis immunological test system.
- 866.5510 Immunoglobulins A, G, M, D, and E immunological test system.
- 866.5520 Immunoglobulin G (Fab fragment specific) immunological test system.
- 866.5530 Immunoglobulin G (Fc fragment specific) immunological test system.
- 866.5540 Immunoglobulin G (Fd fragment specific) immunological test system.
- 866.5550 Immunoglobulin (light chain specific) immunological test system.
- 866.5560 Lactic dehydrogenase immunological test system.

#### Subpart E—Immunology Laboratory Equipment and Reagents

- 866.4070 RNA Preanalytical Systems.
- 866.4100 Complement reagent.
- 866.4500 Immunoelectrophoresis equipment.
- 866.4520 Immunofluorometer equipment.
- 866.4540 Immunonephelometer equipment.
- 866.4600 Ouchterlony agar plate.
- 866.4700 Automated fluorescence *in situ* hybridization (FISH) enumeration systems.
- 866.4750 Automated indirect immunofluorescence microscope and software-assisted system.
- 866.4800 Radial immunodiffusion plate.
- 866.4830 Rocket immunoelectrophoresis equipment.
- 866.4900 Support gel.

#### Subpart F—Immunological Test Systems

- 866.5040 Albumin immunological test system.
- 866.5060 Prealbumin immunological test system.
- 866.5065 Human allotypic marker immunological test system.
- 866.5080 *Alpha-1-antichymotrypsin* immunological test system.
- 866.5090 Antimitochondrial antibody immunological test system.
- 866.5100 Antinuclear antibody immunological test system.
- 866.5110 Antiparietal antibody immunological test system.
- 866.5120 Antismooth muscle antibody immunological test system.
- 866.5130 *Alpha-1-antitrypsin* immunological test system.
- 866.5150 Bence-Jones proteins immunological test system.

## Food and Drug Administration, HHS

## § 866.1

866.5570 Lactoferrin immunological test system.

866.5580 *Alpha*-1-lipoprotein immunological test system.

866.5590 Lipoprotein X immunological test system.

866.5600 Low-density lipoprotein immunological test system.

866.5620 *Alpha*-2-macroglobulin immunological test system.

866.5630 *Beta*-2-microglobulin immunological test system.

866.5640 Infectious mononucleosis immunological test system.

866.5660 Multiple autoantibodies immunological test system.

866.5665 Aquaporin-4 autoantibody immunological test system.

866.5670 Zinc transporter 8 autoantibody immunological test system.

866.5680 Myoglobin immunological test system.

866.5700 Whole human plasma or serum immunological test system.

866.5715 Plasminogen immunological test system.

866.5735 Prothrombin immunological test system.

866.5750 Radioallergosorbent (RAST) immunological test system.

866.5760 Tryptase test system.

866.5765 Retinol-binding protein immunological test system.

866.5775 Rheumatoid factor immunological test system.

866.5785 Anti-*Saccharomyces cerevisiae* (*S. cerevisiae*) antibody (ASCA) test systems.

866.5800 Seminal fluid (sperm) immunological test system.

866.5820 Systemic lupus erythematosus immunological test system.

866.5830 Brain trauma assessment test.

866.5860 Total spinal fluid immunological test system.

866.5870 Thyroid autoantibody immunological test system.

866.5880 Transferrin immunological test system.

866.5890 Inter-*alpha* trypsin inhibitor immunological test system.

866.5900 Cystic fibrosis transmembrane conductance regulator (CFTR) gene mutation detection system.

866.5910 Quality control material for cystic fibrosis nucleic acid assays.

866.5930 Newborn screening test for severe combined immunodeficiency disorder (SCID).

866.5940 Autosomal recessive carrier screening gene mutation detection system.

866.5950 Genetic health risk assessment system.

### Subpart G—Tumor Associated Antigen Immunological Test Systems

866.6010 Tumor associated antigen immunological test system.

866.6020 Immunomagnetic circulating cancer cell selection and enumeration system.

866.6030 AFP-L3% immunological test system.

866.6040 Gene expression profiling test system for breast cancer prognosis.

866.6050 Ovarian adnexal mass assessment score test system.

866.6060 BCR-ABL quantitation test.

866.6080 Next generation sequencing based tumor profiling test.

AUTHORITY: 21 U.S.C. 351, 360, 360c, 360e, 360j, 360l, 371.

SOURCE: 47 FR 50823, Nov. 9, 1982, unless otherwise noted.

EDITORIAL NOTE: Nomenclature changes to part 866 appear at 73 FR 35341, June 23, 2008.

### Subpart A—General Provisions

#### § 866.1 Scope.

(a) This part sets forth the classification of immunology and microbiology devices intended for human use that are in commercial distribution.

(b) The identification of a device in a regulation in this part is not a precise description of every device that is, or will be, subject to the regulation. A manufacturer who submits a pre-market notification submission for a device under part 807 may not show merely that the device is accurately described by the section title and identification provisions of a regulation in this part, but shall state why the device is substantially equivalent to other devices, as required by § 807.87.

(c) To avoid duplicative listings, an immunology and microbiology device that has two or more types of uses (e.g., used both as a diagnostic device and as a microbiology device) is listed only in one subpart.

(d) References in this part to regulatory sections of the Code of Federal Regulations are to chapter I of title 21, unless otherwise noted.

(e) Guidance documents referenced in this part are available on the Internet at <http://www.fda.gov/MedicalDevices/>

### § 866.3

*Device Regulation and Guidance/  
Guidance Documents/default.htm.*

[52 FR 17733, May 11, 1987, as amended at 68 FR 5827, Feb. 5, 2003; 79 FR 50552, Aug. 25, 2014]

#### **§ 866.3 Effective dates of requirement for premarket approval.**

A device included in this part that is classified into class III (Premarket approval) shall not be commercially distributed after the date shown in the regulation classifying the device unless the manufacturer has an approval under section 515 of the act (unless an exemption has been granted under section 520(g)(2) of the act). An approval under section 515 of the act consists of FDA's issuance of an order approving an application for premarket approval (PMA) for the device or declaring completed a product development protocol (PDP) for the device.

(a) Before FDA requires that a device commercially distributed before the enactment date of the amendments, or a device that has been found substantially equivalent to such a device, has an approval under section 515 of the act FDA must promulgate a regulation under section 515(b) of the act requiring such approval, except as provided in paragraphs (b) and (c) of this section. Such a regulation under section 515(b) of the act shall not be effective during the grace period ending on the 90th day after its promulgation or on the last day of the 30th full calendar month after the regulation that classifies the device into class III is effective, whichever is later. See section 501(f)(2)(B) of the act. Accordingly, unless an effective date of the requirement for premarket approval is shown in the regulation for a device classified into class III in this part, the device may be commercially distributed without FDA's issuance of an order approving a PMA or declaring completed a PDP for the device. If FDA promulgates a regulation under section 515(b) of the act requiring premarket approval for a device, section 501(f)(1)(A) of the act applies to the device.

(b) Any new, not substantially equivalent, device introduced into commercial distribution on or after May 28, 1976, including a device formerly marketed that has been substantially al-

### 21 CFR Ch. I (4-1-20 Edition)

tered, is classified by statute (section 513(f) of the act) into class III without any grace period and FDA must have issued an order approving a PMA or declaring completed a PDP for the device before the device is commercially distributed unless it is reclassified. If FDA knows that a device being commercially distributed may be a "new" device as defined in this section because of any new intended use or other reasons, FDA may codify the statutory classification of the device into class III for such new use. Accordingly, the regulation for such a class III device states that as of the enactment date of the amendments, May 28, 1976, the device must have an approval under section 515 of the act before commercial distribution.

(c) A device identified in a regulation in this part that is classified into class III and that is subject to the transitional provisions of section 520(l) of the act is automatically classified by statute into class III and must have an approval under section 515 of the act before being commercially distributed. Accordingly, the regulation for such a class III transitional device states that as of the enactment date of the amendments, May 28, 1976, the device must have an approval under section 515 of the act before commercial distribution.

[52 FR 17733, May 11, 1987; 52 FR 22577, June 12, 1987]

#### **§ 866.9 Limitations of exemptions from section 510(k) of the Federal Food, Drug, and Cosmetic Act (the act).**

The exemption from the requirement of premarket notification (section 510(k) of the act) for a generic type of class I or II device is only to the extent that the device has existing or reasonably foreseeable characteristics of commercially distributed devices within that generic type or, in the case of in vitro diagnostic devices, only to the extent that misdiagnosis as a result of using the device would not be associated with high morbidity or mortality. Accordingly, manufacturers of any commercially distributed class I or II device for which FDA has granted an exemption from the requirement of premarket notification must still submit a premarket notification to FDA



before introducing or delivering for introduction into interstate commerce for commercial distribution the device when:

(a) The device is intended for a use different from the intended use of a legally marketed device in that generic type of device; e.g., the device is intended for a different medical purpose, or the device is intended for lay use where the former intended use was by health care professionals only;

(b) The modified device operates using a different fundamental scientific technology than a legally marketed device in that generic type of device; e.g., a surgical instrument cuts tissue with a laser beam rather than with a sharpened metal blade, or an in vitro diagnostic device detects or identifies infectious agents by using deoxyribonucleic acid (DNA) probe or nucleic acid hybridization technology rather than culture or immunoassay technology; or

(c) The device is an in vitro device that is intended:

(1) For use in the diagnosis, monitoring, or screening of neoplastic diseases with the exception of immunohistochemical devices;

(2) For use in screening or diagnosis of familial or acquired genetic disorders, including inborn errors of metabolism;

(3) For measuring an analyte that serves as a surrogate marker for screening, diagnosis, or monitoring life-threatening diseases such as acquired immune deficiency syndrome (AIDS), chronic or active hepatitis, tuberculosis, or myocardial infarction or to monitor therapy;

(4) For assessing the risk of cardiovascular diseases;

(5) For use in diabetes management;

(6) For identifying or inferring the identity of a microorganism directly from clinical material;

(7) For detection of antibodies to microorganisms other than immunoglobulin G (IgG) or IgG assays when the results are not qualitative, or are used to determine immunity, or the assay is intended for use in matrices other than serum or plasma;

(8) For noninvasive testing as defined in § 812.3(k) of this chapter; and

(9) For near patient testing (point of care).

[65 FR 2311, Jan. 14, 2000]

### Subpart B—Diagnostic Devices

#### § 866.1620 Antimicrobial susceptibility test disc.

(a) *Identification.* An antimicrobial susceptibility test disc is a device that consists of antimicrobial-impregnated paper discs used to measure by a disc-agar diffusion technique or a disc-broth elution technique the in vitro susceptibility of most clinically important bacterial pathogens to antimicrobial agents. In the disc-agar diffusion technique, bacterial susceptibility is ascertained by directly measuring the magnitude of a zone of bacterial inhibition around the disc on an agar surface. The disc-broth elution technique is associated with an automated rapid susceptibility test system and employs a fluid medium in which susceptibility is ascertained by photometrically measuring changes in bacterial growth resulting when antimicrobial material is eluted from the disc into the fluid medium. Test results are used to determine the antimicrobial agent of choice in the treatment of bacterial diseases.

(b) *Classification.* Class II (performance standards).

#### § 866.1640 Antimicrobial susceptibility test powder.

(a) *Identification.* An antimicrobial susceptibility test powder is a device that consists of an antimicrobial drug powder packaged in vials in specified amounts and intended for use in clinical laboratories for determining in vitro susceptibility of bacterial pathogens to these therapeutic agents. Test results are used to determine the antimicrobial agent of choice in the treatment of bacterial diseases.

(b) *Classification.* Class II (performance standards).

#### § 866.1645 Fully automated short-term incubation cycle antimicrobial susceptibility system.

(a) *Identification.* A fully automated short-term incubation cycle antimicrobial susceptibility system is a device that incorporates concentrations of antimicrobial agents into a system

for the purpose of determining in vitro susceptibility of bacterial pathogens isolated from clinical specimens. Test results obtained from short-term (less than 16 hours) incubation are used to determine the antimicrobial agent of choice to treat bacterial diseases.

(b) *Classification*. Class II (special controls). The special control for this device is FDA's guidance document entitled "Class II Special Controls Guidance Document: Antimicrobial Susceptibility Test (AST) Systems; Guidance for Industry and FDA."

[68 FR 5827, Feb. 5, 2003]

**§ 866.1700 Culture medium for antimicrobial susceptibility tests.**

(a) *Identification*. A culture medium for antimicrobial susceptibility tests is a device intended for medical purposes that consists of any medium capable of supporting the growth of many of the bacterial pathogens that are subject to antimicrobial susceptibility tests. The medium should be free of components known to be antagonistic to the common agents for which susceptibility tests are performed in the treatment of disease.

(b) *Classification*. Class II (performance standards).

**Subpart C—Microbiology Devices**

**§ 866.2050 Staphylococcal typing bacteriophage.**

(a) *Identification*. A staphylococcal typing bacteriophage is a device consisting of a bacterial virus intended for medical purposes to identify pathogenic staphylococcal bacteria through use of the bacteria's susceptibility to destruction by the virus. Test results are used principally for the collection of epidemiological information.

(b) *Classification*. Class I (general controls). The device is exempt from the premarket notification procedures in subpart E of part 807 of this chapter subject to the limitations in § 866.9.

[47 FR 50823, Nov. 9, 1982, as amended at 54 FR 25045, June 12, 1989; 66 FR 38790, July 25, 2001]

**§ 866.2120 Anaerobic chamber.**

(a) *Identification*. An anaerobic chamber is a device intended for medical

purposes to maintain an anaerobic (oxygen free) environment. It is used to isolate and cultivate anaerobic microorganisms.

(b) *Classification*. Class I (general controls). The device is exempt from the premarket notification procedures in subpart E of part 807 of this chapter subject to the limitations in § 866.9. The device is also exempt from the good manufacturing practice requirements of the quality system regulation in part 820 of this chapter, with the exception of § 820.180, with respect to general requirements concerning records, and § 820.198, with respect to complaint files.

[47 FR 50823, Nov. 9, 1982, as amended at 66 FR 38790, July 25, 2001]

**§ 866.2160 Coagulase plasma.**

(a) *Identification*. Coagulase plasma is a device that consists of freeze-dried animal or human plasma that is intended for medical purposes to perform coagulase tests primarily on staphylococcal bacteria. When reconstituted, the fluid plasma is clotted by the action of the enzyme coagulase which is produced by pathogenic staphylococci. Test results are used primarily as an aid in the diagnosis of disease caused by pathogenic bacteria belonging to the genus *Staphylococcus* and provide epidemiological information on disease caused by these microorganisms.

(b) *Classification*. Class I (general controls). The device is exempt from the premarket notification procedures in subpart E of part 807 of this chapter subject to the limitations in § 866.9.

[47 FR 50823, Nov. 9, 1982, as amended at 61 FR 1119, Jan. 16, 1996; 66 FR 38790, July 25, 2001]

**§ 866.2170 Automated colony counter.**

(a) *Identification*. An automated colony counter is a mechanical device intended for medical purposes to determine the number of bacterial colonies present on a bacteriological culture medium contained in a petri plate. The number of colonies counted is used in the diagnosis of disease as a measure of the degree of bacterial infection.

(b) *Classification*. Class I (general controls). The device is exempt from the premarket notification procedures in

subpart E of part 807 of this chapter subject to the limitations in § 866.9.

[47 FR 50823, Nov. 9, 1982, as amended at 54 FR 25045, June 12, 1989; 66 FR 38790, July 25, 2001]

**§ 866.2180 Manual colony counter.**

(a) *Identification.* A manual colony counter is a device intended for medical purposes that consists of a printed grid system superimposed on an illuminated screen. Petri plates containing bacterial colonies to be counted are placed on the screen for better viewing and ease of counting. The number of colonies counted is used in the diagnosis of disease as a measure of the degree of bacterial infection.

(b) *Classification.* Class I (general controls). The device is exempt from the premarket notification procedures in subpart E of part 807 of this chapter subject to the limitations in § 866.9. The device is also exempt from the good manufacturing practice requirements of the quality system regulation in part 820 of this chapter, with the exception of § 820.180, with respect to general requirements concerning records, and § 820.198, with respect to complaint files.

[47 FR 50823, Nov. 9, 1982, as amended at 66 FR 38790, July 25, 2001]

**§ 866.2190 Automated image assessment system for microbial colonies on solid culture media.**

(a) *Identification.* An automated image assessment system for microbial colonies on solid culture media is a system that is intended to assess the presence or absence of microbial colonies on solid microbiological culture medium, and to interpret their number, and phenotypic and morphologic characteristics through analysis of two dimensional digital images as an aid in diagnosis of infectious disease.

(b) *Classification.* Class II (special controls). The special controls for this device are:

(1) Premarket notification submissions must include a detailed description of the device, including the technology employed, components and software modules, as well as a detailed explanation of the result algorithms and any expert rules that are used to assess colony characteristics and enumerate

colonies from image capture through end result.

(2) Premarket notification submissions must include detailed documentation of the analytical studies performed to characterize device performance to support the intended use, as appropriate.

(3) Premarket notification submissions must include detailed documentation from clinical studies performed on a population that is consistent with the intended use population.

(i) The clinical studies must establish the device performance based on comparison to results obtained by an acceptable reference method, as appropriate.

(ii) The clinical study documentation must include the study protocol with a predefined statistical analysis plan and the final report documenting support for the Indications for Use and the results of the statistical analysis, as appropriate.

(4) Premarket notification submissions must include detailed documentation for device software, including but not limited to software applications and hardware based components that incorporate software, and any decision-making thresholds used to generate results for the device. If a part of a Total Laboratory Automation System, the premarket notification submission must include detailed documentation addressing the instrument and software system integration.

(5) Premarket notification submissions must include detailed documentation of appropriate instructions for use regarding the intended user's device quality control procedures for the instrument system and components, as appropriate.

(6) The 21 CFR 809.10 compliant device labeling must include:

(i) Detailed user instructions to mitigate the risk of failure to operate the instrument correctly.

(ii) A detailed explanation of the interpretation of results and limitations regarding the need for review of culture plates by a qualified microbiologist, as appropriate.

(iii) A summary of performance data obtained from the analytical studies

## § 866.2300

used to support device performance, as appropriate.

(iv) A summary of performance data obtained from clinical studies performed on a population that is consistent with the intended use population, as appropriate.

(7) Under 21 CFR 820.30 compliant design control, device manufacturers must, as appropriate:

(i) Conduct human factors/usability validation testing with the final version of the labeling and related materials to adequately mitigate the risk of failure to operate the instrument correctly.

(ii) Document a device training program that will be offered to the end user to adequately mitigate the risk of failure to operate the instrument correctly.

[82 FR 47969, Oct. 16, 2017]

## § 866.2300 Multipurpose culture medium.

(a) *Identification.* A multipurpose culture medium is a device that consists primarily of liquid or solid biological materials intended for medical purposes for the cultivation and identification of several types of pathogenic microorganisms without the need of additional nutritional supplements. Test results aid in the diagnosis of disease and also provide epidemiological information on diseases caused by these microorganisms.

(b) *Classification.* Class I (general controls). The device is exempt from the premarket notification procedures in subpart E of part 807 of this chapter subject to the limitations in § 866.9.

[47 FR 50823, Nov. 9, 1982, as amended at 54 FR 25046, June 12, 1989; 66 FR 38790, July 25, 2001]

## § 866.2320 Differential culture medium.

(a) *Identification.* A differential culture medium is a device that consists primarily of liquid biological materials intended for medical purposes to cultivate and identify different types of pathogenic microorganisms. The identification of these microorganisms is accomplished by the addition of a specific biochemical component(s) to the medium. Microorganisms are identified by a visible change (e.g., a color

## 21 CFR Ch. I (4–1–20 Edition)

change) in a specific biochemical component(s) which indicates that specific metabolic reactions have occurred. Test results aid in the diagnosis of disease and also provide epidemiological information on diseases caused by these microorganisms.

(b) *Classification.* Class I (general controls). The device is exempt from the premarket notification procedures in subpart E of part 807 of this chapter subject to the limitations in § 866.9.

[47 FR 50823, Nov. 9, 1982, as amended at 54 FR 25046, June 12, 1989; 66 FR 38790, July 25, 2001]

## § 866.2330 Enriched culture medium.

(a) *Identification.* An enriched culture medium is a device that consists primarily of liquid or solid biological materials intended for medical purposes to cultivate and identify fastidious microorganisms (those having complex nutritional requirements). The device consists of a relatively simple basal medium enriched by the addition of such nutritional components as blood, blood serum, vitamins, and extracts of plant or animal tissues. The device is used in the diagnosis of disease caused by pathogenic microorganisms and also provides epidemiological information on these diseases.

(b) *Classification.* Class I (general controls). The device is exempt from the premarket notification procedures in subpart E of part 807 of this chapter subject to the limitations in § 866.9.

[47 FR 50823, Nov. 9, 1982, as amended at 54 FR 25046, June 12, 1989; 66 FR 38791, July 25, 2001]

## § 866.2350 Microbiological assay culture medium.

(a) *Identification.* A microbiological assay culture medium is a device that consists primarily of liquid or solid biological materials intended for medical purposes to cultivate selected test microorganisms in order to measure by microbiological procedures the concentration in a patient's serum of certain substances, such as amino acids, antimicrobial agents, and vitamins. The concentration of these substances is measured by their ability to promote or inhibit the growth of the test organism in the inoculated medium. Test results aid in the diagnosis of disease

resulting from either deficient or excessive amounts of these substances in a patient's serum. Tests results may also be used to monitor the effects of the administration of certain antimicrobial drugs.

(b) *Classification*. Class I (general controls). The device is exempt from the premarket notification procedures in subpart E of part 807 of this chapter subject to the limitations in § 866.9.

[47 FR 50823, Nov. 9, 1982, as amended at 54 FR 25046, June 12, 1989; 66 FR 38791, July 25, 2001]

**§ 866.2360 Selective culture medium.**

(a) *Identification*. A selective culture medium is a device that consists primarily of liquid or solid biological materials intended for medical purposes to cultivate and identify certain pathogenic microorganisms. The device contains one or more components that suppress the growth of certain microorganisms while either promoting or not affecting the growth of other microorganisms. The device aids in the diagnosis of disease caused by pathogenic microorganisms and also provides epidemiological information on these diseases.

(b) *Classification*. Class I (general controls). The device is exempt from the premarket notification procedures in subpart E of part 807 of this chapter subject to the limitations in § 866.9.

[47 FR 50823, Nov. 9, 1982, as amended at 54 FR 25046, June 12, 1989; 66 FR 38791, July 25, 2001]

**§ 866.2390 Transport culture medium.**

(a) *Identification*. A transport culture medium is a device that consists of a semisolid, usually non-nutrient, medium that maintains the viability of suspected pathogens contained in patient specimens while in transit from the specimen collection area to the laboratory. The device aids in the diagnosis of disease caused by pathogenic microorganisms and also provides epidemiological information on these diseases.

(b) *Classification*. Class I (general controls).

**§ 866.2410 Culture medium for pathogenic *Neisseria* spp.**

(a) *Identification*. A culture medium for pathogenic *Neisseria* spp. is a device that consists primarily of liquid or solid biological materials used to cultivate and identify pathogenic *Neisseria* spp. The identification aids in the diagnosis of disease caused by bacteria belonging to the genus *Neisseria*, such as epidemic cerebrospinal meningitis, other meningococcal disease, and gonorrhea, and also provides epidemiological information on these microorganisms.

(b) *Classification*. Class II (performance standards).

**§ 866.2420 Oxidase screening test for gonorrhea.**

(a) *Identification*. An oxidase screening test for gonorrhea is an in vitro device that consists of the articles intended to identify by chemical reaction, cytochrome oxidase, an oxidizing enzyme that is associated with certain bacteria including *Neisseria gonorrhoeae*. A sample of a male's urethral discharge is obtained on a swab which is placed into a wetting agent containing an ingredient that will react with cytochrome oxidase. When cytochrome oxidase is present, the swab turns a dark purple color within 3 minutes. Because it is unlikely that cytochrome oxidase-positive organisms other than *Neisseria gonorrhoeae* are present in the urethral discharge of males, the identification of cytochrome oxidase with this device indicates presumptive infection of the patient with the causative agent of gonorrhea.

(b) *Classification*. Class III (premarket approval) (transitional device).

(c) *Date PMA or notice of completion of a PDP is required*. As of May 28, 1976, an approval under section 515 of the act is required before this device may be commercially distributed. See § 866.3.

[47 FR 50823, Nov. 9, 1982, as amended at 52 FR 17734, May 11, 1987]

**§ 866.2440 Automated medium dispensing and stacking device.**

(a) *Identification*. An automated medium dispensing and stacking device is a device intended for medical purposes to dispense a microbiological culture

## § 866.2450

medium into petri dishes and then mechanically stack the petri dishes.

(b) *Classification.* Class I (general controls). The device is exempt from the premarket notification procedures in subpart E of part 807 of this chapter subject to the limitations in § 866.9. The device is also exempt from the good manufacturing practice requirements of the quality system regulation in part 820 of this chapter, with the exception of § 820.180, with respect to general requirements concerning records, and § 820.198, with respect to complaint files.

[47 FR 50823, Nov. 9, 1982, as amended at 66 FR 38791, July 25, 2001]

## § 866.2450 Supplement for culture media.

(a) *Identification.* A supplement for culture media is a device, such as a vitamin or sugar mixture, that is added to a solid or liquid basal culture medium to produce a desired formulation and that is intended for medical purposes to enhance the growth of fastidious microorganisms (those having complex nutritional requirements). This device aids in the diagnosis of diseases caused by pathogenic microorganisms.

(b) *Classification.* Class I (general controls). The device is exempt from the premarket notification procedures in subpart E of part 807 of this chapter subject to the limitations in § 866.9.

[47 FR 50823, Nov. 9, 1982, as amended at 54 FR 25046, June 12, 1989; 66 FR 38791, July 25, 2001]

## § 866.2480 Quality control kit for culture media.

(a) *Identification.* A quality control kit for culture media is a device that consists of paper discs (or other suitable materials), each impregnated with a specified, freeze-dried, viable microorganism, intended for medical purposes to determine if a given culture medium is able to support the growth of that microorganism. The device aids in the diagnosis of disease caused by pathogenic microorganisms and also provides epidemiological information on these diseases.

(b) *Classification.* Class I (general controls). The device is exempt from the premarket notification procedures in

## 21 CFR Ch. I (4–1–20 Edition)

subpart E of part 807 of this chapter subject to the limitations in § 866.9.

[47 FR 50823, Nov. 9, 1982, as amended at 54 FR 25046, June 12, 1989; 66 FR 38791, July 25, 2001]

## § 866.2500 Microtiter diluting and dispensing device.

(a) *Identification.* A microtiter diluting and dispensing device is a mechanical device intended for medical purposes to dispense or serially dilute very small quantities of biological or chemical reagents for use in various diagnostic procedures.

(b) *Classification.* Class I (general controls). The device is exempt from the premarket notification procedures in subpart E of part 807 of this chapter subject to the limitations in § 866.9.

[47 FR 50823, Nov. 9, 1982, as amended at 54 FR 25046, June 12, 1989; 66 FR 38791, July 25, 2001]

## § 866.2540 Microbiological incubator.

(a) *Identification.* A microbiological incubator is a device with various chambers or water-filled compartments in which controlled environmental conditions, particularly temperature, are maintained. It is intended for medical purposes to cultivate microorganisms and aid in the diagnosis of disease.

(b) *Classification.* Class I (general controls). The device is exempt from the premarket notification procedures in subpart E of part 807 of this chapter subject to the limitations in § 866.9. The device is also exempt from the good manufacturing practice requirements of the quality system regulation in part 820 of this chapter, with the exception of § 820.180, with respect to general requirements concerning records, and § 820.198, with respect to complaint files.

[47 FR 50823, Nov. 9, 1982, as amended at 66 FR 38791, July 25, 2001]

## § 866.2560 Microbial growth monitor.

(a) *Identification.* A microbial growth monitor is a device intended for medical purposes that measures the concentration of bacteria suspended in a liquid medium by measuring changes in light scattering properties, optical density, electrical impedance, or by making direct bacterial counts. The

device aids in the diagnosis of disease caused by pathogenic microorganisms.

(b) *Classification*. Class I. With the exception of automated blood culturing system devices that are used in testing for bacteria, fungi, and other microorganisms in blood and other normally sterile body fluids, this device is exempt from the premarket notification procedures in subpart E of part 807 of this chapter.

[47 FR 50823, Nov. 9, 1982, as amended at 60 FR 38482, July 27, 1995]

**§ 866.2580 Gas-generating device.**

(a) *Identification*. A gas-generating device is a device intended for medical purposes that produces predetermined amounts of selected gases to be used in a closed chamber in order to establish suitable atmospheric conditions for cultivation of microorganisms with special atmospheric requirements. The device aids in the diagnosis of disease.

(b) *Classification*. Class I (general controls). The device is exempt from the premarket notification procedures in subpart E of part 807 of this chapter subject to the limitations in § 866.9.

[47 FR 50823, Nov. 9, 1982, as amended at 54 FR 25046, June 12, 1989; 66 FR 38791, July 25, 2001]

**§ 866.2600 Wood's fluorescent lamp.**

(a) *Identification*. A Wood's fluorescent lamp is a device intended for medical purposes to detect fluorescent materials (e.g., fluorescein pigment produced by certain microorganisms) as an aid in the identification of these microorganisms. The device aids in the diagnosis of disease.

(b) *Classification*. Class I (general controls). The device is exempt from the premarket notification procedures in subpart E of part 807 of this chapter subject to the limitations in § 866.9. The device is also exempt from the good manufacturing practice requirements of the quality system regulation in part 820 of this chapter, with the exception of § 820.180, with respect to general requirements concerning records, and § 820.198, with respect to complaint files.

[47 FR 50823, Nov. 9, 1982, as amended at 66 FR 38791, July 25, 2001]

**§ 866.2660 Microorganism differentiation and identification device.**

(a) *Identification*. A microorganism differentiation and identification device is a device intended for medical purposes that consists of one or more components, such as differential culture media, biochemical reagents, and paper discs or paper strips impregnated with test reagents, that are usually contained in individual compartments and used to differentiate and identify selected microorganisms. The device aids in the diagnosis of disease.

(b) *Classification*. Class I (general controls). The device is exempt from the premarket notification procedures in subpart E of part 807 of this chapter subject to § 866.9.

[47 FR 50823, Nov. 9, 1982, as amended at 65 FR 2311, Jan. 14, 2000]

**§ 866.2680 *Streptococcus spp.* nucleic acid-based assay.**

(a) *Identification*. A *Streptococcus spp.* nucleic acid-based assay is a qualitative in vitro diagnostic device intended to simultaneously detect and identify various *Streptococcus spp.* nucleic acids extracted directly from clinical specimens. The device detects specific nucleic acid sequences for organism identification. The identification aids in the diagnosis of diseases caused by bacteria belonging to the genus *Streptococcus* and provides epidemiological information on these diseases. Pathogenic streptococci are associated with infections, such as sore throat, impetigo (an infection characterized by small pustules on the skin), urinary tract infections, rheumatic fever, and kidney disease.

(b) *Classification*. Class II (special controls). The special controls for this device are:

(1) Premarket notification submissions must include detailed device description documentation, including the device components, ancillary reagents required but not provided, and a detailed explanation of the methodology including primer/probe sequence, design, and rationale for sequence selection.

(2) Premarket notification submissions must include detailed documentation from the following analytical and clinical performance studies:

## § 866.2850

Analytical sensitivity (Limit of Detection), reactivity, inclusivity, precision, reproducibility, interference, cross reactivity, carry-over, and cross contamination.

(3) Premarket notification submissions must include detailed documentation from a clinical study. The study, performed on a study population consistent with the intended use population, must compare the device performance to results obtained from well-accepted reference methods.

(4) Premarket notification submissions must include detailed documentation for device software, including, but not limited to, software applications and hardware-based devices that incorporate software.

(5) Premarket notification submissions must include database implementation methodology, construction parameters, and quality assurance protocols, as appropriate.

(6) The device labeling must include limitations regarding the need for culture confirmation of negative specimens, as appropriate.

(7) A detailed explanation of the interpretation of results and acceptance criteria must be included in the device's 21 CFR 809.10(b)(9) compliant labeling.

(8) Premarket notification submissions must include details on an end user device training program that will be offered while marketing the device, as appropriate.

[82 FR 50074, Oct. 30, 2017]

### § 866.2850 Automated zone reader.

(a) *Identification.* An automated zone reader is a mechanical device intended for medical purposes to measure zone diameters of microbial growth inhibition (or exhibition), such as those observed on the surface of certain culture media used in disc-agar diffusion antimicrobial susceptibility tests. The device aids in decisionmaking respecting the treatment of disease.

(b) *Classification.* Class I (general controls).

### § 866.2900 Microbiological specimen collection and transport device.

(a) *Identification.* A microbiological specimen collection and transport device is a specimen collecting chamber

## 21 CFR Ch. I (4–1–20 Edition)

intended for medical purposes to preserve the viability or integrity of microorganisms in specimens during storage of specimens after their collection and during their transport from the collecting area to the laboratory. The device may be labeled or otherwise represented as sterile. The device aids in the diagnosis of disease caused by pathogenic microorganisms.

(b) *Classification.* Class I (general controls). The device is exempt from the premarket notification procedures in subpart E of part 807 of this chapter subject to the limitations in § 866.9.

[47 FR 50823, Nov. 9, 1982, as amended at 84 FR 71800, Dec. 30, 2019]

## Subpart D—Serological Reagents

### § 866.3010 *Acinetobacter calcoaceticus* serological reagents.

(a) *Identification.* *Acinetobacter calcoaceticus* serological reagents are devices that consist of *Acinetobacter calcoaceticus* antigens and antisera used to identify this bacterium from cultured isolates derived from clinical specimens. The identification aids in the diagnosis of disease caused by the bacterium *Acinetobacter calcoaceticus* and provides epidemiological information on disease caused by this microorganism. This organism becomes pathogenic in patients with burns or with immunologic deficiency, and infection can result in sepsis (blood poisoning).

(b) *Classification.* Class I (general controls). The device is exempt from the premarket notification procedures in subpart E of part 807 of this chapter subject to the limitations in § 866.9.

[47 FR 50823, Nov. 9, 1982, as amended at 54 FR 25046, June 12, 1989; 66 FR 38791, July 25, 2001]

### § 866.3020 Adenovirus serological reagents.

(a) *Identification.* Adenovirus serological reagents are devices that consist of antigens and antisera used in serological tests to identify antibodies to adenovirus in serum. Additionally, some of these reagents consist of adenovirus antisera conjugated with a fluorescent dye and are used to identify adenoviruses directly from clinical



specimens. The identification aids in the diagnosis of disease caused by adenoviruses and provides epidemiological information on these diseases. Adenovirus infections may cause pharyngitis (inflammation of the throat), acute respiratory diseases, and certain external diseases of the eye (e.g., conjunctivitis).

(b) *Classification.* Class I (general controls). The device is exempt from the premarket notification procedures in subpart E of part 807 of this chapter subject to the limitations in § 866.9.

[47 FR 50823, Nov. 9, 1982, as amended at 54 FR 25046, June 12, 1989; 66 FR 38791, July 25, 2001]

**§ 866.3035 *Arizona* spp. serological reagents.**

(a) *Identification.* *Arizona* spp. serological reagents are devices that consist of antisera and antigens used to identify *Arizona* spp. in cultured isolates derived from clinical specimens. The identification aids in the diagnosis of disease caused by bacteria belonging to the genus *Arizona* and provides epidemiological information on diseases caused by these microorganisms. *Arizona* spp. can cause gastroenteritis (food poisoning) and sepsis (blood poisoning).

(b) *Classification.* Class I (general controls). The device is exempt from the premarket notification procedures in subpart E of part 807 of this chapter subject to the limitations in § 866.9.

[47 FR 50823, Nov. 9, 1982, as amended at 54 FR 25046, June 12, 1989; 66 FR 38791, July 25, 2001]

**§ 866.3040 *Aspergillus* spp. serological reagents.**

(a) *Identification.* *Aspergillus* spp. serological reagents are devices that consist of antigens and antisera used in various serological tests to identify antibodies to *Aspergillus* spp. in serum. The identification aids in the diagnosis of aspergillosis caused by fungi belonging to the genus *Aspergillus*. Aspergillosis is a disease marked by inflammatory granulomatous (tumor-like) lesions in the skin, ear, eyeball cavity, nasal sinuses, lungs, and occasionally the bones.

(b) *Classification.* Class I (general controls). The device is exempt from the

premarket notification procedures in subpart E of part 807 of this chapter subject to § 866.9.

[47 FR 50823, Nov. 9, 1982, as amended at 65 FR 2311, Jan. 14, 2000]

**§ 866.3045 *In vitro* diagnostic device for *Bacillus* spp. detection.**

(a) *Identification.* An *in vitro* diagnostic device for *Bacillus* species (spp.) detection is a prescription device used to detect and differentiate among *Bacillus* spp. and presumptively identify *B. anthracis* and other *Bacillus* spp. from cultured isolates or clinical specimens as an aid in the diagnosis of anthrax and other diseases caused by *Bacillus* spp. This device may consist of *Bacillus* spp. antisera conjugated with a fluorescent dye (immunofluorescent reagents) used to presumptively identify bacillus-like organisms in clinical specimens; bacteriophage used for differentiating *B. anthracis* from other *Bacillus* spp. based on susceptibility to lysis by the phage; or antigens used to identify antibodies to *B. anthracis* (anti-toxin and anti-capsular) in serum. *Bacillus* infections include anthrax (cutaneous, inhalational, or gastrointestinal) caused by *B. anthracis*, and gastrointestinal disease and non-gastrointestinal infections caused by *B. cereus*.

(b) *Classification.* Class II (special controls). The special controls are set forth in FDA's special controls guideline document entitled "In Vitro Diagnostic Devices for *Bacillus* spp. Detection; Class II Special Controls Guideline for Industry and Food and Drug Administration Staff." For availability of the guideline document, see § 866.1(e).

(c) *Restriction on Distribution.* The distribution of these devices is limited to laboratories that follow public health guidelines that address appropriate biosafety conditions, interpretation of test results, and coordination of findings with public health authorities.

(d) *Restriction on Use.* The use of this device is restricted to prescription use and must comply with the following:

(1) The device must be in the possession of:

(i)(A) A person, or his agents or employees, regularly and lawfully engaged in the manufacture, transportation,

storage, or wholesale or retail distribution of such device; or

(B) A practitioner, such as a physician, licensed by law to use or order the use of such device; and

(ii) The device must be sold only to or on the prescription or other order of such practitioner for use in the course of his professional practice.

(2) The label of the device shall bear the statement “Caution: Federal law restricts this device to sale by or on the order of a \_\_\_”, the blank to be filled with the word “physician” or with the descriptive designation of any other practitioner licensed by the law of the State in which he practices to use or order the use of the device.

(3) Any labeling, as defined in section 201(m) of the Federal Food, Drug, and Cosmetic Act, whether or not it is on or within a package from which the device is to be dispensed, distributed by, or on behalf of the manufacturer, packer, or distributor of the device, that furnishes or purports to furnish information for use of the device contains adequate information for such use, including indications, effects, routes, methods, and frequency and duration of administration and any relevant hazards, contraindications, side effects, and precautions, under which practitioners licensed by law to employ the device can use the device safely and for the purposes for which it is intended, including all purposes for which it is advertised or represented. This information will not be required on so-called reminder-piece labeling which calls attention to the name of the device but does not include indications or other use information.

(4) All labeling, except labels and cartons, bearing information for use of the device also bears the date of the issuance or the date of the latest revision of such labeling.

[84 FR 12088, Apr. 1, 2019]

**§ 866.3050 Beta-glucan serological assays.**

(a) *Identification.* Beta-glucan serological assays are devices that consist of antigens or proteases used in serological assays. The device is intended for use for the presumptive diagnosis of fungal infection. The assay is indicated for use in patients with symptoms of,

or medical conditions predisposing the patient to invasive fungal infection. The device can be used as an aid in the diagnosis of deep seated mycoses and fungemias.

(b) *Classification.* Class II (special controls). The special control is FDA’s guidance document entitled “Class II Special Controls Guidance Document: Serological Assays for the Detection of Beta-Glucan.” See § 866.1(e) for the availability of this guidance document.

[69 FR 56936, Sept. 23, 2004]

**§ 866.3060 *Blastomyces dermatitidis* serological reagents.**

(a) *Identification.* *Blastomyces dermatitidis* serological reagents are devices that consist of antigens and antisera used in serological tests to identify antibodies to *Blastomyces dermatitidis* in serum. The identification aids in the diagnosis of blastomycosis caused by the fungus *Blastomyces dermatitidis*. Blastomycosis is a chronic granulomatous (tumor-like) disease, which may be limited to the skin or lung or may be widely disseminated in the body resulting in lesions of the bones, liver, spleen, and kidneys.

(b) *Classification.* Class II (special controls). The device is exempt from the premarket notification procedures in subpart E of part 807 of this chapter subject to § 866.9.

[47 FR 50823, Nov. 9, 1982, as amended at 63 FR 59226, Nov. 3, 1998]

**§ 866.3065 *Bordetella* spp. serological reagents.**

(a) *Identification.* *Bordetella* spp. serological reagents are devices that consist of antigens and antisera, including antisera conjugated with a fluorescent dye, used in serological tests to identify *Bordetella* spp. from cultured isolates or directly from clinical specimens. The identification aids in the diagnosis of diseases caused by bacteria belonging to the genus *Bordetella* and provides epidemiological information on these diseases. *Bordetella* spp. cause whooping cough (*Bordetella pertussis*) and other similarly contagious and acute respiratory infections characterized by pneumonitis (inflammation of the lungs).

(b) *Classification*. Class I (general controls). The device is exempt from the premarket notification procedures in subpart E of part 807 of this chapter subject to the limitations in § 866.9.

[47 FR 50823, Nov. 9, 1982, as amended at 54 FR 25046, June 12, 1989; 66 FR 38791, July 25, 2001]

**§ 866.3085 *Brucella* spp. serological reagents.**

(a) *Identification*. *Brucella* spp. serological reagents are devices that consist of antigens and antisera used for serological identification of *Brucella* spp. from cultured isolates derived from clinical specimens or to identify antibodies to *Brucella* spp. in serum. Additionally, some of these reagents consist of antisera conjugated with a fluorescent dye (immunofluorescent reagents) used to identify *Brucella* spp. directly from clinical specimens or cultured isolates derived from clinical specimens. The identification aids in the diagnosis of brucellosis (e.g., undulant fever, Malta fever) caused by bacteria belonging to the genus *Brucella* and provides epidemiological information on diseases caused by these microorganisms.

(b) *Classification*. Class II (special controls). The device is exempt from the premarket notification procedures in subpart E of part 807 of this chapter subject to § 866.9.

[47 FR 50823, Nov. 9, 1982, as amended at 63 FR 59226, Nov. 3, 1998]

**§ 866.3110 *Campylobacter fetus* serological reagents.**

(a) *Identification*. *Campylobacter fetus* serological reagents are devices that consist of antisera conjugated with a fluorescent dye used to identify *Campylobacter fetus* from clinical specimens or cultured isolates derived from clinical specimens. The identification aids in the diagnosis of diseases caused by this bacterium and provides epidemiological information on these diseases. *Campylobacter fetus* is a frequent cause of abortion in sheep and cattle and is sometimes responsible for endocarditis (inflammation of certain membranes of the heart) and enteritis (inflammation of the intestines) in humans.

(b) *Classification*. Class I (general controls).

**§ 866.3120 *Chlamydia* serological reagents.**

(a) *Identification*. *Chlamydia* serological reagents are devices that consist of antigens and antisera used in serological tests to identify antibodies to *Chlamydia* in serum. Additionally, some of these reagents consist of *Chlamydia* antisera conjugated with a fluorescent dye used to identify *Chlamydia* directly from clinical specimens or cultured isolates derived from clinical specimens. The identification aids in the diagnosis of disease caused by bacteria belonging to the genus *Chlamydia* and provides epidemiological information on these diseases. *Chlamydia* are the causative agents of psittacosis (a form of pneumonia), lymphogranuloma venereum (a venereal disease), and trachoma (a chronic disease of the eye and eyelid).

(b) *Classification*. Class I (general controls).

**§ 866.3125 *Citrobacter* spp. serological reagents.**

(a) *Identification*. *Citrobacter* spp. serological reagents are devices that consist of antigens and antisera used in serological tests to identify *Citrobacter* spp. from cultured isolates derived from clinical specimens. The identification aids in the diagnosis of disease caused by bacteria belonging to the genus *Citrobacter* and provides epidemiological information on diseases caused by these microorganisms. *Citrobacter* spp. have occasionally been associated with urinary tract infections.

(b) *Classification*. Class I (general controls). The device is exempt from the premarket notification procedures in subpart E of part 807 of this chapter subject to the limitations in § 866.9.

[47 FR 50823, Nov. 9, 1982, as amended at 54 FR 25046, June 12, 1989; 66 FR 38791, July 25, 2001]

**§ 866.3130 *Clostridium difficile* toxin gene amplification assay.**

(a) *Identification*. A *Clostridium difficile* toxin gene amplification assay is a device that consists of reagents for

**§ 866.3135**

the amplification and detection of target sequences in *Clostridium difficile* toxin genes in fecal specimens from patients suspected of having *Clostridium difficile* infection (CDI). The detection of clostridial toxin genes, in conjunction with other laboratory tests, aids in the clinical laboratory diagnosis of CDI caused by *Clostridium difficile*.

(b) *Classification*. Class II (special controls). The special controls are set forth in FDA's guideline document entitled: "Class II Special Controls Guideline: Toxin Gene Amplification Assays for the Detection of *Clostridium difficile*; Guideline for Industry and Food and Drug Administration Staff." See § 866.1(e) for information on obtaining this document.

[80 FR 51939, Aug. 27, 2015]

**§ 866.3135 *Coccidioides immitis* serological reagents.**

(a) *Identification*. *Coccidioides immitis* serological reagents are devices that consist of antigens and antisera used in serological tests to identify antibodies to *Coccidioides immitis* in serum. The identification aids in the diagnosis of coccidioidomycosis caused by a fungus belonging to the genus *Coccidioides* and provides epidemiological information on diseases caused by this microorganism. An infection with *Coccidioides immitis* produces symptoms varying in severity from those accompanying the common cold to those of influenza.

(b) *Classification*. Class II (special controls). The device is exempt from the premarket notification procedures in subpart E of part 807 of this chapter subject to § 866.9.

[47 FR 50823, Nov. 9, 1982, as amended at 63 FR 59226, Nov. 3, 1998]

**§ 866.3140 *Corynebacterium* spp. serological reagents.**

(a) *Identification*. *Corynebacterium* spp. serological reagents are devices that consist of antisera conjugated with a fluorescent dye used to identify *Corynebacterium* spp. from clinical specimens. The identification aids in the diagnosis of disease caused by bacteria belonging to the genus *Corynebacterium* and provides epidemiological information on diseases caused by these microorganisms. The principal

**21 CFR Ch. I (4–1–20 Edition)**

human pathogen of this genus, *Corynebacterium diphtheriae*, causes diphtheria. However, many other types of corynebacteria form part of the normal flora of the human respiratory tract, other mucus membranes, and skin, and are either nonpathogenic or have an uncertain role.

(b) *Classification*. Class I (general controls). The device is exempt from the premarket notification procedures in subpart E of part 807 of this chapter subject to § 866.9.

[47 FR 50823, Nov. 9, 1982, as amended at 65 FR 2311, Jan. 14, 2000]

**§ 866.3145 Coxsackievirus serological reagents.**

(a) *Identification*. Coxsackievirus serological reagents are devices that consist of antigens and antisera used in serological tests to identify antibodies to coxsackievirus in serum. Additionally, some of these reagents consist of coxsackievirus antisera conjugated with a fluorescent dye that are used to identify coxsackievirus from clinical specimens or from tissue culture isolates derived from clinical specimens. The identification aids in the diagnosis of coxsackievirus infections and provides epidemiological information on diseases caused by these viruses. Coxsackieviruses produce a variety of infections, including common colds, meningitis (inflammation of brain and spinal cord membranes), herpangina (brief fever accompanied by ulcerated lesions of the throat), and myopericarditis (inflammation of heart tissue).

(b) *Classification*. Class I (general controls). The device is exempt from the premarket notification procedures in subpart E of part 807 of this chapter subject to § 866.9.

[47 FR 50823, Nov. 9, 1982, as amended at 65 FR 2311, Jan. 14, 2000]

**§ 866.3165 *Cryptococcus neoformans* serological reagents.**

(a) *Identification*. *Cryptococcus neoformans* serological reagents are devices that consist of antigens used in serological tests to identify antibodies to *Cryptococcus neoformans* in serum. Additionally, some of these reagents consist of antisera conjugated with a

fluorescent dye (immunofluorescent reagents) and are used to identify *Cryptococcus neoformans* directly from clinical specimens or from cultured isolates derived from clinical specimens. The identification aids in the diagnosis of cryptococcosis and provides epidemiological information on this type of disease. Cryptococcosis infections are found most often as chronic meningitis (inflammation of brain membranes) and, if not treated, are usually fatal.

(b) *Classification*. Class II (special controls). The device is exempt from the premarket notification procedures in subpart E of part 807 of this chapter subject to § 866.9.

[47 FR 50823, Nov. 9, 1982, as amended at 63 FR 59226, Nov. 3, 1998]

**§ 866.3175 Cytomegalovirus serological reagents.**

(a) *Identification*. Cytomegalovirus serological reagents are devices that consist of antigens and antisera used in serological tests to identify antibodies to cytomegalovirus in serum. The identification aids in the diagnosis of diseases caused by cytomegaloviruses (principally cytomegalic inclusion disease) and provides epidemiological information on these diseases. Cytomegalic inclusion disease is a generalized infection of infants and is caused by intrauterine or early post-natal infection with the virus. The disease may cause severe congenital abnormalities, such as microcephaly (abnormal smallness of the head), motor disability, and mental retardation. Cytomegalovirus infection has also been associated with acquired hemolytic anemia, acute and chronic hepatitis, and an infectious mononucleosis-like syndrome.

(b) *Classification*. Class II (performance standards).

**§ 866.3200 *Echinococcus* spp. serological reagents.**

(a) *Identification*. *Echinococcus* spp. serological reagents are devices that consist of *Echinococcus* spp. antigens and antisera used in serological tests to identify antibodies to *Echinococcus* spp. in serum. The identification aids in the diagnosis of echinococcosis, caused by parasitic tapeworms belonging to the

genus *Echinococcus* and provides epidemiological information on this disease. Echinococcosis is characterized by the development of cysts in the liver, lung, kidneys, and other organs formed by the larva of the infecting organisms.

(b) *Classification*. Class I (general controls). The device is exempt from the premarket notification procedures in subpart E of part 807 of this chapter subject to § 866.9.

[47 FR 50823, Nov. 9, 1982, as amended at 65 FR 2311, Jan. 14, 2000]

**§ 866.3205 Echovirus serological reagents.**

(a) *Identification*. Echovirus serological reagents are devices that consist of antigens and antisera used in serological tests to identify antibodies to echovirus in serum. Additionally, some of these reagents consist of echovirus antisera conjugated with a fluorescent dye used to identify echoviruses from clinical specimens or from tissue culture isolates derived from clinical specimens. The identification aids in the diagnosis of echovirus infections and provides epidemiological information on diseases caused by these viruses. Echoviruses cause illnesses such as meningitis (inflammation of the brain and spinal cord membranes), febrile illnesses (accompanied by fever) with or without rash, and the common cold.

(b) *Classification*. Class I (general controls). The device is exempt from the premarket notification procedures in subpart E of part 807 of this chapter subject to the limitations in § 866.9.

[47 FR 50823, Nov. 9, 1982, as amended at 54 FR 25046, June 12, 1989; 66 FR 38791, July 25, 2001]

**§ 866.3210 Endotoxin assay.**

(a) *Identification*. An endotoxin assay is a device that uses serological techniques in whole blood. The device is intended for use in conjunction with other laboratory findings and clinical assessment of the patient to aid in the risk assessment of critically ill patients for progression to severe sepsis.

(b) *Classification*. Class II (special controls). The special control for this device is the FDA guidance entitled "Class II Special Controls Guidance Document: Endotoxin Assay." See

## § 866.3215

§ 866.1(e) for the availability of this guidance document.

[68 FR 62008, Oct. 31, 2003. Redesignated at 70 FR 53069, Sept. 7, 2005]

### **§ 866.3215 Device to detect and measure non-microbial analyte(s) in human clinical specimens to aid in assessment of patients with suspected sepsis.**

(a) *Identification.* A device to detect and measure non-microbial analyte(s) in human clinical specimens to aid in assessment of patients with suspected sepsis is identified as an in vitro device intended for the detection and qualitative and/or quantitative measurement of one or more non-microbial analytes in human clinical specimens to aid in the assessment of patients with suspected sepsis when used in conjunction with clinical signs and symptoms and other clinical and laboratory findings.

(b) *Classification.* Class II (special controls). The special controls for this device are:

(1) Premarket notification submissions must include the device's detailed Indications for Use statement describing what the device detects and measures, the results provided to the user, whether the measure is qualitative and/or quantitative, the clinical indications for which the test is to be used, and the specific population(s) for which the device use is intended.

(2) Premarket notification submissions must include detailed documentation of the device description, including (as applicable), all device components, software, ancillary reagents required but not provided, explanation of the device principle and methodology, and for molecular devices include detailed documentation of the primer/probe sequence, design, and rationale for sequence selection.

(3) Premarket notification submissions must include detailed documentation of applicable analytical studies, such as, analytical sensitivity (Limit of Detection, Limit of Blank, and Limit of Quantitation), precision, reproducibility, analytical measuring range, interference, cross-reactivity, and specimen stability.

(4) Premarket notification submissions must include detailed docu-

## 21 CFR Ch. I (4–1–20 Edition)

mentation of a prospective clinical study or, if appropriate, results from an equivalent sample set. This detailed documentation must include the following information:

(i) Results must demonstrate adequate device performance relative to a well-accepted comparator.

(ii) Clinical sample results must demonstrate consistency of device output throughout the device measuring range likely to be encountered in the Intended Use population.

(iii) Clinical study documentation must include the original study protocol (including predefined statistical analysis plan), study report documenting support for the Indications for Use(s), and results of all statistical analyses.

(5) Premarket notification submissions must include evaluation of the level of the non-microbial analyte in asymptomatic patients with demographic characteristics (*e.g.*, age, racial, ethnic, and gender distribution) similar to the Intended Use population.

(6) As part of the risk management activities performed under 21 CFR 820.30 design controls, you must document an appropriate end user device training program that will be offered as part of your efforts to mitigate the risk of failure to correctly operate the instrument.

(7) A detailed explanation of the interpretation of results and acceptance criteria must be included in the device's 21 CFR 809.10(b)(9) compliant labeling, and a detailed explanation of the interpretation of the limitations of the samples (*e.g.*, collected on day of diagnosis) must be included in the device's 21 CFR 809.10(b)(10) compliant labeling.

[82 FR 49099, Oct. 24, 2017]

### **§ 866.3220 *Entamoeba histolytica* serological reagents.**

(a) *Identification.* *Entamoeba histolytica* serological reagents are devices that consist of antigens and antisera used in serological tests to identify antibodies to *Entamoeba histolytica* in serum. Additionally, some of these reagents consist of antisera conjugated with a fluorescent dye (immunofluorescent reagents) used to identify *Entamoeba histolytica* directly

from clinical specimens. The identification aids in the diagnosis of amebiasis caused by the microscopic protozoan parasite *Entamoeba histolytica* and provides epidemiological information on diseases caused by this parasite. The parasite may invade the skin, liver, intestines, lungs, and diaphragm, causing disease conditions such as indolent ulcers, an amebic hepatitis, amebic dysentery, and pulmonary lesions.

(b) *Classification*. Class II (special controls). The device is exempt from the premarket notification procedures in subpart E of part 807 of this chapter subject to § 866.9.

[47 FR 50823, Nov. 9, 1982; 47 FR 56846, Dec. 21, 1982, as amended at 63 FR 59226, Nov. 3, 1998]

**§ 866.3225 Enterovirus nucleic acid assay.**

(a) *Identification*. An enterovirus nucleic acid assay is a device that consists of primers, probes, enzymes, and controls for the amplification and detection of enterovirus ribonucleic acid (RNA) in cerebrospinal fluid (CSF) from individuals who have signs and symptoms consistent with meningitis or meningoencephalitis. The detection of enterovirus RNA, in conjunction with other laboratory tests, aids in the clinical laboratory diagnosis of viral meningitis caused by enterovirus.

(b) *Classification*. Class II (special controls). The special control is FDA's guidance document entitled "Class II Special Controls Guidance Document: Nucleic Acid Amplification Assay for the Detection of Enterovirus RNA." See § 866.1(e) for the availability of this guidance document.

[74 FR 8, Jan. 2, 2009]

**§ 866.3235 Epstein-Barr virus serological reagents.**

(a) *Identification*. Epstein-Barr virus serological reagents are devices that consist of antigens and antisera used in serological tests to identify antibodies to Epstein-Barr virus in serum. The identification aids in the diagnosis of Epstein-Barr virus infections and provides epidemiological information on diseases caused by these viruses. Epstein-Barr viruses are thought to cause infectious mononucleosis and have

been associated with Burkitt's lymphoma (a tumor of the jaw in African children and young adults) and postnasal carcinoma (cancer).

(b) *Classification*. Class I (general controls).

**§ 866.3240 Equine encephalomyelitis virus serological reagents.**

(a) *Identification*. Equine encephalomyelitis virus serological reagents are devices that consist of antigens and antisera used in serological tests to identify antibodies to equine encephalomyelitis virus in serum. The identification aids in the diagnosis of diseases caused by equine encephalomyelitis viruses and provides epidemiological information on these viruses. Equine encephalomyelitis viruses are transmitted to humans by the bite of insects, such as mosquitos and ticks, and may cause encephalitis (inflammation of the brain), rash, acute arthritis, or hepatitis.

(b) *Classification*. Class I (general controls). The device is exempt from the premarket notification procedures in subpart E of part 807 of this chapter subject to § 866.9.

[47 FR 50823, Nov. 9, 1982, as amended at 65 FR 2311, Jan. 14, 2000]

**§ 866.3250 *Erysipelothrix rhusiopathiae* serological reagents.**

(a) *Identification*. *Erysipelothrix rhusiopathiae* serological reagents are devices that consist of antigens and antisera used in serological tests to identify *Erysipelothrix rhusiopathiae* from cultured isolates derived from clinical specimens. The identification aids in the diagnosis of disease caused by this bacterium belonging to the genus *Erysipelothrix*. This organism is responsible for a variety of inflammations of the skin following skin abrasions from contact with fish, shellfish, or poultry.

(b) *Classification*. Class I (general controls). The device is exempt from the premarket notification procedures in subpart E of part 807 of this chapter subject to the limitations in § 866.9.

[47 FR 50823, Nov. 9, 1982, as amended at 54 FR 25046, June 12, 1989; 66 FR 38791, July 25, 2001]

**§ 866.3255 *Escherichia coli* serological reagents.**

(a) *Identification.* *Escherichia coli* serological reagents are devices that consist of antigens and antisera used in serological tests to identify *Escherichia coli* from cultured isolates derived from clinical specimens. Additionally, some of these reagents consist of *Escherichia coli* antisera conjugated with a fluorescent dye used to identify *Escherichia coli* directly from clinical specimens or cultured isolates derived from clinical specimens. The identification aids in the diagnosis of diseases caused by this bacterium belonging to the genus *Escherichia*, and provides epidemiological information on diseases caused by this microorganism. Although *Escherichia coli* constitutes the greater part of the microorganisms found in the intestinal tract in humans and is usually non-pathogenic, those strains which are pathogenic may cause urinary tract infections or epidemic diarrheal disease, especially in children.

(b) *Classification.* Class I (general controls). The device is exempt from the premarket notification procedures in subpart E of part 807 of this chapter subject to the limitations in § 866.9.

[47 FR 50823, Nov. 9, 1982, as amended at 54 FR 25046, June 12, 1989; 66 FR 38791, July 25, 2001]

**§ 866.3270 *Flavobacterium* spp. serological reagents.**

(a) *Identification.* *Flavobacterium* spp. serological reagents are devices that consist of antigens and antisera used in serological tests to identify *Flavobacterium* spp. from cultured isolates derived from clinical specimens. The identification aids in the diagnosis of disease caused by bacteria belonging to the genus *Flavobacterium* and provides epidemiological information on diseases caused by these microorganisms. Most members of this genus are found in soil and water and, under certain conditions, may become pathogenic to humans. *Flavobacterium meningosepticum* is highly virulent for the newborn, in whom it may cause epidemics of septicemia (blood poisoning) and meningitis (inflammation of the membranes of the brain) and is usually attributable to contaminated hospital equipment.

(b) *Classification.* Class I (general controls). The device is exempt from the premarket notification procedures in subpart E of part 807 of this chapter subject to the limitations in § 866.9.

[47 FR 50823, Nov. 9, 1982, as amended at 54 FR 25046, June 12, 1989; 66 FR 38792, July 25, 2001]

**§ 866.3280 *Francisella tularensis* serological reagents.**

(a) *Identification.* *Francisella tularensis* serological reagents are devices that consist of antigens and antisera used in serological tests to identify antibodies to *Francisella tularensis* in serum or to identify *Francisella tularensis* in cultured isolates derived from clinical specimens. Additionally, some of these reagents consist of antisera conjugated with a fluorescent dye (immunofluorescent reagents) used to identify *Francisella tularensis* directly from clinical specimens. The identification aids in the diagnosis of tularemia caused by *Francisella tularensis* and provides epidemiological information on this disease. Tularemia is a disease principally of rodents, but may be transmitted to humans through handling of infected animals, animal products, or by the bites of fleas and ticks. The disease takes on several forms depending upon the site of infection, such as skin lesions, lymph node enlargements, or pulmonary infection.

(b) *Classification.* Class II (special controls). The device is exempt from the premarket notification procedures in subpart E of part 807 of this chapter subject to § 866.9.

[47 FR 50823, Nov. 9, 1982, as amended at 63 FR 59226, Nov. 3, 1998]

**§ 866.3290 Gonococcal antibody test (GAT).**

(a) *Identification.* A gonococcal antibody test (GAT) is an in vitro device that consists of the reagents intended to identify by immunochemical techniques, such as latex agglutination, indirect fluorescent antibody, or radioimmunoassay, antibodies to *Neisseria gonorrhoeae* in sera of asymptomatic females at low risk of infection. Identification of antibodies with this device may indicate past or present infection of the patient with *Neisseria gonorrhoeae*.



(b) *Classification.* Class III (premarket approval) (transitional device).

(c) *Date PMA or notice of completion of a PDP is required.* As of May 28, 1976, an approval under section 515 of the act is required before this device may be commercially distributed. See § 866.3.

[47 FR 50823, Nov. 9, 1982, as amended at 52 FR 17734, May 11, 1987]

**§ 866.3300 *Haemophilus* spp. serological reagents.**

(a) *Identification.* *Haemophilus* spp. serological reagents are devices that consist of antigens and antisera, including antisera conjugated with a fluorescent dye, that are used in serological tests to identify *Haemophilus* spp. directly from clinical specimens or tissue culture isolates derived from clinical specimens. The identification aids in the diagnosis of diseases caused by bacteria belonging to the genus *Haemophilus* and provides epidemiological information on diseases caused by these microorganisms. Diseases most often caused by *Haemophilus* spp. include pneumonia, pharyngitis, sinusitis, vaginitis, chancroid venereal disease, and a contagious form of conjunctivitis (inflammation of eyelid membranes).

(b) *Classification.* Class II (special controls). The device is exempt from the premarket notification procedures in subpart E of part 807 of this chapter subject to § 866.9.

[47 FR 50823, Nov. 9, 1982, as amended at 63 FR 59226, Nov. 3, 1998]

**§ 866.3305 Herpes simplex virus serological assays.**

(a) *Identification.* Herpes simplex virus serological assays are devices that consist of antigens and antisera used in various serological tests to identify antibodies to herpes simplex virus in serum. Additionally, some of the assays consist of herpes simplex virus antisera conjugated with a fluorescent dye (immunofluorescent assays) used to identify herpes simplex virus directly from clinical specimens or tissue culture isolates derived from clinical specimens. The identification aids in the diagnosis of diseases caused by herpes simplex viruses and provides epidemiological information on these diseases. Herpes simplex viral infec-

tions range from common and mild lesions of the skin and mucous membranes to a severe form of encephalitis (inflammation of the brain). Neonatal herpes virus infections range from a mild infection to a severe generalized disease with a fatal outcome.

(b) *Classification.* Class II (special controls). The device is classified as class II (special controls). The special control for the device is FDA's revised guidance document entitled "Class II Special Controls Guidance Document: Herpes Simplex Virus Types 1 and 2 Serological Assays." For availability of the guidance revised document, see § 866.1(e).

[72 FR 15830, Apr. 3, 2007, as amended at 74 FR 42775, Aug. 25, 2009; 76 FR 48717, Aug. 9, 2011]

**§ 866.3309 Herpes virus nucleic acid-based cutaneous and mucocutaneous lesion panel.**

(a) *Identification.* A herpes virus nucleic acid-based cutaneous and mucocutaneous lesion panel is a qualitative in vitro diagnostic device intended for the simultaneous detection and differentiation of different herpes viruses in cutaneous and mucocutaneous lesion samples from symptomatic patients suspected of Herpetic infections. Negative results do not preclude infection and should not be used as the sole basis for treatment or other patient management decisions. The assay is not intended for use in cerebrospinal fluid samples.

(b) *Classification.* Class II (special controls). The special controls for this device are:

(1) Premarket notification submissions must include detailed documentation for the device description, including the device components, ancillary reagents required but not provided, and a detailed explanation of the methodology including primer design and selection.

(2) Premarket notification submissions must include detailed documentation from the following analytical and clinical performance studies: Analytical sensitivity (Limit of Detection), reactivity, inclusivity, precision, reproducibility, interference, cross reactivity, carry-over, and cross contamination.

**§ 866.3310**

(3) Premarket notification submissions must include detailed documentation of a clinical study using lesion samples in which Herpes Simplex Virus 1, Herpes Simplex Virus 2, or Varicella Zoster Virus DNA detection was requested. The study must compare the device performance to an appropriate well established reference method.

(4) A detailed explanation of the interpretation of results and acceptance criteria must be included in the device's 21 CFR 809.10(b)(9) compliant labeling.

(5) The device labeling must include a limitation statement that reads: "The device is not intended for use with cerebrospinal fluid or to aid in the diagnosis of HSV or VZV infections of the central nervous system (CNS)."

(6) Premarket notification submissions must include quality assurance protocols and a detailed documentation for device software, including, but not limited to, standalone software applications and hardware-based devices that incorporate software.

(7) The risk management activities performed as part of the manufacturer's 21 CFR 820.30 design controls must document an appropriate end user device training program that will be offered as part of efforts to mitigate the risk of failure to correctly operate the instrument.

[83 FR 52314, Oct. 17, 2018]

**§ 866.3310 Hepatitis A virus (HAV) serological assays.**

(a) *Identification.* HAV serological assays are devices that consist of antigens and antisera for the detection of hepatitis A virus-specific IgM, IgG, or total antibodies (IgM and IgG), in human serum or plasma. These devices are used for testing specimens from individuals who have signs and symptoms consistent with acute hepatitis to determine if an individual has been previously infected with HAV, or as an aid to identify HAV-susceptible individuals. The detection of these antibodies aids in the clinical laboratory diagnosis of an acute or past infection by HAV in conjunction with other clinical laboratory findings. These devices are not intended for screening blood or solid or soft tissue donors.

**21 CFR Ch. I (4–1–20 Edition)**

(b) *Classification.* Class II (special controls). The special control is "Guidance for Industry and FDA Staff: Class II Special Controls Guidance Document: Hepatitis A Virus Serological Assays." See §866.1(e) for the availability of this guidance document.

[71 FR 6679, Feb. 9, 2006]

**§ 866.3320 *Histoplasma capsulatum* serological reagents.**

(a) *Identification.* *Histoplasma capsulatum* serological reagents are devices that consist of antigens and antisera used in serological tests to identify antibodies to *Histoplasma capsulatum* in serum. Additionally, some of these reagents consist of *Histoplasma capsulatum* antisera conjugated with a fluorescent dye (immunofluorescent reagents) used to identify *Histoplasma capsulatum* from clinical specimens or cultured isolates derived from clinical specimens. The identification aids in the diagnosis of histoplasmosis caused by this fungus belonging to the genus *Histoplasma* and provides epidemiological information on the diseases caused by this fungus. Histoplasmosis usually is a mild and often asymptomatic respiratory infection, but in a small number of infected individuals the lesions may spread to practically all tissues and organs.

(b) *Classification.* Class II (special controls). The device is exempt from the premarket notification procedures in subpart E of part 807 of this chapter subject to §866.9.

[47 FR 50823, Nov. 9, 1982, as amended at 63 FR 59227, Nov. 3, 1998]

**§ 866.3328 Influenza virus antigen detection test system.**

(a) *Identification.* An influenza virus antigen detection test system is a device intended for the qualitative detection of influenza viral antigens directly from clinical specimens in patients with signs and symptoms of respiratory infection. The test aids in the diagnosis of influenza infection and provides epidemiological information on influenza. Due to the propensity of the virus to mutate, new strains emerge over time which may potentially affect the performance of these devices. Because influenza is highly

contagious and may lead to an acute respiratory tract infection causing severe illness and even death, the accuracy of these devices has serious public health implications.

(b) *Classification.* Class II (special controls). The special controls for this device are:

(1) The device's sensitivity and specificity performance characteristics or positive percent agreement and negative percent agreement, for each specimen type claimed in the intended use of the device, must meet one of the following two minimum clinical performance criteria:

(i) For devices evaluated as compared to an FDA-cleared nucleic acid based-test or other currently appropriate and FDA accepted comparator method other than correctly performed viral culture method:

(A) The positive percent agreement estimate for the device when testing for influenza A and influenza B must be at the point estimate of at least 80 percent with a lower bound of the 95 percent confidence interval that is greater than or equal to 70 percent.

(B) The negative percent agreement estimate for the device when testing for influenza A and influenza B must be at the point estimate of at least 95 percent with a lower bound of the 95 percent confidence interval that is greater than or equal to 90 percent.

(ii) For devices evaluated as compared to correctly performed viral culture method as the comparator method:

(A) The sensitivity estimate for the device when testing for influenza A must be at the point estimate of at least 90 percent with a lower bound of the 95 percent confidence interval that is greater than or equal to 80 percent. The sensitivity estimate for the device when testing for influenza B must be at the point estimate of at least 80 percent with a lower bound of the 95 percent confidence interval that is greater than or equal to 70 percent.

(B) The specificity estimate for the device when testing for influenza A and influenza B must be at the point estimate of at least 95 percent with a lower bound of the 95 percent confidence interval that is greater than or equal to 90 percent.

(2) When performing testing to demonstrate the device meets the requirements in paragraph (b)(1) of this section, a currently appropriate and FDA accepted comparator method must be used to establish assay performance in clinical studies.

(3) Annual analytical reactivity testing of the device must be performed with contemporary influenza strains. This annual analytical reactivity testing must meet the following criteria:

(i) The appropriate strains to be tested will be identified by FDA in consultation with the Centers for Disease Control and Prevention (CDC) and sourced from CDC or an FDA-designated source. If the annual strains are not available from CDC, FDA will identify an alternative source for obtaining the requisite strains.

(ii) The testing must be conducted according to a standardized protocol considered and determined by FDA to be acceptable and appropriate.

(iii) By July 31 of each calendar year, the results of the last 3 years of annual analytical reactivity testing must be included as part of the device's labeling. If a device has not been on the market long enough for 3 years of annual analytical reactivity testing to have been conducted since the device received marketing authorization from FDA, then the results of every annual analytical reactivity testing since the device received marketing authorization from FDA must be included. The results must be presented as part of the device's labeling in a tabular format, which includes the detailed information for each virus tested as described in the certificate of authentication, either by:

(A) Placing the results directly in the device's § 809.10(b) of this chapter compliant labeling that physically accompanies the device in a separate section of the labeling where the analytical reactivity testing data can be found; or

(B) In the device's label or in other labeling that physically accompanies the device, prominently providing a hyperlink to the manufacturer's public Web site where the analytical reactivity testing data can be found. The manufacturer's home page, as well as the primary part of the manufacturer's Web site that discusses the device,

**§ 866.3330**

must provide a prominently placed hyperlink to the Web page containing this information and must allow unrestricted viewing access.

(4) If one of the actions listed in section 564(b)(1)(A)–(D) of the Federal Food, Drug, and Cosmetic Act occurs with respect to an influenza viral strain, or if the Secretary of Health and Human Services (HHS) determines, under section 319(a) of the Public Health Service Act, that a disease or disorder presents a public health emergency, or that a public health emergency otherwise exists, with respect to an influenza viral strain:

(i) Within 30 days from the date that FDA notifies manufacturers that characterized viral samples are available for test evaluation, the manufacturer must have testing performed on the device with those viral samples in accordance with a standardized protocol considered and determined by FDA to be acceptable and appropriate. The procedure and location of testing may depend on the nature of the emerging virus.

(ii) Within 60 days from the date that FDA notifies manufacturers that characterized viral samples are available for test evaluation and continuing until 3 years from that date, the results of the influenza emergency analytical reactivity testing, including the detailed information for the virus tested as described in the certificate of authentication, must be included as part of the device's labeling in a tabular format, either by:

(A) Placing the results directly in the device's § 809.10(b) of this chapter compliant labeling that physically accompanies the device in a separate section of the labeling where analytical reactivity testing data can be found, but separate from the annual analytical reactivity testing results; or

(B) In a section of the device's label or in other labeling that physically accompanies the device, prominently providing a hyperlink to the manufacturer's public Web site where the analytical reactivity testing data can be found. The manufacturer's home page, as well as the primary part of the manufacturer's Web site that discusses the device, must provide a prominently placed hyperlink to the Web page con-

**21 CFR Ch. I (4–1–20 Edition)**

taining this information and must allow unrestricted viewing access.

[82 FR 3618, Jan. 12, 2017]

**§ 866.3330 Influenza virus serological reagents.**

(a) *Identification.* Influenza virus serological reagents are devices that consist of antigens and antisera used in serological tests to identify antibodies to influenza in serum. The identification aids in the diagnosis of influenza (flu) and provides epidemiological information on influenza. Influenza is an acute respiratory tract disease, which is often epidemic.

(b) *Classification.* Class I (general controls). The device is exempt from the premarket notification procedures in subpart E of part 807 of this chapter subject to the limitations in § 866.9.

[47 FR 50823, Nov. 9, 1982, as amended at 54 FR 25047, June 12, 1989; 66 FR 38792, July 25, 2001]

**§ 866.3332 Reagents for detection of specific novel influenza A viruses.**

(a) *Identification.* Reagents for detection of specific novel influenza A viruses are devices that are intended for use in a nucleic acid amplification test to directly detect specific virus RNA in human respiratory specimens or viral cultures. Detection of specific virus RNA aids in the diagnosis of influenza caused by specific novel influenza A viruses in patients with clinical risk of infection with these viruses, and also aids in the presumptive laboratory identification of specific novel influenza A viruses to provide epidemiological information on influenza. These reagents include primers, probes, and specific influenza A virus controls.

(b) *Classification.* Class II (special controls). The special controls are:

(1) FDA's guidance document entitled "Class II Special Controls Guidance Document: Reagents for Detection of Specific Novel Influenza A Viruses." See § 866.1(e) for information on obtaining this document.

(2) The distribution of these devices is limited to laboratories with experienced personnel who have training in standardized molecular testing procedures and expertise in viral diagnosis,

and appropriate biosafety equipment and containment.

[71 FR 14379, Mar. 22, 2006]

**§ 866.3336 John Cunningham Virus serological reagents.**

(a) *Identification.* John Cunningham Virus serological reagents are devices that consist of antigens and antisera used in serological assays to identify antibodies to John Cunningham Virus in serum and plasma. The identification aids in the risk stratification for the development of progressive multifocal leukoencephalopathy in multiple sclerosis and Crohn's disease patients undergoing natalizumab therapy. These devices are for adjunctive use, in the context of other clinical risk factors for the development of progressive multifocal leukoencephalopathy.

(b) *Classification.* Class II (special controls). The special control for this device is the FDA guideline document entitled "Class II Special Controls Guideline: John Cunningham Virus Serological Reagents." For availability of the guideline document, see § 866.1(e).

[79 FR 3740, Jan. 23, 2014]

**§ 866.3340 Klebsiella spp. serological reagents.**

(a) *Identification.* *Klebsiella* spp. serological reagents are devices that consist of antigens and antisera, including antisera conjugated with a fluorescent dye (immunofluorescent reagents), that are used in serological tests to identify *Klebsiella* spp. from cultured isolates derived from clinical specimens. The identification aids in the diagnosis of diseases caused by bacteria belonging to the genus *Klebsiella* and provides epidemiological information on these diseases. These organisms can cause serious urinary tract and pulmonary infections, particularly in hospitalized patients.

(b) *Classification.* Class I (general controls). The device is exempt from the premarket notification procedures in subpart E of part 807 of this chapter subject to the limitations in § 866.9.

[47 FR 50823, Nov. 9, 1982, as amended at 54 FR 25047, June 12, 1989; 66 FR 38792, July 25, 2001]

**§ 866.3350 Leptospira spp. serological reagents.**

(a) *Identification.* *Leptospira* spp. serological reagents are devices that consist of antigens and antisera used in serological tests to identify antibodies to *Leptospira* spp. in serum or identify *Leptospira* spp. from cultured isolates derived from clinical specimens. Additionally, some of these antisera are conjugated with a fluorescent dye (immunofluorescent reagents) and used to identify *Leptospira* spp. directly from clinical specimens. The identification aids in the diagnosis of leptospirosis caused by bacteria belonging to the genus *Leptospira* and provides epidemiological information on this disease. *Leptospira* infections range from mild fever-producing illnesses to severe liver and kidney involvement producing hemorrhage and dysfunction of these organs.

(b) *Classification.* Class II (special controls). The device is exempt from the premarket notification procedures in subpart E of part 807 of this chapter subject to § 866.9.

[47 FR 50823, Nov. 9, 1982, as amended at 63 FR 59227, Nov. 3, 1998]

**§ 866.3355 Listeria spp. serological reagents.**

(a) *Identification.* *Listeria* spp. serological reagents are devices that consist of antigens and antisera used in serological tests to identify *Listeria* spp. from cultured isolates derived from clinical specimens. Additionally, some of these reagents consist of *Listeria* spp. antisera conjugated with a fluorescent dye (immunofluorescent reagents) used to identify *Listeria* spp. directly from clinical specimens. The identification aids in the diagnosis of listeriosis, a disease caused by bacteria belonging to the genus *Listeria*, and provides epidemiological information on diseases caused by these microorganisms. *Listeria monocytogenes*, the most common human pathogen of this genus, causes meningitis (inflammation of the brain membranes) and meningoenzephalitis (inflammation of the brain and brain membranes) and is often fatal if untreated. A second form of human listeriosis is an intrauterine infection in pregnant women that results in a

**§ 866.3360**

**21 CFR Ch. I (4–1–20 Edition)**

high mortality rate for infants before or after birth.

(b) *Classification.* Class I (general controls). The device is exempt from the premarket notification procedures in subpart E of part 807 of this chapter subject to § 866.9.

[47 FR 50823, Nov. 9, 1982, as amended at 65 FR 2311, Jan. 14, 2000]

**§ 866.3360 Lymphocytic choriomeningitis virus serological reagents.**

(a) *Identification.* Lymphocytic choriomeningitis virus serological reagents are devices that consist of antigens and antisera used in serological tests to identify antibodies to lymphocytic choriomeningitis virus in serum. The identification aids in the diagnosis of lymphocytic choriomeningitis virus infections and provides epidemiological information on diseases caused by these viruses. Lymphocytic choriomeningitis viruses usually cause a mild cerebral meningitis (inflammation of membranes that envelop the brain) and occasionally a mild pneumonia, but in rare instances may produce severe and even fatal illnesses due to complications from cerebral meningitis and pneumonia.

(b) *Classification.* Class I (general controls). The device is exempt from the premarket notification procedures in subpart E of part 807 of this chapter subject to § 866.9.

[47 FR 50823, Nov. 9, 1982, as amended at 65 FR 2311, Jan. 14, 2000]

**§ 866.3361 Mass spectrometer system for clinical use for the identification of microorganisms.**

(a) *Identification.* A mass spectrometer system for clinical use for the identification of microorganisms is a qualitative in vitro diagnostic device intended for the identification of microorganisms cultured from human specimens. The device is comprised of an ionization source, a mass analyzer, and a spectral database. The device is indicated for use in conjunction with other clinical and laboratory findings to aid in the diagnosis of bacterial and fungal infections.

(b) *Classification.* Class II (special controls). The special controls for this device are:

(1) Premarket notification submissions must include detailed documentation for device software, including, but not limited to, standalone software applications and hardware-based devices that incorporate software.

(2) Premarket notification submissions must include database implementation methodology, construction parameters, and quality assurance protocols.

(3) A detailed explanation of the interpretation of results and acceptance criteria must be included in the device's 21 CFR 809.10(b)(9) compliant labeling.

(4) As part of the risk management activities performed as part of your 21 CFR 820.30 design controls, you must document an appropriate end user device training program that will be offered as part of your efforts to mitigate the risk of failure to correctly operate the instrument.

(5) Premarket notification submissions must include details on the appropriate end user device training program that will be offered while marketing the device.

[82 FR 49101, Oct. 24, 2017]

**§ 866.3365 Multiplex nucleic acid assay for identification of microorganisms and resistance markers from positive blood cultures.**

(a) *Identification.* A multiplex nucleic acid assay for identification of microorganisms and resistance markers from positive blood cultures is a qualitative in vitro device intended to simultaneously detect and identify microorganism nucleic acids from blood cultures that test positive by Gram stain or other microbiological stains. The device detects specific nucleic acid sequences for microorganism identification as well as for antimicrobial resistance. This device aids in the diagnosis of bloodstream infections when used in conjunction with other clinical and laboratory findings. However, the device does not replace traditional methods for culture and susceptibility testing.

(b) *Classification.* Class II (special controls). The special control for this

device is FDA's guideline document entitled "Class II Special Controls Guideline: Multiplex Nucleic Acid Assay for Identification of Microorganisms and Resistance Markers from Positive Blood Cultures." For availability of the guideline document, see § 866.1(e).

[80 FR 30154, May 27, 2015]

**§ 866.3370 *Mycobacterium tuberculosis* immunofluorescent reagents.**

(a) *Identification.* *Mycobacterium tuberculosis* immunofluorescent reagents are devices that consist of antisera conjugated with a fluorescent dye used to identify *Mycobacterium tuberculosis* directly from clinical specimens. The identification aids in the diagnosis of tuberculosis and provides epidemiological information on this disease. *Mycobacterium tuberculosis* is the common causative organism in human tuberculosis, a chronic infectious disease characterized by formation of tubercles (small rounded nodules) and tissue necrosis (destruction), usually occurring in the lung.

(b) *Classification.* Class I (general controls).

**§ 866.3372 Nucleic acid-based in vitro diagnostic devices for the detection of *Mycobacterium tuberculosis* complex in respiratory specimens.**

(a) *Identification.* Nucleic acid-based in vitro diagnostic devices for the detection of *Mycobacterium tuberculosis* complex in respiratory specimens are qualitative nucleic acid-based in vitro diagnostic devices intended to detect *Mycobacterium tuberculosis* complex nucleic acids extracted from human respiratory specimens. These devices are non-multiplexed and intended to be used as an aid in the diagnosis of pulmonary tuberculosis when used in conjunction with clinical and other laboratory findings. These devices do not include devices intended to detect the presence of organism mutations associated with drug resistance. Respiratory specimens may include sputum (induced or expectorated), bronchial specimens (e.g., bronchoalveolar lavage or bronchial aspirate), or tracheal aspirates.

(b) *Classification.* Class II (special controls). The special control for this device is the FDA document entitled

"Class II Special Controls Guideline: Nucleic Acid-Based In Vitro Diagnostic Devices for the Detection of *Mycobacterium tuberculosis* Complex in Respiratory Specimens." For availability of the guideline document, see § 866.1(e).

[79 FR 31027, May 30, 2014]

**§ 866.3373 Nucleic acid-based in vitro diagnostic devices for the detection of *Mycobacterium tuberculosis* complex (MTB-complex) and the genetic mutations associated with MTB-complex antibiotic resistance in respiratory specimens.**

(a) *Identification.* Nucleic acid-based in vitro diagnostic devices for the detection of *Mycobacterium tuberculosis* complex (MTB-complex) and the genetic mutations associated with MTB-complex antibiotic resistance in respiratory specimens are qualitative nucleic acid-based devices that detect the presence of MTB-complex-associated nucleic acid sequences in respiratory samples. These devices are intended to aid in the diagnosis of pulmonary tuberculosis and the selection of an initial treatment regimen when used in conjunction with clinical findings and other laboratory results. These devices do not provide confirmation of antibiotic susceptibility since other mechanisms of resistance may exist that may be associated with a lack of clinical response to treatment other than those detected by the device.

(b) *Classification.* Class II (special controls). The special controls for this device are:

(1) The FDA document entitled "Class II Special Controls Guideline: Nucleic Acid-Based In Vitro Diagnostic Devices for the Detection of *Mycobacterium tuberculosis* Complex and Genetic Mutations Associated with Antibiotic Resistance in Respiratory Specimens," which addresses the mitigation of risks specific to the detection of MTB-complex. For availability of the document, see § 866.1(e).

(2) The following items, which address the mitigation of risks specific to the detection of the genetic mutations associated with antibiotic resistance of MTB-complex:

(i) The device must include an external positive assay control as appropriate. Acceptable positive assay controls include MTB-complex isolates containing one or more antibiotic-resistance associated target sequences detected by the device.

(ii) The device must include internal controls as appropriate. An acceptable internal control may include human nucleic acid co-extracted with MTB-complex containing nucleic acid sequences associated with antibiotic resistance and primers amplifying human housekeeping genes (e.g., RNaseP,  $\beta$ -actin).

(iii) The device's intended use must include a description of the scope of antibiotic resistance targeted by the assay, i.e., the specific drugs and/or drug classes.

(iv) The specific performance characteristics section of the device's labeling must include information regarding the specificity of the assay oligonucleotides for detecting mutations associated with antibiotic resistance of MTB-complex, and any information indicating the potential for non-specific binding (e.g., BLAST search).

(v) In demonstrating device performance you must perform:

(A) Pre-analytical studies that evaluate:

(1) *Frozen samples.* If there is use of any frozen samples in the device performance studies, or if there is a device claim for the use of frozen samples for testing, the effect of freezing samples prior to testing and the effect of multiple freeze/thaw cycles on both antibiotic susceptible and antibiotic resistant strains of MTB-complex.

(2) *Nucleic acid extraction methods.* Extraction methods must parallel those used in devices for the detection of MTB-complex nucleic acid and confirm that the detection of the genetic mutations associated with antibiotic resistance is not affected.

(B) Analytical studies that analyze:

(1) *Limit of Detection.* Limit of Detection must be determined in the most challenging matrix (e.g., sputum) claimed for use with the device. The Limit of Detection must be determined using both antibiotic susceptible and antibiotic resistant strains of MTB-

complex. The antibiotic resistant strains must be those with well characterized genetic mutations associated with antibiotic resistance.

(2) *Analytical Reactivity (Inclusivity).* Testing must be conducted to evaluate the ability of the device to detect genetic mutations associated with antibiotic resistance in a diversity of MTB-complex strains. Isolates used in testing must be well characterized. Isolate strain characterization must be determined using standardized reference methods recognized by a reputable scientific body and appropriate to the strain lineage.

(3) *Within-Laboratory (Repeatability) Precision Testing.* Within-laboratory precision studies, if appropriate, must include at least one antibiotic resistant and one antibiotic susceptible strain of MTB-complex.

(4) *Between Laboratory Reproducibility Testing.* The protocol for the reproducibility study may vary slightly depending on the assay format; however, the panel must include at least one antibiotic resistant and one antibiotic susceptible strain of MTB-complex.

(C) *Clinical Studies.* Clinical performance of the device must be established by conducting prospective clinical studies that include subjects with culture confirmed active tuberculosis. Studies must attempt to enroll subjects at risk for antibiotic-resistant MTB-complex; however, it may be necessary to include supplemental antibiotic resistant retrospective and contrived samples. Clinical studies must compare device results to both phenotypic drug susceptibility testing and genotypic reference methods. The genotypic reference method must be a polymerase chain reaction based method that uses primers different from those in the experimental device and confirmed by bidirectional sequencing.

[79 FR 63036, Oct. 22, 2014]

#### § 866.3375 *Mycoplasma* spp. serological reagents.

(a) *Identification.* *Mycoplasma* spp. serological reagents are devices that consist of antigens and antisera used in serological tests to identify antibodies to *Mycoplasma* spp. in serum. Additionally, some of these reagents consist of *Mycoplasma* spp. antisera conjugated



with a fluorescent dye (immunofluorescent reagents) used to identify *Mycoplasma* spp. directly from clinical specimens. The identification aids in the diagnosis of disease caused by bacteria belonging to the genus *Mycoplasma* and provides epidemiological information on diseases caused by these microorganisms. *Mycoplasma* spp. are associated with inflammatory conditions of the urinary and respiratory tracts, the genitals, and the mouth. The effects in humans of infection with *Mycoplasma pneumoniae* range from inapparent infection to mild or severe upper respiratory disease, ear infection, and bronchial pneumonia.

(b) *Classification*. Class I (general controls). The device is exempt from the premarket notification procedures in subpart E of part 807 of this chapter subject to § 866.9.

[47 FR 50823, Nov. 9, 1982, as amended at 65 FR 2311, Jan. 14, 2000]

**§ 866.3380 Mumps virus serological reagents.**

(a) *Identification*. Mumps virus serological reagents consist of antigens and antisera used in serological tests to identify antibodies to mumps virus in serum. Additionally, some of these reagents consist of antisera conjugated with a fluorescent dye (immunofluorescent reagents) used in serological tests to identify mumps viruses from tissue culture isolates derived from clinical specimens. The identification aids in the diagnosis of mumps and provides epidemiological information on mumps. Mumps is an acute contagious disease, particularly in children, characterized by an enlargement of one or both of the parotid glands (glands situated near the ear), although other organs may also be involved.

(b) *Classification*. Class I (general controls). The device is exempt from the premarket notification procedures in subpart E of part 807 of this chapter subject to § 866.9.

[47 FR 50823, Nov. 9, 1982, as amended at 65 FR 2311, Jan. 14, 2000]

**§ 866.3390 *Neisseria* spp. direct serological test reagents.**

(a) *Identification*. *Neisseria* spp. direct serological test reagents are devices

that consist of antigens and antisera used in serological tests to identify *Neisseria* spp. from cultured isolates. Additionally, some of these reagents consist of *Neisseria* spp. antisera conjugated with a fluorescent dye (immunofluorescent reagents) which may be used to detect the presence of *Neisseria* spp. directly from clinical specimens. The identification aids in the diagnosis of disease caused by bacteria belonging to the genus *Neisseria*, such as epidemic cerebrospinal meningitis, meningococcal disease, and gonorrhoea, and also provides epidemiological information on diseases caused by these microorganisms. The device does not include products for the detection of gonorrhoea in humans by indirect methods, such as detection of antibodies or of oxidase produced by gonococcal organisms.

(b) *Classification*. Class II (performance standards).

**§ 866.3395 Norovirus serological reagents.**

(a) *Identification*. Norovirus serological reagents are devices that consist of antigens and antisera used in serological tests to detect the presence of norovirus antigens in fecal samples. These devices aid in the diagnosis of norovirus infection in the setting of an individual patient with symptoms of acute gastroenteritis when the individual patient is epidemiologically linked to other patients with symptoms of acute gastroenteritis and/or aid in the identification of norovirus as the etiology of an outbreak of acute gastroenteritis in the setting of epidemiologically linked patients with symptoms of acute gastroenteritis.

(b) *Classification*. Class II (special controls). The device is exempt from the premarket notification procedures in subpart E of part 807 of this chapter subject to the limitations in § 866.9. The special control is FDA's guidance document entitled "Class II Special Controls Guidance Document: Norovirus Serological Reagents." See § 866.1(e) for the availability of this guidance document.

[76 FR 14274, Mar. 9, 2012, as amended at 84 FR 71800, Dec. 30, 2019]

## § 866.3400

### § 866.3400 Parainfluenza virus serological reagents.

(a) *Identification.* Parainfluenza virus serological reagents are devices that consist of antigens and antisera used in serological tests to identify antibodies to parainfluenza virus in serum. The identification aids in the diagnosis of parainfluenza virus infections and provides epidemiological information on diseases caused by these viruses. Parainfluenza viruses cause a variety of respiratory illnesses ranging from the common cold to pneumonia.

(b) *Classification.* Class I (general controls). The device is exempt from the premarket notification procedures in subpart E of part 807 of this chapter subject to the limitations in § 866.9.

[47 FR 50823, Nov. 9, 1982, as amended at 54 FR 25047, June 12, 1989; 66 FR 38792, July 25, 2001]

### § 866.3402 Plasmodium species antigen detection assays.

(a) *Identification.* A *Plasmodium* species antigen detection assay is a device that employs antibodies for the detection of specific malaria parasite antigens, including histidine-rich protein-2 (HRP2) specific antigens, and pan malarial antigens in human whole blood. These devices are used for testing specimens from individuals who have signs and symptoms consistent with malaria infection. The detection of these antigens aids in the clinical laboratory diagnosis of malaria caused by the four malaria species capable of infecting humans: *Plasmodium falciparum*, *Plasmodium vivax*, *Plasmodium ovale*, and *Plasmodium malariae*, and aids in the differential diagnosis of *Plasmodium falciparum* infections from other less virulent *Plasmodium* species. The device is intended for use in conjunction with other clinical laboratory findings.

(b) *Classification.* Class II (special controls). The special control is FDA's guidance document entitled "Class II Special Controls Guidance Document: *Plasmodium* species Antigen Detection Assays." See § 866.1(e) for the availability of this guidance document.

[73 FR 29054, May 20, 2008]

## 21 CFR Ch. I (4–1–20 Edition)

### § 866.3405 Poliovirus serological reagents.

(a) *Identification.* Poliovirus serological reagents are devices that consist of antigens and antisera used in serological tests to identify antibodies to poliovirus in serum. Additionally, some of these reagents consist of poliovirus antisera conjugated with a fluorescent dye (immunofluorescent reagents) used to identify polioviruses from clinical specimens or from tissue culture isolates derived from clinical specimens. The identification aids in the diagnosis of poliomyelitis (polio) and provides epidemiological information on this disease. Poliomyelitis is an acute infectious disease which in its serious form affects the central nervous system resulting in atrophy (wasting away) of groups of muscles, ending in contraction and permanent deformity.

(b) *Classification.* Class I (general controls). The device is exempt from the premarket notification procedures in subpart E of part 807 of this chapter subject to § 866.9.

[47 FR 50823, Nov. 9, 1982, as amended at 65 FR 2312, Jan. 14, 2000]

### § 866.3410 *Proteus* spp. (Weil-Felix) serological reagents.

(a) *Identification.* *Proteus* spp. (Weil-Felix) serological reagents are devices that consist of antigens and antisera, including antisera conjugated with a fluorescent dye (immunofluorescent reagents), derived from the bacterium *Proteus vulgaris* used in agglutination tests (a specific type of antigen-antibody reaction) for the detection of antibodies to rickettsia (virus-like bacteria) in serum. Test results aid in the diagnosis of diseases caused by bacteria belonging to the genus *Rickettsiae* and provide epidemiological information on these diseases. Rickettsia are generally transmitted by arthropods (e.g., ticks and mosquitoes) and produce infections in humans characterized by rash and fever (e.g., typhus fever, spotted fever, Q fever, and trench fever).

(b) *Classification.* Class I (general controls). The device is exempt from the premarket notification procedures in

subpart E of part 807 of this chapter subject to the limitations in § 866.9.

[47 FR 50823, Nov. 9, 1982, as amended at 54 FR 25047, June 12, 1989; 66 FR 38792, July 25, 2001]

**§ 866.3415 *Pseudomonas* spp. serological reagents.**

(a) *Identification.* *Pseudomonas* spp. serological reagents are devices that consist of antigens and antisera, including antisera conjugated with a fluorescent dye (immunofluorescent reagents), used to identify *Pseudomonas* spp. from clinical specimens or from cultured isolates derived from clinical specimens. The identification aids in the diagnosis of disease caused by bacteria belonging to the genus *Pseudomonas*. *Pseudomonas aeruginosa* is a major cause of hospital-acquired infections, and has been associated with urinary tract infections, eye infections, burn and wound infections, blood poisoning, abscesses, and meningitis (inflammation of brain membranes). *Pseudomonas pseudomallei* causes melioidosis, a chronic pneumonia.

(b) *Classification.* Class II (special controls). The device is exempt from the premarket notification procedures in subpart E of part 807 of this chapter subject to § 866.9.

[47 FR 50823, Nov. 9, 1982, as amended at 63 FR 59227, Nov. 3, 1998]

**§ 866.3460 Rabiesvirus immunofluorescent reagents.**

(a) *Identification.* Rabiesvirus immunofluorescent reagents are devices that consist of rabiesvirus antisera conjugated with a fluorescent dye used to identify rabiesvirus in specimens taken from suspected rabid animals. The identification aids in the diagnosis of rabies in patients exposed by animal bites and provides epidemiological information on rabies. Rabies is an acute infectious disease of the central nervous system which, if undiagnosed, may be fatal. The disease is commonly transmitted to humans by a bite from a rabid animal.

(b) *Classification.* Class II (performance standards).

**§ 866.3470 Reovirus serological reagents.**

(a) *Identification.* Reovirus serological reagents are devices that consist of antigens and antisera used in serological tests to identify antibodies to reovirus in serum. The identification aids in the diagnosis of reovirus infections and provides epidemiological information on diseases caused by these viruses. Reoviruses are thought to cause only mild respiratory and gastrointestinal illnesses.

(b) *Classification.* Class I (general controls). The device is exempt from the premarket notification procedures in subpart E of part 807 of this chapter subject to the limitations in § 866.9.

[47 FR 50823, Nov. 9, 1982, as amended at 54 FR 25047, June 12, 1989; 66 FR 38792, July 25, 2001]

**§ 866.3480 Respiratory syncytial virus serological reagents.**

(a) *Identification.* Respiratory syncytial virus serological reagents are devices that consist of antigens and antisera used in serological tests to identify antibodies to respiratory syncytial virus in serum. Additionally, some of these reagents consist of respiratory syncytial virus antisera conjugated with a fluorescent dye (immunofluorescent reagents) and used to identify respiratory syncytial viruses from clinical specimens or from tissue culture isolates derived from clinical specimens. The identification aids in the diagnosis of respiratory syncytial virus infections and provides epidemiological information on diseases caused by these viruses. Respiratory syncytial viruses cause a number of respiratory tract infections, including the common cold, pharyngitis, and infantile bronchopneumonia.

(b) *Classification.* Class I (general controls). The device is exempt from the premarket notification procedures in subpart E of part 807 of this chapter subject to § 866.9.

[47 FR 50823, Nov. 9, 1982, as amended at 65 FR 2312, Jan. 14, 2000]

**§ 866.3490 Rhinovirus serological reagents.**

(a) *Identification.* Rhinovirus serological reagents are devices that consist of antigens and antisera used in serological tests to identify antibodies to rhinovirus in serum. The identification aids in the diagnosis of rhinovirus infections and provides epidemiological information on diseases caused by these viruses. Rhinoviruses cause common colds.

(b) *Classification.* Class I (general controls). The device is exempt from the premarket notification procedures in subpart E of part 807 of this chapter subject to the limitations in § 866.9.

[47 FR 50823, Nov. 9, 1982, as amended at 54 FR 25047, June 12, 1989; 66 FR 38792, July 25, 2001]

**§ 866.3500 Rickettsia serological reagents.**

(a) *Identification.* Rickettsia serological reagents are devices that consist of antigens and antisera used in serological tests to identify antibodies to rickettsia in serum. Additionally, some of these reagents consist of rickettsial antisera conjugated with a fluorescent dye (immunofluorescent reagents) used to identify rickettsia directly from clinical specimens. The identification aids in the diagnosis of diseases caused by virus-like bacteria belonging to the genus *Rickettsia* and provides epidemiological information on these diseases. Rickettsia are generally transmitted by arthropods (e.g., ticks and mosquitoes) and produce infections in humans characterized by rash and fever (e.g., typhus fever, spotted fever, Q fever, and trench fever).

(b) *Classification.* Class I (general controls). The device is exempt from the premarket notification procedures in subpart E of part 807 of this chapter subject to § 866.9.

[47 FR 50823, Nov. 9, 1982, as amended at 65 FR 2312, Jan. 14, 2000]

**§ 866.3510 Rubella virus serological reagents.**

(a) *Identification.* Rubella virus serological reagents are devices that consist of antigens and antisera used in serological tests to identify antibodies to rubella virus in serum. The identifica-

tion aids in the diagnosis of rubella (German measles) or confirmation of a person's immune status from past infections or immunizations and provides epidemiological information on German measles. Newborns infected in the uterus with rubella virus may be born with multiple congenital defects (rubella syndrome).

(b) *Classification.* Class II. The special controls for this device are:

(1) National Committee for Clinical Laboratory Standards':

(i) 1/LA6 "Detection and Quantitation of Rubella IgG Antibody: Evaluation and Performance Criteria for Multiple Component Test Products, Specimen Handling, and Use of the Test Products in the Clinical Laboratory, October 1997,"

(ii) 1/LA18 "Specifications for Immunological Testing for Infectious Diseases, December 1994,"

(iii) D13 "Agglutination Characteristics, Methodology, Limitations, and Clinical Validation, October 1993,"

(iv) EP5 "Evaluation of Precision Performance of Clinical Chemistry Devices, February 1999," and

(v) EP10 "Preliminary Evaluation of the Linearity of Quantitative Clinical Laboratory Methods, May 1998,"

(2) Centers for Disease Control's:

(i) Low Titer Rubella Standard,

(ii) Reference Panel of Well Characterized Rubella Sera, and

(3) World Health Organization's International Rubella Standard.

[47 FR 50823, Nov. 9, 1982, as amended at 52 FR 17734, May 11, 1987; 65 FR 17144, Mar. 31, 2000]

**§ 866.3520 Rubeola (measles) virus serological reagents.**

(a) *Identification.* Rubeola (measles) virus serological reagents are devices that consist of antigens and antisera used in serological tests to identify antibodies to rubeola virus in serum. The identification aids in the diagnosis of measles and provides epidemiological information on the disease. Measles is an acute, highly infectious disease of the respiratory and reticuloendothelial tissues, particularly in children, characterized by a confluent and blotchy rash.

(b) *Classification.* Class I (general controls). The device is exempt from the

premarket notification procedures in subpart E of part 807 of this chapter subject to the limitations in § 866.9.

[47 FR 50823, Nov. 9, 1982, as amended at 54 FR 25047, June 12, 1989; 66 FR 38792, July 25, 2001]

**§ 866.3550 *Salmonella* spp. serological reagents.**

(a) *Identification.* *Salmonella* spp. serological reagents are devices that consist of antigens and antisera used in serological tests to identify *Salmonella* spp. from cultured isolates derived from clinical specimens. Additionally, some of these reagents consist of antisera conjugated with a fluorescent dye (immunofluorescent reagents) used to identify *Salmonella* spp. directly from clinical specimens or cultured isolates derived from clinical specimens. The identification aids in the diagnosis of salmonellosis caused by bacteria belonging to the genus *Salmonella* and provides epidemiological information on this disease. Salmonellosis is characterized by high grade fever (“enteric fever”), severe diarrhea, and cramps.

(b) *Classification.* Class II (special controls). The device is exempt from the premarket notification procedures in subpart E of part 807 of this chapter subject to § 866.9.

[47 FR 50823, Nov. 9, 1982, as amended at 63 FR 59227, Nov. 3, 1998]

**§ 866.3600 *Schistosoma* spp. serological reagents.**

(a) *Identification.* *Schistosoma* spp. serological reagents are devices that consist of antigens and antisera used in serological tests to identify antibodies to *Schistosoma* spp. in serum. The identification aids in the diagnosis of schistosomiasis caused by parasitic flatworms of the genus *Schistosoma*. Schistosomiasis is characterized by a variety of acute and chronic infections. Acute infection is marked by fever, allergic symptoms, and diarrhea. Chronic effects are usually severe and are caused by fibrous degeneration of tissue around deposited eggs of the parasite in the liver, lungs, and central nervous system. Schistosomes can also cause schistosome dermatitis (e.g., swimmer’s itch), a skin disease marked by intense itching.

(b) *Classification.* Class I (general controls). The device is exempt from the premarket notification procedures in subpart E of part 807 of this chapter subject to § 866.9.

[47 FR 50823, Nov. 9, 1982, as amended at 65 FR 2312, Jan. 14, 2000]

**§ 866.3630 *Serratia* spp. serological reagents.**

(a) *Identification.* *Serratia* spp. serological reagents are devices that consist of antigens and antisera used in serological tests to identify *Serratia* spp. from cultured isolates. The identification aids in the diagnosis of disease caused by bacteria belonging to the genus *Serratia* and provides epidemiological information on these diseases. *Serratia* spp. are occasionally associated with gastroenteritis (food poisoning) and wound infections.

(b) *Classification.* Class I (general controls). The device is exempt from the premarket notification procedures in subpart E of part 807 of this chapter subject to the limitations in § 866.9.

[47 FR 50823, Nov. 9, 1982, as amended at 54 FR 25047, June 12, 1989; 66 FR 38792, July 25, 2001]

**§ 866.3660 *Shigella* spp. serological reagents.**

(a) *Identification.* *Shigella* spp. serological reagents are devices that consist of antigens and antisera, including antisera conjugated with a fluorescent dye (immunofluorescent reagents), used in serological tests to identify *Shigella* spp. from cultured isolates. The identification aids in the diagnosis of shigellosis caused by bacteria belonging to the genus *Shigella* and provides epidemiological information on this disease. Shigellosis is characterized by abdominal pain, cramps, diarrhea, and fever.

(b) *Classification.* Class II (special controls). The device is exempt from the premarket notification procedures in subpart E of part 807 of this chapter subject to § 866.9.

[47 FR 50823, Nov. 9, 1982, as amended at 63 FR 59227, Nov. 3, 1998]

**§ 866.3680 *Sporothrix schenckii* serological reagents.**

(a) *Identification.* *Sporothrix schenckii* serological reagents are devices that consist of antigens and antisera used in serological tests to identify antibodies to *Sporothrix schenckii* in serum. The identification aids in the diagnosis of sporothrichosis caused by a fungus belonging to the genus *Sporothrix* and provides epidemiological information on this disease. Sporothrichosis is a chronic tumorlike infection primarily of the skin.

(b) *Classification.* Class I (general controls). The device is exempt from the premarket notification procedures in subpart E of part 807 of this chapter subject to § 866.9.

[47 FR 50823, Nov. 9, 1982, as amended at 65 FR 2312, Jan. 14, 2000]

**§ 866.3700 *Staphylococcus aureus* serological reagents.**

(a) *Identification.* *Staphylococcus aureus* serological reagents are devices that consist of antigens and antisera used in serological tests to identify enterotoxin (toxin affecting the intestine) producing staphylococci from cultured isolates. The identification aids in the diagnosis of disease caused by this bacterium belonging to the genus *Staphylococcus* and provides epidemiological information on these diseases. Certain strains of *Staphylococcus aureus* produce an enterotoxin while growing in meat, dairy, or bakery products. After ingestion, this enterotoxin is absorbed in the gut and causes destruction of the intestinal lining (gastroenteritis).

(b) *Classification.* Class I (general controls). The device is exempt from the premarket notification procedures in subpart E of part 807 of this chapter subject to the limitations in § 866.9.

[47 FR 50823, Nov. 9, 1982, as amended at 54 FR 25047, June 12, 1989; 66 FR 38792, July 25, 2001]

**§ 866.3720 *Streptococcus* spp. exoenzyme reagents.**

(a) *Identification.* *Streptococcus* spp. exoenzyme reagents are devices used to identify antibodies to *Streptococcus* spp. exoenzyme in serum. The identification aids in the diagnosis of disease

caused by bacteria belonging to the genus *Streptococcus* and provides epidemiological information on these diseases. Pathogenic streptococci are associated with infections, such as sore throat, impetigo (an infection characterized by small pustules on the skin), urinary tract infections, rheumatic fever, and kidney disease.

(b) *Classification.* Class I (general controls). The device is exempt from the premarket notification procedures in subpart E of part 807 of this chapter subject to the limitations in § 866.9.

[47 FR 50823, Nov. 9, 1982, as amended at 61 FR 1119, Jan. 16, 1996; 66 FR 38792, July 25, 2001]

**§ 866.3740 *Streptococcus* spp. serological reagents.**

(a) *Identification.* *Streptococcus* spp. serological reagents are devices that consist of antigens and antisera (excluding streptococcal exoenzyme reagents made from enzymes secreted by streptococci) used in serological tests to identify *Streptococcus* spp. from cultured isolates derived from clinical specimens. The identification aids in the diagnosis of diseases caused by bacteria belonging to the genus *Streptococcus* and provides epidemiological information on these diseases. Pathogenic streptococci are associated with infections, such as sore throat, impetigo (an infection characterized by small pustules on the skin), urinary tract infections, rheumatic fever, and kidney disease.

(b) *Classification.* Class I (general controls). The device is exempt from the premarket notification procedures in subpart E of part 807 of this chapter subject to § 866.9.

[47 FR 50823, Nov. 9, 1982, as amended at 65 FR 2312, Jan. 14, 2000]

**§ 866.3780 *Toxoplasma gondii* serological reagents.**

(a) *Identification.* *Toxoplasma gondii* serological reagents are devices that consist of antigens and antisera used in serological tests to identify antibodies to *Toxoplasma gondii* in serum. Additionally, some of these reagents consist of antisera conjugated with a fluorescent dye (immunofluorescent reagents) used to identify *Toxoplasma gondii* from clinical specimens. The identification

aids in the diagnosis of toxoplasmosis caused by the parasitic protozoan *Toxoplasma gondii* and provides epidemiological information on this disease. Congenital toxoplasmosis is characterized by lesions of the central nervous system, which if undetected and untreated may lead to brain defects, blindness, and death of an unborn fetus. The disease is characterized in children by inflammation of the brain and spinal cord.

(b) *Classification*. Class II (performance standards).

**§ 866.3820 *Treponema pallidum* nontreponemal test reagents.**

(a) *Identification*. *Treponema pallidum* nontreponemal test reagents are devices that consist of antigens derived from nontreponemal sources (sources not directly associated with treponemal organisms) and control sera (standardized sera with which test results are compared) used in serological tests to identify reagin, an antibody-like agent, which is produced from the reaction of treponema microorganisms with body tissues. The identification aids in the diagnosis of syphilis caused by microorganisms belonging to the genus *Treponema* and provides epidemiological information on syphilis.

(b) *Classification*. Class II (performance standards).

**§ 866.3830 *Treponema pallidum* treponemal test reagents.**

(a) *Identification*. *Treponema pallidum* treponemal test reagents are devices that consist of the antigens, antisera and all control reagents (standardized reagents with which test results are compared) which are derived from treponemal sources and that are used in the fluorescent treponemal antibody absorption test (FTA-ABS), the *Treponema pallidum* immobilization test (T.P.I.), and other treponemal tests used to identify antibodies to *Treponema pallidum* directly from infecting treponemal organisms in serum. The identification aids in the diagnosis of syphilis caused by bacteria belonging to the genus *Treponema* and provides epidemiological information on syphilis.

(b) *Classification*. Class II (performance standards).

**§ 866.3850 *Trichinella spiralis* serological reagents.**

(a) *Identification*. *Trichinella spiralis* serological reagents are devices that consist of antigens and antisera used in serological tests to identify antibodies to *Trichinella spiralis* in serum. The identification aids in the diagnosis of trichinosis caused by parasitic roundworms belonging to the genus *Trichinella* and provides epidemiological information on trichinosis. Trichinosis is caused by ingestion of undercooked, infested meat, especially pork, and characterized by fever, muscle weakness, and diarrhea.

(b) *Classification*. Class I (general controls). The device is exempt from the premarket notification procedures in subpart E of part 807 of this chapter subject to § 866.9.

[47 FR 50823, Nov. 9, 1982, as amended at 65 FR 2312, Jan. 14, 2000]

**§ 866.3860 *Trichomonas vaginalis* nucleic acid assay.**

(a) *Identification*. A *Trichomonas vaginalis* nucleic acid assay is a device that consists of primers, probes, enzymes, and controls for the amplification and detection of trichomonas nucleic acids in endocervical swabs, vaginal swabs, and female urine specimens, from women symptomatic for vaginitis, cervicitis, or urethritis and/or to aid in the diagnosis of trichomoniasis in asymptomatic women. The detection of trichomonas nucleic acids, in conjunction with other laboratory tests, aids in the clinical laboratory diagnosis of trichomoniasis caused by *Trichomonas vaginalis*.

(b) *Classification*. Class II (special controls). The special controls are set forth in FDA's guideline document entitled: "Class II Special Controls Guideline: Nucleic Acid Amplification Assays for the Detection of *Trichomonas vaginalis*;" Guideline for Industry and Food and Drug Administration Staff." See § 866.1(e) for information on obtaining this document.

[80 FR 46192, Aug. 4, 2015]

**§ 866.3870 *Trypanosoma* spp. serological reagents.**

(a) *Identification.* *Trypanosoma* spp. serological reagents are devices that consist of antigens and antisera used in serological tests to identify antibodies to *Trypanosoma* spp. in serum. The identification aids in the diagnosis of trypanosomiasis, a disease caused by parasitic protozoans belonging to the genus *Trypanosoma*. Trypanosomiasis in adults is a chronic disease characterized by fever, chills, headache, and vomiting. Central nervous system involvement produces typical sleeping sickness syndrome: physical exhaustion, inability to eat, tissue wasting, and eventual death. Chagas disease, an acute form of trypanosomiasis in children, most seriously affects the central nervous system and heart muscle.

(b) *Classification.* Class I (general controls).

**§ 866.3900 Varicella-zoster virus serological reagents.**

(a) *Identification.* Varicella-zoster virus serological reagents are devices that consist of antigens and antisera used in serological tests to identify antibodies to varicella-zoster in serum. The identification aids in the diagnosis of diseases caused by varicella-zoster viruses and provides epidemiological information on these diseases. Varicella (chicken pox) is a mild, highly infectious disease, chiefly of children. Zoster (shingles) is the recurrent form of the disease, occurring in adults who were previously infected with varicella-zoster viruses. Zoster is the response (characterized by a rash) of the partially immune host to a reactivation of varicella viruses present in latent form in the patient's body.

(b) *Classification.* Class II (performance standards).

**§ 866.3920 Assayed quality control material for clinical microbiology assays.**

(a) *Identification.* An assayed quality control material for clinical microbiology assays is a device indicated for use in a test system to estimate test precision or to detect systematic analytical deviations that may arise from reagent or analytical instrument variation. This type of device consists of

single or multiple microbiological analytes intended for use with either qualitative or quantitative assays.

(b) *Classification.* Class II (special controls). The special controls for this device are:

(1) Premarket notification submissions must include detailed device description documentation and information concerning the composition of the quality control material, including, as appropriate:

- (i) Analyte concentration;
- (ii) Expected values;
- (iii) Analyte source;
- (iv) Base matrix;
- (v) Added components;
- (vi) Safety and handling information;

and

(vii) Detailed instructions for use.

(2) Premarket notification submissions must include detailed documentation, including line data as well as detailed study protocols and a statistical analysis plan used to establish performance, including:

(i) Description of the process for value assignment and validation.

(ii) Description of the protocol(s) used to establish stability.

(iii) Line data establishing precision/reproducibility.

(iv) Where applicable, assessment of matrix effects and any significant differences between the quality control material and typical patient samples in terms of conditions known to cause analytical error or affect assay performance.

(v) Where applicable, identify or define traceability or relationship to a domestic or international standard reference material and/or method.

(vi) Where applicable, detailed documentation related to studies for surrogate controls.

(3) Premarket notification submissions must include an adequate mitigation (e.g., real-time stability program) to the risk of false results due to potential modifications to the assays specified in the device's 21 CFR 809.10 compliant labeling.

(4) Your 21 CFR 809.10 compliant labeling must include the following:

(i) The intended use of your 21 CFR 809.10(a)(2) and (b)(2) compliant labeling must include the following:



(A) Assayed control material analyte(s);

(B) Whether the material is intended for quantitative or qualitative assays;

(C) Stating if the material is a surrogate control; and

(D) The system(s), instrument(s), or test(s) for which the quality control material is intended.

(ii) The intended use in your 21 CFR 809.10(a)(2) and (b)(2) compliant labeling must include the following statement: “This product is not intended to replace manufacturer controls provided with the device.”

(iii) A limiting statement that reads “Quality control materials should be used in accordance with local, state, federal regulations, and accreditation requirements.”

[82 FR 34850, July 27, 2017]

**§ 866.3930 *Vibrio cholerae* serological reagents.**

(a) *Identification.* *Vibrio cholerae* serological reagents are devices that are used in the agglutination (an antigen-antibody clumping reaction) test to identify *Vibrio cholerae* from cultured isolates derived from clinical specimens. The identification aids in the diagnosis of cholera caused by the bacterium *Vibrio cholerae* and provides epidemiological information on cholera. Cholera is an acute infectious disease characterized by severe diarrhea with extreme fluid and electrolyte (salts) depletion, and by vomiting, muscle cramps, and prostration. If untreated, the severe dehydration may lead to shock, renal failure, cardiovascular collapse, and death.

(b) *Classification.* Class II (special controls). The device is exempt from the premarket notification procedures in subpart E of part 807 of this chapter subject to § 866.9.

[47 FR 50823, Nov. 9, 1982, as amended at 63 FR 59227, Nov. 3, 1998]

**§ 866.3940 West Nile virus serological reagents.**

(a) *Identification.* West Nile virus serological reagents are devices that consist of antigens and antisera for the detection of anti-West Nile virus IgM antibodies, in human serum, from individuals who have signs and symptoms

consistent with viral meningitis/encephalitis. The detection aids in the clinical laboratory diagnosis of viral meningitis/encephalitis caused by West Nile virus.

(b) *Classification.* Class II (special controls). The special control is FDA’s guidance entitled “Class II Special Controls Guidance Document: Serological Reagents for the Laboratory Diagnosis of West Nile Virus.” See § 866.1(e) for the availability of this guidance document.

[68 FR 61745, Oct. 30, 2003]

**§ 866.3945 Dengue virus serological reagents.**

(a) *Identification.* Dengue virus serological reagents are devices that consist of antigens and antibodies for the detection of dengue virus and dengue antibodies in individuals who have signs and symptoms of dengue fever or dengue hemorrhagic fever. The detection aids in the clinical laboratory diagnosis of dengue fever or dengue hemorrhagic fever caused by dengue virus.

(b) *Classification.* Class II (special controls). The special control is FDA’s guideline entitled “Class II Special Controls Guideline: Dengue Virus Serological Reagents.” For availability of the guideline document, see § 866.1(e).

[79 FR 31023, May 30, 2014]

**§ 866.3946 Dengue virus nucleic acid amplification test reagents.**

(a) *Identification.* Dengue virus nucleic acid amplification test reagents are devices that consist of primers, probes, enzymes, and controls for the amplification and detection of dengue virus serotypes 1, 2, 3, or 4 from viral ribonucleic acid (RNA) in human serum and plasma from individuals who have signs and symptoms consistent with dengue (mild or severe). The identification of dengue virus serotypes 1, 2, 3, or 4 in human serum and plasma (sodium citrate) collected from human patients with dengue provides epidemiologic information for surveillance of circulating dengue viruses.

(b) *Classification.* Class II (special controls). The special control is FDA’s guideline entitled “Class II Special

**§ 866.3950**

**21 CFR Ch. I (4–1–20 Edition)**

Controls Guideline: Dengue Virus Nucleic Acid Amplification Test Reagents.” For availability of the guideline document, see § 866.1(e).

[79 FR 53609, Sept. 10, 2014]

**§ 866.3950 In vitro human immunodeficiency virus (HIV) drug resistance genotype assay.**

(a) *Identification.* The in vitro HIV drug resistance genotype assay is a device that consists of nucleic acid reagent primers and probes together with software for predicting drug resistance/susceptibility based on results obtained with these primers and probes. It is intended for use in detecting HIV genomic mutations that confer resistance to specific antiretroviral drugs, as an aid in monitoring and treating HIV infection.

(b) *Classification.* Class II (special controls). The special control for this device is FDA’s guidance document entitled “Class II Special Controls Guidance Document: In Vitro HIV Drug Resistance Genotype Assay.” See § 866.1(e) for the availability of this guidance document.

[72 FR 44382, Aug. 8, 2007]

**§ 866.3955 Human immunodeficiency virus (HIV) drug resistance genotyping assay using next generation sequencing technology.**

(a) *Identification.* The HIV drug resistance genotyping assay using next generation sequencing (NGS) technology is a prescription in vitro diagnostic device intended for use in detecting HIV genomic mutations that confer resistance to specific antiretroviral drugs. The device is intended to be used as an aid in monitoring and treating HIV infection.

(b) *Classification.* Class II (special controls). The special controls for this device are:

(1) The intended use of the device must:

(i) Specify the analyte (RNA or DNA), the genes in which mutations are detected, the clinical indications appropriate for test use, the sample type, and the specific population(s) for which the device is intended.

(ii) State that the device is not intended for use as an aid in the diagnosis of infection with HIV or to con-

firm the presence of HIV infection, or for screening donors of blood, plasma, or human cells, tissues, and cellular and tissue-based products.

(2) The labeling must include:

(i) A detailed device description, including but not limited to, all procedures from collection of the patient sample to reporting the final result, all device components, the control elements incorporated into the test procedure, instrument requirements, and reagents required for use but not provided as part of the device.

(ii) Performance characteristics from analytical studies and all intended specimen types.

(iii) A list of specific mutations detected.

(iv) The name and version of the standardized database used for sequence comparison and results derivation.

(v) A detailed explanation of the interpretation of test results, including acceptance criteria for evaluating the validity of a test run.

(vi) A limitation statement that the device is intended to be used in conjunction with clinical history and other laboratory findings. Results of this test are intended to be interpreted by a physician or equivalent.

(vii) A limitation statement that lack of detection of drug resistance mutations does not preclude the possibility of genetic mutation.

(viii) A limitation statement indicating the relevant genetic mutations that are included in the standardized database of HIV genomic sequences used for comparison and results derivation but that are not detected by the test.

(ix) A limitation statement that detection of a genomic drug resistance mutation may not correlate with phenotypic gene expression.

(x) A limitation statement that the test does not detect all genetic mutations associated with antiviral drugs.

(xi) A limitation statement listing the HIV types for which the test is not intended, if any.

(3) Device verification and validation must include:

(i) Design of primer sequences and rationale for sequence selection.

(ii) Computational path from collected raw data to reported result.

(iii) Detailed documentation of analytical studies including, but not limited to, characterization of the cutoff, analytical sensitivity, inclusivity, reproducibility, interference, cross reactivity, instrument and method carry-over/cross contamination, sample stability, and handling for all genomic mutations claimed in the intended use.

(iv) Precision studies that include all genomic mutations claimed in the intended use.

(v) Detailed documentation of a multisite clinical study evaluating the sensitivity and specificity of the device. Clinical study subjects must represent the intended use population and device results for all targets claimed in the intended use must be compared to Sanger sequencing or other methods found acceptable by FDA. Drug resistance-associated mutations at or above the 20 percent frequency level must detect the mutations in greater than 90 percent of at least 10 replicates, for each of drug class evaluated.

(vi) Documentation that variant calling is performed at a level of coverage that supports positive detection of all genomic mutations claimed in the intended use.

(vii) Detailed documentation of limit of detection (LoD) studies in which device performance is evaluated by testing a minimum of 100 HIV-positive clinical samples including samples with analyte concentrations near the clinical decision points and near the LoD.

(A) The LoD for the device must be determined using a minimum of 10 HIV-1 group M genotypes if applicable. A detection rate at  $1 \times$  LoD greater than or equal to 95 percent must be demonstrated for mutations with a frequency greater than 20 percent.

(B) The LoD of genetic mutations at frequency levels less than 20 percent must be established.

(viii) A predefined HIV genotyping bioinformatics analysis pipeline (BAP). The BAP must adequately describe the bioinformatic analysis of the sequencing data, including but not limited to read alignment, variant calling, assembly, genotyping, quality control, and final result reporting.

(ix) A clear description of the selection and use of the standardized database that is used for sequence comparison and results derivation.

(4) Premarket notification submissions must include the information in paragraphs (b)(3)(i) through (ix) of this section.

[85 FR 7217, Feb. 7, 2020]

**§ 866.3960 Nucleic acid-based device for the amplification, detection, and identification of microbial pathogens directly from whole blood specimens.**

(a) *Identification.* A nucleic acid-based device for the amplification, detection, and identification of microbial pathogens directly from whole blood specimens is a qualitative in vitro device intended for the amplification, detection, and identification of microbial-associated nucleic acid sequences from patients with suspected bloodstream infections. This device is intended to aid in the diagnosis of bloodstream infection when used in conjunction with clinical signs and symptoms and other laboratory findings.

(b) *Classification.* Class II (special controls). The special controls for this device are:

(1) Premarket notification submissions must include detailed device description documentation, including the device components, ancillary reagents required but not provided, and a detailed explanation of the methodology, including primer/probe sequence, design, and rationale for sequence selection.

(2) Premarket notification submissions must include detailed documentation from the following analytical and clinical performance studies: Analytical sensitivity (limit of detection), reactivity, inclusivity, precision, reproducibility, interference, cross reactivity, carryover, and cross contamination.

(3) Premarket notification submissions must include detailed documentation from a clinical study. The study, performed on a study population consistent with the intended use population, must compare the device performance to results obtained from well-accepted reference methods.

(4) Premarket notification submissions must include detailed documentation for device software, including, but not limited to, software applications and hardware-based devices that incorporate software.

(5) The device labeling must include limitations regarding the need for culture confirmation of negative specimens, as appropriate.

(6) A detailed explanation of the interpretation of results and acceptance criteria must be included in the device's 21 CFR 809.10(b)(9) compliant labeling.

(7) Premarket notification submissions must include details on an end user device training program that will be offered while marketing the device, as appropriate.

(8) As part of the risk management activities performed as part of your 21 CFR 820.30 design controls, you must document an appropriate end user device training program that will be offered as part of your efforts to mitigate the risk of failure to correctly operate the instrument.

[82 FR 47967, Oct. 16, 2017]

**§ 866.3970 Device to detect and identify microbial pathogen nucleic acids in cerebrospinal fluid.**

(a) *Identification.* A device to detect and identify microbial pathogen nucleic acids in cerebrospinal fluid is a qualitative in vitro device intended for the detection and identification of microbial-associated nucleic acid sequences from patients suspected of meningitis or encephalitis. A device to detect and identify microbial pathogen nucleic acids in cerebrospinal fluid is intended to aid in the diagnosis of meningitis or encephalitis when used in conjunction with clinical signs and symptoms and other clinical and laboratory findings.

(b) *Classification.* Class II (special controls). The special controls for this device are:

(1) Premarket notification submissions must include detailed device description documentation, including the device components, ancillary reagents required but not provided, and a detailed explanation of the methodology, including primer/probe sequence, de-

sign, and rationale for sequence selection.

(2) Premarket notification submissions must include detailed documentation from the following analytical studies: Analytical sensitivity (limit of detection), inclusivity, reproducibility, interference, cross reactivity, and specimen stability.

(3) Premarket notification submissions must include detailed documentation from a clinical study. The study, performed on a study population consistent with the intended use population, must compare the device performance to results obtained from well-accepted comparator methods.

(4) Premarket notification submissions must include detailed documentation for device software, including, but not limited to, software applications and hardware-based devices that incorporate software.

(5) The Intended Use statement in the device labeling must include a statement that the device is intended to be used in conjunction with standard of care culture.

(6) A detailed explanation of the interpretation of results and acceptance criteria must be included in the device's 21 CFR 809.10(b)(9) compliant labeling.

(7) The device labeling must include a limitation stating that the negative results do not preclude the possibility of central nervous system infection.

(8) The device labeling must include a limitation stating that device results are not intended to be used as the sole basis for diagnosis, treatment, or other patient management decisions.

(9) The device labeling must include a limitation stating that positive results do not mean that the organism detected is infectious or is the causative agent for clinical symptoms.

(10) As part of the risk management activities performed as part of your 21 CFR 820.30 design controls, you must document an appropriate end user device training program that will be offered as part of your efforts to mitigate the risk of failure to correctly operate the instrument.

[82 FR 48763, Oct. 20, 2017]

**§ 866.3980 Respiratory viral panel multiplex nucleic acid assay.**

(a) *Identification.* A respiratory viral panel multiplex nucleic acid assay is a qualitative in vitro diagnostic device intended to simultaneously detect and identify multiple viral nucleic acids extracted from human respiratory specimens or viral culture. The detection and identification of a specific viral nucleic acid from individuals exhibiting signs and symptoms of respiratory infection aids in the diagnosis of respiratory viral infection when used in conjunction with other clinical and laboratory findings. The device is intended for detection and identification of a combination of the following viruses:

- (1) Influenza A and Influenza B;
- (2) Influenza A subtype H1 and Influenza A subtype H3;
- (3) Respiratory Syncytial Virus subtype A and Respiratory Syncytial Virus subtype B;
- (4) Parainfluenza 1, Parainfluenza 2, and Parainfluenza 3 virus;
- (5) Human Metapneumovirus;
- (6) Rhinovirus; and
- (7) Adenovirus.

(b) *Classification.* Class II (special controls). The special controls are:

(1) FDA's guidance document entitled "Class II Special Controls Guidance Document: Respiratory Viral Panel Multiplex Nucleic Acid Assay;"

(2) For a device that detects and identifies Human Metapneumovirus, FDA's guidance document entitled "Class II Special Controls Guidance Document: Testing for Human Metapneumovirus (hMPV) Using Nucleic Acid Assays;" and

(3) For a device that detects and differentiates Influenza A subtype H1 and subtype H3, FDA's guidance document entitled "Class II Special Controls Guidance Document: Testing for Detection and Differentiation of Influenza A Virus Subtypes Using Multiplex Nucleic Acid Assays." See § 866.1(e) for the availability of these guidance documents.

[74 FR 52133, Oct. 9, 2009]

**§ 866.3985 Device to detect and identify microorganisms and associated resistance marker nucleic acids directly in respiratory specimens.**

(a) *Identification.* A device to detect and identify microorganisms and associated resistance marker nucleic acids directly from respiratory specimens is an in vitro diagnostic device intended for the detection and identification of microorganisms and associated resistance markers in respiratory specimens collected from patients with signs or symptoms of respiratory infection. The device is intended to aid in the diagnosis of respiratory infection in conjunction with clinical signs and symptoms and other laboratory findings. These devices do not provide confirmation of antibiotic susceptibility since mechanisms of resistance may exist other than those detected by the device.

(b) *Classification.* Class II (special controls). The special controls for this device are:

(1) The intended use for the 21 CFR 809.10 labeling must include a detailed description of what the device detects, the type of results provided to the user, the clinical indications appropriate for test use, and the specific population(s) for which the device is intended.

(2) The 21 CFR 809.10(b) labeling must include:

(i) A detailed device description, including all device components, control elements incorporated into the test procedure, instrument requirements, ancillary reagents required but not provided, and a detailed explanation of the methodology, including all pre-analytical methods for processing of specimens.

(ii) Performance characteristics from analytical studies, including, but not limited to, limit of detection, inclusivity, reproducibility, cross reactivity, interfering substances, competitive inhibition, carryover/cross contamination, specimen stability, and linearity, as applicable.

(iii) A limiting statement that the device is intended to be used in conjunction with clinical history, signs and symptoms, and results of other diagnostic tests, including culture and antimicrobial susceptibility testing.

(iv) A detailed explanation of the interpretation of test results for clinical specimens and acceptance criteria for any quality control testing.

(v) A limiting statement that negative results for microorganisms do not preclude the possibility of infection, and should not be used as the sole basis for diagnosis, treatment, or other patient management decisions.

(vi) If applicable, a limiting statement that detected microorganisms may not be the cause of lower respiratory tract infection and may be indicative of colonizing or normal respiratory flora.

(vii) If applicable, a limiting statement that detection of resistance markers cannot be definitively linked to specific microorganisms and that the source of a detected resistance marker may be an organism not detected by the assay, including colonizing flora.

(viii) If applicable, a limiting statement that detection of antibiotic resistance markers may not correlate with phenotypic gene expression.

(3) The 21 CFR 809.10(b) labeling and any test report generated by the device must include a limiting statement that negative results for resistance markers do not indicate susceptibility of detected microorganisms.

(4) Design verification and validation must include:

(i) Performance characteristics from clinical studies that include prospective (sequential) samples and, if appropriate, additional characterized samples. The study must be performed on a study population consistent with the intended use population and compare the device performance to results obtained from an FDA accepted reference method and/or FDA accepted comparator method, as appropriate. Results from the clinical studies must include the clinical study protocol (including predefined statistical analysis plan, if applicable), clinical study report, and results of all statistical analyses.

(ii) A detailed device description including the following:

(A) Thorough description of the assay methodology including, but not limited to, primer/probe sequences, primer/

probe design, and rationale for target sequence selection, as applicable.

(B) Algorithm used to generate a final result from raw data (e.g., how raw signals are converted into a reported result).

(iii) A detailed description of device software, including, but not limited to, validation activities and outcomes.

(iv) As part of the risk management activities, an appropriate end user device training program must be offered as an effort to mitigate the risk of failure from user error.

[84 FR 9228, Mar. 14, 2019]

**§ 866.3990 Gastrointestinal microorganism multiplex nucleic acid-based assay.**

(a) *Identification.* A gastrointestinal microorganism multiplex nucleic acid-based assay is a qualitative *in vitro* diagnostic device intended to simultaneously detect and identify multiple gastrointestinal microbial nucleic acids extracted from human stool specimens. The device detects specific nucleic acid sequences for organism identification as well as for determining the presence of toxin genes. The detection and identification of a specific gastrointestinal microbial nucleic acid from individuals exhibiting signs and symptoms of gastrointestinal infection aids in the diagnosis of gastrointestinal infection when used in conjunction with clinical evaluation and other laboratory findings. A gastrointestinal microorganism multiplex nucleic acid-based assay also aids in the detection and identification of acute gastroenteritis in the context of outbreaks.

(b) *Classification.* Class II (special controls). The special controls are set forth in FDA's guideline document entitled: "Class II Special Controls Guideline: Gastrointestinal Microorganism Multiplex Nucleic Acid-Based Assays for Detection and Identification of Microorganisms and Toxin Genes from Human Stool Specimens." For availability of the guideline document, see § 866.1(e).

[80 FR 67314, Nov. 2, 2015]

### Subpart E—Immunology Laboratory Equipment and Reagents

#### § 866.4070 RNA Preanalytical Systems.

(a) *Identification.* RNA Preanalytical Systems are devices intended to collect, store, and transport patient specimens, and stabilize intracellular RNA from the specimens, for subsequent isolation and purification of the intracellular RNA for RT-PCR used in in vitro molecular diagnostic testing.

(b) *Classification.* Class II (special controls). The special control is FDA's guidance document entitled "Class II Special Controls Guidance Document: RNA Preanalytical Systems (RNA Collection, Stabilization and Purification System for RT-PCR Used in Molecular Diagnostic Testing)." See § 866.1(e) for the availability of this guidance document.

[70 FR 49863, Aug. 25, 2005]

#### § 866.4100 Complement reagent.

(a) *Identification.* A complement reagent is a device that consists of complement, a naturally occurring serum protein from any warm-blooded animal such as guinea pigs, that may be included as a component part of serological test kits used in the diagnosis of disease.

(b) *Classification.* Class I (general controls). The device is exempt from the premarket notification procedures in subpart E of part 807 of this chapter subject to the limitations in § 866.9.

[47 FR 50823, Nov. 9, 2001, as amended at 66 FR 38792, July 25, 2001]

#### § 866.4500 Immunoelectrophoresis equipment.

(a) *Identification.* Immunoelectrophoresis equipment for clinical use with its electrical power supply is a device used for separating protein molecules. Immunoelectrophoresis is a procedure in which a complex protein mixture is placed in an agar gel and the various proteins are separated on the basis of their relative mobilities under the influence of an electric current. The separated proteins are then permitted to diffuse through the agar toward a multispecific antiserum, allowing pre-

cipitation and visualization of the separate complexes.

(b) *Classification.* Class I (general controls). The device is exempt from the premarket notification procedures in subpart E of part 807 of this chapter subject to the limitations in § 866.9.

[47 FR 50823, Nov. 9, 1982, as amended at 54 FR 25047, June 12, 1989; 66 FR 38792, July 25, 2001]

#### § 866.4520 Immunofluorometer equipment.

(a) *Identification.* Immunofluorometer equipment for clinical use with its electrical power supply is a device used to measure the fluorescence of fluorochrome-labeled antigen-antibody complexes. The concentration of these complexes may be measured by means of reflected light. A beam of light is passed through a solution in which a fluorochrome has been selectively attached to serum protein antibody molecules in suspension. The amount of light emitted by the fluorochrome label is detected by a photodetector, which converts light energy into electrical energy. The amount of electrical energy registers on a readout system such as a digital voltmeter or a recording chart. This electrical readout is called the fluorescence value and is used to measure the concentration of antigen-antibody complexes.

(b) *Classification.* Class I (general controls). The device is exempt from the premarket notification procedures in subpart E of part 807 of this chapter subject to the limitations in § 866.9.

[47 FR 50823, Nov. 9, 1982, as amended at 54 FR 25047, June 12, 1989; 66 FR 38792, July 25, 2001]

#### § 866.4540 Immunonephelometer equipment.

(a) *Identification.* Immunonephelometer equipment for clinical use with its electrical power supply is a device that measures light scattering from antigen-antibody complexes. The concentration of these complexes may be measured by means of reflected light. A beam of light passed through a solution is scattered by the particles in suspension. The amount of light is detected by a photodetector, which converts light energy into electrical energy. The

**§ 866.4600**

amount of electrical energy registers on a readout system such as a digital voltmeter or a recording chart. This electrical readout is called the light-scattering value and is used to measure the concentration of antigen-antibody complexes. This generic type of device includes devices with various kinds of light sources, such as laser equipment.

(b) *Classification.* Class I (general controls). The device is exempt from the premarket notification procedures in subpart E of part 807 of this chapter subject to the limitations in § 866.9.

[47 FR 50823, Nov. 9, 1982, as amended at 54 FR 25047, June 12, 1989; 66 FR 38792, July 25, 2001]

**§ 866.4600 Ouchterlony agar plate.**

(a) *Identification.* An ouchterlony agar plate for clinical use is a device containing an agar gel used to examine antigen-antibody reactions. In immunodiffusion, antibodies and antigens migrate toward each other through gel which originally contained neither of these reagents. As the reagents come in contact with each other, they combine to form a precipitate that is trapped in the gel matrix and is immobilized.

(b) *Classification.* Class I (general controls). The device is exempt from the premarket notification procedures in subpart E of part 807 of this chapter subject to the limitations in § 866.9.

[47 FR 50823, Nov. 9, 1982, as amended at 54 FR 25047, June 12, 1989; 66 FR 38792, July 25, 2001]

**§ 866.4700 Automated fluorescence *in situ* hybridization (FISH) enumeration systems.**

(a) *Identification.* An automated FISH enumeration system is a device that consists of an automated scanning microscope, image analysis system, and customized software applications for FISH assays. This device is intended for *in vitro* diagnostic use with FISH assays as an aid in the detection, counting and classification of cells based on recognition of cellular color, size, and shape, and in the detection and enumeration of FISH signals in interphase nuclei of formalin-fixed, paraffin-embedded human tissue specimens.

**21 CFR Ch. I (4–1–20 Edition)**

(b) *Classification.* Class II (special controls). The special control is FDA's guidance document entitled "Class II Special Controls Guidance Document: Automated Fluorescence *in situ* Hybridization (FISH) Enumeration Systems." See § 866.1(e) for the availability of this guidance document.

[70 FR 14534, Mar. 23, 2005]

**§ 866.4750 Automated indirect immunofluorescence microscope and software-assisted system.**

(a) *Identification.* An automated indirect immunofluorescence microscope and software-assisted system is a device that acquires, analyzes, stores, and displays digital images of indirect immunofluorescent slides. It is intended to be used as an aid in the determination of antibody status in clinical samples. The device may include a fluorescence microscope with light source, a motorized microscope stage, dedicated instrument controls, a camera, a computer, a sample processor, or other hardware components. The software may include fluorescent signal acquisition and processing software, data storage and transferring mechanisms, or assay specific algorithms to suggest results. A trained operator must confirm results generated with the device.

(b) *Classification.* Class II (special controls). The special controls for this device are:

(1) The labeling for the device must reference legally marketed assays intended for use with the device.

(2) Premarket notification submissions must include the following information:

(i) A detailed description of the device that includes:

(A) A detailed description of instrumentation and equipment, and illustrations or photographs of non-standard equipment or methods, if applicable;

(B) Detailed documentation of the software, including, but not limited to, stand-alone software applications and hardware-based devices that incorporate software, if applicable;

(C) A detailed description of appropriate internal and external quality controls that are recommended or provided. The description must identify



those control elements that are incorporated into the recommended testing procedures;

(D) Detailed description and specifications for sample preparation, processing, and storage, if applicable;

(E) Methodology and protocols for detecting fluorescence and visualizing results; and

(F) Detailed specification of the criteria for test results interpretation and reporting.

(ii) Data demonstrating the performance characteristics of the device, which must include:

(A) A comparison study of the results obtained with the conventional manual method (*i.e.*, reference standard), the device, and the reading of the digital image without aid of the software, using the same set of patient samples for each. The study must use a legally marketed assay intended for use with the device. Patient samples must be from the assay-specific intended use population and differential diagnosis population. Samples must also cover the assay measuring range, if applicable;

(B) Device clinical performance established by comparing device results at multiple U.S. sites to the clinical diagnostic standard used in the United States, using patient samples from the assay-specific intended use population and the differential diagnosis population. For all samples, the diagnostic clinical criteria and the demographic information must be collected and provided. Clinical validation must be based on the determination of clinical sensitivity and clinical specificity using the test results (*e.g.*, antibody status based on fluorescence to include pattern and titer, if applicable) compared to the clinical diagnosis of the subject from whom the clinical sample was obtained. The data must be summarized in tabular format comparing the result generated by automated, manual, and digital only interpretation to the disease status;

(C) Device precision/reproducibility data generated from within-run, between-run, between-day, between-lot, between-operator, between-instruments, between-site, and total precision for multiple nonconsecutive days (as applicable) using multiple opera-

tors, multiple instruments and at multiple sites. A well-characterized panel of patient samples or pools from the associated assay specific intended use population must be used;

(D) Device linearity data generated from patient samples covering the assay measuring range, if applicable;

(E) Device analytical sensitivity data, including limit of blank, limit of detection, and limit of quantitation, if applicable;

(F) Device assay specific cutoff, if applicable;

(G) Device analytical specificity data, including interference by endogenous and exogenous substances, if applicable;

(H) Device instrument carryover data, if applicable;

(I) Device stability data including real-time stability under various storage times and temperatures, if applicable; and

(J) Information on traceability to a reference material and description of value assignment of calibrators and controls, if applicable.

(iii) Identification of risk mitigation elements used by the device, including description of all additional procedures, methods, and practices, incorporated into the directions for use that mitigate risks associated with testing.

(3) Your 21 CFR 809.10 compliant labeling must include:

(i) A warning statement that reads “The device is for use by a trained operator in a clinical laboratory setting”;

(ii) A warning statement that reads “All software-aided results must be confirmed by the trained operator”;

(iii) A warning statement that reads “This device is only for use with reagents that are indicated for use with the device”; and

(iv) A description of the protocol and performance studies performed in accordance with paragraph (b)(2)(ii) of this section and a summary of the results, if applicable.

[82 FR 52648, Nov. 14, 2017]

**§ 866.4800 Radial immunodiffusion plate.**

(a) *Identification.* A radial immunodiffusion plate for clinical use is a device that consists of a plastic plate to which agar gel containing

## § 866.4830

antiserum is added. In radial immunodiffusion, antigens migrate through gel which originally contains specific antibodies. As the reagents come in contact with each other, they combine to form a precipitate that is trapped in the gel matrix and immobilized.

(b) *Classification.* Class I (general controls). The device is exempt from the premarket notification procedures in subpart E of part 807 of this chapter subject to the limitations in § 866.9.

[47 FR 50823, Nov. 9, 1982, as amended at 66 FR 38792, July 25, 2001]

## § 866.4830 Rocket immunoelectrophoresis equipment.

(a) *Identification.* Rocket immunoelectrophoresis equipment for clinical use is a device used to perform a specific test on proteins by using a procedure called rocket immunoelectrophoresis. In this procedure, an electric current causes the protein in solution to migrate through agar gel containing specific antisera. The protein precipitates with the antisera in a rocket-shaped pattern, giving the name to the device. The height of the peak (or the area under the peak) is proportional to the concentration of the protein.

(b) *Classification.* Class I (general controls). The device is exempt from the premarket notification procedures in subpart E of part 807 of this chapter subject to the limitations in § 866.9.

[47 FR 50823, Nov. 9, 1982, as amended at 54 FR 25047, June 12, 1989; 66 FR 38792, July 25, 2001]

## § 866.4900 Support gel.

(a) *Identification.* A support gel for clinical use is a device that consists of an agar or agarose preparation that is used while measuring various kinds of, or parts of, protein molecules by various immunochemical techniques, such as immunoelectrophoresis, immunodiffusion, or chromatography.

(b) *Classification.* Class I (general controls). The device is exempt from the premarket notification procedures in

## 21 CFR Ch. I (4–1–20 Edition)

subpart E of part 807 of this chapter subject to the limitations in § 866.9.

[47 FR 50823, Nov. 9, 1982, as amended at 54 FR 25047, June 12, 1989; 66 FR 38792, July 25, 2001]

## Subpart F—Immunological Test Systems

### § 866.5040 Albumin immunological test system.

(a) *Identification.* An albumin immunological test system is a device that consists of the reagents used to measure by immunochemical techniques the albumin (a plasma protein) in serum and other body fluids. Measurement of albumin aids in the diagnosis of kidney and intestinal diseases.

(b) *Classification.* Class II (special controls). The device is exempt from the premarket notification procedures in subpart E of part 807 of this chapter subject to § 866.9.

[47 FR 50823, Nov. 9, 1982, as amended at 63 FR 59227, Nov. 3, 1998]

### § 866.5060 Prealbumin immunological test system.

(a) *Identification.* A prealbumin immunological test system is a device that consists of the reagents used to measure by immunochemical techniques the prealbumin (a plasma protein) in serum and other body fluids. Measurement of prealbumin levels in serum may aid in the assessment of the patient's nutritional status.

(b) *Classification.* Class I (general controls). The device is exempt from the premarket notification procedures in subpart E of part 807 of this chapter subject to § 866.9.

[47 FR 50823, Nov. 9, 1982, as amended at 65 FR 2312, Jan. 14, 2000]

### § 866.5065 Human allotypic marker immunological test system.

(a) *Identification.* A human allotypic marker immunological test system is a device that consists of the reagents used to identify by immunochemical techniques the inherited human protein allotypic markers (such as nGm, nA<sub>2</sub> m, and Km allotypes) in serum and other body fluids. The identification may be used while studying population genetics.

(b) *Classification.* Class I (general controls). The device is exempt from the premarket notification procedures in subpart E of part 807 of this chapter subject to § 866.9.

[47 FR 50823, Nov. 9, 1982, as amended at 65 FR 2312, Jan. 14, 2000]

**§ 866.5080 Alpha-1-antichymotrypsin immunological test system.**

(a) *Identification.* An *alpha*-1-antichymotrypsin immunological test system is a device that consists of the reagents used to measure by immunochemical techniques *alpha*-1-antichymotrypsin (a protein) in serum, other body fluids, and tissues. *Alpha*-1-antichymotrypsin helps protect tissues against proteolytic (protein-splitting) enzymes released during infection.

(b) *Classification.* Class II (performance standards).

**§ 866.5090 Antimitochondrial antibody immunological test system.**

(a) *Identification.* An antimitochondrial antibody immunological test system is a device that consists of the reagents used to measure by immunochemical techniques the antimitochondrial antibodies in human serum. The measurements aid in the diagnosis of diseases that produce a spectrum of autoantibodies (antibodies produced against the body's own tissue), such as primary biliary cirrhosis (degeneration of liver tissue) and chronic active hepatitis (inflammation of the liver).

(b) *Classification.* Class II (performance standards).

**§ 866.5100 Antinuclear antibody immunological test system.**

(a) *Identification.* An antinuclear antibody immunological test system is a device that consists of the reagents used to measure by immunochemical techniques the autoimmune antibodies in serum, other body fluids, and tissues that react with cellular nuclear constituents (molecules present in the nucleus of a cell, such as ribonucleic acid, deoxyribonucleic acid, or nuclear proteins). The measurements aid in the diagnosis of systemic lupus erythematosus (a multisystem autoimmune disease in which antibodies attack the victim's own tissues), hepa-

titis (a liver disease), rheumatoid arthritis, Sjögren's syndrome (arthritis with inflammation of the eye, eyelid, and salivary glands), and systemic sclerosis (chronic hardening and shrinking of many body tissues).

(b) *Classification.* Class II (performance standards).

**§ 866.5110 Antiparietal antibody immunological test system.**

(a) *Identification.* An antiparietal antibody immunological test system is a device that consists of the reagents used to measure by immunochemical techniques the specific antibody for gastric parietal cells in serum and other body fluids. Gastric parietal cells are those cells located in the stomach that produce a protein that enables vitamin B<sub>12</sub> to be absorbed by the body. The measurements aid in the diagnosis of vitamin B<sub>12</sub> deficiency (or pernicious anemia), atrophic gastritis (inflammation of the stomach), and autoimmune connective tissue diseases (diseases resulting when the body produces antibodies against its own tissues).

(b) *Classification.* Class II (performance standards).

**§ 866.5120 Antismooth muscle antibody immunological test system.**

(a) *Identification.* An antismooth muscle antibody immunological test system is a device that consists of the reagents used to measure by immunochemical techniques the antismooth muscle antibodies (antibodies to nonstriated, involuntary muscle) in serum. The measurements aid in the diagnosis of chronic hepatitis (inflammation of the liver) and autoimmune connective tissue diseases (diseases resulting from antibodies produced against the body's own tissues).

(b) *Classification.* Class II (performance standards).

**§ 866.5130 Alpha-1-antitrypsin immunological test system.**

(a) *Identification.* An *alpha*-1-antitrypsin immunological test system is a device that consists of the reagents used to measure by immunochemical techniques the *alpha*-1-antitrypsin (a plasma protein) in serum, other body fluids, and tissues. The measurements

**§ 866.5150**

aid in the diagnosis of several conditions including juvenile and adult cirrhosis of the liver. In addition, *alpha*-1-antitrypsin deficiency has been associated with pulmonary emphysema.

(b) *Classification*. Class II (performance standards).

**§ 866.5150 Bence-Jones proteins immunological test system.**

(a) *Identification*. A Bence-Jones proteins immunological test system is a device that consists of the reagents used to measure by immunochemical techniques the Bence-Jones proteins in urine and plasma. Immunoglobulin molecules normally consist of pairs of polypeptide chains (subunits) of unequal size (light chains and heavy chains) bound together by several disulfide bridges. In some cancerous conditions, there is a proliferation of one plasma cell (antibody-producing cell) with excess production of light chains of one specific kind (monoclonal light chains). These free homogeneous light chains not associated with an immunoglobulin molecule can be found in urine and plasma, and have been called Bence-Jones proteins. Measurement of Bence-Jones proteins and determination that they are monoclonal aid in the diagnosis of multiple myeloma (malignant proliferation of plasma cells), Waldenstrom's macroglobulinemia (increased production of large immunoglobulins by spleen and bone marrow cells), leukemia (cancer of the blood-forming organs), and lymphoma (cancer of the lymphoid tissue).

(b) *Classification*. Class II (performance standards).

**§ 866.5160 Beta-globulin immunological test system.**

(a) *Identification*. A *beta*-globulin immunological test system is a device that consists of reagents used to measure by immunochemical techniques *beta* globulins (serum protein) in serum and other body fluids. *Beta*-globulin proteins include *beta*-lipoprotein, transferrin, glycoproteins, and complement, and are rarely associated with specific pathologic disorders.

(b) *Classification*. Class I (general controls). The device is exempt from the premarket notification procedures in

**21 CFR Ch. I (4-1-20 Edition)**

subpart E of part 807 of this chapter subject to § 866.9.

[47 FR 50823, Nov. 9, 1982, as amended at 65 FR 2312, Jan. 14, 2000]

**§ 866.5170 Breast milk immunological test system.**

(a) *Identification*. A breast milk immunological test system is a device that consists of the reagents used to measure by immunochemical techniques the breast milk proteins.

(b) *Classification*. Class I (general controls). The device is exempt from the premarket notification procedures in subpart E of part 807 of this chapter subject to the limitations in § 866.9.

[47 FR 50823, Nov. 9, 1982, as amended at 59 FR 63007, Dec. 7, 1994; 66 FR 38793, July 25, 2001]

**§ 866.5180 Fecal calprotectin immunological test system.**

(a) *Identification*. A fecal calprotectin immunological test system is an *in vitro* diagnostic device that consists of reagents used to quantitatively measure, by immunochemical techniques, fecal calprotectin in human stool specimens. The device is intended for *in vitro* diagnostic use as an aid in the diagnosis of inflammatory bowel diseases (IBD), specifically Crohn's disease and ulcerative colitis, and as an aid in differentiation of IBD from irritable bowel syndrome.

(b) *Classification*. Class II (special controls). The special control for these devices is FDA's guidance document entitled "Class II Special Controls Guidance Document: Fecal Calprotectin Immunological Test Systems." For the availability of this guidance document, see § 866.1(e).

[71 FR 42598, July 27, 2006]

**§ 866.5200 Carbonic anhydrase B and C immunological test system.**

(a) *Identification*. A carbonic anhydrase B and C immunological test system is a device that consists of the reagents used to measure by immunochemical techniques specific carbonic anhydrase protein molecules in serum and other body fluids. Measurements of carbonic anhydrase B and C aid in the diagnosis of abnormal hemoglobin metabolism.

(b) *Classification*. Class I (general controls). The device is exempt from the premarket notification procedures in subpart E of part 807 of this chapter subject to § 866.9.

[47 FR 50823, Nov. 9, 1982, as amended at 65 FR 2312, Jan. 14, 2000]

**§ 866.5210 Ceruloplasmin immunological test system.**

(a) *Identification*. A ceruloplasmin immunological test system is a device that consists of the reagents used to measure by immunochemical techniques the ceruloplasmin (copper-transporting serum protein) in serum, other body fluids, or tissues. Measurements of ceruloplasmin aid in the diagnosis of copper metabolism disorders.

(b) *Classification*. Class II (special controls). The device is exempt from the premarket notification procedures in subpart E of part 807 of this chapter subject to the limitations in § 866.9.

[47 FR 50823, Nov. 9, 1982, as amended at 84 FR 71800, Dec. 30, 2019]

**§ 866.5220 Cohn fraction II immunological test system.**

(a) *Identification*. A Cohn fraction II immunological test system is a device that consists of the reagents that contain or are used to measure that fraction of plasma containing protein gamma globulins, predominantly of the IgG class. The device may be used as a coprecipitant in radioimmunoassay methods, as raw material for the purification of IgG subclasses, and to reduce nonspecific adsorption of plasma proteins in immunoassay techniques. Measurement of these proteins aids in the diagnosis of any disease concerned with abnormal levels of IgG gamma globulins such as agammaglobulinemia or multiple myeloma.

(b) *Classification*. Class I (general controls). The device is exempt from the premarket notification procedures in subpart E of part 807 of this chapter subject to the limitations in § 866.9.

[47 FR 50823, Nov. 9, 1982, as amended at 59 FR 63007, Dec. 7, 1994; 66 FR 38793, July 25, 2001]

**§ 866.5230 Colostrum immunological test system.**

(a) *Identification*. A colostrum immunological test system is a device that consists of the reagents used to measure by immunochemical techniques the specific proteins in colostrum. Colostrum is a substance excreted by the mammary glands during pregnancy and until production of breast milk begins 1 to 5 days after childbirth.

(b) *Classification*. Class I (general controls). The device is exempt from the premarket notification procedures in subpart E of part 807 of this chapter subject to the limitations in § 866.9.

[47 FR 50823, Nov. 9, 1982, as amended at 59 FR 63007, Dec. 7, 1994; 66 FR 38793, July 25, 2001]

**§ 866.5240 Complement components immunological test system.**

(a) *Identification*. A complement components immunological test system is a device that consists of the reagents used to measure by immunochemical techniques complement components C<sub>1q</sub>, C<sub>1r</sub>, C<sub>1s</sub>, C<sub>2</sub>, C<sub>3</sub>, C<sub>4</sub>, C<sub>5</sub>, C<sub>6</sub>, C<sub>7</sub>, C<sub>8</sub>, and C<sub>9</sub>, in serum, other body fluids, and tissues. Complement is a group of serum proteins which destroy infectious agents. Measurements of these proteins aids in the diagnosis of immunologic disorders, especially those associated with deficiencies of complement components.

(b) *Classification*. Class II (performance standards).

[47 FR 50823, Nov. 9, 1982, as amended at 53 FR 11253, Apr. 6, 1988]

**§ 866.5250 Complement C<sub>1</sub> inhibitor (inactivator) immunological test system.**

(a) *Identification*. A complement C<sub>1</sub> inhibitor (inactivator) immunological test system is a device that consists of the reagents used to measure by immunochemical techniques the complement C<sub>1</sub> inhibitor (a plasma protein) in serum. Complement C<sub>1</sub> inhibitor occurs normally in plasma and blocks the action of the C<sub>1</sub> component of complement (a group of serum proteins which destroy infectious agents). Measurement of complement C<sub>1</sub> inhibitor aids in the diagnosis of hereditary

**§ 866.5260**

angioneurotic edema (increased blood vessel permeability causing swelling of tissues) and a rare form of angioedema associated with lymphoma (lymph node cancer).

(b) *Classification.* Class II (performance standards).

**§ 866.5260 Complement C<sub>3b</sub> inactivator immunological test system.**

(a) *Identification.* A complement C<sub>3b</sub> inactivator immunological test system is a device that consists of the reagents used to measure by immunochemical techniques the complement C<sub>3b</sub> inactivator (a plasma protein) in serum. Complement is a group of serum proteins that destroy infectious agents. Measurement of complement C<sub>3b</sub> inactivator aids in the diagnosis of inherited antibody dysfunction.

(b) *Classification.* Class II (performance standards).

**§ 866.5270 C-reactive protein immunological test system.**

(a) *Identification.* A C-reactive protein immunological test system is a device that consists of the reagents used to measure by immunochemical techniques the C-reactive protein in serum and other body fluids. Measurement of C-reactive protein aids in evaluation of the amount of injury to body tissues.

(b) *Classification.* Class II (performance standards).

**§ 866.5320 Properdin factor B immunological test system.**

(a) *Identification.* A properdin factor B immunological test system is a device that consists of the reagents used to measure by immunochemical techniques properdin factor B in serum and other body fluids. The deposition of properdin factor B in body tissues or a corresponding depression in the amount of properdin factor B in serum and other body fluids is evidence of the involvement of the alternative to the classical pathway of activation of complement (a group of plasma proteins which cause the destruction of cells which are foreign to the body). Measurement of properdin factor B aids in the diagnosis of several kidney diseases, e.g., chronic glomerulonephritis (inflammation of the glomeruli of the kidney), lupus nephritis (kidney dis-

**21 CFR Ch. I (4-1-20 Edition)**

ease associated with a multisystem autoimmune disease, systemic lupus erythematosus), as well as several skin diseases, e.g., dermatitis herpetiformis (presence of vesicles on the skin that burn and itch), and pemphigus vulgaris (large vesicles on the skin). Other diseases in which the alternate pathway of complement activation has been implicated include rheumatoid arthritis, sickle cell anemia, and gram-negative bacteremia.

(b) *Classification.* Class II (special controls). The device is exempt from the premarket notification procedures in subpart E of part 807 of this chapter subject to § 866.9.

[47 FR 50823, Nov. 9, 1982, as amended at 63 FR 59227, Nov. 3, 1998]

**§ 866.5330 Factor XIII, A, S, immunological test system.**

(a) *Identification.* A factor XIII, A, S, immunological test system is a device that consists of the reagents used to measure by immunochemical techniques the factor XIII (a bloodclotting factor), in platelets (A) or serum (S). Measurements of factor XIII, A, S, aid in the diagnosis and treatment of certain bleeding disorders resulting from a deficiency of this factor.

(b) *Classification.* Class I (general controls). The device is exempt from the premarket notification procedures in subpart E of part 807 of this chapter subject to § 866.9. This exemption does not apply to factor deficiency tests classified under § 864.7290 of this chapter.

[47 FR 50823, Nov. 9, 1982, as amended at 65 FR 2312, Jan. 14, 2000]

**§ 866.5340 Ferritin immunological test system.**

(a) *Identification.* A ferritin immunological test system is a device that consists of the reagents used to measure by immunochemical techniques the ferritin (an iron-storing protein) in serum and other body fluids. Measurements of ferritin aid in the diagnosis of diseases affecting iron metabolism, such as hemochromatosis (iron overload) and iron deficiency anemia.

(b) *Classification.* Class II (performance standards).

**§ 866.5350 Fibrinopeptide A immunological test system.**

(a) *Identification.* A fibrinopeptide A immunological test system is a device that consists of the reagents used to measure by immunochemical techniques the fibrinopeptide A (a blood-clotting factor) in plasma and other body fluids. Measurement of fibrinopeptide A may aid in the diagnosis and treatment of certain blood-clotting disorders.

(b) *Classification.* Class II (performance standards).

**§ 866.5360 Cohn fraction IV immunological test system.**

(a) *Identification.* A Cohn fraction IV immunological test system is a device that consists of or measures that fraction of plasma proteins, predominantly *alpha*- and *beta*- globulins, used as a raw material for the production of pure *alpha*- or *beta*- globulins. Measurement of specific *alpha*- or *beta*- globulins aids in the diagnosis of many diseases, such as Wilson's disease (an inherited disease affecting the liver and brain), Tangier's disease (absence of *alpha*-1-lipoprotein), malnutrition, iron deficiency anemia, red blood cell disorders, and kidney disease.

(b) *Classification.* Class I (general controls). The device is exempt from the premarket notification procedures in subpart E of part 807 of this chapter subject to the limitations in § 866.9.

[47 FR 50823, Nov. 9, 1982; 47 FR 56846, Dec. 21, 1982, as amended at 59 FR 63007, Dec. 7, 1994; 66 FR 38793, July 25, 2001]

**§ 866.5370 Cohn fraction V immunological test system.**

(a) *Identification.* A Cohn fraction V immunological test system is a device that consists of or measures that fraction of plasma containing predominantly albumin (a plasma protein). This test aids in the diagnosis of diseases where albumin levels may be depressed, e.g., nephrosis (disease of the kidney), proteinuria (protein in the urine), gastroenteropathy (disease of the stomach and small intestine), rheumatoid arthritis, and viral hepatitis.

(b) *Classification.* Class I (general controls). The device is exempt from the premarket notification procedures in

subpart E of part 807 of this chapter subject to the limitations in § 866.9.

[47 FR 50823, Nov. 9, 1982, as amended at 59 FR 63007, Dec. 7, 1994; 66 FR 38793, July 25, 2001]

**§ 866.5380 Free secretory component immunological test system.**

(a) *Identification.* A free secretory component immunological test system is a device that consists of the reagents used to measure by immunochemical techniques free secretory component (normally a portion of the secretory IgA antibody molecule) in body fluids. Measurement of free secretory component (protein molecules) aids in the diagnosis or repetitive lung infections and other hypogammaglobulinemic conditions (low antibody levels).

(b) *Classification.* Class II (special controls). The device is exempt from the premarket notification procedures in subpart E of part 807 of this chapter subject to § 866.9.

[47 FR 50823, Nov. 9, 1982, as amended at 63 FR 59227, Nov. 3, 1998]

**§ 866.5400 Alpha-globulin immunological test system.**

(a) *Identification.* An *alpha*-globulin immunological test system is a device that consists of the reagents used to measure by immunochemical techniques the *alpha*-globulin (a serum protein) in serum and other body fluids. Measurement of *alpha*-globulin may aid in the diagnosis of inflammatory lesions, infections, severe burns, and a variety of other conditions.

(b) *Classification.* Class I (general controls). The device is exempt from the premarket notification procedures in subpart E of part 807 of this chapter subject to § 866.9.

[47 FR 50823, Nov. 9, 1982, as amended at 65 FR 2312, Jan. 14, 2000]

**§ 866.5420 Alpha-1-glycoproteins immunological test system.**

(a) *Identification.* An *alpha*-1-glycoproteins immunological test system is a device that consists of the reagents used to measure by immunochemical techniques *alpha*-1-glycoproteins (a group of plasma proteins found in the *alpha*-1 group when subjected to electrophoresis) in serum

§ 866.5425

and other body fluids. Measurement of specific *alpha*-1-glycoproteins may aid in the diagnosis of collagen (connective tissue) disorders, tuberculosis, infections, extensive malignancy, and diabetes.

(b) *Classification*. Class I (general controls). The device is exempt from the premarket notification procedures in subpart E of part 807 of this chapter subject to § 866.9.

[47 FR 50823, Nov. 9, 1982, as amended at 65 FR 2312, Jan. 14, 2000]

§ 866.5425 **Alpha-2-glycoproteins immunological test system.**

(a) *Identification*. An *alpha*-2-glycoproteins immunological test system is a device that consists of the reagents used to measure by immunochemical techniques the *alpha*-2-glycoproteins (a group of plasma proteins found in the *alpha*-2 group when subjected to electrophoresis) in serum and other body fluids. Measurement of *alpha*-2-glycoproteins aids in the diagnosis of some cancers and genetically inherited deficiencies of these plasma proteins.

(b) *Classification*. Class I (general controls). The device is exempt from the premarket notification procedures in subpart E of part 807 of this chapter subject to § 866.9.

[47 FR 50823, Nov. 9, 1982, as amended at 65 FR 2312, Jan. 14, 2000]

§ 866.5430 **Beta-2-glycoprotein I immunological test system.**

(a) *Identification*. A *beta*-2-glycoprotein I immunological test system is a device that consists of the reagents used to measure by immunochemical techniques the *beta*-2-glycoprotein I (a serum protein) in serum and other body fluids. Measurement of *beta*-2-glycoprotein I aids in the diagnosis of an inherited deficiency of this serum protein.

(b) *Classification*. Class I (general controls). The device is exempt from the premarket notification procedures in subpart E of part 807 of this chapter subject to § 866.9.

[47 FR 50823, Nov. 9, 1982, as amended at 65 FR 2312, Jan. 14, 2000]

21 CFR Ch. I (4-1-20 Edition)

§ 866.5440 **Beta-2-glycoprotein III immunological test system.**

(a) *Identification*. A *beta*-2-glycoprotein III immunological test system is a device that consists of the reagents used to measure by immunochemical techniques the *beta*-2-glycoprotein III (a serum protein) in serum and other body fluids. Measurement of *beta*-2-glycoprotein III aids in the diagnosis of an inherited deficiency of this serum protein and a variety of other conditions.

(b) *Classification*. Class I (general controls). The device is exempt from the premarket notification procedures in subpart E of part 807 of this chapter subject to § 866.9.

[47 FR 50823, Nov. 9, 1982, as amended at 65 FR 2312, Jan. 14, 2000]

§ 866.5460 **Haptoglobin immunological test system.**

(a) *Identification*. A haptoglobin immunological test system is a device that consists of the reagents used to measure by immunochemical techniques the haptoglobin (a protein that binds hemoglobin, the oxygen-carrying pigment in red blood cells) in serum. Measurement of haptoglobin may aid in the diagnosis of hemolytic diseases (diseases in which the red blood cells rupture and release hemoglobin) related to the formation of hemoglobin-haptoglobin complexes and certain kidney diseases.

(b) *Classification*. Class II (special controls). The device is exempt from the premarket notification procedures in subpart E of part 807 of this chapter subject to § 866.9.

[47 FR 50823, Nov. 9, 1982, as amended at 63 FR 59227, Nov. 3, 1998]

§ 866.5470 **Hemoglobin immunological test system.**

(a) *Identification*. A hemoglobin immunological test system is a device that consists of the reagents used to measure by immunochemical techniques the different types of free hemoglobin (the oxygen-carrying pigment in red blood cells) in blood, urine, plasma, or other body fluids. Measurements of free hemoglobin aid in the diagnosis of various hematologic disorders, such as sickle cell anemia, Fanconi's anemia (a



rare inherited disease), aplastic anemia (bone marrow does not produce enough blood cells), and leukemia (cancer of the blood-forming organs).

(b) *Classification.* Class II (special controls). The device is exempt from the premarket notification procedures in subpart E of part 807 of this chapter subject to the limitations in § 866.9.

[47 FR 50823, Nov. 9, 1982, as amended at 84 FR 71800, Dec. 30, 2019]

**§ 866.5490 Hemopexin immunological test system.**

(a) *Identification.* A hemopexin immunological test system is a device that consists of the reagents used to measure by immunochemical techniques the hemopexin (a serum protein that binds heme, a component of hemoglobin) in serum. Measurement of hemopexin aids in the diagnosis of various hematologic disorders, such as hemolytic anemia (anemia due to shortened in vivo survival of mature red blood cells and inability of the bone marrow to compensate for their decreased life span) and sickle cell anemia.

(b) *Classification.* Class II (special controls). The device is exempt from the premarket notification procedures in subpart E of part 807 of this chapter subject to § 866.9.

[47 FR 50823, Nov. 9, 1982, as amended at 63 FR 59227, Nov. 3, 1998]

**§ 866.5500 Hypersensitivity pneumonitis immunological test system.**

(a) *Identification.* A hypersensitivity pneumonitis immunological test system is a device that consists of the reagents used to measure by immunochemical techniques the immunoglobulin antibodies in serum which react specifically with organic dust derived from fungal or animal protein sources. When these antibodies react with such dusts in the lung, immune complexes precipitate and trigger an inflammatory reaction (hypersensitivity pneumonitis). Measurement of these immunoglobulin G antibodies aids in the diagnosis of hypersensitivity pneumonitis and other allergic respiratory disorders.

(b) *Classification.* Class II (performance standards).

**§ 866.5510 Immunoglobulins A, G, M, D, and E immunological test system.**

(a) *Identification.* An immunoglobulins A, G, M, D, and E immunological test system is a device that consists of the reagents used to measure by immunochemical techniques the immunoglobulins A, G, M, D, and E (serum antibodies) in serum. Measurement of these immunoglobulins aids in the diagnosis of abnormal protein metabolism and the body's lack of ability to resist infectious agents.

(b) *Classification.* Class II (performance standards).

**§ 866.5520 Immunoglobulin G (Fab fragment specific) immunological test system.**

(a) *Identification.* An immunoglobulin G (Fab fragment specific) immunological test system is a device that consists of the reagents used to measure by immunochemical techniques the Fab antigen-binding fragment resulting from breakdown of immunoglobulin G antibodies in urine, serum, and other body fluids. Measurement of Fab fragments of immunoglobulin G aids in the diagnosis of lymphoproliferative disorders, such as multiple myeloma (tumor of bone marrow cells), Waldenstrom's macroglobulinemia (increased immunoglobulin production by the spleen and bone marrow cells), and lymphoma (tumor of the lymphoid tissues).

(b) *Classification.* Class I (general controls). The device is exempt from the premarket notification procedures in subpart E of part 807 of this chapter subject to the limitations in § 866.9.

[47 FR 50823, Nov. 9, 1982, as amended at 61 FR 1119, Jan. 16, 1996; 66 FR 38793, July 25, 2001]

**§ 866.5530 Immunoglobulin G (Fc fragment specific) immunological test system.**

(a) *Identification.* An immunoglobulin G (Fc fragment specific) immunological test system is a device that consists of the reagents used to measure by immunochemical techniques the Fc (carbohydrate containing) fragment of immunoglobulin G (resulting from breakdown of

**§ 866.5540**

immunoglobulin G antibodies) in urine, serum, and other body fluids. Measurement of immunoglobulin G Fc fragments aids in the diagnosis of plasma cell antibody-forming abnormalities, e.g., gamma heavy chain disease.

(b) *Classification.* Class I (general controls). The device is exempt from the premarket notification procedures in subpart E of part 807 of this chapter subject to the limitations in § 866.9.

[47 FR 50823, Nov. 9, 1982, as amended at 61 FR 1119, Jan. 16, 1996; 66 FR 38793, July 25, 2001]

**§ 866.5540 Immunoglobulin G (Fd fragment specific) immunological test system.**

(a) *Identification.* An immunoglobulin G (Fd fragment specific) immunological test system is a device that consists of the reagents used to measure by immunochemical techniques the amino terminal (antigen-binding) end (Fd fragment) of the heavy chain (a subunit) of the immunoglobulin antibody molecule in serum. Measurement of immunoglobulin G Fd fragments aids in the diagnosis of plasma antibody-forming cell abnormalities.

(b) *Classification.* Class I (general controls). The device is exempt from the premarket notification procedures in subpart E of part 807 of this chapter subject to the limitations in § 866.9.

[47 FR 50823, Nov. 9, 1982, as amended at 59 FR 63007, Dec. 7, 1994; 66 FR 38793, July 25, 2001]

**§ 866.5550 Immunoglobulin (light chain specific) immunological test system.**

(a) *Identification.* An immunoglobulin (light chain specific) immunological test system is a device that consists of the reagents used to measure by immunochemical techniques both kappa and lambda types of light chain portions of immunoglobulin molecules in serum, other body fluids, and tissues. In some disease states, an excess of light chains are produced by the antibody-forming cells. These free light chains, unassociated with gamma globulin molecules, can be found in a patient's body fluids and tissues. Measurement of the various amounts of the different types of light chains aids in

**21 CFR Ch. I (4-1-20 Edition)**

the diagnosis of multiple myeloma (cancer of antibody-forming cells), lymphocytic neoplasms (cancer of lymphoid tissue), Waldenstrom's macroglobulinemia (increased production of large immunoglobulins), and connective tissue diseases such as rheumatoid arthritis or systemic lupus erythematosus.

(b) *Classification.* Class II (performance standards).

**§ 866.5560 Lactic dehydrogenase immunological test system.**

(a) *Identification.* A lactic dehydrogenase immunological test system is a device that consists of the reagents used to measure by immunochemical techniques the activity of the lactic dehydrogenase enzyme in serum. Increased levels of lactic dehydrogenase are found in a variety of conditions, including megaloblastic anemia (decrease in the number of mature red blood cells), myocardial infarction (heart disease), and some forms of leukemia (cancer of the blood-forming organs). However, the diagnostic usefulness of this device is limited because of the many conditions known to cause increased lactic dehydrogenase levels.

(b) *Classification.* Class I (general controls). The device is exempt from the premarket notification procedures in subpart E of part 807 of this chapter subject to § 866.9.

[47 FR 50823, Nov. 9, 1982, as amended at 65 FR 2312, Jan. 14, 2000]

**§ 866.5570 Lactoferrin immunological test system.**

(a) *Identification.* A lactoferrin immunological test system is a device that consists of the reagents used to measure by immunochemical techniques the lactoferrin (an iron-binding protein with the ability to inhibit the growth of bacteria) in serum, breast milk, other body fluids, and tissues. Measurement of lactoferrin may aid in the diagnosis of an inherited deficiency of this protein.

(b) *Classification.* Class I (general controls). The device is exempt from the premarket notification procedures in subpart E of part 807 of this chapter subject to § 866.9.

[47 FR 50823, Nov. 9, 1982, as amended at 65 FR 2312, Jan. 14, 2000]

**§ 866.5580 Alpha-1-lipoprotein immunological test system.**

(a) *Identification.* An *alpha-1*-lipoprotein immunological test system is a device that consists of the reagents used to measure by immunochemical techniques the *alpha-1*-lipoprotein (high-density lipoprotein) in serum and plasma. Measurement of *alpha-1*-lipoprotein may aid in the diagnosis of Tangier disease (a hereditary disorder of fat metabolism).

(b) *Classification.* Class II (performance standards).

**§ 866.5590 Lipoprotein X immunological test system.**

(a) *Identification.* A lipoprotein X immunological test system is a device that consists of the reagents used to measure by immunochemical techniques lipoprotein X (a high-density lipoprotein) in serum and other body fluids. Measurement of lipoprotein X aids in the diagnosis of obstructive liver disease.

(b) *Classification.* Class I (general controls). The device is exempt from the premarket notification procedures in subpart E of part 807 of this chapter subject to § 866.9.

[47 FR 50823, Nov. 9, 1982, as amended at 65 FR 2313, Jan. 14, 2000]

**§ 866.5600 Low-density lipoprotein immunological test system.**

(a) *Identification.* A low-density lipoprotein immunological test system is a device that consists of the reagents used to measure by immunochemical techniques the low-density lipoprotein in serum and other body fluids. Measurement of low-density lipoprotein in serum may aid in the diagnosis of disorders of lipid (fat) metabolism and help to identify young persons at risk from cardiovascular diseases.

(b) *Classification.* Class II (performance standards).

**§ 866.5620 Alpha-2-macroglobulin immunological test system.**

(a) *Identification.* An *alpha-2*-macroglobulin immunological test system is a device that consists of the reagents used to measure by immunochemical techniques the *alpha-2*-macroglobulin (a serum protein) in plasma. Measurement of *alpha-2*-

macroglobulin may aid in the diagnosis of blood-clotting or clot lysis disorders.

(b) *Classification.* Class II (special controls). The device is exempt from the premarket notification procedures in subpart E of part 807 of this chapter subject to the limitations in § 866.9.

[47 FR 50823, Nov. 9, 1982, as amended at 84 FR 71800, Dec. 30, 2019]

**§ 866.5630 Beta-2-microglobulin immunological test system.**

(a) *Identification.* A *beta-2*-microglobulin immunological test system is a device that consists of the reagents used to measure by immunochemical techniques *beta-2*-microglobulin (a protein molecule) in serum, urine, and other body fluids. Measurement of *beta-2*-microglobulin aids in the diagnosis of active rheumatoid arthritis and kidney disease.

(b) *Classification.* Class II (special controls). The device is exempt from the premarket notification procedures in subpart E of part 807 of this chapter subject to the limitations in § 866.9.

[47 FR 50823, Nov. 9, 1982, as amended at 84 FR 71800, Dec. 30, 2019]

**§ 866.5640 Infectious mononucleosis immunological test system.**

(a) *Identification.* An infectious mononucleosis immunological test system is a device that consists of the reagents used to measure by immunochemical techniques heterophile antibodies frequently associated with infectious mononucleosis in serum, plasma, and other body fluids. Measurements of these antibodies aid in the diagnosis of infectious mononucleosis.

(b) *Classification.* Class II (performance standards).

[47 FR 50823, Nov. 9, 1982; 47 FR 56846, Dec. 21, 1982]

**§ 866.5660 Multiple autoantibodies immunological test system.**

(a) *Identification.* A multiple autoantibodies immunological test system is a device that consists of the reagents used to measure by immunochemical techniques the autoantibodies (antibodies produced against the body's own tissues) in serum and other body fluids. Measurement of multiple autoantibodies aids

in the diagnosis of autoimmune disorders (disease produced when the body's own tissues are injured by autoantibodies).

(b) *Classification*. Class II (performance standards).

**§ 866.5665 Aquaporin-4 autoantibody immunological test system.**

(a) *Identification*. An Aquaporin-4 autoantibody immunological test system is a device that consists of reagents used to measure by immunochemical techniques autoantibodies in human serum samples that react with Aquaporin-4 (AQP4Ab). The measurements aid in the diagnosis of neuromyelitis optica (NMO) and neuromyelitis optica spectrum disorders (NMOSD) in conjunction with other clinical, laboratory, and radiological (*e.g.*, magnetic resonance imaging) findings.

(b) *Classification*. Class II (special controls). The special controls for this device are:

(1) Premarket notification submissions must include the following information:

(i) A detailed device description including:

(A) A detailed description of all components including all required ancillary reagents in the test;

(B) If applicable, a detailed description of instrumentation and equipment, including illustrations or photographs of non-standard equipment or manuals;

(C) If applicable, detailed documentation of the device software, including, but not limited to, standalone software applications and hardware-based devices that incorporate software;

(D) A detailed description of appropriate internal and external quality controls that are recommended or provided. The description must identify those control elements that are incorporated into the specified testing procedures;

(E) Detailed specifications for sample collection, processing, and storage;

(F) A detailed description of methodology and assay procedure;

(G) A description of how the assay cutoff (the medical decision point between positive and negative) was estab-

lished and validated as well as supporting data; and

(H) Detailed specification of the criteria for test results interpretation and reporting.

(ii) Detailed information demonstrating the performance characteristics of the device, including:

(A) Device precision/reproducibility data generated from within-run, between-run, between-day, between-lot, between-site, and total precision for multiple nonconsecutive days, as applicable. A well characterized panel of patient samples or pools from the indicated population that covers the device measuring range must be used.

(B) Device linearity data generated from samples covering the device measuring range, if applicable.

(C) Information on traceability to a reference material and description of value assignment of calibrators and controls, if applicable.

(D) Device analytical sensitivity data, including limit of blank, limit of detection, and limit of quantitation, if applicable.

(E) Device analytical specificity data, including interference by endogenous and exogenous substances, as well as cross-reactivity with samples derived from patients with other autoimmune diseases or conditions.

(F) Device instrument carryover data, when applicable.

(G) Device stability data, including real-time stability under various storage times and temperatures.

(H) Specimen stability data, including stability under various storage times, temperatures, freeze-thaw, and transport conditions, where appropriate.

(I) Method comparison data generated by comparison of the results obtained with the device to those obtained with a legally marketed predicate device with similar indications of use. A well-characterized panel of patient samples from the indicated population covering the device measuring range must be used.

(J) Specimen matrix comparison data, if more than one specimen type or anticoagulant can be tested with the device. Samples used for comparison

must be from well-characterized patient samples covering the device measuring range.

(K) Clinical performance must be established by comparing data generated by testing samples from the indicated population and the differential diagnosis or non-target disease groups with the device to the clinical diagnostic standard.

(1) The diagnosis of NMO and NMOSD must be based on clinical findings, laboratory tests (*e.g.*, serological tests), and radiological tests (*e.g.*, magnetic resonance imaging).

(2) The differential diagnosis or non-target disease group must include the applicable diseases or conditions, including but not be limited to the following: Multiple sclerosis, stroke, Lyme disease, shingles, syphilis, human immunodeficiency virus, hepatitis B, tuberculosis, Srgen's syndrome, systemic lupus erythematosus, systemic vasculitis, sarcoidosis, Graves' disease, Hashimoto's disease, Type I diabetes, rheumatoid arthritis, Addison's disease, and myasthenia gravis.

(3) Diagnosis of diseases or conditions for the differential or non-target disease groups must be based on established diagnostic criteria and clinical evaluation.

(4) For all samples, the diagnostic clinical criteria and the demographic information must be collected and provided.

(5) The clinical validation results must demonstrate clinical sensitivity and clinical specificity for the test values based on the presence or absence of NMO and NMOSD.

(6) The data must be summarized in tabular format comparing the interpretation of results to the disease status.

(L) Expected/reference values generated by testing an adequate number of samples from apparently healthy normal individuals.

(iii) Identification of risk mitigation elements used by the device, including description of all additional procedures, methods, and practices incorporated into the directions for use that mitigate risks associated with testing.

(2) The device's 21 CFR 809.10(b) compliant labeling must include warnings relevant to the device including:

(i) A warning statement that reads "The device is for use by laboratory professionals in a clinical laboratory setting"; and

(ii) A warning statement that reads "The device is not to be used as a stand-alone device but as an adjunct to other clinical information. A diagnosis of Neuromyelitis Optica (NMO) and Neuromyelitis Optica Spectrum Disorders (NMOSD) should not be made on a single test result. The clinical symptoms, results from physical examination, laboratory tests (*e.g.*, serological tests), and radiological tests (*e.g.* Magnetic Resonance Imaging), when appropriate, should always be taken into account when considering the diagnosis of NMO and NMOSD."

(3) The device's 21 CFR 809.10(b) compliant labeling must include a detailed description of the protocol and performance studies performed in accordance with paragraph (b)(1)(ii) of this section and a summary of the results.

[82 FR 50076, Oct. 30, 2017]

**§ 866.5670 Zinc transporter 8 autoantibody immunological test system.**

(a) *Identification.* A zinc transporter 8 autoantibody immunological test system is a device that consists of reagents used to measure, by immunochemical techniques, the autoantibodies in human serum samples that react with Zinc Transporter 8 (ZnT8). The measurements aid in the diagnosis of Type 1 diabetes mellitus (autoimmune mediated diabetes) in conjunction with other clinical and laboratory findings.

(b) *Classification.* Class II (special controls). The special controls for this device are:

(1) Premarket notification submissions must include the following information:

(i) A detailed description of the device that includes:

(A) A detailed description of all components in the test system, including a description of the assay components in the kit and all required ancillary reagents;

(B) A detailed description of instrumentation and equipment, and illustrations or photographs of non-standard equipment or methods if applicable;

(C) Detailed documentation of the device software, including, but not limited to, standalone software applications and hardware-based devices that incorporate software where applicable;

(D) A detailed description of appropriate internal and external quality controls that are recommended or provided. The description must identify those control elements that are incorporated into the recommended testing procedures;

(E) Detailed specifications for sample collection, processing, and storage;

(F) A detailed description of methodology and assay procedure; and

(G) Detailed specification of the criteria for test results interpretation and reporting.

(ii) Information that demonstrates the performance characteristics of the device, including:

(A) Device precision/reproducibility data generated from within-run, between-run, between-day, between-lot, between-operator, between-instruments, between-site, and total precision for multiple nonconsecutive days as applicable. A well characterized panel of patient samples or pools from the intended use population that covers the device measuring range must be used;

(B) Device linearity data generated from patient samples covering the assay measuring range if applicable;

(C) Information on traceability to a reference material and description of value assignment of calibrators and controls if applicable;

(D) Device analytical sensitivity data, including limit of blank, limit of detection and limit of quantitation if applicable;

(E) Device analytical specificity data, including interference by endogenous and exogenous substances, as well as cross-reactivity with samples derived from patients with other autoimmune diseases or conditions;

(F) Device instrument carryover data when applicable;

(G) Device stability data including real-time stability under various storage times and temperatures;

(H) Specimen stability data, including stability under various storage times, temperatures, freeze-thaw, and

transport conditions where appropriate;

(I) Method comparison data generated by comparison of the results obtained with the device to those obtained with a legally marketed predicate device with similar indication of use. Patient samples from the intended use population covering the device measuring range must be used;

(J) Specimen matrix comparison data if more than one specimen type or anticoagulant can be tested with the device. Samples used for comparison must be from patient samples covering the device measuring range;

(K) A description of how the assay cut-off (the medical decision point between positive and negative) was established and validated as well as supporting data;

(L) Clinical performance must be established by comparing data generated by testing samples from the intended use population and the differential diagnosis groups with the device to the clinical diagnostic standard. The diagnosis of Type 1 diabetes mellitus must be based on clinical history, physical examination, and laboratory tests, such as one or more pancreatic or insulin autoantibody test. Because the intended use population for Type 1 diabetes mellitus includes subjects less than 18 years old, samples from representative numbers of these subjects must be included. Representative numbers of samples from all age strata must also be included. The differential diagnosis groups must include, but not be limited to the following: Type 2 diabetes mellitus; metabolic syndrome; latent autoimmune diabetes in adults; other autoimmune diseases such as celiac disease (without a concomitant diagnosis of Type 1 diabetes mellitus), systemic lupus erythematosus, rheumatoid arthritis, and Hashimoto's thyroiditis; infection; renal disease; and testicular cancer. Diseases for the differential groups must be based on established diagnostic criteria and clinical evaluation. For all samples, the diagnostic clinical criteria and the demographic information must be collected and provided. The clinical validation results must demonstrate clinical sensitivity and clinical specificity for the

test values based on the presence or absence of Type 1 diabetes mellitus. The data must be summarized in tabular format comparing the interpretation of results to the disease status; and

(M) Expected/reference values generated by testing an adequate number of samples from apparently healthy normal individuals.

(iii) Identification of risk mitigation elements used by the device, including description of all additional procedures, methods, and practices incorporated into the directions for use that mitigate risks associated with testing.

(2) Your 21 CFR 809.10(a) compliant label and 21 CFR 809.10(b) compliant labeling must include warnings relevant to the assay including:

(i) A warning statement that reads, “The device is for use by laboratory professionals in a clinical laboratory setting”;

(ii) A warning statement that reads, “The test is not a stand-alone test but an adjunct to other clinical information. A diagnosis of Type 1 diabetes mellitus should not be made on a single test result. The clinical symptoms, results on physical examination, and laboratory tests (*e.g.*, serological tests), when appropriate, should always be taken into account when considering the diagnosis of Type 1 diabetes mellitus and Type 2 diabetes mellitus”;

(iii) A warning statement that reads, “Absence of Zinc T8 autoantibody does not rule out a diagnosis of Type 1 diabetes mellitus”; and

(iv) A warning statement that reads, “The assay has not been demonstrated to be effective for monitoring the stage of disease or its response to treatment.”

(3) Your 21 CFR 809.10(b) compliant labeling must include a description of the protocol and performance studies performed in accordance with paragraph (b)(1)(ii) of this section and a summary of the results.

[82 FR 49103, Oct. 20, 2017]

**§ 866.5680 Myoglobin immunological test system.**

(a) *Identification.* A myoglobin immunological test system is a device that consists of the reagents used to measure by immunochemical techniques the myoglobin (an oxygen stor-

age protein found in muscle) in serum and other body fluids. Measurement of myoglobin aids in the rapid diagnosis of heart or renal disease.

(b) *Classification.* Class II (performance standards).

**§ 866.5700 Whole human plasma or serum immunological test system.**

(a) *Identification.* A whole human plasma or serum immunological test system is a device that consists of reagents used to measure by immunochemical techniques the proteins in plasma or serum. Measurements of proteins in plasma or serum aid in the diagnosis of any disease concerned with abnormal levels of plasma or serum proteins, *e.g.*, agammaglobulinemia, allergies, multiple myeloma, rheumatoid vasculitis, or hereditary angioneurotic edema.

(b) *Classification.* Class I (general controls). The device is exempt from the premarket notification procedures in subpart E of part 807 of this chapter subject to the limitations in § 866.9.

[47 FR 50823, Nov. 9, 1982, as amended at 59 FR 63007, Dec. 7, 1994; 66 FR 38793, July 25, 2001]

**§ 866.5715 Plasminogen immunological test system.**

(a) *Identification.* A plasminogen immunological test system is a device that consists of the reagents used to measure by immunochemical techniques the plasminogen (an inactive substance from which plasmin, a blood-clotting factor, is formed) in serum, other body fluids, and tissues. Measurement of plasminogen levels may aid in the diagnosis of fibrinolytic (blood-clotting) disorders.

(b) *Classification.* Class I (general controls). The device is exempt from the premarket notification procedures in subpart E of part 807 of this chapter subject to § 866.9.

[47 FR 50823, Nov. 9, 1982, as amended at 65 FR 2313, Jan. 14, 2000]

**§ 866.5735 Prothrombin immunological test system.**

(a) *Identification.* A prothrombin immunological test system is a device that consists of the reagents used to measure by immunochemical techniques the prothrombin (clotting factor

II) in serum. Measurements of the amount of antigenically competent (ability to react with protein antibodies) prothrombin aid in the diagnosis of blood-clotting disorders.

(b) *Classification.* Class I (general controls). The device is exempt from the premarket notification procedures in subpart E of part 807 of this chapter subject to § 866.9. This exemption does not apply to multipurpose systems for in vitro coagulation studies classified under § 864.5425 of this chapter or prothrombin time tests classified under § 864.7750 of this chapter.

[47 FR 50823, Nov. 9, 1982, as amended at 65 FR 2313, Jan. 14, 2000]

**§ 866.5750 Radioallergosorbent (RAST) immunological test system.**

(a) *Identification.* A radioallergosorbent immunological test system is a device that consists of the reagents used to measure by immunochemical techniques the allergen antibodies (antibodies which cause an allergic reaction) specific for a given allergen. Measurement of specific allergen antibodies may aid in the diagnosis of asthma, allergies, and other pulmonary disorders.

(b) *Classification.* Class II (special controls). The device, when intended to detect any of the allergens included in Table 1 in this paragraph, is exempt from the premarket notification procedures in subpart E of part 807 of this chapter subject to the limitations in § 866.9.

TABLE 1—CLASS II EXEMPT ALLERGENS UNDER § 866.5750—RADIOALLERGIOSORBENT (RAST) IMMUNOLOGICAL TEST SYSTEMS

Allergen code	Allergen product	Source (taxonomical name)
<b>Grass Pollens</b>		
g1	Sweet vernal grass	<i>Anthoxanthum odoratum.</i>
g3	Cocksfoot grass, Orchard grass	<i>Dactylis glomerata.</i>
g4	Meadow fescue	<i>Festuca elatior.</i>
g5	Rye-grass (perennial rye grass)	<i>Lolium perenne.</i>
g7	Common reed (common reed grass)	<i>Phragmites communis.</i>
g8	Meadow grass, Kentucky blue (June grass)	<i>Poa pratensis.</i>
g9	Redtop, Bentgrass	<i>Agrostis stolonifera, Agrostis gigantea (Agrostis alba).</i>
g11	Brome grass	<i>Bromus inermis.</i>
g12	Cultivated rye (cultivated rye grass)	<i>Secale cereale.</i>
g13	Velvet grass	<i>Holcus lanatus.</i>
g14	Cultivated oat (cultivated oat grass)	<i>Avena sativa.</i>
g15	Cultivated wheat (cultivated wheat grass)	<i>Triticum aestivum (Triticum spp.).</i>
g16	Meadow foxtail (meadow foxtail grass)	<i>Alopecurus pratensis.</i>
g17	Bahia grass	<i>Paspalum notatum.</i>
g24	Wheat grass, Western	<i>Agropyron smithii (Elymus smithii).</i>
g30	Bluegrass, annual	<i>Poa annua.</i>
g70	Wild rye grass	<i>Elymus triticoides Elymus condensatus.</i>
g71	Canary grass	<i>Phalaris arundinacea.</i>
g201	Barley, cultivated	<i>Hordeum vulgare.</i>
g202	Maize, corn (cultivated corn)	<i>Zea mays.</i>
g203	Salt grass	<i>Distichlis spicata.</i>
g204	False oat-grass	<i>Arrhenatherum elatius.</i>
g216	Cyn d 1	<i>Cynodon dactylon.</i>
g701	Phl p 1.0102, Phl p 5.0101	<i>Phleum pratense.</i>
g702	Phl p 7.0101	<i>Phleum pratense.</i>
g703	Phl p 12.0101	<i>Phleum pratense.</i>
<b>Weed Pollens</b>		
w2	Western ragweed	<i>Ambrosia psilostachya.</i>
w4	False ragweed	<i>Ambrosia acanthicarpa (Franseria acanthicarpa).</i>
w5	Wormwood	<i>Artemisia absinthium Artemisia annua.</i>
w6	Mugwort	<i>Artemisia vulgaris.</i>
w7	Marguerite, ox-eye daisy	<i>Chrysanthemum leucanthemum.</i>
w8	Dandelion	<i>Taraxacum vulgare, Taraxacum officinale.</i>
w9	Plantain (English), Ribwort	<i>Plantago lanceolata.</i>
w10	Goosefoot, lamb's quarters	<i>Chenopodium album.</i>
w11	Saltwort (prickly), Russian thistle	<i>Salsola kali (Salsola pestifer).</i>
w12	Goldenrod	<i>Solidago virgaurea (Solidago spp.).</i>



TABLE 1—CLASS II EXEMPT ALLERGENS UNDER § 866.5750—RADIOALLERGOSORBENT (RAST) IMMUNOLOGICAL TEST SYSTEMS—Continued

Allergen code	Allergen product	Source (taxonomical name)
w13	Cocklebur, common	<i>Xanthium commune</i> .
w14	Common pigweed (rough pigweed)	<i>Amaranthus retroflexus</i> .
w15	Scale, Lenscale	<i>Atriplex lentiformis</i> .
w16	Rough marsh elder	<i>Iva ciliata, Iva annua</i> .
w17	Firebush (Kochia)	<i>Kochia scoparia</i> .
w18	Sheep sorrel	<i>Rumex acetosella</i> .
w19	Wall pellitory	<i>Parietaria officinalis</i> .
w20	Nettle (Common stinging nettle)	<i>Urtica dioica</i> .
w21	Wall pellitory	<i>Parietaria judaica</i> .
w22	Japanese hop (careless weed)	<i>Humulus japonicas (Humulus scandens)</i> .
w23	Yellow dock, Yellow dockweed	<i>Rumex crispus</i> .
w24	Spiny pigweed	<i>Amaranthus spinosus</i> .
w27	Carnation	<i>Dianthus spp.</i>
w28	Rose	<i>Rosa rugosa</i> .
w33	Clover	<i>Trifolium pratense</i> .
w35	Mexican tea	<i>Chenopodium ambrosioides</i> .
w36	Rabbit bush	<i>Ambrosia deltoidea (Franseria deltoidea)</i> .
w37	Salt bush, annual	<i>Atriplex wrightii</i> .
w39	Water hemp, Western	<i>Amaranthus rudis (Acnida tamariscina)</i> .
w41	Burrobrush	<i>Hymenoclea salsola</i> .
w42	Poverty weed	<i>Baccharis neglecta</i> .
w43	Common sagebrush	<i>Artemisia tridentata</i> .
w45	Alfalfa	<i>Medicago sativa</i> .
w46	Dog fennel	<i>Eupatorium capillifolium</i> .
w53	Geranium	<i>Geranium spp.</i>
w67	Groundsel bush	<i>Baccharis halimifolia</i> .
w69	Iodine bush	<i>Allenrolfea occidentalis</i> .
w70	Ragweed, slender	<i>Ambrosia confertiflora</i> .
w75	Wing scale (wingscale)	<i>Atriplex canescens</i> .
w82	Careless weed	<i>Amaranthus palmeri, Amaranthus hybridus</i> .
w90	Japanese hop	<i>Humulus japonicas (Humulus scandens)</i> .
w203	Rape (rape pollen)	<i>Brassica napus</i> .
w204	Sunflower	<i>Helianthus annuus</i> .
w206	Camomile	<i>Matricaria chamomilla</i> .
w207	Lupin	<i>Lupinus spp.</i>
w210	Sugar-beet	<i>Beta vulgaris</i> .
w211	Par j 2.0101	<i>Parietaria judaica</i> .
w231	Art v 1	<i>Artemisia vulgaris (Mugwort)</i> .
w232	Sal k 1	<i>Salsola kali</i> .
w233	Art v 3	<i>Artemisia vulgaris (LTP, Mugwort)</i> .
w234	Pla l 1	<i>Plantago lanceolata</i> .
w235	Che a 1.0101	<i>Chenopodium album</i> .
w236	Mer a 1.0101	<i>Mercurialis annua</i> .
a753	Art v 1	<i>Artemisia vulgaris (Mugwort weed)</i> .

**Tree Pollens**

t1	Box-elder (Maple)	<i>Acer negundo, Acer saccharum</i> .
t2	Gray alder, speckled alder (alder)	<i>Alnus incana</i> .
t4	Hazel, hazelnut	<i>Corylus avellana, Corylus americana</i> .
t5	American beech (beech)	<i>Fagus grandifolia (Fagus americana)</i> .
t6	Mountain juniper, Mountain cedar	<i>Juniperus ashei (Juniperus sabinoides)</i> .
t8	Elm	<i>Ulmus americana</i> .
t9	Olive	<i>Olea europaea</i> .
t10	Walnut	<i>Juglans californica, Juglans nigra</i> .
t11	Maple leaf sycamore, London plane, Plane tree	<i>Platanus acerifolia</i> .
t61	Sycamore	<i>Platanus occidentalis</i> .
t12	Willow	<i>Salix caprea, Salix nigra</i> .
t14	Cottonwood (Eastern Cottonwood/Black Cottonwood)	<i>Populus deltoides</i> .
t15	White ash	<i>Fraxinus americana</i> .
t16	White pine	<i>Pinus strobus</i> .
t18	Eucalyptus, gum-tree	<i>Eucalyptus globulus (Eucalyptus spp.)</i> .
t19/t26	Acacia	<i>Acacia longifolia (Acacia spp.)</i> .
t20	Mesquite	<i>Prosopis glandulosa/Prosopis juliflora</i> .
t21	Melaleuca, cajepout tree	<i>Melaleuca quinquenervia (Melaleuca leucadendron)</i> .
t22	Pecan, hickory	<i>Carya illinoensis (Carya pecan)</i> .
t23	Italian/Mediterranean/funeral cypress	<i>Cupressus sempervirens</i> .
t24	Japanese cypress	<i>Chamaecyparis obtusa (Chamaecyparis spp.)</i> .
t25	Ash	<i>Fraxinus excelsior</i> .
t27	Maple, red	<i>Acer rubrum</i> .

TABLE 1—CLASS II EXEMPT ALLERGENS UNDER § 866.5750—RADIOALLERGOSORBENT (RAST) IMMUNOLOGICAL TEST SYSTEMS—Continued

Allergen code	Allergen product	Source (taxonomical name)
t29	Acacia	<i>Acacia</i> spp.
t30	Birch, white	<i>Betula populifolia</i> .
t32	Willow, black	<i>Salix nigra</i> .
t33	Ash, Arizona	<i>Fraxinus velutina</i> .
t35	Cedar, salt	<i>Tamarix gallica</i> .
t37	Bald cypress (white bald cypress)	<i>Taxodium distichum</i> .
t38	Elm, Chinese/Siberian	<i>Ulmus pumila</i> .
t40	Hazelnut tree	<i>Corylus americana</i> .
t41	White hickory	<i>Carya alba</i> ( <i>Carya tomentosa</i> ).
t42	Oak, red	<i>Quercus rubra</i> .
t43	Loblolly pine	<i>Pinus taeda</i> .
t44	Hackberry	<i>Celtis occidentalis</i> .
t45	Cedar elm	<i>Ulmus crassifolia</i> .
t47	Juniper, one seed	<i>Juniperus monosperma</i> .
t48	Pine, lodgepole	<i>Pinus contorta</i> .
t49	Pine, ponderosa	<i>Pinus ponderosa</i> .
t50	Beech, European	<i>Fagus sylvatica</i> .
t51	Tree of Heaven	<i>Ailanthus altissima</i> .
t52	Western white pine	<i>Pinus monticola</i> .
t54	Russian olive	<i>Elaeagnus angustifolia</i> .
t55	Scotch broom	<i>Cytisus scoparius</i> .
t56	Bayberry	<i>Myrica cerifera</i> .
t57	Red cedar	<i>Juniperus virginiana</i> .
t60	Western juniper	<i>Juniperus occidentalis</i> .
t61	Sycamore	<i>Platanus occidentalis</i> .
t70	Mulberry (white mulberry)	<i>Morus alba</i> .
t71	Red mulberry	<i>Morus rubra</i> .
t72	Queen palm	<i>Arecastrum romanzoffianum</i> .
t73	Australian pine	<i>Casuarina equisetifolia</i> .
t77	Oak mix (red, white, black)	<i>Quercus</i> spp.
t80	Japanese cypress	<i>Chamaecyparis obtusa</i> .
t81	Japanese alder	<i>Alnus japonica</i> .
t83	Mango tree	<i>Mangifera indica</i> .
t90	Walnut, black	<i>Juglans nigra</i> .
t96	Poplar, white (poplar)	<i>Populus alba</i> .
t103/t218	Virginia live oak (live oak)	<i>Quercus virginiana</i> .
t105	Pepper tree	<i>Schinus molle</i> .
t110	Orange tree	<i>Citrus sinensis</i> .
t201	Spruce, Norway spruce	<i>Picea abies</i> ( <i>Picea excelsa</i> ).
t202	Alder, smooth	<i>Alnus incana</i> spp. <i>Rugosa</i> ( <i>Alnus rugosa</i> ).
t203	Horse chestnut	<i>Aesculus hippocastanum</i> .
t205	Elder	<i>Sambucus nigra</i> .
t206	Chestnut	<i>Castanea sativa</i> .
t207	Douglas fir	<i>Pseudotsuga menziesii</i> ( <i>Pseudotsuga taxifolia</i> ).
t208	Linden	<i>Tilia cordata</i> .
t209	Horn beam	<i>Carpinus betulus</i> .
t210	Privet	<i>Ligustrum vulgare</i> .
t211	Sweet gum	<i>Liquidambar styraciflua</i> .
t212	Cedar	<i>Libocedrus decurrens</i> .
t213	Pine	<i>Pinus radiata</i> .
t214	Date palm	<i>Phoenix canariensis</i> .
t215	Lilac	<i>Syringa vulgaris</i> .
t217	Pepper tree	<i>Schinus molle</i> .
t217	Red alder	<i>Alnus rubra</i> .
t218	Virginia live oak	<i>Quercus virginiana</i> .
t218	Bayberry (bayberry/sweet gale)	<i>Myrica gale</i> .
t219	Palo verde	<i>Cercidium floridum</i> .
t219	Red cedar	<i>Juniperus virginiana</i> .
t220	Bet v 4	<i>Betula verrucosa</i> (Birch).
t221	Bet v 2.0101, Bet v 4	<i>Betula verrucosa</i> (Birch).
t222	Cypress (Arizona cypress)	<i>Cupressus arizonica</i> .
t223	Oil palm	<i>Elaeis guineensis</i> .
t224	Ole e 1	<i>Olea europaea</i> .
t225	Bet v 6	<i>Betula verrucosa</i> (Birch).
t226	Cup a 1	<i>Cupressus arizonica</i> .
t227	Ole e 7	<i>Olea Europaea</i> .
t228	Aspen, quaking	<i>Populus tremuloides</i> .
t229	Eastern hemlock	<i>Tsuga canadensis</i> .
t230	Redwood (sequoia)	<i>Sequoia sempervirens</i> .
t232	Pussy willow	<i>Salix discolor</i> .

TABLE 1—CLASS II EXEMPT ALLERGENS UNDER § 866.5750—RADIOALLERGOSORBENT (RAST) IMMUNOLOGICAL TEST SYSTEMS—Continued

Allergen code	Allergen product	Source (taxonomical name)
t240	Ole e 9.0101	<i>Olea Europaea.</i>
t241	Pla a 1.0101	<i>Platanus acerifolia.</i>
t242	Pla a 2	<i>Platanus acerifolia.</i>
t243	Pla a 3.0101	<i>Platanus acerifolia.</i>
t244	Cor a 1.0103	<i>Corylus avellana.</i>
t245	Aln g 1.0101	<i>Ainus glutinosa.</i>
t246	Cry j 1	<i>Cryptomeria japonica.</i>
t280	Locust tree	<i>Robinia pseudoacacia.</i>
t401	Brazilian peppertree	<i>Schinus terebinthifolius.</i>
t402	Mastic tree	<i>Pistacia lentiscus.</i>
t404	Tree of heaven	<i>Ailanthus altissima.</i>
t406	Date palm	<i>Phoenix dactylifera.</i>
a482	Ole e 1	<i>Olea europaea</i> (Olive Oil).
<b>Mites</b>		
d207	Blo t 5.0101	<i>Blomia tropicalis.</i>
d208	Lep d 2.0101	<i>Lepidoglyphus destructor.</i>
<b>Microorganisms, Molds, Yeast</b>		
m1	<i>Penicillium chrysogenum</i> ( <i>Penicillium notatum</i> )	<i>Penicillium chrysogenum</i> ( <i>Penicillium notatum</i> ).
m2	<i>Cladosporium herbarum</i> ( <i>Hormodendrum</i> )	<i>Cladosporium herbarum</i> ( <i>Hormodendrum</i> ).
m3	<i>Aspergillus fumigatus</i>	<i>Aspergillus fumigatus.</i>
m4	<i>Mucor racemosus</i>	<i>Mucor racemosus.</i>
m5	<i>Candida albicans</i>	<i>Candida albicans.</i>
m7	<i>Botrytis cinerea</i>	<i>Botrytis cinerea.</i>
m8	<i>Drechslera halodes</i> ( <i>Setomelanomma rostrata</i> , <i>Helminthosporium halodes</i> , <i>Helminthosporium interseminatum</i> ).	<i>Drechslera halodes</i> ( <i>Setomelanomma rostrata</i> , <i>Helminthosporium halodes</i> ).
m9	<i>Fusarium moniliforme</i> ( <i>Fusarium proliferatum</i> )	<i>Fusarium moniliforme</i> ( <i>Fusarium proliferatum</i> ).
m10	<i>Stemphylium botryosum</i>	<i>Stemphylium herbarum</i> ( <i>Stemphylium botryosum</i> ).
m11	<i>Rhizopus nigricans</i>	<i>Rhizopus nigricans.</i>
m12	<i>Aureobasidium pullulans</i>	<i>Aureobasidium pullulans.</i>
m13	<i>Phoma betae</i>	<i>Phoma betae.</i>
m14	<i>Epicoccum purpurascens</i>	<i>Epicoccum purpurascens</i> ( <i>Epicoccum nigrum</i> ).
m15	<i>Trichoderma viride</i>	<i>Trichoderma viride.</i>
m16	<i>Curvularia lunata</i>	<i>Curvularia lunata</i> , <i>Curvularia specifera</i> (K923044).
m17	<i>Cladosporium fulvum</i>	<i>Cladosporium fulvum.</i>
m18	<i>Fusarium culmorum</i>	<i>Fusarium culmorum.</i>
m19	<i>Aspergillus versicolor</i>	<i>Aspergillus versicolor.</i>
m20	<i>Mucor mucedo</i>	<i>Mucor mucedo.</i>
m21	<i>Aspergillus clavatus</i>	<i>Aspergillus clavatus.</i>
m22	<i>Micropolyspora faeni</i>	<i>Saccharopolyspora rectivirgula</i> ( <i>Micropolyspora faeni</i> ).
m23	<i>Thermoactinomyces vulgaris</i>	<i>Thermoactinomyces vulgaris.</i>
m24	<i>Stachybotrys atra</i>	<i>Stachybotrys chartarum</i> ( <i>Stachybotrys atra</i> ).
m24	<i>Paecilomyces</i> spp	<i>Paecilomyces</i> spp.
m25	<i>Aspergillus versicolor</i>	<i>Aspergillus versicolor.</i>
m25	<i>Penicillium brevicompactum</i>	<i>Penicillium brevicompactum.</i>
m26	<i>Cladosporium cladosporioides</i>	<i>Cladosporium cladosporioides.</i>
m26	<i>Penicillium citrinum</i>	<i>Penicillium citrinum.</i>
m27	<i>Penicillium</i> spp	<i>Penicillium</i> spp.
m29	<i>Aspergillus repens</i>	<i>Aspergillus repens.</i>
m30	<i>Penicillium roqueforti</i>	<i>Penicillium roqueforti.</i>
m32	<i>Cladosporium cladosporioides</i>	<i>Cladosporium cladosporioides.</i>
m34	<i>Serpula lacrymans</i>	<i>Serpula lacrymans.</i>
m36	<i>Aspergillus terreus</i>	<i>Aspergillus terreus.</i>
m37	<i>Trichophyton mentagrophytes</i>	<i>Trichophyton mentagrophytes.</i>
m40	<i>Aspergillus amstelodami</i>	<i>Aspergillus amstelodami.</i>
m43	<i>Saccharomyces Carlsberg</i>	<i>Saccharomyces carlsbergensis.</i>
m44	<i>Saccharomyces cerevisiae</i>	<i>Saccharomyces cerevisiae.</i>
m45	<i>Hormodendrum hordei</i>	<i>Hormodendrum hordei.</i>
m46	<i>Bipolaris spicifera</i>	<i>Bipolaris spicifera.</i>
m47	<i>Aspergillus nidulans</i>	<i>Aspergillus nidulans.</i>
m48	<i>Aspergillus oryzae</i>	<i>Aspergillus oryzae.</i>
m49	<i>Fusarium oxysporum</i>	<i>Fusarium oxysporum.</i>
m50	<i>Micropolyspora faeni</i>	<i>Saccharopolyspora rectivirgula</i> ( <i>Micropolyspora faeni</i> ).
m51	<i>Thermoactinomyces vulgaris</i>	<i>Thermoactinomyces vulgaris.</i>

TABLE 1—CLASS II EXEMPT ALLERGENS UNDER § 866.5750—RADIOALLERGOSORBENT (RAST) IMMUNOLOGICAL TEST SYSTEMS—Continued

Allergen code	Allergen product	Source (taxonomical name)
m53	<i>Microspora canis</i>	<i>Microsporum canis</i> ( <i>Microspora canis</i> ).
m54	<i>Aspergillus flavus</i>	<i>Aspergillus flavus</i> .
m63	<i>Helminthosporium intersemin</i>	<i>Helminthosporium intersemin</i> .
m66	<i>Mucor plumbeus</i>	<i>Mucor plumbeus</i> .
m67	<i>Mycogone</i>	<i>Mycogone perniciosa</i> .
m68	<i>Nigrospora oryzae</i>	<i>Nigrospora oryzae</i> .
m69	<i>Rhodotorula</i>	<i>Rhodotorula rubra</i> ( <i>Rhodotorula mucilaginosa</i> ).
m70	<i>Malassezia furfur</i> ( <i>Pityrosporum orbiculare</i> )	<i>Malassezia furfur</i> ( <i>Pityrosporum orbiculare</i> ).
m71	<i>Spondylocladium</i>	<i>Spondylocladium</i> spp.
m72	<i>Epidermophyton</i>	<i>Epidermophyton floccosum</i> .
m73	<i>Epicoccum nigrum</i>	<i>Epicoccum purpurascens</i> ( <i>Epicoccum nigrum</i> ).
m80	<i>Staphylococcal enterotoxin A</i> ( <i>St a SEA</i> )	<i>Staphylococcus aureus</i> .
m80	<i>Helminthosporium</i> spp	<i>Helminthosporium</i> spp.
m81	<i>Staphylococcal enterotoxin B</i> ( <i>St a SEB</i> )	<i>Staphylococcus aureus</i> .
m88	<i>Stemphylium solani</i>	<i>Stemphylium solani</i> .
m93	<i>Gliocladium fimbriatum</i>	<i>Gliocladium fimbriatum</i> .
m94	<i>Phycomyces blakesleeanus</i>	<i>Phycomyces blakesleeanus</i> .
m201	<i>Tilletia tritici</i> ( <i>Ustilago nuda</i> , <i>Ustilago tritici</i> ) (Barley smut).	<i>Tilletia tritici</i> ( <i>Ustilago nuda</i> , <i>Ustilago tritici</i> ).
m202	<i>Acremonium kiliense</i> ( <i>Cephalosporium acremonium</i> )	<i>Acremonium kiliense</i> ( <i>Cephalosporium acremonium</i> ).
m203	<i>Trichosporon pullulans</i>	<i>Trichosporon pullulans</i> .
m204	<i>Ulocladium chartarum</i>	<i>Ulocladium chartarum</i> .
m205	<i>Trichophyton rubrum</i>	<i>Trichophyton rubrum</i> .
m207	<i>Aspergillus niger</i>	<i>Aspergillus niger</i> .
m208	<i>Chaetomium globosum</i>	<i>Chaetomium globosum</i> .
m209	<i>Penicillium frequentans</i>	<i>Penicillium glabrum</i> ( <i>Penicillium frequentans</i> ).
m209	<i>Stachybotrys chartarum</i>	<i>Stachybotrys chartarum</i> ( <i>Stachybotrys atra</i> ).
m210	<i>Trichophyton mentagrophytes</i> var. <i>goetzii</i>	<i>Trichophyton mentagrophytes</i> var. <i>goetzii</i> .
m211	<i>Trichophyton mentagrophytes</i> var. <i>interdigitale</i>	<i>Trichophyton mentagrophytes</i> var. <i>interdigitale</i> .
m211	Oat smut	<i>Ustilago avenae</i> .
m212	<i>Micropolyspora faeni</i>	<i>Saccharopolyspora rectivirgula</i> ( <i>Micropolyspora faeni</i> ).
m212	<i>Geotrichum candidum</i>	<i>Geotrichum candidum</i> .
m213	Bermuda grass smut	<i>Ustilago cynodontis</i> .
m214	Johnson grass smut	<i>Sphacelotheca cruenta</i> .
m215	Corn smut	<i>Ustilago maydis</i> .
m218	Asp f 1.0101	<i>Aspergillus fumigatus</i> .
a3050	Asp r 1	<i>Aspergillus restrictus</i> .
m219	Asp f 2	<i>Aspergillus fumigatus</i> .
m220	Asp f 3.0101	<i>Aspergillus fumigatus</i> .
m221	Asp f 4	<i>Aspergillus fumigatus</i> .
m222	Asp f 6.0101	<i>Aspergillus fumigatus</i> .
m223	<i>Staphylococcal enterotoxin C</i> ( <i>St a SEC</i> )	<i>Staphylococcus aureus</i> .
m224	<i>Staphylococcal enterotoxin D</i> ( <i>St a SED</i> )	<i>Staphylococcus aureus</i> .
m226	<i>Staphylococcal enterotoxin TSST</i> ( <i>St a TSST</i> )	<i>Staphylococcus aureus</i> .
m227	<i>Malassezia</i> spp. ( <i>Pityrosporum</i> spp.)	<i>Malassezia</i> spp. ( <i>Pityrosporum</i> spp.).
m228	<i>Aspergillus flavus</i> .	
m229	Alt a 1.0101	<i>Alternaria alternata</i> ( <i>Alternaria tenuis</i> ).
m230	Alt a 6.0101	<i>Alternaria alternata</i> ( <i>Alternaria tenuis</i> ).
m231	Cla h 8.0101	<i>Cladosporium herbarum</i> ( <i>Hormodendrum</i> ).
m300	<i>Eurotium</i> spp	<i>Eurotium</i> spp.
m304	<i>Aspergillus oryzae</i>	<i>Aspergillus oryzae</i> .
m305	<i>Penicillium brevicompactum</i>	<i>Penicillium brevicompactum</i> .
m309	<i>Aspergillus terreus</i>	<i>Aspergillus terreus</i> .
m310	<i>Aspergillus nidulans</i>	<i>Aspergillus nidulans</i> .
m311	<i>Aspergillus flavus</i>	<i>Aspergillus flavus</i> .
m312	<i>Aspergillus clavatus</i>	<i>Aspergillus clavatus</i> .
<b>Epidermal &amp; Animal</b>		
e6	Guinea pig epithelium	<i>Cavia porcellus</i> .
e7	Pigeon droppings	<i>Columba palumbus</i> , <i>Columba livia</i> .
e25	Chicken serum	<i>Gallus domesticus</i> ( <i>Gallus gallus domesticus</i> ; <i>Gallus</i> spp.).
e26	Parrot serum	<i>Psittacoidea</i> spp.
e62	Camel	<i>Camelus dromedaries</i> .
e70	Goose feathers	<i>Anser anser</i> .
e71	Mouse epithelium	<i>Mus musculus</i> ( <i>Mus</i> spp.).
e73	Rat epithelium	<i>Rattus norvegicus</i> .
e74	Rat urine proteins	<i>Rattus norvegicus</i> , <i>Rattus rattus</i> .

TABLE 1—CLASS II EXEMPT ALLERGENS UNDER § 866.5750—RADIOALLERGOSORBENT (RAST) IMMUNOLOGICAL TEST SYSTEMS—Continued

Allergen code	Allergen product	Source (taxonomical name)
e75	Rat serum proteins	<i>Rattus norvegicus</i> , <i>Rattus rattus</i> .
e76	Mouse serum proteins	<i>Mus musculus</i> ( <i>Mus</i> spp.).
e77	Budgerigar droppings	<i>Melopsittacus undulatus</i> .
e78	Budgerigar feathers	<i>Melopsittacus undulatus</i> .
e79	Budgerigar serum proteins	<i>Melopsittacus undulatus</i> .
e80	Goat epithelium	<i>Capra hircus</i> .
e81	Sheep epithelium	<i>Ovis aries</i> ( <i>Ovis</i> spp.).
e82	Rabbit epithelium	<i>Oryctolagus cuniculus</i> ( <i>Oryctolagus</i> spp.).
e83	Swine epithelium	<i>Sus scrofa</i> ( <i>Sus scrofa domesticus</i> ; <i>Sus</i> spp.).
e84	Hamster epithelium	<i>Cricetus cricetus</i> , <i>Mesocricetus auratus</i> , and <i>Phodopus sungorus</i> .
e85	Chicken feathers	<i>Gallus domesticus</i> ( <i>Gallus gallus domesticus</i> ; <i>Gallus</i> spp.).
e86	Duck feathers	<i>Anas platyrhynchos</i> .
e87	Rat epithelium, serum proteins, and urine proteins	<i>Rattus norvegicus</i> <i>Rattus rattus</i> .
e88	Mouse epithelium, serum proteins, and urine proteins (mouse).	<i>Mus musculus</i> ( <i>Mus</i> spp.).
e89	Turkey feathers	<i>Meleagris gallopavo</i> .
e90	Budgerigar serum proteins, feathers, and droppings	<i>Melopsittacus undulatus</i> .
e91	Pigeon serum proteins, feathers, and droppings	<i>Streptopelia roseogrisea</i> , <i>Psittacidae</i> spp.
e92	Parrot serum proteins, feathers, and droppings	<i>Ara</i> spp.
e93	Pigeon serum proteins	<i>Streptopelia roseogrisea</i> .
e94	Fel d 1.0101	<i>Felis domesticus</i> .
a345	Fel d 1	<i>Felis domesticus</i> .
e98	Parrot droppings	<i>Psittacoidea</i> spp.
e101	Can f 1.0101	<i>Canis familiaris</i> ( <i>Canis domesticus</i> ).
a174	Can f 1	<i>Canis familiaris</i> ( <i>Canis domesticus</i> ).
e102	Can f 2.0101	<i>Canis familiaris</i> ( <i>Canis domesticus</i> ).
e196	Parakeet feathers	<i>Nymphicus hollandicus</i> .
e197	Parakeet droppings	<i>Nymphicus hollandicus</i> .
e198	Parakeet serum	<i>Nymphicus hollandicus</i> .
e199	Canary bird serum	<i>Serinus canarius</i> .
e200	Canary bird droppings	<i>Serinus canarius</i> .
e201	Canary bird feathers (Canary feathers)	<i>Serinus canarius</i> .
e202	Reindeer epithelium	<i>Rangifer tarandus</i> .
e203	Mink epithelium	<i>Mustela</i> spp.
e204	Bos d 6	<i>Bos domesticus</i> ( <i>Bos taurus</i> ; <i>Bos</i> spp.).
e205	Horse, serum proteins	<i>Equus caballus</i> ( <i>Equus</i> spp.).
e206	Rabbit, serum proteins	<i>Oryctolagus cuniculus</i> ( <i>Oryctolagus</i> spp.).
e208	Chinchilla epithelium	<i>Chinchilla laniger</i> .
e209	Gerbil epithelium	<i>Meriones unguiculatus</i> .
e210	Fox epithelium	<i>Vulpes vulpes</i> .
e211	Rabbit, urine proteins	<i>Oryctolagus cuniculus</i> ( <i>Oryctolagus</i> spp.).
e212	Swine, urine proteins	<i>Sus scrofa</i> ( <i>Sus scrofa domesticus</i> ; <i>Sus</i> spp.).
e213	Parrot feathers	<i>Ara</i> spp.
e214	Finch feathers	<i>Lonchura domestica</i> .
e215	Pigeon feathers	<i>Streptopelia roseogrisea</i> ( <i>Streptopelia</i> spp.), <i>Columba</i> spp.
e216	Deer epithelium	<i>Dama dama</i> .
e217	Ferret epithelium	<i>Mustela putorius</i> .
e218	Chicken droppings	<i>Gallus domesticus</i> ( <i>Gallus gallus domesticus</i> ; <i>Gallus</i> spp.).
e219	Chicken, serum proteins	<i>Gallus domesticus</i> ( <i>Gallus gallus domesticus</i> ; <i>Gallus</i> spp.).
e220	Fel d 2, Cat serum albumin	<i>Felis domesticus</i> .
e221	Can f 3	<i>Canis familiaris</i> ( <i>Canis domesticus</i> ) ( <i>Dog serum albumin</i> ).
e222	Swine serum albumin ( <i>Sus s</i> PSA)	<i>Sus scrofa</i> ( <i>Sus scrofa domesticus</i> ; <i>Sus</i> spp.).
e225	Lovebird feathers	<i>Psittacoidea agapomis</i> .
e226	Can f 5.0101	<i>Canis familiaris</i> .
e227	Equ c 1.0101	<i>Equus caballus</i> .
e228	Fel d 4.0101	<i>Felis domesticus</i> .
e230	Equ c 3	<i>Equus caballus</i> .
e231	Mus m 1	<i>Mus musculus</i> .
<b>Food</b>		
f9	Rice	<i>Oryza sativa</i> .
f12	Pea (green pea)	<i>Pisum sativum</i> .
f15	White bean	<i>Phaseolus vulgaris</i> .

TABLE 1—CLASS II EXEMPT ALLERGENS UNDER § 866.5750—RADIOALLERGOSORBENT (RAST) IMMUNOLOGICAL TEST SYSTEMS—Continued

Allergen code	Allergen product	Source (taxonomical name)
f19	Cayenne pepper	<i>Capsicum frutescens</i> ( <i>Capsicum annuum</i> ).
f21	Sugar cane	<i>Saccharum officinarum</i> .
f22	Raspberry	<i>Rubus idaeus</i> .
f26	Pork	<i>Sus scrofa</i> ( <i>Sus scrofa domesticus</i> ; <i>Sus</i> spp.).
f29	Watermelon	<i>Citrullus lanatus</i> ( <i>Citrullus vulgaris</i> ).
f31	Carrot	<i>Daucus carota</i> .
f32	Oyster mushroom	<i>Pleurotus ostreatus</i> .
f33	Orange	<i>Citrus sinensis</i> .
f35	Potato	<i>Solanum tuberosum</i> .
f43	Mother's milk	<i>Homo sapiens</i> .
f44	Strawberry	<i>Fragaria vesca</i> ( <i>Fragaria</i> spp.).
f45	Yeast, baker's	<i>Saccharomyces cerevisiae</i> .
f46	Pepper, Red	<i>Capsicum annuum</i> .
f47	Garlic	<i>Allium sativum</i> .
f48	Onion	<i>Allium cepa</i> .
f49	Apple	<i>Malus x domestica</i> ( <i>Malus</i> spp.).
f51	Bamboo shoot	<i>Phyllostachys pubescens</i> .
f52	Cacao/chocolate	<i>Theobroma cacao</i> .
f54	Sweet potato	<i>Ipomoea batatas</i> .
f55	Common millet	<i>Panicum miliaceum</i> .
f56	Foxtail millet	<i>Setaria italica</i> .
f57	Japanese millet	<i>Echinochloa crus-galli</i> .
f58	Pacific squid	<i>Todarodes pacificus</i> .
f59	Octopus	<i>Octopus vulgaris</i> ( <i>Octopus</i> spp.).
f63	Kefir	NA.
f67	Parmesan cheese	NA.
f81	Cheese, cheddar type	NA.
f82	Cheese, mold type	NA.
f83	Chicken	<i>Gallus domesticus</i> ( <i>Gallus gallus domesticus</i> ; <i>Gallus</i> spp.).
f86	Parsley	<i>Petroselinum crispum</i> .
f87	Melon	<i>Cucumis melo Cucumis melo + Citrullus lanatus</i> .
f88	Mutton (lamb)	<i>Ovis aries</i> ( <i>Ovis</i> spp.).
f90	Malt	<i>Hordeum vulgare</i> .
f92	Banana	<i>Musa</i> spp.
f93	Cacao	<i>Theobroma cacao</i> .
f94	Pear	<i>Pyrus communis</i> ( <i>Pyrus</i> spp.).
f97	Yam	<i>Dioscorea</i> spp. <i>Dioscorea opposita</i> .
f97	Chamomile tea	<i>Matricaria chamomilla</i> .
f98	Gladiin	<i>Triticum aestivum</i> ( <i>Triticum</i> spp.).
f102	Cantaloupe	<i>Cucumis melo var. cantalupensis</i> .
f105	Chocolate	<i>Theobroma cacao</i> .
f109	Cottonseed	<i>Gossypium hirsutum</i> .
f110	Giant radish	<i>Raphanus sativus</i> .
f118	Zucchini	<i>Cucurbita pepo</i> .
f119	Radish	<i>Raphanus sativus</i> .
f120	Venison	<i>Capreolus capreolus</i> .
f121	Pinto bean	<i>Phaseolus vulgaris</i> .
f122	Cheese, American	NA.
f127	Black-eyed pea	<i>Vigna unguiculata</i> .
f131	Black Olive	<i>Olea europaea</i> .
f136	Red beet	<i>Beta vulgaris var. conditiva</i> .
f139	Goat's Cheese	<i>Capra aegagrus</i> .
f140	Bran	NA.
f141	Corn (vegetables)	<i>Zea mays</i> .
f152	Green bell pepper	<i>Capsicum annuum</i> .
f155	Brewer's yeast	<i>Saccharomyces carlsbergensis</i> .
f157	Duck	<i>Anas domesticus</i> .
f158	Goose	<i>Anser anser</i> .
f160	Camembert cheese	NA.
f162	Nectarine	<i>Prunus persica var. nucipersica</i> .
f163	Kohlrabi	<i>Brassica oleracea var. gongylodes</i> .
f65	Perch.	
f166	Leek	<i>Allium porrum</i> .
f170	Cheese (Switzerland) (Swiss cheese)	NA.
f174	Fig	<i>Ficus carica</i> .
f177	Cranberry	<i>Vaccinium macrocarpon</i> .
f179	Raisin	<i>Vitis</i> spp.
f182	Lima bean	<i>Phaseolus lunatus</i> .
f198	Flaxseed (bruised grain)	<i>Linum usitatissimum</i> .

TABLE 1—CLASS II EXEMPT ALLERGENS UNDER § 866.5750—RADIOALLERGIOSORBENT (RAST) IMMUNOLOGICAL TEST SYSTEMS—Continued

Allergen code	Allergen product	Source (taxonomical name)
f199	Untreated native milk	<i>Bos domesticus</i> ( <i>Bos taurus</i> ; <i>Bos</i> spp.).
f208	Lemon	<i>Citrus limon</i> .
f209	Grapefruit	<i>Citrus paradisi</i> .
f210	Pineapple	<i>Ananas comosus</i> .
f211	Blackberry	<i>Rubus fruticosus</i> .
f212	Mushroom (champignon)	<i>Agaricus hortensis</i> ( <i>Agaricus</i> spp.).
f213	Rabbit	<i>Oryctolagus cuniculus</i> ( <i>Oryctolagus</i> spp.).
f214	Spinach	<i>Spinacia oleracea</i> .
f215	Lettuce	<i>Lactuca sativa</i> .
f216	Cabbage	<i>Brassica oleracea</i> var. <i>capitata</i> .
f217	Brussels sprouts	<i>Brassica oleracea</i> var. <i>gem</i> .
f218	Paprika, sweet pepper	<i>Capsicum annuum</i> .
f219	Fennel seed	<i>Foeniculum vulgare</i> .
f219	Sage	<i>Salvia officinalis</i> .
f220	Cinnamon	<i>Cinnamomum</i> spp.
f221	Coffee	<i>Coffea</i> spp.
f222	Tea	<i>Camellia sinensis</i> .
f223	Green olive	<i>Olea europaea</i> .
f225	Summer squash, pumpkin	<i>Cucurbita pepo</i> .
f225	Pumpkin	<i>Cucurbita maxima</i> .
f226	Pumpkin seed	<i>Cucurbita pepo</i> .
f227	Sugar-beet seed	<i>Beta vulgaris</i> .
f229	Safflower Seed	<i>Carthamus tinctorius</i> .
f231	Milk, boiled	<i>Bos domesticus</i> ( <i>Bos taurus</i> ; <i>Bos</i> spp.).
f234	Vanilla	<i>Vanilla planifolia</i> .
f237	Apricot	<i>Prunus armeniaca</i> .
f241	Gouda cheese	NA.
f242	Cherry	<i>Prunus avium</i> .
f244	Cucumber	<i>Cucumis sativus</i> .
f246	Guar, guar gum	<i>Cyamopsis tetragonoloba</i> .
f247	Honey	NA.
f248	Rosemary	<i>Rosmarinus officinalis</i> .
f254	Plaice	<i>Pleuronectes platessa</i> .
f255	Plum	<i>Prunus domestica</i> , <i>Prunus americana</i> .
f258	Squid	<i>Loligo</i> spp.
f259	Grape	<i>Vitis vinifera</i> ( <i>Vitis</i> spp.).
f260	Broccoli	<i>Brassica oleracea</i> var. <i>italica</i> ( <i>Brassica oleracea</i> var. <i>cultivar</i> ).
f261	Asparagus	<i>Asparagus officinalis</i> .
f262	Aubergine, eggplant	<i>Solanum melongena</i> .
f263	Green pepper	<i>Piper nigrum</i> , <i>Capsicum annuum</i> .
f264	Eel	<i>Anguilla anguilla</i> .
f265	Caraway	<i>Carum carvi</i> .
f265	Cumin	<i>Cuminum cyminum</i> .
f266	Mace	<i>Myristica fragrans</i> .
f267	Cardamon	<i>Elettaria cardamomum</i> .
f268	Clove	<i>Syzygium aromaticum</i> .
f269	Basil	<i>Ocimum basilicum</i> .
f270	Ginger	<i>Zingiber officinale</i> .
f271	Anise	<i>Pimpinella anisum</i> .
f272	Tarragon	<i>Artemisia dracuncululus</i> .
f273	Thyme	<i>Thymus vulgaris</i> .
f274	Marjoram	<i>Origanum majorana</i> .
f275	Lovage	<i>Levisticum officinale</i> .
f276	Fennel, fresh	<i>Foeniculum vulgare</i> .
f277	Dill	<i>Anethum graveolens</i> .
f278	Bay leaf	<i>Laurus nobilis</i> .
f279	Chili pepper	<i>Capsicum frutescens</i> .
f280	Black pepper	<i>Piper nigrum</i> .
f281	Curry (Santa Maria)	NA.
f282	Nutmeg	<i>Myristica fragrans</i> .
f283	Oregano	<i>Origanum vulgare</i> .
f284	Turkey meat	<i>Meleagris gallopavo</i> .
f285	Elk/moose meat	<i>Alces</i> spp.
f286	Mare's milk	<i>Equus caballus</i> ( <i>Equus</i> spp.).
f287	Red kidney bean	<i>Phaseolus vulgaris</i> .
f288	Blueberry	<i>Vaccinium myrtillus</i> ( <i>Vaccinium</i> spp.).
f289	Date	<i>Phoenix dactylifera</i> .
f291	Cauliflower	<i>Brassica oleracea</i> var. <i>botrytis</i> .
f292	Guava	<i>Psidium guajava</i> .

TABLE 1—CLASS II EXEMPT ALLERGENS UNDER § 866.5750—RADIOALLERGOSORBENT (RAST) IMMUNOLOGICAL TEST SYSTEMS—Continued

Allergen code	Allergen product	Source (taxonomical name)
f293	Papaya	<i>Carica papaya</i> .
f294	Passion fruit, Maracuja	<i>Passiflora edulis</i> ( <i>Passiflora</i> spp.).
f295	Carambola	<i>Averrhoa carambola</i> .
f296	Carob	<i>Ceratonia siliqua</i> .
f297	Gum Arabic	<i>Acacia senegal</i> ( <i>Acacia</i> spp.).
f298	Tragacanth	<i>Astragalus</i> spp.
f299	Sweet chestnut (chestnut)	<i>Castanea sativa</i> .
f300	Pinto bean	<i>Phaseolus</i> spp.
f301	Persimmon (kaki fruit, sharon)	<i>Diospyros kaki</i> .
f302	Mandarin (tangerine, clementine, satsumas)	<i>Citrus reticulata</i> .
f305	Fenugreek	<i>Trigonella foenum-graecum</i> .
f306	Lime	<i>Citrus aurantifolia</i> .
f307	Hake	<i>Merluccius merluccius</i> .
f308	Sardine (pilchard)	<i>Sardina pilchardus</i> .
f310	Blue vetch	<i>Lathyrus sativus</i> .
f311	Megrim	<i>Lepidorhombus whiffiagonis</i> .
f315	Green bean	<i>Phaseolus vulgaris</i> .
f316	Rape seed	<i>Brassica napus</i> .
f317	Coriander	<i>Coriandrum sativum</i> .
f318	Jack fruit	<i>Artocarpus heterophyllus</i> .
f319	Beetroot	<i>Beta vulgaris</i> .
f320	Crayfish	<i>Astacus astacus</i> .
f321	Horse meat	<i>Equus caballus</i> ( <i>Equus</i> spp.).
f322	Red currant	<i>Ribes sylvestre</i> .
f324	Hop (fruit cone)	<i>Humulus lupulus</i> .
f325	Saffron	<i>Colchicum autumnale</i> .
f328	Fig	<i>Ficus carica</i> .
f329	Watermelon	<i>Citrullus lanatus</i> .
f330	Rose hip	<i>Rosa</i> spp.
f331	Saffron	<i>Crocus sativus</i> .
f332	Mint	<i>Mentha piperita</i> .
f333	Linseed	<i>Linum usitatissimum</i> .
f336	Jujube	<i>Ziziphus jujuba</i> .
f336	Wine vinegar	<i>Vitis vinifera</i> ( <i>Vitis</i> spp.).
f337	Sole	<i>Solea solea</i> .
f337	English sole	<i>Parophrys vetulus</i> .
f338	Wine, white	<i>Vitis vinifera</i> ( <i>Vitis</i> spp.).
f339	Allspice	<i>Pimenta dioica</i> .
f339	Wine, red	<i>Vitis vinifera</i> ( <i>Vitis</i> spp.).
f341	Cranberry	<i>Vaccinium oxycoccus</i> , <i>Vaccinium macrocarpon</i> .
f342	Olive (black, fresh)	<i>Olea europaea</i> .
f343	Raspberry	<i>Rubus idaeus</i> .
f344	Sage	<i>Salvia officinalis</i> .
f346	Chives	<i>Allium schoenoprasum</i> .
f347	Quinoa	<i>Chenopodium quinoa</i> .
f348	Litchi	<i>Litchi chinensis</i> .
f349	Chum salmon roe	<i>Oncorhynchus keta</i> .
f358	Artichoke	<i>Cynara scolymus</i> .
f360	Yogurt	NA.
f368	Black bass	<i>Micropterus dolomieu</i> ( <i>Micropterus dolomieu</i> ).
f374	Karaya gum	<i>Sterculia urens</i> .
f375	Horseradish	<i>Armoracia rusticana</i> .
f377	Maple syrup	NA.
f379	Okra	<i>Abelmoschus esculentus</i> .
f382	Beet, sugar	<i>Beta vulgaris</i> var. <i>altissima</i> .
f401	Loquat	<i>Eriobotrya japonica</i> .
f402	Fig	<i>Ficus carica</i> .
f403	Brewer's yeast	<i>Saccharomyces cerevisiae</i> .
f405	Mint	<i>Mentha</i> spp.
f406	Arugula	<i>Eruca vesicaria</i> .

House Dust

h1	Greer Labs., Inc	NA.
h2	Hollister-Stier Labs	NA.
h6	Japan	NA.

Venoms & Insects

i7	Midge	<i>Chironomus yoshimatsui</i> .
----	-------	---------------------------------



TABLE 1—CLASS II EXEMPT ALLERGENS UNDER § 866.5750—RADIOALLERGOSORBENT (RAST) IMMUNOLOGICAL TEST SYSTEMS—Continued

Allergen code	Allergen product	Source (taxonomical name)
i8	Moth	<i>Bombyx mori</i> , <i>Heterocera</i> spp.
i47	Water flea	<i>Daphnia</i> spp.
i49	Deer fly	<i>Chrysops</i> spp.
i51	Black ant	<i>Camponotus pennsylvanicus</i> .
i54	Flea mix (dog/cat), common flea	<i>Ctenocephalides</i> spp.
171	Mosquito	<i>Aedes communis</i> , <i>Aedes</i> spp. and <i>Culex</i> spp.
172	Green nimiti	<i>Cladotanytarsus lewisi</i> .
173	Blood worm	<i>Chironomus thummi</i> , <i>Chironomus parius</i> , <i>Chironomus</i> spp.
i75	European hornet	<i>Vespa crabro</i> .
i76	Berlin beetle	<i>Trogoderma angustum</i> .
177	European paper wasp	<i>Polistes dominulus</i> .
178	Fly	<i>Musca domestica</i> .
i80	Bumblebee	<i>Bombus pennsylvanicus</i> .
i201	Horse bot fly	<i>Gasterophilus intestinalis</i> .
i202	Grain weevil	<i>Sitophilus granarius</i> .
i203	Mediterranean flour moth	<i>Ephestia kuehniella</i> ( <i>Anagasta kuehniella</i> ).
i204	Horse fly	<i>Tabanus</i> spp.
i205	Bumblebee	<i>Bombus terrestris</i> .
i208	Api m 1.0101	<i>Apis mellifera</i> .
a45	Api m 1	<i>Apis mellifera</i> .
i209	Ves v 5.0101	<i>Vespula vulgaris</i> .
a670	Ves v 5	<i>Vespula vulgaris</i> .
i210	Pol d 5.0101	<i>Polistes dominulus</i> .
i211	Ves v 1.0101	<i>Vespula vulgaris</i> .
i213	Api m 4	<i>Apis mellifera</i> .
i214	Api m 2	<i>Apis mellifera</i> .
i215	Api m 3	<i>Apis mellifera</i> .
i216	Api m 5	<i>Apis mellifera</i> .
i217	Api m 10	<i>Apis mellifera</i> .
i220	Bla g 1.0101	<i>Blattella germanica</i> .
i221	Bla g 2.0101	<i>Blattella germanica</i> .
i222	Bla g 5.0101	<i>Blattella germanica</i> .
i223	Bla g 7	<i>Blattella germanica</i> .
a46	Api m 2	<i>Apis mellifera</i> .
<b>Miscellaneous</b>		
o1	Cotton, crude fibers	<i>Gossypium</i> spp.
o3	Cotton (treated)	<i>Gossypium</i> spp.
o70	Seminal fluid	<i>Homo sapiens</i> .
o71	<i>Staphylococcus aureus</i>	<i>Staphylococcus aureus</i> .
o72	<i>Pichia pastoris</i> crude extract customer specific	<i>Pichia pastoris</i> .
o72	Sperm-sediment	<i>Homo sapiens</i> .
o73	<i>Pichia pastoris</i> crude extr. vector customer specific	<i>Pichia pastoris</i> .
o74	<i>Pichia pastoris</i> with vector customer specific	<i>Pichia pastoris</i> .
o201	Tobacco leaf, tobacco dust	<i>Nicotiana tabacum</i> .
o202	Artemia salina, fish feed	<i>Artemia salina</i> .
o203	Tetramin, fish feed	NA.
o207	Daphnia, fish feed	<i>Daphnia</i> spp.
o211	Mealworm	<i>Tenebrio molitor</i> .
o212	Streptavidin	<i>Streptomyces avidinii</i> .
o213	MBP (maltose binding protein)	<i>Escherichia coli</i> .
o214	CCD; MUXF3 from bromelain	<i>Ananas comosus</i> .
o72	Enterotoxin A (Sta a SEA)	<i>Staphylococcus aureus</i> .
o73	Enterotoxin B (Sta a SEB)	<i>Staphylococcus aureus</i> .
<b>Parasites</b>		
p1	Ascaris	<i>Ascaris suum</i> .
p2	Echinococcus	<i>Echinococcus granulosus</i> .
p3	Schistosoma	<i>Schistosoma mansoni</i> .
p4	Anisakis (Herring Worm)	<i>Anisakis simplex</i> ( <i>Anisakis</i> spp.).
p5	Toxocara canis	<i>Toxocara canis</i> .
p10	Ani s 3.0101	<i>Anisakis simplex</i> ( <i>Anisakis</i> spp.).
p11	Ani s 1	<i>Anisakis simplex</i> ( <i>Anisakis</i> spp.).
<b>Occupational</b>		
k4	Threshing dust	NA.

TABLE 1—CLASS II EXEMPT ALLERGENS UNDER § 866.5750—RADIOALLERGOSORBENT (RAST) IMMUNOLOGICAL TEST SYSTEMS—Continued

Allergen code	Allergen product	Source (taxonomical name)
k5	Flax	NA.
k7	Hay Dust	NA.
k8	Hop (hops)	<i>Humulus lupulus</i> .
k12	Grain mill dust	NA.
k14	Kapok	NA.
k20	Sheep's wool (treated) (wool)	<i>Ovis aries</i> ( <i>Ovis</i> spp.).
k21	Sheep's wool (Untreated)	<i>Ovis aries</i> ( <i>Ovis</i> spp.).
k23	Straw Dust	NA.
k33	Oak	NA.
k70	Green coffee bean	<i>Coffea</i> spp.
k71	Castor bean	<i>Ricinus communis</i> .
k72	Ispaghula	<i>Plantago psyllium/Plantago ovata</i> .
k73	Silk waste	NA.
k74	Silk	<i>Bombyx mori</i> .
k75	Isocyanate TDI (Toluene diisocyanate)	NA.
k76	Isocyanate MDI (Diphenylmethane diisocyanate)	NA.
k77	Isocyanate HDI (Hexamethylen diisocyanate)	NA.
k78	Ethylene oxide	NA.
k79	Phthalic anhydride	NA.
k80	Formaldehyde/Formalin	NA.
k81	Ficus	<i>Ficus benjamina</i> ( <i>Ficus</i> spp.).
k83	Cotton seed	<i>Gossypium hirsutum</i> .
k84	Sunflower seed	<i>Helianthus annuus</i> .
k85	Chloramin T	NA.
k86	Trimellitic anhydride, TMA	NA.
k87	Asp o 21, alpha-amylase	<i>Aspergillus oryzae</i> .
k89	Orris root	<i>Iris florentina</i> .
k99	HSA (Human Serum Albumin) (Hom s HSA)	<i>Homo sapiens</i> .
k201	Car p 1, Papain	<i>Carica papaya</i> .
k202	Ana c 2, Bromelain	<i>Ananas comosus</i> .
k204	Maxatase	<i>Bacillus licheniformis</i> .
k205	Alcalase	<i>Bacillus</i> spp.
k206	Savinase, Protease 1 (Bac I Subtilisin)	<i>Bacillus</i> spp.
k208	Gal d 4, Lysozyme	<i>Gallus domesticus</i> ( <i>Gallus gallus domesticus</i> ; <i>Gallus</i> spp.).
k209	Hexahydrophthalic anhydrid	NA.
k210	Maleic anhydride	NA.
k211	Methyltetrahydrophthalic anhydrid	NA.
k212	Abachi wood dust	<i>Triplachiton scleroxylon</i> .
k213	Pepsin (Sus s Pepsin)	<i>Sus scrofa</i> ( <i>Sus scrofa domesticus</i> ; <i>Sus</i> spp.).
k213	TCPA	NA.
k214	Bougainvillea	<i>Bougainvillea</i> spp.
k225	Horse radish peroxidase (Arm r HRP)	<i>Armoracia rusticana</i> .
k226	Ascorbate oxidase (Cuc p ascorbate oxidase)	<i>Cucurbita pepo</i> .
k301	Flour dust	<i>Triticum</i> spp.
k501	Savinase customer specific	Proprietary knowledge of customer.
k502	Lipolase customer specific	Proprietary knowledge of customer.
k503	Termamyl customer specific	Proprietary knowledge of customer.
k504	Clazinase customer specific	Proprietary knowledge of customer.

[47 FR 50823, Nov. 9, 1982, as amended at 84 FR 71800, Dec. 30, 2019]

**§ 866.5760 Tryptase test system.**

(a) *Identification.* A tryptase test system is a device that aids in the diagnosis of systemic mastocytosis. It is intended for in vitro diagnostic use as an aid in the clinical diagnosis of patients with a suspicion of systemic mastocytosis in conjunction with other clinical and laboratory findings.

(b) *Classification.* Class II (special controls). The special control is FDA's

guideline entitled "Class II Special Controls Guideline: Tryptase Test System as an Aid in the Diagnosis of Systemic Mastocytosis." For availability of the document, see § 866.1(e).

[79 FR 56010, Sept. 18, 2014]

**§ 866.5765 Retinol-binding protein immunological test system.**

(a) *Identification.* A retinol-binding protein immunological test system is a

device that consists of the reagents used to measure by immunochemical techniques the retinol-binding protein that binds and transports vitamin A in serum and urine. Measurement of this protein may aid in the diagnosis of kidney disease and in monitoring patients with kidney transplants.

(b) *Classification*. Class I (general controls). The device is exempt from the premarket notification procedures in subpart E of part 807 of this chapter subject to § 866.9.

[47 FR 50823, Nov. 9, 1982, as amended at 65 FR 2313, Jan. 14, 2000]

**§ 866.5775 Rheumatoid factor immunological test system.**

(a) *Identification*. A rheumatoid factor immunological test system is a device that consists of the reagents used to measure by immunochemical techniques the rheumatoid factor (antibodies to immunoglobulins) in serum, other body fluids, and tissues. Measurement of rheumatoid factor may aid in the diagnosis of rheumatoid arthritis.

(b) *Classification*. Class II (performance standards).

**§ 866.5785 Anti-Saccharomyces cerevisiae (S. cerevisiae) antibody (ASCA) test systems.**

(a) *Identification*. The Anti-Saccharomyces cerevisiae (S. cerevisiae) antibody (ASCA) test system is an in vitro diagnostic device that consists of the reagents used to measure, by immunochemical techniques, antibodies to S. cerevisiae (baker's or brewer's yeast) in human serum or plasma. Detection of S. cerevisiae antibodies may aid in the diagnosis of Crohn's disease.

(b) *Classification*. Class II (special controls). The special control is FDA's "Guidance for Industry and FDA Reviewers: Class II Special Control Guidance Document for Anti-Saccharomyces cerevisiae (S. cerevisiae) Antibody (ASCA) Premarket Notifications."

[65 FR 70307, Nov. 22, 2000]

**§ 866.5800 Seminal fluid (sperm) immunological test system.**

(a) *Identification*. A seminal fluid (sperm) immunological test system is a device that consists of the reagents used for legal purposes to identify and

differentiate animal and human semen. The test results may be used as court evidence in alleged instances of rape and other sex-related crimes.

(b) *Classification*. Class I (general controls). The device is exempt from the premarket notification procedures in subpart E of part 807 of this chapter subject to the limitations in § 866.9.

[54 FR 25047, June 12, 1989, as amended at 66 FR 38793, July 25, 2001]

**§ 866.5820 Systemic lupus erythematosus immunological test system.**

(a) *Identification*. A systemic lupus erythematosus (SLE) immunological test system is a device that consists of the reagents used to measure by immunochemical techniques the auto-immune antibodies in serum and other body fluids that react with cellular nuclear double-stranded deoxyribonucleic acid (DNA) or other nuclear constituents that are specifically diagnostic of SLE. Measurement of nuclear double-stranded DNA antibodies aids in the diagnosis of SLE (a multisystem autoimmune disease in which tissues are attacked by the person's own antibodies).

(b) *Classification*. Class II (performance standards).

**§ 866.5830 Brain trauma assessment test.**

(a) *Identification*. A brain trauma assessment test is a device that consists of reagents used to detect and measure brain injury biomarkers in human specimens. The measurements aid in the evaluation of patients with suspected mild traumatic brain injury in conjunction with other clinical information to assist in determining the need for head imaging per current standard of care.

(b) *Classification*. Class II (special controls). The special controls for this device are:

(1) The 21 CFR 809.10(b) compliant labeling must include detailed descriptions of and results from performance testing conducted to evaluate precision, accuracy, linearity, analytical sensitivity, interference, and cross-reactivity. This information must include the following:

(i) Performance testing of device precision must, at minimum, use one unmodified clinical specimen from the intended use population with concentration of the brain injury biomarker(s) near the medical decision point. Contrived specimens that have been generated from pooling of multiple samples or spiking of purified analyte to cover the measuring range may be used, but the contrived samples must be prepared to mimic clinical specimens as closely as possible. This testing must evaluate repeatability and reproducibility using a protocol from an FDA-recognized standard.

(ii) Device performance data must be demonstrated through a clinical study and must include the following:

(A) Data demonstrating clinical validity including the clinical sensitivity and specificity, and positive and negative predictive value of the test in the intended use population of patients with suspected mild traumatic brain injury (*i.e.*, Glasgow Coma Score (GCS) of 13–15), or equivalent standard of care for determination of severity of traumatic brain injury (TBI).

(B) Study must be performed using the operators and in settings that are representative of the types of operators and settings for which the device is intended to be used.

(C) All eligible subjects must meet the well-defined study inclusion and exclusion criteria that define the intended use population. The prevalence of diseased or injured subjects in the study population must reflect the prevalence of the device's intended use population, or alternatively, statistical measures must be used to account for any bias due to enrichment of subpopulations of the intended use population.

(D) All eligible subjects must have undergone a head computerized tomography (CT) scan or other appropriate clinical diagnostic standard used to determine the presence of an intracranial lesion as part of standard of care and must also be evaluated by the subject device. All clinical diagnostic standards used in the clinical study must follow standard clinical practice in the United States.

(E) Relevant demographic variables and baseline characteristics including

medical history and neurological history. In addition, head injury characteristics, neurological assessments, and physical evidence of trauma must be provided for each subject. This information includes but is not limited to the following: Time since head injury, time from head injury to CT scan, time from head injury to blood draw, GCS score or equivalent, experience of loss of consciousness, presence of confusion, episodes of vomiting, post-traumatic amnesia characteristics, presence of post-traumatic seizures, drug or alcohol intoxication, mechanism of injury, acute intracranial lesion type, neurosurgical lesion, and cranial fracture.

(F) Each CT scan or other imaging result must be independently evaluated in a blinded manner by at least two board-certified radiologists to determine whether it is positive or negative as defined by the presence or absence of acute intracranial lesions. This independent review must be conducted without access to test results of the device. Prior to conducting the review, the criteria and procedures to be followed for scoring the images must be established, including the mechanism for determining consensus.

(G) All the clinical samples must be tested with the subject device blinded to the TBI status and the neurological-lesion-status of the subject.

(H) Details on how missing values in data are handled must be provided.

(I) For banked clinical samples, details on storage conditions and storage period must be provided. In addition, a specimen stability study must be conducted for the duration of storage to demonstrate integrity of archived clinical samples. The samples evaluated in the assay test development must not be used to establish the clinical validity of the assays.

(iii) Performance testing of device analytical specificity must include the most commonly reported concomitant medications present in specimens from the intended use population. Additionally, potential cross-reacting endogenous analytes must be evaluated at the highest concentration reported in specimens from the intended use population.

(iv) Expected/reference values generated by testing a statistically appropriate number of samples from apparently healthy normal individuals.

(2) The 21 CFR 809.10(a) and (b) compliant labeling must include the following limitations:

(i) A limiting statement that this device is not intended to be used a stand-alone device but as an adjunct to other clinical information to aid in the evaluation of patients who are being considered for standard of care neuroimaging.

(ii) A limiting statement that reads “A negative result is generally associated with the absence of acute intracranial lesions. An appropriate neuroimaging method is required for diagnosis of acute intracranial lesions.”

(iii) As applicable, a limiting statement that reads “This device is for use by laboratory professionals in a clinical laboratory setting.”

[83 FR 27701, June 14, 2018]

**§ 866.5860 Total spinal fluid immunological test system.**

(a) *Identification.* A total spinal fluid immunological test system is a device that consists of the reagents used to measure by immunochemical techniques the total protein in cerebrospinal fluid. Measurement of spinal fluid proteins may aid in the diagnosis of multiple sclerosis and other diseases of the nervous system.

(b) *Classification.* Class I (general controls). The device is exempt from the premarket notification procedures in subpart E of part 807 of this chapter subject to the limitations in § 866.9.

[47 FR 50823, Nov. 9, 1982, as amended at 61 FR 1119, Jan. 16, 1996; 66 FR 38793, July 25, 2001]

**§ 866.5870 Thyroid autoantibody immunological test system.**

(a) *Identification.* A thyroid autoantibody immunological test system is a device that consists of the reagents used to measure by immunochemical techniques the thyroid autoantibodies (antibodies produced against the body’s own tissues). Measurement of thyroid autoantibodies may aid in the diagnosis of certain thyroid disorders, such as Hashimoto’s dis-

ease (chronic lymphocytic thyroiditis), nontoxic goiter (enlargement of thyroid gland), Grave’s disease (enlargement of the thyroid gland with protrusion of the eyeballs), and cancer of the thyroid.

(b) *Classification.* Class II (performance standards).

**§ 866.5880 Transferrin immunological test system.**

(a) *Identification.* A transferrin immunological test system is a device that consists of the reagents used to measure by immunochemical techniques the transferrin (an iron-binding and transporting serum protein) in serum, plasma, and other body fluids. Measurement of transferrin levels aids in the diagnosis of malnutrition, acute inflammation, infection, and red blood cell disorders, such as iron deficiency anemia.

(b) *Classification.* Class II (performance standards).

**§ 866.5890 Inter- $\alpha$  trypsin inhibitor immunological test system.**

(a) *Identification.* An inter- $\alpha$  trypsin inhibitor immunological test system is a device that consists of the reagents used to measure by immunochemical techniques the inter- $\alpha$  trypsin inhibitor (a protein) in serum and other body fluids. Measurement of inter- $\alpha$  trypsin inhibitor may aid in the diagnosis of acute bacterial infection and inflammation.

(b) *Classification.* Class I (general controls). The device is exempt from the premarket notification procedures in subpart E of part 807 of this chapter subject to § 866.9.

[47 FR 50823, Nov. 9, 1982, as amended at 53 FR 11253, Apr. 6, 1988; 65 FR 2313, Jan. 14, 2000]

**§ 866.5900 Cystic fibrosis transmembrane conductance regulator (CFTR) gene mutation detection system.**

(a) *Identification.* The CFTR gene mutation detection system is a device used to simultaneously detect and identify a panel of mutations and variants in the CFTR gene. It is intended as an aid in confirmatory diagnostic testing of individuals with suspected cystic fibrosis (CF), carrier

**§ 866.5910**

identification, and newborn screening. This device is not intended for stand-alone diagnostic purposes, prenatal diagnostic, pre-implantation, or population screening.

(b) *Classification.* Class II (special controls). The special control is FDA's guidance document entitled "Class II Special Controls Guidance Document: CFTR Gene Mutation Detection System." See § 866.1(e) for the availability of this guidance document.

[70 FR 61738, Oct. 26, 2005]

**§ 866.5910 Quality control material for cystic fibrosis nucleic acid assays.**

(a) *Identification.* Quality control material for cystic fibrosis nucleic acid assays. A quality control material for cystic fibrosis nucleic acid assays is a device intended to help monitor reliability of a test system by detecting analytical deviations such as those that may arise from reagent or instrument variation in genetic testing. This type of device includes recombinant, synthetic, and cell line-based DNA controls.

(b) *Classification.* Class II (special controls). The device is exempt from the premarket notification procedures in subpart E of part 807 of this chapter subject to the limitations in § 866.9. The special control is FDA's guidance document entitled "Class II Special Controls Guidance Document: Quality Control Material for Cystic Fibrosis Nucleic Acid Assays." See § 866.1(e) for the availability of this guidance document.

[72 FR 1176, Jan. 10, 2007, as amended at 84 FR 71811, Dec. 30, 2019]

**§ 866.5930 Newborn screening test for severe combined immunodeficiency disorder (SCID).**

(a) *Identification.* A newborn screening test for SCID is a prescription device intended to measure T-cell receptor excision circle (TREC) DNA obtained from dried blood spot specimens on filter paper using a polymerase chain reaction based test as an aid in screening newborns for SCID. Presumptive positive results must be followed up by diagnostic confirmatory testing. This test is not intended for use as a diagnostic test, or for screening of SCID-like syndromes, such as DiGeorge syndrome or Omenn syndrome. It is

**21 CFR Ch. I (4-1-20 Edition)**

also not intended to screen for less acute SCID syndromes, such as leaky SCID or variant SCID.

(b) *Classification.* Class II (special controls). The special controls for this device are:

(1) Premarket notification submissions must include the following information:

(i) The intended use must indicate:

(A) The test is not intended for diagnostic use, or for screening of SCID-like syndromes, such as DiGeorge syndrome or Omenn syndrome; and

(B) The test is not intended to screen for less acute SCID syndromes, such as leaky SCID or variant SCID.

(ii) A detailed description of all components in the test that includes:

(A) A detailed description of the test components, all required reagents, instrumentation and equipment, including illustrations or photographs of non-standard equipment or methods;

(B) Detailed documentation of the device software including, but not limited to, standalone software applications and hardware-based devices that incorporate software;

(C) Specifications for the filter paper, which must be appropriately labeled for in vitro diagnostic use, to be used in specimen collection and how it will be used in specimen collection validation. These specifications must include: descriptive characteristics of the filter paper, instructions on how a lab should choose the appropriate filter paper, chemical properties of the filter paper, interference concerns associated with the chemicals in the filter paper, absorption properties of the filter paper, punch size, absorption capacity, testing for homogeneity of punches, diameter of the circle for the dried blood spot aliquot, absorption time, physical composition, and number and size of punches to be tested;

(D) Methodology and protocols for detection of T-cell receptor excision circles and methods for determination of results. The cutoff must be selected before conducting clinical and analytical studies;

(E) A description of the result outputs along with sample reports. Sample reports must include the scale used in reporting of results (*e.g.*, TREC copies/

µL) and the range of values that will be reported out; and

(F) A description of appropriate internal and external controls that are recommended or provided. The description must identify those control elements that are incorporated into the testing procedure.

(iii) Information that demonstrates the performance characteristics of the test, including:

(A) Data that demonstrates the clinical validity of the device, using well characterized prospectively or retrospectively obtained clinical specimens representative of the intended use population. A minimum of 10 to 15 confirmed positive specimens must be obtained from more than 1 site, including relevant annotation, and, at 1 year or beyond, a SCID diagnosis by flow cytometry or clinically meaningful information regarding the status of the subject must be obtained. Additional specimens should have been obtained that are characterized by other disorders that can be found by screening specimens that have low or absent TREC (*e.g.*, other T-cell lymphopenic disorders) to supplement the range of results. The clinical validation study must have a pre-specified clinical decision point (*i.e.*, cutoff to distinguish positive and negative results). Results must be summarized in tabular format comparing interpretation of results to the reference method. Point estimates together with two-sided 95 percent confidence intervals must be provided for the positive percent agreement, negative percent agreement, and overall percent agreement. Data must include the retest rate, the false positive rate before retest, the final false positive rate, and the false negative rate;

(B) Device reproducibility data generated, using a minimum of three sites of which at least two must be external sites, with two operators at each site. Each site must conduct a minimum of five runs per operator over five non-consecutive days evaluating a minimum of six different relevant TREC concentrations that span and are well distributed over the measuring range and include the clinical cutoff. Specimens must include cord blood and cord blood diluted with ABO matched adult blood specimens. Identical specimens

from the same sample panel must be tested at each site. Each specimen must be run in triplicate and include controls run in triplicate. Results must be reported as the standard deviation and percentage coefficient of variation for each level tested. Results must also be displayed as a dichotomous variable around the cutoff. Total variation must be partitioned into the sum of within-lab and between-lab variations with pre-specified acceptance criteria and 95 percent confidence intervals for all data. Pre-specified acceptance criteria must be provided and followed;

(C) Device precision data using clinical samples to evaluate the within-lot, between-lot, within-run, between run, and total variation. A range of TREC levels of the specimen must include samples within the measuring range, samples above and below the measuring range, as well as with samples very near above and below the cutoff value. At least three replicates of each specimen must be tested with controls and calibrator(s) according to the device instructions for use. The precision study must use well characterized samples using different lots, instruments, and operators. Results must be summarized in tabular format. Pre-specified acceptance criteria must be provided and followed;

(D) Linearity of the test must be demonstrated using a dilution panel from clinical samples. The range of dilution samples must include samples within the measuring range, samples above and below the measuring range, as well as with samples very near above and below the cutoff value. Results of the regression analysis must be summarized in tabular format and fitted into a linear regression model with the individual measurement results against the dilution factors. Pre-specified acceptance criteria must be provided and followed;

(E) Device analytic sensitivity data, including limit of blank, limit of detection, and limit of quantification;

(F) Device specificity data, including interference, carryover, cross-contamination, and *in silico* analysis of potential off-target genomic sequences;

(G) Device stability data, including real-time stability of samples under various storage times, temperatures,

and freeze-thaw conditions. A separate shipping stability study must be performed;

(H) Lot-to-lot reproducibility study of each filter paper that will be validated with the test. The lot-to-lot study must include a minimum of three lots of each blood spot card that will be validated with the test and be conducted over five nonconsecutive days. The sample panel must consist of specimens with a range of TREC levels and include samples within the measuring range, samples above and below the measuring range, and samples very near above and below the cutoff value. Multiple punches must be obtained from each card for demonstration of homogeneity of the analyte across the dried blood spot. Comparability of the test performance for each filter paper must be demonstrated. Stability and storage of TREC DNA on each blood spot card must be demonstrated. Results of the lot-to-lot study must be summarized providing the mean, standard deviation, and percentage coefficient of variation in a tabular format. Data must be calculated for within-run, between-run, within-lot, and between-lot. Data demonstrating the concordance between results across different filter papers must be provided. Study acceptance criteria must be provided and followed; and

(I) If applicable, a thermocycler reproducibility study must be performed using thermocyclers from three independent thermocycler manufacturers. The sample panel must consist of specimens with a range of TREC levels and must include samples within the measuring range, samples above and below the measuring range, and samples very near above and below the cutoff value. The study must be done using three filter paper lots and conducted over five nonconsecutive days. Results of the thermocycler reproducibility study must be summarized providing the mean, standard deviation, and percentage coefficient of variance in a tabular format. Data must be calculated for the within-run, between-run, within-lot, between-lot, and between thermocycler manufacturer study results. Study acceptance criteria must be provided and followed.

(iv) Identification of risk mitigation elements used by your device, including a description of all additional procedures, methods, and practices incorporated into the directions for use that mitigate risks associated with testing.

(2) Your § 809.10 compliant labeling must include:

(i) A warning statement that reads “This test is not intended for diagnostic use, preimplantation or prenatal testing, or for screening of SCID-like syndromes, such as DiGeorge syndrome or Omenn syndrome. It is also not intended to screen for less acute SCID syndromes, such as leaky SCID or variant SCID.”;

(ii) A warning statement that reads “Test results are intended to be used in conjunction with other clinical and diagnostic findings, consistent with professional standards of practice, including confirmation by alternative methods and clinical evaluation, as appropriate.”;

(iii) A description of the performance studies listed in paragraph (b)(1)(iii) and a summary of the results; and

(iv) A description of the filter paper specifications required for the test.

[82 FR 50079, Oct. 30, 2017]

**§ 866.5940 Autosomal recessive carrier screening gene mutation detection system.**

(a) *Identification.* Autosomal recessive carrier screening gene mutation detection system is a qualitative in vitro molecular diagnostic system used for genotyping of clinically relevant variants in genomic DNA isolated from human specimens intended for prescription use or over-the-counter use. The device is intended for autosomal recessive disease carrier screening in adults of reproductive age. The device is not intended for copy number variation, cytogenetic, or biochemical testing.

(b) *Classification.* Class II (special controls). The device is exempt from the premarket notification procedures in subpart E of part 807 of this chapter subject to the limitations in § 866.9, except § 866.9(c)(2). Autosomal recessive carrier screening gene mutation detection system must comply with the following special controls:



(1) If the device is offered over-the-counter, the device manufacturer must provide information to a potential purchaser or actual test report recipient about how to obtain access to a board-certified clinical molecular geneticist or equivalent to assist in pre- and post-test counseling.

(2) The device must use a collection device that is FDA cleared, approved, or classified as 510(k) exempt, with an indication for in vitro diagnostic use in DNA testing.

(3) The device's labeling must include a prominent hyperlink to the manufacturer's public Web site where the manufacturer shall make the information identified in this section publicly available. The manufacturer's home page, as well as the primary part of the manufacturer's Web site that discusses the device, must provide a prominently placed hyperlink to the Web page containing this information and must allow unrestricted viewing access. If the device can be purchased from the Web site or testing using the device can be ordered from the Web site, the same information must be found on the Web page for ordering the device or provided in a prominently placed and publicly accessible hyperlink on the Web page for ordering the device. Any changes to the device that could significantly affect safety or effectiveness would require new data or information in support of such changes, which would also have to be posted on the manufacturer's Web site. The information must include:

(i) A detailed device description including:

(A) Gene (or list of the genes if more than one) and variants the test detects (using standardized nomenclature, Human Genome Organization (HUGO) nomenclature, and coordinates).

(B) Scientifically established clinical validity of each variant detected and reported by the test, which must be well-established in peer-reviewed journal articles, authoritative summaries of the literature such as Genetics Home Reference (<http://ghr.nlm.nih.gov/>), GeneReviews (<http://www.ncbi.nlm.nih.gov/books/NBK1116/>), or similar summaries of valid scientific evidence, and/or professional society recommendations, including:

(1) Genotype-phenotype information for the reported mutations.

(2) Relevant American College of Medical Genetics (ACMG) or American Congress of Obstetricians and Gynecologists (ACOG) guideline recommending testing of the specific gene(s) and variants the test detects and recommended populations, if available. If not available, a statement stating that professional guidelines currently do not recommend testing for this specific gene(s) and variants.

(3) Table of expected prevalence of carrier status in major ethnic and racial populations and the general population.

(C) The specimen type (*e.g.*, saliva, whole blood), matrix, and volume.

(D) Assay steps and technology used.

(E) Specification of required ancillary reagents, instrumentation, and equipment.

(F) Specification of the specimen collection, processing, storage, and preparation methods.

(G) Specification of risk mitigation elements and description of all additional procedures, methods, and practices incorporated into the directions for use that mitigate risks associated with testing.

(H) Information pertaining to the probability of test failure (*e.g.*, failed quality control) based on data from clinical samples, description of scenarios in which a test can fail (*i.e.*, low sample volume, low DNA concentration, etc.), how customers will be notified, and followup actions to be taken.

(I) Specification of the criteria for test result interpretation and reporting.

(ii) Information that demonstrates the performance characteristics of the device, including:

(A) Accuracy (method comparison) of study results for each claimed specimen type.

(1) Accuracy of the device shall be evaluated with fresh clinical specimens collected and processed in a manner consistent with the device's instructions for use. If this is impractical, fresh clinical samples may be substituted or supplemented with archived clinical samples. Archived samples shall have been collected previously in

accordance with the device's instructions for use, stored appropriately, and randomly selected. In some instances, use of contrived samples or human cell line samples may also be appropriate; the contrived or human cell line samples shall mimic clinical specimens as much as is feasible and provide an unbiased evaluation of the device's accuracy.

(2) Accuracy must be evaluated as compared to bidirectional sequencing or other methods identified as appropriate by FDA. Performance criteria for both the comparator method and device must be predefined and appropriate to the test's intended use. Detailed appropriate study protocols must be provided.

(3) Information provided shall include the number and type of specimens, broken down by clinically relevant variants, that were compared to bidirectional sequencing or other methods identified as appropriate by FDA. The accuracy, defined as positive percent agreement (PPA) and negative percent agreement (NPA), must be measured; accuracy point estimates must be greater than 99 percent (both per reported variant and overall) and uncertainty of the point estimate must be presented using the 95 percent confidence interval. Clinical specimens must include both homozygous wild type and heterozygous genotypes. The number of clinical specimens for each variant reported that must be included in the accuracy study must be based on the variant prevalence. Common variants (greater than 0.1 percent allele frequency in ethnically relevant population) must have at least 20 unique heterozygous clinical specimens tested. Rare variants (less than or equal to 0.1 percent allele frequency in ethnically relevant population) shall have at least three unique mutant heterozygous specimens tested. Any no calls (*i.e.*, absence of a result) or invalid calls (*e.g.*, failed quality control) in the study must be included in accuracy study results and reported separately. Variants that have a point estimate for PPA or NPA of less than 99 percent (incorrect test results as compared to bidirectional sequencing or other methods identified as appropriate by FDA) must not be incorporated into

test claims and reports. Accuracy measures generated from clinical specimens versus contrived samples or cell lines must be presented separately. Results must be summarized and presented in tabular format, by sample and by genotype. Point estimate of PPA should be calculated as the number of positive results divided by the number of specimens known to harbor variants (mutations) without "no calls" or invalid calls. The point estimate of NPA should be calculated as the number of negative results divided by the number of wild type specimens tested without "no calls" or invalid calls, for each variant that is being reported. Point estimates should be calculated along with 95 percent two-sided confidence intervals.

(4) Information shall be reported on the clinical positive predictive value (PPV) and negative predictive value (NPV) for carrier status (and where possible, for each variant) in each population. Specifically, to calculate PPV and NPV, estimate test coverage (TC) and the percent of persons with variant(s) included in the device among all carriers:  $PPV = (PPA * TC * \pi) / (PPA * TC * \pi + (1 - NPA) * (1 - \pi))$  and  $NPV = (NPA * (1 - \pi)) / (NPA * (1 - \pi) + (1 - PPA * TC) * \pi)$  where PPA and NPA described either in paragraph (b)(3)(ii)(A)(4)(i) or in paragraph (b)(3)(ii)(A)(4)(ii) of this section and  $\pi$  is prevalence of carriers in the population (pre-test risk to be a carrier for the disease).

(i) For the point estimates of PPA and NPA less than 100 percent, use the calculated estimates in the PPV and NPV calculations.

(ii) Point estimates of 100 percent may have high uncertainty. If these variants are measured using highly multiplexed technology, calculate the random error rate for the overall device and incorporate that rate in the estimation of the PPA and NPA as calculated previously. Then use these calculated estimates in the PPV and NPV calculations. This type of accuracy study is helpful in determining that there is no systematic error in such devices.

(B) Precision (reproducibility): Precision data must be generated using multiple instruments and multiple operators, on multiple non-consecutive days, and using multiple reagent lots. The sample panel must include specimens with claimed sample type (*e.g.* saliva samples) representing different genotypes (*i.e.*, wild type, heterozygous). Performance criteria must be predefined. A detailed study protocol must be created in advance of the study and then followed. The “failed quality control” rate must be indicated. It must be clearly documented whether results were generated from clinical specimens, contrived samples, or cell lines. The study results shall state, in a tabular format, the variants tested in the study and the number of replicates for each variant, and what testing conditions were studied (*i.e.*, number of runs, days, instruments, reagent lots, operators, specimens/type, etc). The study must include all nucleic acid extraction steps from the claimed specimen type or matrix, unless a separate extraction study for the claimed sample type is performed. If the device is to be used at more than one laboratory, different laboratories must be included in the precision study (and reproducibility must be evaluated). The percentage of “no calls” or invalid calls, if any, in the study must be provided as a part of the precision (reproducibility) study results.

(C) Analytical specificity data: Data must be generated evaluating the effect on test performance of potential endogenous and exogenous interfering substances relevant to the specimen type, evaluation of cross-reactivity of known cross-reactive alleles and pseudogenes, and assessment of cross-contamination.

(D) Analytical sensitivity data: Data must be generated demonstrating the minimum amount of DNA that will enable the test to perform accurately in 95 percent of runs.

(E) Device stability data: The manufacturer must establish upper and lower limits of input nucleic acid and sample stability that will achieve the claimed accuracy and reproducibility. Data supporting such claims must be described.

(F) Specimen type and matrix comparison data: Specimen type and matrix comparison data must be generated if more than one specimen type or anticoagulant can be tested with the device, including failure rates for the different specimen types.

(iii) If the device is offered over-the-counter, including cases in which the test results are provided direct-to-consumer, the manufacturer must conduct a study that assesses user comprehension of the device’s labeling and test process and provide a concise summary of the results of the study. The following items must be included in the user study:

(A) The test manufacturer must perform pre- and post-test user comprehension studies to assess user ability to understand the possible results of a carrier test and their clinical meaning. The comprehension test questions must directly evaluate the material being presented to the user in the test reports.

(B) The test manufacturer must provide a carrier testing education module to potential and actual test report recipients. The module must define terms that are used in the test reports and explain the significance of carrier status.

(C) The user study must meet the following criteria:

(1) The study participants must be comprised of a statistically justified and demographically diverse population (determined using methods such as quota-based sampling) that is representative of the intended user population. Furthermore, the users must be comprised of a diverse range of age and educational levels that have no prior experience with the test or its manufacturer. These factors shall be well-defined in the inclusion and exclusion criteria.

(2) All sources of bias (*e.g.*, non-responders) must be predefined and accounted for in the study results with regard to both responders and non-responders.

(3) The testing must follow a format where users have limited time to complete the studies (such as an onsite survey format and a one-time visit with a cap on the maximum amount of time

that a participant has to complete the tests).

(4) Users must be randomly assigned to study arms. Test reports given to users must: Define the condition being tested and related symptoms; explain the intended use and limitations of the test; explain the relevant ethnicities regarding the variant tested; explain carrier status and relevance to the user's ethnicity; and provide links to additional information pertaining to situations where the user is concerned about their test results or would like followup information as indicated in test labeling. The study shall assess participants' ability to understand the following comprehension concepts: The test's limitations, purpose, and results.

(5) Study participants must be untrained, naive to the test subject of the study, and be provided only the materials that will be available to them when the test is marketed.

(6) The user comprehension study must meet the predefined primary endpoint criteria, including a minimum of a 90 percent or greater overall comprehension rate (*i.e.* selection of the correct answer) for each comprehension concept to demonstrate that the education module and test reports are adequate for over-the-counter use.

(D) A summary of the user comprehension study must be provided and include the following:

(1) Results regarding reports that are provided for each gene/variant/ethnicity tested.

(2) Statistical methods used to analyze all data sets.

(3) Completion rate, non-responder rate, and reasons for non-response/data exclusion, as well as a summary table of comprehension rates regarding comprehension concepts (purpose of test, test results, test limitations, ethnicity relevance for the test results, etc.) for each study report.

(4) Your 21 CFR 809.10 compliant labeling and any test report generated must include the following warning and limitation statements, as applicable:

(i) A warning that reads "The test is intended only for autosomal recessive carrier screening in adults of reproductive age."

(ii) A statement accurately disclosing the genetic coverage of the test in lay terms, including, as applicable, information on variants not queried by the test, and the proportion of incident disease that is not related to the gene(s) tested. For example, where applicable, the statement would have to include a warning that the test does not or may not detect all genetic variants related to the genetic disease, and that the absence of a variant tested does not rule out the presence of other genetic variants that may be disease-related. Or, where applicable, the statement would have to include a warning that the basis for the disease for which the genetic carrier status is being tested is unknown or believed to be non-heritable in a substantial number of people who have the disease, and that a negative test result cannot rule out the possibility that any offspring may be affected with the disease. The statement would have to include any other warnings needed to accurately convey to consumers the degree to which the test is informative for carrier status.

(iii) For prescription use tests, the following warnings that read:

(A) "The results of this test are intended to be interpreted by a board-certified clinical molecular geneticist or equivalent and should be used in conjunction with other available laboratory and clinical information."

(B) "This device is not intended for disease diagnosis, prenatal testing of fetuses, risk assessment, prognosis or pre-symptomatic testing, susceptibility testing, or newborn screening."

(iv) For over-the-counter tests, a statement that reads "This test is not intended to diagnose a disease, or tell you anything about your risk for developing a disease in the future. On its own, this test is also not intended to tell you anything about the health of your fetus, or your newborn child's risk of developing a particular disease later on in life."

(v) For over-the-counter tests, the following warnings that read:

(A) "This test is not a substitute for visits to a healthcare provider. It is recommended that you consult with a healthcare provider if you have any

questions or concerns about your results.”

(B) “The test does not diagnose any health conditions. Results should be used along with other clinical information for any medical purposes.”

(C) “The laboratory may not be able to process your sample. The probability that the laboratory cannot process your saliva sample can be up to [actual probability percentage].”

(D) “Your ethnicity may affect how your genetic health results are interpreted.”

(vi) For a positive result in an over-the-counter test when the positive predictive value for a specific population is less than 50 percent and more than 5 percent, a warning that reads “The positive result you obtained may falsely identify you as a carrier. Consider genetic counseling and followup testing.”

(vii) For a positive result in an over-the-counter test when the positive predictive value for a specific population is less than 5 percent, a warning that reads “The positive result you obtained is very likely to be incorrect due to the rarity of this variant. Consider genetic counseling and followup testing.”

(5) The testing done to comply with paragraph (b)(3) of this section must show the device meets or exceeds each of the following performance specifications:

(i) The accuracy must be shown to be equal to or greater than 99 percent for both PPA and NPA. Variants that have a point estimate for PPA or NPA of less than 99 percent (incorrect test results as compared to bidirectional sequencing or other methods identified as appropriate by FDA) must not be incorporated into test claims and reports.

(ii) Precision (reproducibility) performance must meet or exceed 99 percent for both positive and negative results.

(iii) The user comprehension study must obtain values of 90 percent or greater user comprehension for each comprehension concept.

(6) The distribution of this device, excluding the collection device described in paragraph (b)(2) of this section, shall be limited to the manufacturer, the manufacturer’s subsidiaries, and lab-

oratories regulated under the Clinical Laboratory Improvement Amendments.

[80 FR 65630, Oct. 27, 2015, as amended at 82 FR 51570, Nov. 7, 2017]

**§ 866.5950 Genetic health risk assessment system.**

(a) *Identification.* A genetic health risk assessment system is a qualitative in vitro molecular diagnostic system used for detecting variants in genomic deoxyribonucleic acid (DNA) isolated from human specimens that will provide information to users about their genetic risk of developing a disease to inform lifestyle choices and/or conversations with a health care professional. This assessment system is for over-the-counter use. This device does not determine the person’s overall risk of developing a disease.

(b) *Classification.* Class II (special controls). The genetic health risk assessment system device, when it has previously received a first-time FDA marketing authorization (*e.g.*, 510(k) clearance) for the genetic health risk assessment system (a “one-time FDA reviewed genetic health risk assessment system”), is exempt from the premarket notification procedures in part 807, subpart E, of this chapter subject to the limitations in § 866.9. The device must comply with the following special controls:

(1) The 21 CFR 809.10 compliant labeling and any prepurchase page and test report generated, unless otherwise specified, must include:

(i) A section addressed to users with the following information:

(A) The limiting statement explaining that this test provides genetic risk information based on assessment of specific genetic variants but does not report on a user’s entire genetic profile. This test [does not/may not, as appropriate] detect all genetic variants related to a given disease, and the absence of a variant tested does not rule out the presence of other genetic variants that may be related to the disease.

(B) The limiting statement explaining that other companies offering a genetic risk test may be detecting different genetic variants for the same disease, so the user may get different

results using a test from a different company.

(C) The limiting statement explaining that other factors such as environmental and lifestyle risk factors may affect the risk of developing a given disease.

(D) The limiting statement explaining that some people may feel anxious about getting genetic test health results. This is normal. If the potential user feels very anxious, such user should speak to his or her doctor or other health care professional prior to collection of a sample for testing. This test is not a substitute for visits to a doctor or other health care professional. Users should consult with their doctor or other health care professional if they have any questions or concerns about the results of their test or their current state of health.

(E) Information about how to obtain access to a genetic counselor, board-certified clinical molecular geneticist, or equivalent health care professional about the results of a user's test.

(F) The limiting statement explaining that this test is not intended to diagnose a disease, tell you anything about your current state of health, or be used to make medical decisions, including whether or not you should take a medication or how much of a medication you should take.

(G) A limiting statement explaining that the laboratory may not be able to process a sample, and a description of the next steps to be taken by the manufacturer and/or the customer, as applicable.

(ii) A section in your 21 CFR 809.10 labeling and any test report generated that is for health care professionals who may receive the test results from their patients with the following information:

(A) The limiting statement explaining that this test is not intended to diagnose a disease, determine medical treatment, or tell the user anything about their current state of health.

(B) The limiting statement explaining that this test is intended to provide users with their genetic information to inform lifestyle decisions and conversations with their doctor or other health care professional.

(C) The limiting statement explaining that any diagnostic or treatment decisions should be based on testing and/or other information that you determine to be appropriate for your patient.

(2) The genetic test must use a sample collection device that is FDA-cleared, -approved, or -classified as 510(k) exempt, with an indication for in vitro diagnostic use in over-the-counter DNA testing.

(3) The device's labeling must include a hyperlink to the manufacturer's public Web site where the manufacturer shall make the information identified in paragraph (b)(3) of this section publicly available. The manufacturer's home page, as well as the primary part of the manufacturer's Web site that discusses the device, must provide a hyperlink to the Web page containing this information and must allow unrestricted viewing access. If the device can be purchased from the Web site or testing using the device can be ordered from the Web site, the same information must be found on the Web page for ordering the device or provided in a publicly accessible hyperlink on the Web page for ordering the device. Any changes to the device that could significantly affect safety or effectiveness would require new data or information in support of such changes, which would also have to be posted on the manufacturer's Web site. The information must include:

(i) An index of the material being provided to meet the requirements in paragraph (b)(3) of this section and its location.

(ii) A section that highlights summary information that allows the user to understand how the test works and how to interpret the results of the test. This section must, at a minimum, be written in plain language understandable to a lay user and include:

(A) Consistent explanations of the risk of disease associated with all variants included in the test. If there are different categories of risk, the manufacturer must provide literature references that support the different risk categories. If there will be multiple test reports and multiple variants, the risk categories must be

defined similarly among them. For example, “increased risk” must be defined similarly between different test reports and different variant combinations.

(B) Clear context for the user to understand the context in which the cited clinical performance data support the risk reported. This includes, but is not limited to, any risks that are influenced by ethnicity, age, gender, environment, and lifestyle choices.

(C) Materials that explain the main concepts and terminology used in the test that include:

(1) *Definitions*: Scientific terms that are used in the test reports.

(2) *Prepurchase page*: This page must contain information that informs the user about what information the test will provide. This includes, but is not limited to, variant information, the condition or disease associated with the variant(s), professional guideline recommendations for general genetic risk testing, the limitations associated with the test (*e.g.*, test does not detect all variants related to the disease) and any precautionary information about the test the user should be aware of before purchase. When the test reports the risk of a life-threatening or irreversibly debilitating disease or condition for which there are few or no options to prevent, treat, or cure the disease, a user opt-in section must be provided. This opt-in page must be provided for each disease that falls into this category and must provide specific information relevant to each test result. The opt-in page must include:

(i) An option to accept or decline to receive this specific test result;

(ii) Specification of the risk involved if the user is found to have the specific genetic test result;

(iii) Professional guidelines that recommend when genetic testing for the associated target condition is or is not recommended; and

(iv) A recommendation to speak with a health care professional, genetic counselor, or equivalent professional before getting the results of the test.

(3) *Frequently asked questions (FAQ) page*: This page must provide information that is specific for each variant/disease pair that is reported. Information provided in this section must be

scientifically valid and supported by corresponding publications. The FAQ page must explain the health condition/disease being tested, the purpose of the test, the information the test will and will not provide, the relevance of race and ethnicity to the test results, information about the population to which the variants in the test is most applicable, the meaning of the result(s), other risk factors that contribute to disease, appropriate followup procedures, how the results of the test may affect the user’s family, including children, and links to resources that provide additional information.

(iii) A technical information section containing the following information:

(A) Gene(s) and variant(s) the test detects using standardized nomenclature, Human Genome Organization nomenclature and coordinates as well as Single Nucleotide Polymorphism Database (dbSNP) reference SNP numbers (rs#).

(B) Scientifically established disease-risk association of each variant detected and reported by the test. This risk association information must include:

(1) Genotype-phenotype information for the reported variants.

(2) Table of expected frequency and risks of developing the disease in relevant ethnic populations and the general population.

(3) A statement about the current professional guidelines for testing these specific gene(s) and variant(s).

(i) If professional guidelines are available, provide the recommendations in the professional guideline for the gene, variant, and disease, for when genetic testing should or should not be performed, and cautionary information that should be communicated when a particular gene and variant is detected.

(ii) If professional guidelines are not available, provide a statement that the professional guidelines are not available for these specific gene(s) and variant(s).

(C) The specimen type (*e.g.*, saliva, capillary whole blood).

(D) Assay steps and technology used.

(E) Specification of required ancillary reagents, instrumentation, and equipment.

(F) Specification of the specimen collection, processing, storage, and preparation methods.

(G) Specification of risk mitigation elements and description of all additional procedures, methods, and practices incorporated into the directions for use that mitigate risks associated with testing.

(H) Information pertaining to the probability of test failure (*i.e.*, percentage of tests that failed quality control) based on data from clinical samples, a description of scenarios in which a test can fail (*i.e.*, low sample volume, low DNA concentration, etc.), how users will be notified of a test failure, and the nature of followup actions on a failed test to be taken by the user and the manufacturer.

(I) Specification of the criteria for test result interpretation and reporting.

(J) Information that demonstrates the performance characteristics of the test, including:

(1) Accuracy of study results for each claimed specimen type.

(i) Accuracy of the test shall be evaluated with fresh clinical specimens collected and processed in a manner consistent with the test's instructions for use. If this is impractical, fresh clinical samples may be substituted or supplemented with archived clinical samples. Archived samples shall have been collected previously in accordance with the instructions for use, stored appropriately, and randomly selected. In some limited circumstances, use of contrived samples or human cell line samples may also be appropriate and used as an acceptable alternative. The contrived or human cell line samples shall mimic clinical specimens as much as is feasible and provide an unbiased evaluation of the device accuracy.

(ii) Accuracy must be evaluated by comparison to bidirectional Sanger sequencing or other methods identified as appropriate by FDA. Performance criteria for both the comparator method and the device must be predefined and appropriate to the device's intended use. Detailed study protocols must be provided.

(iii) Test specimens must include all genotypes that will be included in the

tests and reports. The number of samples tested in the accuracy study for each variant reported must be based on the variant frequency using either the minimum numbers of samples identified in this paragraph or, when determined appropriate and identified by FDA, a minimum number of samples determined using an alternative method. When appropriate, the same samples may be used in testing to demonstrate the accuracy of testing for multiple genotypes by generating sequence information at multiple relevant genetic locations. At least 20 unique samples representing the wild-type genotype must be tested. To test samples that are heterozygous for the reported variant(s), common variants (>0.1 percent variant frequency in the relevant population) must be tested with at least 20 unique samples. Rare variants ( $\leq 0.1$  percent variant frequency in the relevant population) must be tested with at least three unique samples. To test samples that are homozygous for the reported variant(s), variants with  $\geq 2$  percent variant frequency in a relevant population must be tested with at least 20 unique samples. Variants with a frequency in the relevant population <2 percent and  $\geq 0.5$  percent must be tested with at least 10 unique samples. Variants with a frequency in the relevant population <0.5 percent must be tested with at least three unique samples. If variants with a frequency of <0.5 percent are not found within the relevant population and homozygous samples are not tested, then the test results for this homozygous rare variant must not be reported to the user.

(iv) Information about the accuracy study shall include the number and type of samples that were compared to bidirectional Sanger sequencing or other methods identified as appropriate by FDA. This information must either be reported in tabular format and arranged by clinically relevant variants or reported using another method identified as appropriate by FDA. As an example, for samples with different genotypes DD, Dd, and dd, the following table represents data from the accuracy study presented in tabular format:



		Comparator		
		DD	Dd	dd
Device	DD	A <sub>1</sub>	B <sub>1</sub>	C <sub>1</sub>
	Dd	A <sub>2</sub>	B <sub>2</sub>	C <sub>2</sub>
	dd	A <sub>3</sub>	B <sub>3</sub>	C <sub>3</sub>
	no calls or invalid	A <sub>4</sub>	B <sub>4</sub>	C <sub>4</sub>
Total		N <sub>DD</sub>	N <sub>Dd</sub>	N <sub>dd</sub>

where:

D and d = Variants; d = Risk variant;

A<sub>1</sub>, A<sub>2</sub>, A<sub>3</sub>, A<sub>4</sub> are numbers of samples with DD result by the comparator and DD, Dd, dd, or ‘no calls’ or ‘invalid’ results by the device correspondingly and N<sub>DD</sub> is the total number of samples with DD result by the comparator (N<sub>DD</sub>=A<sub>1</sub>+A<sub>2</sub>+A<sub>3</sub>+A<sub>4</sub>);

B<sub>1</sub>, B<sub>2</sub>, B<sub>3</sub>, B<sub>4</sub> are numbers of samples with Dd result by the comparator and DD, Dd, dd, or ‘no calls’ or ‘invalid’ results by the device correspondingly and N<sub>Dd</sub> is the total number of samples with Dd result by the comparator (N<sub>Dd</sub>=B<sub>1</sub>+B<sub>2</sub>+B<sub>3</sub>+B<sub>4</sub>);

C<sub>1</sub>, C<sub>2</sub>, C<sub>3</sub>, C<sub>4</sub> are numbers of samples with dd result by the comparator and DD, Dd, dd, or ‘no calls’ or ‘invalid’ results by the device correspondingly and N<sub>dd</sub> is the total number of samples with dd result by the comparator (N<sub>dd</sub>=C<sub>1</sub>+C<sub>2</sub>+C<sub>3</sub>+C<sub>4</sub>);

(v) The accuracy represents the degrees of agreement between the device results and the comparator results. The accuracy must be evaluated by measuring different percent agreements (PA) of device results with the comparator results and percent of ‘no calls’ or ‘invalid calls.’ Calculate the rate of ‘no calls’ and ‘invalid calls’ for each comparator output as %Inv(DD) = A<sub>4</sub>/N<sub>DD</sub>, %Inv(Dd) = B<sub>4</sub>/N<sub>Dd</sub>, %Inv(dd) = C<sub>4</sub>/N<sub>dd</sub>. If ‘no calls’ or ‘invalid calls’ are required to be retested according to the device instructions for use, the percent of final ‘no calls’ or ‘invalid calls’ must be provided. In the table presenting the results of the accuracy study, use only the final results (*i.e.*, after retesting the initial ‘no calls’ or ‘invalid calls’, if required according to the instructions

for use). Samples that resulted in a ‘no call’ or ‘invalid call’ after retesting must not be included in the final calculations of agreement. If the percentages of ‘no calls’ or ‘invalid calls’ for each comparator output are similar, combine these estimates as (A<sub>4</sub> + B<sub>4</sub> + C<sub>4</sub>)/(N<sub>DD</sub> + N<sub>Dd</sub> + N<sub>dd</sub>) and provide a 95 percent two-sided confidence interval. The percent of final ‘no calls’ or ‘invalid calls’ must be clinically acceptable.

(vi) Point estimates of percent agreement for each genotype must be calculated as the number of correct calls for that genotype divided by the number of samples known to contain that genotype excluding ‘no calls’ or ‘invalid calls’. The calculations must be performed as follows:

$$PA(DD|DD)=A_1/(A_1+A_2+A_3);$$

$$PA(Dd|DD)=A_2/(A_1+A_2+A_3); \text{ and } PA(dd|DD)=1-PA(DD|DD)-PA(Dd|DD).$$

$$PA(Dd|Dd)=B_2/(B_1+B_2+B_3);$$

$$PA(DD|Dd)=B_1/(B_1+B_2+B_3); \text{ and } PA(dd|Dd)=1-PA(DD|Dd)-PA(Dd|Dd).$$

$$PA(dd|dd)=C_3/(C_1+C_2+C_3);$$

$$PA(Dd|dd)=C_2/(C_1+C_2+C_3) \text{ and } PA(DD|dd)=1-P(Dd|dd)-PA(dd|dd).$$

(vii) For percent agreements for DD, Dd and dd (PA(DD|DD), PA(Dd|Dd) and PA(dd|dd)) as described in paragraph (b)(3)(iii)(J)(I)(vi) of this section, the 95 percent two-sided confidence intervals must be provided. The accuracy point estimates for percent agreements for DD, Dd and dd must be  $\geq 99$  percent per reported variant and overall. Any variants that have a point estimate for either PA(DD|DD), PA(Dd|Dd), or PA(dd|dd) of  $< 99$  percent compared to bidirectional sequencing or other methods identified as appropriate by FDA must not be incorporated into test claims and reports. Accuracy results generated from clinical specimens versus contrived samples or cell lines must be presented separately. Results must be summarized and presented in tabular format by sample type and by genotype or must be reported using another method identified as appropriate by FDA (see paragraph (b)(3)(iii)(J)(I)(iv) of this section).

(viii) Information must be reported on the Technical Positive Predictive Value (TPPV) related to the analytical (technical) performance of the device for genotypes in each relevant subpopulation (e.g., ethnicity, gender, age, geographical location, etc.). TPPV is the percentage of individuals with the genotype truly present among individuals whose test reports indicate that this genotype is present. The TPPV de-

pends on the accuracy measures of percent agreements and on the frequency of the genotypes in the subpopulation being studied. The  $f(DD)$  is the frequency of DD and  $f(Dd)$  is the frequency of Dd in the subpopulation being studied; TPPV must be calculated as described in paragraphs (b)(3)(iii)(J)(I)(ix) through (xi) of this section.

(ix) For variants where the point estimates of PA(DD|DD), PA(Dd|Dd) and PA(dd|dd) are less than 100 percent, use these point estimates in TPPV calculations.

(x) Point estimates of 100 percent in the accuracy study may have high uncertainty about performance of the test in the population. If these variants are measured using highly multiplexed technology, calculate the random error rate for the overall device. The accuracy study described in paragraph (b)(3)(iii)(J) of this section in those cases is more to determine that there is no systematic error in such devices. In those cases, incorporate that rate in the estimation of the percent agreements as calculated in paragraph (b)(3)(iii)(J)(I)(vi) of this section and include it in TPPV calculations.

(xi) The TPPV for subpopulations with genotype frequencies of  $f(dd)$ ,  $f(Dd)$  and  $f(DD) = 1 - f(dd) - f(Dd)$  in the subpopulation is calculated as:

The TPPV for subpopulations with genotype frequencies of  $f(dd)$ ,  $f(Dd)$  and  $f(DD)=1-f(dd)-f(Dd)$  in the subpopulation is calculated as:

$$\text{TPPV for a device result of } dd = \frac{[PA(dd|dd) \cdot f(dd)]}{[PA(dd|dd) \cdot f(dd) + PA(dd|Dd) \cdot f(Dd) + PA(dd|DD) \cdot f(DD)]}$$

$$\text{TPPV for a device result of } Dd = \frac{[PA(Dd|Dd) \cdot f(Dd)]}{[PA(Dd|DD) \cdot f(DD) + PA(Dd|Dd) \cdot f(Dd) + PA(Dd|dd) \cdot f(dd)]}$$

(2) Precision and reproducibility data must be provided using multiple instruments and multiple operators, on multiple non-consecutive days, and using multiple reagent lots. The sample panel must either include specimens from the claimed sample type (*e.g.*, saliva) representing all genotypes for each variant (*e.g.*, wild type, heterozygous, and homozygous) or, if an alternative panel composition of specimens is identified by FDA as appropriate, a panel composed of those specimens FDA identified as appropriate. A detailed study protocol must be created in advance of the study and must include predetermined acceptance criteria for performance results. The percentage of samples that failed quality control must be indicated (*i.e.*, the total number of sample replicates for which a sequence variant cannot be called (no calls) or that fail sequencing quality control criteria divided by the total number of replicates tested). It must be clearly documented whether results were generated from clinical specimens, contrived samples, or cell lines. The study results shall report the variants tested in the study and the number of replicates for each variant, and what conditions were tested (*i.e.*, number of runs, days, instruments, reagent lots, operators, specimens/type, etc.). Results must be evaluated and presented in tabular format and stratified by study parameter (*e.g.*, by site, instrument(s), reagent lot, operator, and sample variant). The study must include all extraction steps from

the claimed specimen type or matrix, unless a separate extraction reproducibility study for the claimed sample type is performed. If the device is to be used at more than one laboratory, different laboratories must be included in the reproducibility study and reproducibility across sites must be evaluated. Any no calls or invalid calls in the study must be listed as a part of the precision and reproducibility study results.

(3) *Analytical specificity data*: Data must be provided that evaluates the effect of potential endogenous and exogenous interferences on test performance, including specimen extraction and variant detection. Interferents tested must include those reasonably likely to be potentially relevant to the sample type used for the device.

(4) *Interfering variant data*: Nucleotide mutations that can interfere with the technology must be cited and evaluated. Data must be provided to demonstrate the effect of the interfering variant(s) on the performance of the correct calls. Alternatively, for each suspected interfering mutation for which data is not provided demonstrating the effect of the interfering variant, the manufacturer must identify the suspected interfering variants in the labeling and indicate that the impact that the interfering variants may have on the assay's performance has not been studied by providing a statement that reads "It is possible that the presence of [insert clearly

identifying information for the suspected interfering variant] in a sample may interfere with the performance of this test. However, its effect on the performance of this test has not been studied.”

(5) *Analytical sensitivity data:* Data must be provided demonstrating the minimum amount of DNA that will enable the test to perform correctly in 95 percent of runs.

(6) *Reagent stability:* The manufacturer must evaluate reagent stability using wild-type, heterozygous, and homozygous samples. Reagent stability data must demonstrate that the reagents maintain the claimed accuracy and reproducibility. Data supporting such claims must be provided.

(7) *Specimen type and matrix comparison data:* Specimen type and matrix comparison data must be generated if more than one specimen type can be tested with this device, including failure rates for the different specimens.

(K) Clinical performance summary.

(1) Information to support the clinical performance of each variant reported by the test must be provided.

(2) Manufacturers must organize information by the specific variant combination as appropriate (*e.g.*, wild type, heterozygous, homozygous, compound heterozygous, hemizygous genotypes). For each variant combination, information must be provided in the clinical performance section to support clinical performance for the risk category (*e.g.*, not at risk, increased risk). For each variant combination, a summary of key results must be provided in tabular format or using another method identified as appropriate by FDA to include the appropriate information regarding variant type, data source, definition of the target condition (*e.g.*, disease), clinical criteria for determining whether the target disease is present or absent, description of subjects with the target disease present and target disease absent (exclusion or inclusion criteria), and technical method for genotyping. When available, information on the effect of the variant on risk must be provided as the risk of a disease (lifetime risk or lifetime incidences) for an individual compared with the general population risk.

(i) If odds ratios are available, using information about the genotype distribution either among individuals with the target disease absent, or in the general population, or information about the risk variant frequency and odds ratios, the likelihood ratios for the corresponding device results along with 95 percent confidence intervals must be calculated. Using information about pretest risk ( $\pi$ ), an estimate of likelihood ratio (LR), and a relationship between post-test risk  $R$  as  $R/(1-R) = LR \cdot \pi/(1-\pi)$ , the post-test risk  $R$  must be calculated.

(ii) When available, likelihood ratios (LR) for different test results must be presented in a tabular format along with references to the source data or using another method identified as appropriate by FDA as stated in paragraph (b)(3)(iii)(K)(2) of this section. When these values are not directly available in published literature, likelihood ratios can be separately calculated along with the 95 percent confidence interval with references to the source data. Note that a minimum requirement for the presence of the variant's effect on the risk is that a corresponding LR is statistically higher than 1 (a lower bound of 95 percent two-sided confidence interval is larger than 1). It means that the post-test risk is statistically higher than the pretest risk (an observed value of the difference between the post-test and pretest risks).

(L) Materials that explain the main concepts and terminology used in the test that includes, but is not limited to:

(1) *Definitions:* Scientific terms that are used in the test reports.

(2) *Prepurchase page:* This page must contain information that informs the user about what the test will provide. This includes, but is not limited to, variant information, the condition or disease associated with the variant(s), professional guideline recommendations for general genetic risk testing, the limitations associated with the test (*e.g.*, test does not detect all variants related to the disease) and any precautionary information about the test the user should be aware of before purchase. When the test reports the

risk of a life-threatening or irreversibly debilitating disease or condition for which there are few or no options to prevent, treat, or cure the disease, a user opt-in section must be provided. This opt-in page must be provided for each disease that falls into this category and must provide specific information relevant to each test result. The opt-in page must include:

(i) An option to accept or decline to receive this specific test result;

(ii) Specification of the risk involved if the user is found to have the specific genetic test result;

(iii) Professional guidelines that recommend when genetic testing for the associated target condition is or is not recommended; and

(iv) A recommendation to speak with a health care professional, genetic counselor, or equivalent professional before getting the results of the test.

(3) Frequently asked questions (FAQ) page: This page must provide information that is specific for each variant/disease pair that is reported. Information provided in this section must be scientifically valid and supported by corresponding publications. The FAQ page must explain the health condition/disease being tested, the purpose of the test, the information the test will and will not provide, the relevance of race and ethnicity on the test results, information about the population to which the variants in the test is most applicable, the meaning of the result(s), other risks factors that contribute to disease, appropriate followup procedures, how the results of the test may affect the user's family, including children, and links to resources that provide additional information.

(M) User comprehension study: Information on a study that assesses comprehension of the test process and results by potential users of the test must be provided.

(I) The test manufacturer must provide a genetic risk education module to naïve user comprehension study participants prior to their participation in the user comprehension study. The module must define terms that are used in the test reports and explain the significance of genetic risk reports.

(2) The test manufacturer must perform pre- and post-test user com-

prehension studies. The comprehension test questions must include directly evaluating a representative sample of the material being presented to the user as described in paragraph (b)(3)(ii) of this section.

(3) The manufacturer must provide a justification from a physician and/or genetic counselor that identifies the appropriate general and variant-specific concepts contained within the material being tested in the user comprehension study to ensure that all relevant concepts are incorporated in the study.

(4) The user study must meet the following criteria:

(i) The study participants must comprise a statistically sufficient sample size and demographically diverse population (determined using methods such as quota-based sampling) that is representative of the intended user population. Furthermore, the study participants must comprise a diverse range of age and educational levels and have no prior experience with the test or its manufacturer. These factors shall be well defined in the inclusion and exclusion criteria.

(ii) All sources of bias must be predefined and accounted for in the study results with regard to both responders and non-responders.

(iii) The testing must follow a format where users have limited time to complete the studies (such as an onsite survey format and a one-time visit with a cap on the maximum amount of time that a participant has to complete the tests).

(iv) Users must be randomly assigned to study arms. Test reports in the user comprehension study given to users must define the target condition being tested and related symptoms, explain the intended use and limitations of the test, explain the relevant ethnicities in regard to the variant tested, explain genetic health risks and relevance to the user's ethnicity, and assess participants' ability to understand the following comprehension concepts: The test's limitations, purpose, appropriate action, test results, and other factors that may have an impact on the test results.

(v) Study participants must be untrained, be naïve to the test subject of

**§ 866.6010**

the study, and be provided the labeling prior to the start of the user comprehension study.

(vi) The user comprehension study must meet the predefined primary endpoint criteria, including a minimum of a 90 percent or greater overall comprehension rate (*i.e.*, selection of the correct answer) for each comprehension concept. Other acceptance criteria may be acceptable depending on the concept being tested. Meeting or exceeding this overall comprehension rate demonstrates that the materials presented to the user are adequate for over-the-counter use.

(vii) The analysis of the user comprehension results must include results regarding reports that are provided for each gene/variant/ethnicity tested, statistical methods used to analyze all data sets, and completion rate, non-responder rate, and reasons for non-response/data exclusion. A summary table of comprehension rates regarding comprehension concepts (*e.g.*, purpose of test, test results, test limitations, ethnicity relevance for the test results, etc.) for each study report must be included.

(4) The intended use of the device must not include the following indications for use:

- (i) Prenatal testing;
- (ii) Determining predisposition for cancer where the result of the test may lead to prophylactic screening, confirmatory procedures, or treatments that may incur morbidity or mortality to the patient;
- (iii) Assessing the presence of genetic variants that impact the metabolism, exposure, response, risk of adverse events, dosing, or mechanisms of prescription or over-the-counter medications; or
- (iv) Assessing the presence of deterministic autosomal dominant variants.

[82 FR 51561, Nov. 7, 2017, as amended at 83 FR 25914, June 5, 2018]

**21 CFR Ch. I (4–1–20 Edition)**

**Subpart G—Tumor Associated Antigen Immunological Test Systems**

**§ 866.6010 Tumor-associated antigen immunological test system.**

(a) *Identification.* A tumor-associated antigen immunological test system is a device that consists of reagents used to qualitatively or quantitatively measure, by immunochemical techniques, tumor-associated antigens in serum, plasma, urine, or other body fluids. This device is intended as an aid in monitoring patients for disease progress or response to therapy or for the detection of recurrent or residual disease.

(b) *Classification.* Class II (special controls). Tumor markers must comply with the following special controls: (1) A guidance document entitled “Guidance Document for the Submission of Tumor Associated Antigen Premarket Notifications (510(k)s) to FDA,” and (2) voluntary assay performance standards issued by the National Committee on Clinical Laboratory Standards.

[62 FR 66005, Dec. 17, 1997]

**§ 866.6020 Immunomagnetic circulating cancer cell selection and enumeration system.**

(a) *Identification.* An immunomagnetic circulating cancer cell selection and enumeration system is a device that consists of biological probes, fluorochromes, and other reagents; preservation and preparation devices; and a semiautomated analytical instrument to select and count circulating cancer cells in a prepared sample of whole blood. This device is intended for adjunctive use in monitoring or predicting cancer disease progression, response to therapy, and for the detection of recurrent disease.

(b) *Classification.* Class II (special controls). The special control for this device is FDA’s guidance document entitled “Class II Special Controls Guidance Document: Immunomagnetic Circulating Cancer Cell Selection and Enumeration System.” See § 866.1(e) for availability of this guidance document.

[69 FR 26033, May 11, 2004]

**§ 866.6030 AFP-L3% immunological test system.**

(a) *Identification.* An AFP-L3% immunological test system is an in vitro device that consists of reagents and an automated instrument used to quantitatively measure, by immunochemical techniques, AFP and AFP-L3 subfraction in human serum. The device is intended for in vitro diagnostic use as an aid in the risk assessment of patients with chronic liver disease for development of hepatocellular carcinoma, in conjunction with other laboratory findings, imaging studies, and clinical assessment.

(b) *Classification.* Class II (special controls). The special control is FDA's guidance document entitled "Class II Special Controls Guidance Document: AFP-L3% Immunological Test Systems." See § 866.1(e) for the availability of this guidance document.

[70 FR 57749, Oct. 4, 2005]

**§ 866.6040 Gene expression profiling test system for breast cancer prognosis.**

(a) *Identification.* A gene expression profiling test system for breast cancer prognosis is a device that measures the ribonucleic acid (RNA) expression level of multiple genes and combines this information to yield a signature (pattern or classifier or index) to aid in prognosis of previously diagnosed breast cancer.

(b) *Classification.* Class II (special controls). The special control is FDA's guidance document entitled "Class II

Special Controls Guidance Document: Gene Expression Profiling Test System for Breast Cancer Prognosis." See § 866.1(e) for the availability of this guidance document.

[72 FR 26291, May 9, 2007]

**§ 866.6050 Ovarian adnexal mass assessment score test system.**

(a) *Identification.* An ovarian/adnexal mass assessment test system is a device that measures one or more proteins in serum or plasma. It yields a single result for the likelihood that an adnexal pelvic mass in a woman, for whom surgery is planned, is malignant. The test is for adjunctive use, in the context of a negative primary clinical and radiological evaluation, to augment the identification of patients whose gynecologic surgery requires oncology expertise and resources.

(b) *Classification.* Class II (special controls). The special control for this device is FDA's guidance document entitled "Class II Special Controls Guidance Document: Ovarian Adnexal Mass Assessment Score Test System." For the availability of this guidance document, see § 866.1(e).

(c) *Black box warning.* Under section 520(e) of the Federal Food, Drug, and Cosmetic Act these devices are subject to the following restriction: A warning statement must be placed in a black box and must appear in all advertising, labeling, and promotional material for these devices. That warning statement must read:

PRECAUTION: The [test name] should not be used without an independent clinical/radiological evaluation and is **not** intended to be a screening test or to determine whether a patient should proceed to surgery. Incorrect use of the [test name] carries the risk of unnecessary testing, surgery, and/or delayed diagnosis.

[76 FR 16294, Mar. 23, 2011, as amended at 76 FR 82131, Dec. 30, 2011]

**§ 866.6060 BCR-ABL quantitation test.**

(a) *Identification.* A BCR-ABL quantitation test is identified as a reverse transcription-quantitative polymerase chain reaction (RT-qPCR) test for the quantitation of BCR-ABL1 expressed on the International Scale (IS) and control transcripts in total RNA from whole blood of diagnosed t(9;22) positive chronic myeloid leukemia (CML) patients during monitoring of treatment with tyrosine kinase inhibitors. This test is not intended for the diagnosis of CML.

(b) *Classification.* Class II (special controls). The special controls for this device are:

(1) Premarket notification submissions must include the following information:

(i) The indication for use must indicate the variant(s) for which the assay was designed and validated, for example BCR-ABL e13a2 and/or e14a2.

(ii) A detailed description of all components in the test, including the following:

(A) A detailed description of the test components, all required reagents, instrumentation and equipment, including illustrations or photographs of non-standard equipment or methods;

(B) Detailed documentation of the device software including, but not limited to, standalone software applications and hardware-based devices that incorporate software;

(C) Methodology and protocols for control procedures for the assay to allow reporting on the International Scale;

(D) A description of the result outputs, analytical sensitivity of the assay, and the range of values that will be reported; and

(E) A description of appropriate internal and external controls that are recommended or provided. The description must identify those control elements that are incorporated into the testing procedure.

(iii) Information that demonstrates the performance characteristics of the test, including:

(A) For indications for use based on a threshold established in a predicate de-

vice of this generic type, device performance data from either a method comparison study to the predicate device or through a clinical study demonstrating clinical validity using well-characterized prospectively or retrospectively obtained clinical specimens, as appropriate, representative of the intended use population;

(B) For indications for use based on a threshold not established in a predicate device of this generic type, device performance data from a clinical study demonstrating clinical validity using well-characterized prospectively or retrospectively obtained clinical specimens, as appropriate, representative of the intended use population;

(C) Device reproducibility data generated, using a minimum of three sites, of which at least two sites must be external sites, with two operators at each site. Each site must conduct a minimum of three runs per operator over non-consecutive days evaluating a minimum of five different BCR-ABL concentrations that span and are well distributed over the measuring range and include MR3 (0.1 percent IS). Results shall be reported as the standard deviation and percentage coefficient of variation for each level tested. Prespecified acceptance criteria must be provided and followed;

(D) Device precision data using clinical samples to evaluate the within-lot, between-lot, within-run, between run, and total variation;

(E) Device linearity data using a dilution panel created from clinical samples;

(F) Device analytic sensitivity data, including limit of blank, limit of detection, and limit of quantification;

(G) Device specificity data, including interference and cross-contamination; and

(H) Device stability data, including real-time stability of samples under various storage times, temperatures, and freeze-thaw conditions.

(iv) Identification of risk mitigation elements used by your device, including a detailed description of all additional procedures, methods, and practices incorporated into the instructions for use that mitigate risks associated with testing using your device.



(2) Your 21 CFR 809.10 compliant labeling must include the following:

(i) The intended use in your 21 CFR 809.10(a)(2) and (b)(2) complaint labeling must include an indication for use statement that reads “This test is not intended for the diagnosis of CML”; and

(ii) A detailed description of the performance studies conducted to comply with paragraph (b)(1)(iii) of this section and a summary of the results.

(3) Your device output must include results on the International Scale (IS) and your assay must include multipoint calibration controls traceable to a relevant international reference panel (*e.g.*, the World Health Organization International Genetic Reference Panel for quantitation of BCR-ABL mRNA).

[82 FR 50532, Nov. 1, 2017]

**§ 866.6080 Next generation sequencing based tumor profiling test.**

(a) *Identification.* A next generation sequencing (NGS) based tumor profiling test is a qualitative in vitro diagnostic test intended for NGS analysis of tissue specimens from malignant solid neoplasms to detect somatic mutations in a broad panel of targeted genes to aid in the management of previously diagnosed cancer patients by qualified health care professionals.

(b) *Classification.* Class II (special controls). The special controls for this device are:

(1) Premarket notification submissions must include the following information:

(i) A detailed description of all somatic mutations that are intended to be detected by the test and that are adequately supported in accordance with paragraph (b)(1)(v) of this section and reported in the test results in accordance with paragraph (b)(2)(iv) of this section, including:

(A) A listing of mutations that are cancer mutations with evidence of clinical significance.

(B) As appropriate, a listing of mutations that are cancer mutations with potential clinical significance.

(ii) The indications for use must specify the following:

(A) The test is indicated for previously diagnosed cancer patients.

(B) The intended specimen type(s) and matrix (*e.g.*, formalin-fixed, paraffin-embedded tumor tissue).

(C) The mutation types (*e.g.*, single nucleotide variant, insertion, deletion, copy number variation or gene rearrangement) for which validation data has been provided.

(D) The name of the testing facility or facilities, as applicable.

(iii) A detailed device description including the following:

(A) A description of the test in terms of genomic coverage, as follows:

(1) Tabulated summary of all mutations reported, grouped according to gene and target region within each gene, along with the specific cDNA and amino acid positions for each mutation.

(2) A description of any within-gene targeted regions that cannot be reported and the data behind such conclusion.

(B) Specifications for specimen requirements including any specimen collection devices and preservatives, specimen volume, minimum tumor content, specimen handling, DNA extraction, and criteria for DNA quality and quantity metrics that are prerequisite to performing the assay.

(C) A detailed description of all test components, reagents, instrumentation, and software required. Detailed documentation of the device software including but not limited to, software applications and hardware-based devices that incorporate software.

(D) A detailed description of the methodology and protocols for each step of the test, including description of the quality metrics, thresholds, and filters at each step of the test that are implemented for final result reporting and a description of the metrics for run-failures, specimen-failures, invalids, as applicable.

(E) A list of links provided by the device to the user or accessed by the device for internal or external information (*e.g.*, decision rules or databases) supporting clinical significance of test results for the panel or its elements in accordance with paragraphs (b)(1)(v) and (b)(2)(vi) of this section.

(F) A description of internal and external controls that are recommended or provided and control procedures.

The description must identify those control elements that are incorporated into the testing procedure.

(iv) Information demonstrating analytical validity of the device according to analytical performance characteristics, evaluated either specifically for each gene/mutation or, when clinically and practically justified, using a representative approach based on other mutations of the same type, including:

(A) Data that adequately supports the intended specimen type (*e.g.*, formalin-fixed, paraffin-embedded tumor tissue), specimen handling protocol, and nucleic acid purification for specific tumor types or for a pan-tumor claim.

(B) A summary of the empirical evidence obtained to demonstrate how the analytical quality metrics and thresholds were optimized.

(C) Device precision data using clinical samples to adequately evaluate intra-run, inter-run, and total variability. The samples must cover all mutation types tested (both positive and negative samples) and include samples near the limit of detection of the device. Precision must be assessed by agreement within replicates on the assay final result for each representative mutation, as applicable, and also supported by sequencing quality metrics for targeted regions across the panel.

(D) Description of the protocols and/or data adequately demonstrating the interchangeability of reagent lots and multiplexing barcodes.

(E) A description of the nucleic acid assay input concentration range and the evidence to adequately support the range.

(F) A description of the data adequately supporting the limit of detection of the device.

(G) A description of the data to adequately support device accuracy using clinical specimens representing the intended specimen type and range of tumor types, as applicable.

(I) Clinical specimens tested to support device accuracy must adequately represent the list of cancer mutations with evidence of clinical significance to be detected by the device.

(2) For mutations that are designated as cancer mutations with evidence of

clinical significance and that are based on evidence established in the intended specimen type (*e.g.*, tumor tissues) but for a different analyte type (*e.g.*, protein, RNA) and/or a measurement (*e.g.*, incorporating a score or copy number) and/or with an alternative technology (*e.g.*, IHC, RT-qPCR, FISH), evidence of accuracy must include clinically adequate concordance between results for the mutation and the medically established biomarker test (*e.g.*, evidence generated from an appropriately sized method comparison study using clinical specimens from the target population).

(3) For qualitative DNA mutations not described in paragraph (b)(1)(iv)(G)(2) of this section, accuracy studies must include both mutation-positive and wild-type results.

(H) Adequate device stability information.

(v) Information that adequately supports the clinical significance of the panel must include:

(A) Criteria established on what types and levels of evidence will clinically validate a mutation as a cancer mutation with evidence of clinical significance versus a cancer mutation with potential clinical significance.

(B) For representative mutations of those designated as cancer mutations with evidence of clinical significance, a description of the clinical evidence associated with such mutations, such as clinical evidence presented in professional guidelines, as appropriate, with method comparison performance data as described in paragraph (b)(1)(iv)(G) of this section.

(C) For all other mutations designated as cancer mutations with potential clinical significance, a description of the rationale for reporting.

(2) The 21 CFR 809.10 compliant labeling and any product information and test report generated, must include the following, as applicable:

(i) The intended use statement must specify the following:

(A) The test is indicated for previously diagnosed cancer patients.

(B) The intended specimen type(s) and matrix (*e.g.*, formalin-fixed, paraffin-embedded tumor tissue).

(C) The mutation types (*e.g.*, single nucleotide variant, insertion, deletion,

copy number variation or gene rearrangement) for which validation data has been provided.

(D) The name of the testing facility or facilities, as applicable.

(ii) A description of the device and summary of the results of the performance studies performed in accordance with paragraphs (b)(1)(iii), (b)(1)(iv), and (b)(1)(v) of this section.

(iii) A description of applicable test limitations, including, for device specific mutations validated with method comparison data to a medically established test in the same intended specimen type, appropriate description of the level of evidence and/or the differences between next generation sequencing results and results from the medically established test (*e.g.*, as described in professional guidelines).

(iv) A listing of all somatic mutations that are intended to be detected by the device and that are reported in the test results under the following two categories or equivalent designations, as appropriate: “cancer mutations panel with evidence of clinical significance” or “cancer mutations panel with potential clinical significance.”

(v) For mutations reported under the category of “cancer mutations panel with potential clinical significance,” a limiting statement that states “For the mutations listed in [cancer mutations panel with potential clinical significance or equivalent designation], the clinical significance has not been demonstrated [with adequate clinical evidence (*e.g.*, by professional guidelines) in accordance with paragraph (b)(1)(v) of this section] or with this test.”

(vi) For mutations under the category of “cancer mutations panel with evidence of clinical significance,” or equivalent designation, link(s) for physicians to access internal or external information concerning decision rules or conclusions about the level of evidence for clinical significance that is associated with the marker in accordance with paragraph (b)(1)(v) of this section.

[83 FR 28995, June 22, 2018]

## PART 868—ANESTHESIOLOGY DEVICES

### Subpart A—General Provisions

Sec.

- 868.1 Scope.
- 868.3 Effective dates of requirement for pre-market approval.
- 868.9 Limitations of exemptions from section 510(k) of the Federal Food, Drug, and Cosmetic Act (the act).

### Subpart B—Diagnostic Devices

- 868.1030 Manual algesimeter.
- 868.1040 Powered algesimeter.
- 868.1075 Argon gas analyzer.
- 868.1100 Arterial blood sampling kit.
- 868.1120 Indwelling blood oxyhemoglobin concentration analyzer.
- 868.1150 Indwelling blood carbon dioxide partial pressure (P<sub>CO<sub>2</sub></sub>) analyzer.
- 868.1170 Indwelling blood hydrogen ion concentration (pH) analyzer.
- 868.1200 Indwelling blood oxygen partial pressure (P<sub>O<sub>2</sub></sub>) analyzer.
- 868.1400 Carbon dioxide gas analyzer.
- 868.1430 Carbon monoxide gas analyzer.
- 868.1500 Enflurane gas analyzer.
- 868.1505 Ventilatory electrical impedance tomograph.
- 868.1575 Gas collection vessel.
- 868.1620 Halothane gas analyzer.
- 868.1640 Helium gas analyzer.
- 868.1670 Neon gas analyzer.
- 868.1690 Nitrogen gas analyzer.
- 868.1700 Nitrous oxide gas analyzer.
- 868.1720 Oxygen gas analyzer.
- 868.1730 Oxygen uptake computer.
- 868.1750 Pressure plethysmograph.
- 868.1760 Volume plethysmograph.
- 868.1780 Inspiratory airway pressure meter.
- 868.1800 Rhinoanemometer.
- 868.1840 Diagnostic spirometer.
- 868.1850 Monitoring spirometer.
- 868.1860 Peak-flow meter for spirometry.
- 868.1870 Gas volume calibrator.
- 868.1880 Pulmonary-function data calculator.
- 868.1890 Predictive pulmonary-function value calculator.
- 868.1900 Diagnostic pulmonary-function interpretation calculator.
- 868.1910 Esophageal stethoscope.
- 868.1920 Esophageal stethoscope with electrical conductors.
- 868.1930 Stethoscope head.
- 868.1965 Switching valve (ploss).
- 868.1975 Water vapor analyzer.

### Subpart C—Monitoring Devices

- 868.2025 Ultrasonic air embolism monitor.
- 868.2300 Bourdon gauge flowmeter.
- 868.2320 Uncompensated thorpe tube flowmeter.

868.2340	Compensated thorpe tube flowmeter.	868.5454	High flow humidified oxygen delivery device.
868.2350	Gas calibration flowmeter.	868.5460	Therapeutic humidifier for home use.
868.2375	Breathing frequency monitor.	868.5470	Hyperbaric chamber.
868.2377	Apnea monitor.	868.5530	Flexible laryngoscope.
868.2380	Nitric oxide analyzer.	868.5540	Rigid laryngoscope.
868.2385	Nitrogen dioxide analyzer.	868.5550	Anesthetic gas mask.
868.2450	Lung water monitor.	868.5560	Gas mask head strap.
868.2480	Cutaneous carbon dioxide (PcCO <sub>2</sub> ) monitor.	868.5570	Nonrebreathing mask.
868.2500	Cutaneous oxygen (PcO <sub>2</sub> ) monitor.	868.5580	Oxygen mask.
868.2550	Pneumotachometer.	868.5590	Scavenging mask.
868.2600	Airway pressure monitor.	868.5600	Venturi mask.
868.2610	Gas pressure gauge.	868.5620	Breathing mouthpiece.
868.2620	Gas pressure calibrator.	868.5630	Nebulizer.
868.2700	Pressure regulator.	868.5640	Medicinal nonventilatory nebulizer (atomizer).
868.2775	Electrical peripheral nerve stimulator.	868.5650	Esophageal obturator.
868.2875	Differential pressure transducer.	868.5655	Portable liquid oxygen unit.
868.2885	Gas flow transducer.	868.5665	Powered percussor.
868.2900	Gas pressure transducer.	868.5675	Rebreathing device.

**Subparts D-E [Reserved]****Subpart F—Therapeutic Devices**

868.5090	Emergency airway needle.	868.5700	Nonpowered oxygen tent.
868.5100	Nasopharyngeal airway.	868.5710	Electrically powered oxygen tent.
868.5105	External negative pressure airway aid.	868.5720	Bronchial tube.
868.5110	Oropharyngeal airway.	868.5730	Tracheal tube.
868.5115	Device to relieve acute upper airway obstruction.	868.5740	Tracheal/bronchial differential ventilation tube.
868.5120	Anesthesia conduction catheter.	868.5750	Inflatable tracheal tube cuff.
868.5130	Anesthesia conduction filter.	868.5760	Cuff spreader.
868.5140	Anesthesia conduction kit.	868.5770	Tracheal tube fixation device.
868.5150	Anesthesia conduction needle.	868.5780	Tube introduction forceps.
868.5160	Gas machine for anesthesia or analgesia.	868.5790	Tracheal tube stylet.
868.5165	Nitric oxide administration apparatus.	868.5795	Tracheal tube cleaning brush.
868.5170	Laryngotracheal topical anesthesia applicator.	868.5800	Tracheostomy tube and tube cuff.
868.5180	Rocking bed.	868.5810	Airway connector.
868.5220	Blow bottle.	868.5820	Dental protector.
868.5240	Anesthesia breathing circuit.	868.5830	Autotransfusion apparatus.
868.5250	Breathing circuit circulator.	868.5860	Pressure tubing and accessories.
868.5260	Breathing circuit bacterial filter.	868.5870	Nonrebreathing valve.
868.5270	Breathing system heater.	868.5880	Anesthetic vaporizer.
868.5273	Positive airway pressure delivery system.	868.5895	Continuous ventilator.
868.5280	Breathing tube support.	868.5905	Noncontinuous ventilator (IPPB).
868.5300	Carbon dioxide absorbent.	868.5915	Manual emergency ventilator.
868.5310	Carbon dioxide absorber.	868.5925	Powered emergency ventilator.
868.5320	Reservoir bag.	868.5935	External negative pressure ventilator.
868.5330	Breathing gas mixer.	868.5955	Intermittent mandatory ventilation attachment.
868.5340	Nasal oxygen cannula.	868.5965	Positive end expiratory pressure breathing attachment.
868.5350	Nasal oxygen catheter.	868.5975	Ventilator tubing.
868.5365	Posture chair for cardiac or pulmonary treatment.	868.5995	Tee drain (water trap).
868.5375	Heat and moisture condenser (artificial nose).		
868.5400	Electroanesthesia apparatus.		
868.5420	Ether hook.		
868.5430	Gas-scavenging apparatus.		
868.5440	Portable oxygen generator.		
868.5450	Respiratory gas humidifier.		

**Subpart G—Miscellaneous**

868.6100	Anesthetic cabinet, table, or tray.
868.6175	Cardiopulmonary emergency cart.
868.6225	Nose clip.
868.6250	Portable air compressor.
868.6400	Calibration gas.
868.6700	Anesthesia stool.
868.6810	Tracheobronchial suction catheter.
868.6820	Patient position support.
868.6885	Medical gas yoke assembly.

AUTHORITY: 21 U.S.C. 351, 360, 360c, 360e, 360j, 360f, 371.

SOURCE: 47 FR 31142, July 16, 1982, unless otherwise noted.

EDITORIAL NOTE: Nomenclature changes to part 868 appear at 73 FR 35341, June 23, 2008.

### Subpart A—General Provisions

#### § 868.1 Scope.

(a) This part sets forth the classification of anesthesiology devices intended for human use that are in commercial distribution.

(b) The identification of a device in a regulation in this part is not a precise description of every device that is, or will be, subject to the regulation. A manufacturer who submits a premarket notification submission for a device under part 807 may not show merely that the device is accurately described by the section title and identification provisions of a regulation in this part, but shall state why the device is substantially equivalent to other devices, as required by § 807.87.

(c) To avoid duplicative listings, an anesthesiology device that has two or more types of uses (e.g., used both as a diagnostic device and as a therapeutic device) is listed only in one subpart.

(d) References in this part to regulatory sections of the Code of Federal Regulations are to chapter I of title 21, unless otherwise noted.

(e) Guidance documents referenced in this part are available on the Internet at <http://www.fda.gov/MedicalDevices/DeviceRegulationandGuidance/GuidanceDocuments/default.htm>.

[52 FR 17734, May 11, 1987, as amended at 67 FR 76681, Dec. 13, 2002; 78 FR 18233, Mar. 26, 2013]

#### § 868.3 Effective dates of requirement for premarket approval.

A device included in this part that is classified into class III (premarket approval) shall not be commercially distributed after the date shown in the regulation classifying the device unless the manufacturer has an approval under section 515 of the act (unless an exemption has been granted under section 520(g)(2) of the act). An approval under section 515 of the act consists of FDA's issuance of an order approving an application for premarket approval (PMA) for the device or declaring com-

pleted a product development protocol (PDP) for the device.

(a) Before FDA requires that a device commercially distributed before the enactment date of the amendments, or a device that has been found substantially equivalent to such a device, has an approval under section 515 of the act FDA must promulgate a regulation under section 515(b) of the act requiring such approval, except as provided in paragraph (b) of this section. Such a regulation under section 515(b) of the act shall not be effective during the grace period ending on the 90th day after its promulgation or on the last day of the 30th full calendar month after the regulation that classifies the device into class III is effective, whichever is later. See section 501(f)(2)(B) of the act. Accordingly, unless an effective date of the requirement for premarket approval is shown in the regulation for a device classified into class III in this part, the device may be commercially distributed without FDA's issuance of an order approving a PMA or declaring completed a PDP for the device. If FDA promulgates a regulation under section 515(b) of the act requiring premarket approval for a device, section 501(f)(1)(A) of the act applies to the device.

(b) Any new, not substantially equivalent, device introduced into commercial distribution on or after May 28, 1976, including a device formerly marketed that has been substantially altered, is classified by statute (section 513(f) of the act) into class III without any grace period and FDA must have issued an order approving a PMA or declaring completed a PDP for the device before the device is commercially distributed unless it is reclassified. If FDA knows that a device being commercially distributed may be a "new" device as defined in this section because of any new intended use or other reasons, FDA may codify the statutory classification of the device into class III for such new use. Accordingly, the regulation for such a class III device states that as of the enactment date of the amendments, May 28, 1976, the device must have an approval under section 515 of the act before commercial distribution.

[52 FR 17734, May 11, 1987]

**§ 868.9 Limitations of exemptions from section 510(k) of the Federal Food, Drug, and Cosmetic Act (the act).**

The exemption from the requirement of premarket notification (section 510(k) of the act) for a generic type of class I or II device is only to the extent that the device has existing or reasonably foreseeable characteristics of commercially distributed devices within that generic type or, in the case of in vitro diagnostic devices, only to the extent that misdiagnosis as a result of using the device would not be associated with high morbidity or mortality. Accordingly, manufacturers of any commercially distributed class I or II device for which FDA has granted an exemption from the requirement of premarket notification must still submit a premarket notification to FDA before introducing or delivering for introduction into interstate commerce for commercial distribution the device when:

(a) The device is intended for a use different from the intended use of a legally marketed device in that generic type of device; e.g., the device is intended for a different medical purpose, or the device is intended for lay use where the former intended use was by health care professionals only;

(b) The modified device operates using a different fundamental scientific technology than a legally marketed device in that generic type of device; e.g., a surgical instrument cuts tissue with a laser beam rather than with a sharpened metal blade, or an in vitro diagnostic device detects or identifies infectious agents by using deoxyribonucleic acid (DNA) probe or nucleic acid hybridization technology rather than culture or immunoassay technology; or

(c) The device is an in vitro device that is intended:

(1) For use in the diagnosis, monitoring, or screening of neoplastic diseases with the exception of immunohistochemical devices;

(2) For use in screening or diagnosis of familial or acquired genetic disorders, including inborn errors of metabolism;

(3) For measuring an analyte that serves as a surrogate marker for screening, diagnosis, or monitoring

life-threatening diseases such as acquired immune deficiency syndrome (AIDS), chronic or active hepatitis, tuberculosis, or myocardial infarction or to monitor therapy;

(4) For assessing the risk of cardiovascular diseases;

(5) For use in diabetes management;

(6) For identifying or inferring the identity of a microorganism directly from clinical material;

(7) For detection of antibodies to microorganisms other than immunoglobulin G (IgG) or IgG assays when the results are not qualitative, or are used to determine immunity, or the assay is intended for use in matrices other than serum or plasma;

(8) For noninvasive testing as defined in § 812.3(k) of this chapter; and

(9) For near patient testing (point of care).

[65 FR 2313, Jan. 14, 2000]

**Subpart B—Diagnostic Devices**

**§ 868.1030 Manual algesimeter.**

(a) *Identification.* A manual algesimeter is a mechanical device intended to determine a patient's sensitivity to pain after administration of an anesthetic agent, e.g., by pricking with a sharp point.

(b) *Classification.* Class I (general controls). The device is exempt from the premarket notification procedures in subpart E of part 807 of this chapter subject to the limitations in § 868.9. The device is also exempt from the current good manufacturing practice requirements of the quality system regulation in part 820 of this chapter, with the exception of § 820.180, with respect to general requirements concerning records, and § 820.198, with respect to complaint files.

[54 FR 25048, June 12, 1989, as amended at 66 FR 38793, July 25, 2001]

**§ 868.1040 Powered algesimeter.**

(a) *Identification.* A powered algesimeter is a device using electrical stimulation intended to determine a patient's sensitivity to pain after administration of an anesthetic agent.

(b) *Classification.* Class II (special controls). The device is exempt from the premarket notification procedures

in subpart E of part 807 of this chapter subject to the limitations in § 868.9.

[47 FR 31142, July 16, 1982, as amended at 84 FR 71811, Dec. 30, 2019]

**§ 868.1075 Argon gas analyzer.**

(a) *Identification.* An argon gas analyzer is a device intended to measure the concentration of argon in a gas mixture to aid in determining the patient's ventilatory status. The device may use techniques such as mass spectrometry or thermal conductivity.

(b) *Classification.* Class II (performance standards).

**§ 868.1100 Arterial blood sampling kit.**

(a) *Identification.* An arterial blood sampling kit is a device, in kit form, used to obtain arterial blood samples from a patient for blood gas determinations. The kit may include a syringe, needle, cork, and heparin.

(b) *Classification.* Class I (general controls). The device is exempt from the premarket notification procedures in subpart E of part 807 of this chapter subject to the limitations in § 868.9.

[47 FR 31142, July 16, 1982, as amended at 61 FR 1119, Jan. 16, 1996; 66 FR 38793, July 25, 2001]

**§ 868.1120 Indwelling blood oxyhemoglobin concentration analyzer.**

(a) *Identification.* An indwelling blood oxyhemoglobin concentration analyzer is a photoelectric device used to measure, in vivo, the oxygen-carrying capacity of hemoglobin in blood to aid in determining the patient's physiological status.

(b) *Classification.* Class III (premarket approval).

(c) Date PMA or notice of completion of PDP is required. A PMA or notice of completion of a PDP is required to be filed with the Food and Drug Administration on or before September 21, 2004, for any indwelling blood oxyhemoglobin concentration analyzer that was in commercial distribution before May 28, 1976, or that has, on or before September 21, 2004, been found to be substantially equivalent to an indwelling blood oxyhemoglobin concentration analyzer that was in commercial distribution before May 28, 1976. Any other indwelling blood

oxyhemoglobin concentration analyzer shall have an approved PMA or declared completed PDP in effect before being placed in commercial distribution.

[47 FR 31142, July 16, 1982, as amended at 52 FR 17735, May 11, 1987; 52 FR 22577, June 12, 1987; 69 FR 34920, June 23, 2004]

**§ 868.1150 Indwelling blood carbon dioxide partial pressure (P<sub>2CO2</sub>) analyzer.**

(a) *Identification.* An indwelling blood carbon dioxide partial pressure P<sub>CO2</sub> analyzer is a device that consists of a catheter-tip P<sub>CO2</sub> transducer (e.g., P<sub>CO2</sub> electrode) and that is used to measure, in vivo, the partial pressure of carbon dioxide in blood to aid in determining the patient's circulatory, ventilatory, and metabolic status.

(b) *Classification.* Class II (special controls). The special control for this device is FDA's "Class II Special Controls Guidance Document: Indwelling Blood Gas Analyzers; Final Guidance for Industry and FDA."

[47 FR 31142, July 16, 1982; 47 FR 40410, Sept. 14, 1982, as amended at 52 FR 17735, May 11, 1987; 66 FR 57368, Nov. 15, 2001]

**§ 868.1170 Indwelling blood hydrogen ion concentration (pH) analyzer.**

(a) *Identification.* An indwelling blood hydrogen ion concentration (pH) analyzer is a device that consists of a catheter-tip pH electrode and that is used to measure, in vivo, the hydrogen ion concentration (pH) in blood to aid in determining the patient's acid-base balance.

(b) *Classification.* Class II (special controls). The special control for this device is FDA's "Class II Special Controls Guidance Document: Indwelling Blood Gas Analyzers; Final Guidance for Industry and FDA."

[47 FR 31142, July 16, 1982, as amended at 52 FR 17735, May 11, 1987; 66 FR 57368, Nov. 15, 2001]

**§ 868.1200 Indwelling blood oxygen partial pressure (P<sub>O2</sub>) analyzer.**

(a) *Identification.* An indwelling blood oxygen partial pressure (P<sub>O2</sub>) analyzer is a device that consists of a catheter-tip P<sub>O2</sub> transducer (e.g., P<sub>O2</sub> electrode) and that is used to measure, in vivo, the partial pressure of oxygen in blood

## § 868.1400

to aid in determining the patient's circulatory, ventilatory, and metabolic status.

(b) *Classification.* Class II (special controls). The special control for this device is FDA's "Class II Special Controls Guidance Document: Indwelling Blood Gas Analyzers; Final Guidance for Industry and FDA."

[47 FR 31142, July 16, 1982; 47 FR 40410, Sept. 14, 1982, as amended at 52 FR 17735, May 11, 1987; 66 FR 57368, Nov. 15, 2001]

### § 868.1400 Carbon dioxide gas analyzer.

(a) *Identification.* A carbon dioxide gas analyzer is a device intended to measure the concentration of carbon dioxide in a gas mixture to aid in determining the patient's ventilatory, circulatory, and metabolic status. The device may use techniques such as chemical titration, absorption of infrared radiation, gas chromatography, or mass spectrometry.

(b) *Classification.* Class II (performance standards).

### § 868.1430 Carbon monoxide gas analyzer.

(a) *Identification.* A carbon monoxide gas analyzer is a device intended to measure the concentration of carbon monoxide in a gas mixture to aid in determining the patient's ventilatory status. The device may use techniques such as infrared absorption or gas chromatography.

(b) *Classification.* Class II (performance standards).

### § 868.1500 Enflurane gas analyzer.

(a) *Identification.* An enflurane gas analyzer is a device intended to measure the concentration of enflurane anesthetic in a gas mixture.

(b) *Classification.* Class II (performance standards).

### § 868.1505 Ventilatory electrical impedance tomograph.

(a) *Identification.* A ventilatory electrical impedance tomograph is a prescription non-invasive, non-radiological ventilatory device that provides an assessment of local impedance variation within a cross-section of a patient's thorax.

## 21 CFR Ch. I (4-1-20 Edition)

(b) *Classification.* Class II (special controls). The special controls for this device are:

(1) The patient-contacting components of the device must be demonstrated to be biocompatible.

(2) Non-clinical performance testing must demonstrate that the device performs as intended under anticipated conditions of use, including the following:

(i) Characterization of device parameters, including signal-to-noise ratio, voltage accuracy, drift, reciprocity accuracy, amplitude response, position error, and ringing;

(ii) Real time evaluation of local impedance variation;

(iii) Plethysmogram accuracy testing; and

(iv) Use life testing of reusable components.

(3) Performance data must validate reprocessing instructions for any reusable components of the device.

(4) Performance data must demonstrate the electrical, thermal, and mechanical safety and the electromagnetic compatibility of the device.

(5) Software verification, validation, and hazard analysis must be performed.

(6) Labeling must include the following:

(i) Guidance for interpretation of the images generated;

(ii) A warning that the device should be removed before use of a defibrillator, or defibrillator interaction information based on defibrillator performance testing with the device;

(iii) A use life for any reusable components; and

(iv) Instructions for reprocessing any reusable components.

[84 FR 15098, Apr. 15, 2019]

### § 868.1575 Gas collection vessel.

(a) *Identification.* A gas collection vessel is a container-like device intended to collect a patient's exhaled gases for subsequent analysis. It does not include a sampling pump.

(b) *Classification.* Class I (general controls). The device is exempt from the premarket notification procedures in



subpart E of part 807 of this chapter subject to the limitations in § 868.9.

[47 FR 31142, July 16, 1982, as amended at 61 FR 1119, Jan. 16, 1996; 66 FR 38793, July 25, 2001]

**§ 868.1620 Halothane gas analyzer.**

(a) *Identification.* A halothane gas analyzer is a device intended to measure the concentration of halothane anesthetic in a gas mixture. The device may use techniques such as mass spectrometry or absorption of infrared or ultraviolet radiation.

(b) *Classification.* Class II (performance standards).

**§ 868.1640 Helium gas analyzer.**

(a) *Identification.* A helium gas analyzer is a device intended to measure the concentration of helium in a gas mixture during pulmonary function testing. The device may use techniques such as thermal conductivity, gas chromatography, or mass spectrometry.

(b) *Classification.* Class II (performance standards).

**§ 868.1670 Neon gas analyzer.**

(a) *Identification.* A neon gas analyzer is a device intended to measure the concentration of neon in a gas mixture exhaled by a patient. The device may use techniques such as mass spectrometry or thermal conductivity.

(b) *Classification.* Class II (performance standards).

**§ 868.1690 Nitrogen gas analyzer.**

(a) *Identification.* A nitrogen gas analyzer is a device intended to measure the concentration of nitrogen in respiratory gases to aid in determining a patient's ventilatory status. The device may use techniques such as gas chromatography or mass spectrometry.

(b) *Classification.* Class II (performance standards).

**§ 868.1700 Nitrous oxide gas analyzer.**

(a) *Identification.* A nitrous oxide gas analyzer is a device intended to measure the concentration of nitrous oxide anesthetic in a gas mixture. The device may use techniques such as infrared absorption or mass spectrometry.

(b) *Classification.* Class II (performance standards).

**§ 868.1720 Oxygen gas analyzer.**

(a) *Identification.* An oxygen gas analyzer is a device intended to measure the concentration of oxygen in respiratory gases by techniques such as mass spectrometry, polarography, thermal conductivity, or gas chromatography. This generic type of device also includes paramagnetic analyzers.

(b) *Classification.* Class II (performance standards).

**§ 868.1730 Oxygen uptake computer.**

(a) *Identification.* An oxygen uptake computer is a device intended to compute the amount of oxygen consumed by a patient and may include components for determining expired gas volume and composition.

(b) *Classification.* Class II (performance standards).

**§ 868.1750 Pressure plethysmograph.**

(a) *Identification.* A pressure plethysmograph is a device used to determine a patient's airway resistance and lung volumes by measuring pressure changes while the patient is in an airtight box.

(b) *Classification.* Class II (performance standards).

**§ 868.1760 Volume plethysmograph.**

(a) *Identification.* A volume plethysmograph is an airtight box, in which a patient sits, that is used to determine the patient's lung volume changes.

(b) *Classification.* Class II (performance standards).

**§ 868.1780 Inspiratory airway pressure meter.**

(a) *Identification.* An inspiratory airway pressure meter is a device used to measure the amount of pressure produced in a patient's airway during maximal inspiration.

(b) *Classification.* Class II (performance standards).

**§ 868.1800 Rhinomanometer.**

(a) *Identification.* A rhinomanometer is a device used to quantify the amount of nasal congestion by measuring the airflow through, and differential pressure across, a patient's nasal passages.

**§ 868.1840**

(b) *Classification*. Class II (performance standards).

**§ 868.1840 Diagnostic spirometer.**

(a) *Identification*. A diagnostic spirometer is a device used in pulmonary function testing to measure the volume of gas moving in or out of a patient's lungs.

(b) *Classification*. Class II (performance standards).

**§ 868.1850 Monitoring spirometer.**

(a) *Identification*. A monitoring spirometer is a device used to measure continuously a patient's tidal volume (volume of gas inhaled by the patient during each respiration cycle) or minute volume (the tidal volume multiplied by the rate of respiration for 1 minute) for the evaluation of the patient's ventilatory status.

(b) *Classification*. Class II (performance standards).

**§ 868.1860 Peak-flow meter for spirometry.**

(a) *Identification*. A peak-flow meter for spirometry is a device used to measure a patient's maximum ventilatory flow rate.

(b) *Classification*. Class II (performance standards).

**§ 868.1870 Gas volume calibrator.**

(a) *Identification*. A gas volume calibrator is a device that is intended for medical purposes and that is used to calibrate the output of gas volume measurement instruments by delivering a known gas volume.

(b) *Classification*. Class I (general controls). The device is exempt from the premarket notification procedures in subpart E of part 807 of this chapter subject to the limitations in § 868.9.

[47 FR 31142, July 16, 1982, as amended at 61 FR 1119, Jan. 16, 1996; 66 FR 38793, July 25, 2001]

**§ 868.1880 Pulmonary-function data calculator.**

(a) *Identification*. A pulmonary-function data calculator is a device used to calculate pulmonary-function values based on actual physical data obtained during pulmonary-function testing.

(b) *Classification*. Class II (performance standards).

**21 CFR Ch. I (4–1–20 Edition)**

**§ 868.1890 Predictive pulmonary-function value calculator.**

(a) *Identification*. A predictive pulmonary-function value calculator is a device used to calculate normal pulmonary-function values based on empirical equations.

(b) *Classification*. Class II (performance standards).

**§ 868.1900 Diagnostic pulmonary-function interpretation calculator.**

(a) *Identification*. A diagnostic pulmonary-function interpretation calculator is a device that interprets pulmonary study data to determine clinical significance of pulmonary-function values.

(b) *Classification*. Class II (performance standards).

**§ 868.1910 Esophageal stethoscope.**

(a) *Identification*. An esophageal stethoscope is a nonpowered device that is inserted into a patient's esophagus to enable the user to listen to heart and breath sounds.

(b) *Classification*. Class I (general controls). The device is exempt from the premarket notification procedures in subpart E of part 807 of this chapter subject to § 868.9.

[47 FR 31142, July 16, 1982, as amended at 65 FR 2313, Jan. 14, 2000]

**§ 868.1920 Esophageal stethoscope with electrical conductors.**

(a) *Identification*. An esophageal stethoscope with electrical conductors is a device that is inserted into the esophagus to listen to a patient's heart and breath sounds and to monitor electrophysiological signals. The device may also incorporate a thermistor for temperature measurement.

(b) *Classification*. Class II (performance standards).

**§ 868.1930 Stethoscope head.**

(a) *Identification*. A stethoscope head is a weighted chest piece used during anesthesia to listen to a patient's heart, breath, and other physiological sounds.

(b) *Classification*. Class I (general controls). The device is exempt from the premarket notification procedures in

## Food and Drug Administration, HHS

## § 868.2340

subpart E of part 807 of this chapter subject to the limitations in § 868.9.

[47 FR 31142, July 16, 1982, as amended at 54 FR 25048, June 12, 1989; 66 FR 38793, July 25, 2001]

### § 868.1965 Switching valve (ploss).

(a) *Identification.* A switching valve (ploss) is a three-way valve located between a stethoscope placed over the heart, a blood pressure cuff, and an ear-piece. The valve allows the user to eliminate one sound channel and listen only to a patient's heart or korotkoff (blood pressure) sounds through the other channel.

(b) *Classification.* Class I (general controls). The device is exempt from the premarket notification procedures in subpart E of part 807 of this chapter subject to the limitations in § 868.9. The device is also exempt from the current good manufacturing practice requirements of the quality system regulation in part 820 of this chapter, with the exception of § 820.180, with respect to general requirements concerning records, and § 820.198, with respect to complaint files.

[47 FR 31142, July 16, 1982, as amended at 54 FR 25048, June 12, 1989; 66 FR 38793, July 25, 2001]

### § 868.1975 Water vapor analyzer.

(a) *Identification.* A water vapor analyzer is a device intended to measure the concentration of water vapor in a patient's expired gases by using techniques such as mass spectrometry.

(b) *Classification.* Class I (general controls). The device is exempt from the premarket notification procedures in subpart E of part 807 of this chapter subject to the limitations in § 868.9.

[47 FR 31142, July 16, 1982, as amended at 61 FR 1119, Jan. 16, 1996; 66 FR 38793, July 25, 2001]

## Subpart C—Monitoring Devices

### § 868.2025 Ultrasonic air embolism monitor.

(a) *Identification.* An ultrasonic air embolism monitor is a device used to detect air bubbles in a patient's blood stream. It may use Doppler or other ultrasonic principles.

(b) *Classification.* Class II (performance standards).

### § 868.2300 Bourdon gauge flowmeter.

(a) *Identification.* A bourdon gauge flowmeter is a device intended for medical purposes that is used in conjunction with respiratory equipment to sense gas pressure. The device is calibrated to indicate gas flow rate when the outflow is open to the atmosphere.

(b) *Classification.* Class I (general controls). The device is exempt from the premarket notification procedures in subpart E of part 807 of this chapter subject to the limitations in § 868.9.

[47 FR 31142, July 16, 1982, as amended at 61 FR 1119, Jan. 16, 1996; 66 FR 38794, July 25, 2001]

### § 868.2320 Uncompensated thorpe tube flowmeter.

(a) *Identification.* An uncompensated thorpe tube flowmeter is a device intended for medical purposes that is used to indicate and control gas flow rate accurately. The device includes a vertically mounted tube and is calibrated when the outlet of the flowmeter is open to the atmosphere.

(b) *Classification.* Class I (general controls). The device is exempt from the premarket notification procedures in subpart E of part 807 of this chapter subject to the limitations in § 868.9.

[47 FR 31142, July 16, 1982, as amended at 61 FR 1119, Jan. 16, 1996; 66 FR 38794, July 25, 2001]

### § 868.2340 Compensated thorpe tube flowmeter.

(a) *Identification.* A compensated thorpe tube flowmeter is a device intended for medical purposes that is used to control and measure gas flow rate accurately. The device includes a vertically mounted tube, with the outlet of the flowmeter calibrated to a reference pressure.

(b) *Classification.* Class I (general controls). The device is exempt from the premarket notification procedures in subpart E of part 807 of this chapter subject to the limitations in § 868.9.

[47 FR 31142, July 16, 1982, as amended at 61 FR 1119, Jan. 16, 1996; 66 FR 38794, July 25, 2001]

## § 868.2350

## 21 CFR Ch. I (4–1–20 Edition)

### § 868.2350 Gas calibration flowmeter.

(a) *Identification.* A gas calibration flowmeter is a device intended for medical purposes that is used to calibrate flowmeters and accurately measure gas flow.

(b) *Classification.* Class I (general controls). The device is exempt from the premarket notification procedures in subpart E of part 807 of this chapter subject to the limitations in § 868.9.

[47 FR 31142, July 16, 1982, as amended at 61 FR 1119, Jan. 16, 1996; 66 FR 38794, July 25, 2001]

### § 868.2375 Breathing frequency monitor.

(a) *Identification.* A breathing (ventilatory) frequency monitor is a device intended to measure or monitor a patient's respiratory rate. The device may provide an audible or visible alarm when the respiratory rate, averaged over time, is outside operator settable alarm limits. This device does not include the apnea monitor classified in § 868.2377.

(b) *Classification.* Class II (performance standards).

[47 FR 31142, July 16, 1982, as amended at 67 FR 46852, July 17, 2002]

### § 868.2377 Apnea monitor.

(a) *Identification.* An apnea monitor is a complete system intended to alarm primarily upon the cessation of breathing timed from the last detected breath. The apnea monitor also includes indirect methods of apnea detection such as monitoring of heart rate and other physiological parameters linked to the presence or absence of adequate respiration.

(b) *Classification.* Class II (special controls). The special control for this device is the FDA guidance document entitled "Class II Special Controls Guidance Document: Apnea Monitors; Guidance for Industry and FDA."

[67 FR 46852, July 17, 2002]

### § 868.2380 Nitric oxide analyzer.

(a) *Identification.* The nitric oxide analyzer is a device intended to measure the concentration of nitric oxide in respiratory gas mixtures during administration of nitric oxide.

(b) *Classification.* Class II. The special control for this device is FDA's "Guidance Document for Premarket Notification Submissions for Nitric Oxide Administration Apparatus, Nitric Oxide Analyzer, and Nitrogen Dioxide Analyzer."

[65 FR 14465, Mar. 3, 2000]

### § 868.2385 Nitrogen dioxide analyzer.

(a) *Identification.* The nitrogen dioxide analyzer is a device intended to measure the concentration of nitrogen dioxide in respiratory gas mixtures during administration of nitric oxide.

(b) *Classification.* Class II (special controls). The device, when it is a standalone nitrogen dioxide analyzer and not those that are components of nitric oxide delivery systems intended to monitor nitrogen dioxide levels during inhaled nitric oxide therapy, is exempt from the premarket notification procedures in subpart E of part 807 of this chapter subject to the limitations in § 868.9. The special control is FDA's "Guidance Document for Premarket Notification Submissions for Nitric Oxide Administration Apparatus, Nitric Oxide Analyzer, and Nitrogen Dioxide Analyzer." See § 868.1(e) for the availability of this guidance document.

[65 FR 11465, Mar. 3, 2000, as amended at 84 FR 71811, Dec. 30, 2019]

### § 868.2450 Lung water monitor.

(a) *Identification.* A lung water monitor is a device used to monitor the trend of fluid volume changes in a patient's lung by measuring changes in thoracic electrical impedance (resistance to alternating current) by means of electrodes placed on the patient's chest.

(b) *Classification.* Class III (premarket approval).

(c) *Date PMA or notice of completion of a PDP is required.* A PMA or a notice of completion of a PDP for a device is required to be filed with the Food and Drug Administration on or before July 12, 2000, for any lung water monitor that was in commercial distribution before May 28, 1976, or that has, on or before July 12, 2000, been found to be substantially equivalent to a lung water monitor that was in commercial distribution before May 28, 1976. Any

other lung water monitor device shall have an approved PMA or declared completed PDP in effect before being placed in commercial distribution.

[47 FR 31142, July 16, 1982, as amended at 52 FR 17735, May 11, 1987; 65 FR 19834, Apr. 13, 2000]

**§ 868.2480 Cutaneous carbon dioxide (PcCO<sub>2</sub>) monitor.**

(a) *Identification.* A cutaneous carbon dioxide (PcCO<sub>2</sub>) monitor is a noninvasive heated sensor and a pH-sensitive glass electrode placed on a patient's skin, which is intended to monitor relative changes in a hemodynamically stable patient's cutaneous carbon dioxide tension as an adjunct to arterial carbon dioxide tension measurement.

(b) *Classification.* Class II (special controls). The special control for this device is FDA's "Class II Special Controls Guidance Document: Cutaneous Carbon Dioxide (PcCO<sub>2</sub>) and Oxygen (PcO<sub>2</sub>) Monitors; Guidance for Industry and FDA." See § 868.1(e) for the availability of this guidance document.

[54 FR 27160, June 28, 1989, as amended at 67 FR 76681, Dec. 13, 2002]

**§ 868.2500 Cutaneous oxygen (PcO<sub>2</sub>) monitor.**

(a) *Identification.* A cutaneous oxygen (PcO<sub>2</sub>) monitor is a noninvasive, heated sensor (e.g., a Clark-type polarographic electrode) placed on the patient's skin that is intended to monitor relative changes in the cutaneous oxygen tension.

(b) *Classification.* Class II (special controls). The device is exempt from the premarket notification procedures in subpart E of part 807 of this chapter subject to the limitations in § 868.9. The special control is FDA's "Class II Special Controls Guidance Document: Cutaneous Carbon Dioxide (PcCO<sub>2</sub>) and Oxygen (PcO<sub>2</sub>) Monitors; Guidance for Industry and FDA." See § 868.1(e) for the availability of this guidance document.

[67 FR 76681, Dec. 13, 2002, as amended at 84 FR 71811, Dec. 30, 2019]

**§ 868.2550 Pneumotachometer.**

(a) *Identification.* A pneumotachometer is a device intended

for medical purposes that is used to determine gas flow by measuring the pressure differential across a known resistance. The device may use a set of capillaries or a metal screen for the resistive element.

(b) *Classification.* Class II (special controls). The device is exempt from the premarket notification procedures in subpart E of part 807 of this chapter subject to the limitations in § 868.9.

[47 FR 31142, July 16, 1982, as amended at 84 FR 71811, Dec. 30, 2019]

**§ 868.2600 Airway pressure monitor.**

(a) *Identification.* An airway pressure monitor is a device used to measure the pressure in a patient's upper airway. The device may include a pressure gauge and an alarm.

(b) *Classification.* Class II (performance standards).

**§ 868.2610 Gas pressure gauge.**

(a) *Identification.* A gas pressure gauge (e.g., bourdon tube pressure gauge) is a device intended for medical purposes that is used to measure gas pressure in a medical gas delivery system.

(b) *Classification.* Class I (general controls). The device is exempt from the premarket notification procedures in subpart E of part 807 of this chapter subject to the limitations in § 868.9.

[47 FR 31142, July 16, 1982, as amended at 61 FR 1119, Jan. 16, 1996; 66 FR 38794, July 25, 2001]

**§ 868.2620 Gas pressure calibrator.**

(a) *Identification.* A gas pressure calibrator is a device intended for medical purposes that is used to calibrate pressure-measuring instruments by generating a known gas pressure.

(b) *Classification.* Class I (general controls). The device is exempt from the premarket notification procedures in subpart E of part 807 of this chapter subject to the limitations in § 868.9.

[47 FR 31142, July 16, 1982, as amended at 61 FR 1119, Jan. 16, 1996; 66 FR 38794, July 25, 2001]

**§ 868.2700 Pressure regulator.**

(a) *Identification.* A pressure regulator is a device, often called a pressure-reducing valve, that is intended

## § 868.2775

for medical purposes and that is used to convert a medical gas pressure from a high variable pressure to a lower, more constant working pressure. This device includes mechanical oxygen regulators.

(b) *Classification.* Class I (general controls). The device is exempt from the premarket notification procedures in subpart E of part 807 of this chapter subject to the limitations in § 868.9.

[47 FR 31142, July 16, 1982, as amended at 61 FR 1119, Jan. 16, 1996; 66 FR 38794, July 25, 2001]

## § 868.2775 Electrical peripheral nerve stimulator.

(a) *Identification.* An electrical peripheral nerve stimulator (neuromuscular blockade monitor) is a device used to apply an electrical current to a patient to test the level of pharmacological effect of anesthetic drugs and gases.

(b) *Classification.* Class II (performance standards).

## § 868.2875 Differential pressure transducer.

(a) *Identification.* A differential pressure transducer is a two-chambered device intended for medical purposes that is often used during pulmonary function testing. It generates an electrical signal for subsequent display or processing that is proportional to the difference in gas pressures in the two chambers.

(b) *Classification.* Class I (general controls). The device is exempt from the premarket notification procedures in subpart E of part 807 of this chapter subject to the limitations in § 868.9.

[47 FR 31142, July 16, 1982, as amended at 61 FR 1119, Jan. 16, 1996; 66 FR 38794, July 25, 2001]

## § 868.2885 Gas flow transducer.

(a) *Identification.* A gas flow transducer is a device intended for medical purposes that is used to convert gas flow rate into an electrical signal for subsequent display or processing.

(b) *Classification.* Class I (general controls). The device is exempt from the premarket notification procedures in

## 21 CFR Ch. I (4–1–20 Edition)

subpart E of part 807 of this chapter subject to the limitations in § 868.9.

[47 FR 31142, July 16, 1982, as amended at 61 FR 1119, Jan. 16, 1996; 66 FR 38794, July 25, 2001]

## § 868.2900 Gas pressure transducer.

(a) *Identification.* A gas pressure transducer is a device intended for medical purposes that is used to convert gas pressure into an electrical signal for subsequent display or processing.

(b) *Classification.* Class I. The device is exempt from the premarket notification procedures in subpart E of part 807 of this chapter.

[47 FR 31142, July 16, 1982, as amended at 61 FR 1120, Jan. 16, 1996]

## Subparts D–E [Reserved]

## Subpart F—Therapeutic Devices

### § 868.5090 Emergency airway needle.

(a) *Identification.* An emergency airway needle is a device intended to puncture a patient's cricothyroid membrane to provide an emergency airway during upper airway obstruction.

(b) *Classification.* Class II (performance standards).

### § 868.5100 Nasopharyngeal airway.

(a) *Identification.* A nasopharyngeal airway is a device used to aid breathing by means of a tube inserted into a patient's pharynx through the nose to provide a patent airway.

(b) *Classification.* Class I (general controls). The device is exempt from the premarket notification procedures in subpart E of part 807 of this chapter subject to the limitations in § 868.9.

[47 FR 31142, July 16, 1982, as amended at 61 FR 1120, Jan. 16, 1996; 66 FR 38794, July 25, 2001]

### § 868.5105 External negative pressure airway aid.

(a) *Identification.* An external negative pressure airway aid is a prescription device that applies negative pressure to a patient's neck to aid in providing a patent airway during procedures requiring anesthesia.

(b) *Classification*. Class II (special controls). The special controls for this device are:

(1) Clinical performance testing must document any adverse events observed during clinical use, including impaired blood flow, and demonstrate that the device performs as intended under anticipated conditions.

(2) Non-clinical performance testing must demonstrate that the device performs as intended under anticipated patient positions, does not fail during use, and does not lose negative pressure capability. The following testing should be performed:

(i) Ability of the device to maintain a seal during various patient positions;

(ii) Device leakage testing to demonstrate the device maintains vacuum;

(iii) Drop testing to ensure the device does not incur functional damage after dropping the device; and

(iv) Functional testing after high and low storage temperature.

(3) All patient contacting components must be demonstrated to be biocompatible.

(4) Labeling must include:

(i) A summary of clinical testing results, including any adverse events and evidence that effectiveness has been achieved.

(ii) Technical specifications of the device, including collar sizes, maximum duration of use, operating temperature, and storage temperature range.

(iii) Technical specifications of the vacuum source, including maximum vacuum level and operational vacuum level.

(iv) Instructions for use that includes how to place the device, determination of size, verification of suction, reference to training materials, and information on troubleshooting the device if it does not attach properly.

(v) A warning to screen patients for carotid artery disease due to the probable risk of the device to dislodge arterial plaques in the carotid artery.

(vi) A warning to exclude patients with anatomical abnormalities.

(vii) A warning not to use the device during medical procedures involving medications that contain propofol.

[82 FR 60867, Dec. 26, 2017]

#### § 868.5110 Oropharyngeal airway.

(a) *Identification*. An oropharyngeal airway is a device inserted into a patient's pharynx through the mouth to provide a patent airway.

(b) *Classification*. Class I (general controls). The device is exempt from the premarket notification procedures in subpart E of part 807 of this chapter subject to the limitations in § 868.9.

[47 FR 31142, July 16, 1982, as amended at 61 FR 1120, Jan. 16, 1996; 66 FR 38794, July 25, 2001]

#### § 868.5115 Device to relieve acute upper airway obstruction.

(a) *Identification*. The device is a raised, rounded pad that, in the event of choking on a foreign body, can be applied to the abdomen and pushed upward to generate expulsion pressure to remove the obstruction to relieve acute upper airway obstruction.

(b) *Classification*. Class II (special controls) (“Class II Special Control Guidance Document for Acute Upper Airway Obstruction Devices”). The device is exempt from the premarket notification procedures in subpart E of part 807 of this chapter, subject to § 868.9.

[65 FR 39099, June 23, 2000; 65 FR 47669, Aug. 3, 2000]

#### § 868.5120 Anesthesia conduction catheter.

(a) *Identification*. An anesthesia conduction catheter is a flexible tubular device used to inject local anesthetics into a patient and to provide continuous regional anesthesia.

(b) *Classification*. Class II (performance standards).

#### § 868.5130 Anesthesia conduction filter.

(a) *Identification*. An anesthesia conduction filter is a microporous filter used while administering to a patient injections of local anesthetics to minimize particulate (foreign material) contamination of the injected fluid.

(b) *Classification*. Class II (performance standards).

**§ 868.5140**

**21 CFR Ch. I (4–1–20 Edition)**

**§ 868.5140 Anesthesia conduction kit.**

(a) *Identification.* An anesthesia conduction kit is a device used to administer to a patient conduction, regional, or local anesthesia. The device may contain syringes, needles, and drugs.

(b) *Classification.* Class II (performance standards).

**§ 868.5150 Anesthesia conduction needle.**

(a) *Identification.* An anesthesia conduction needle is a device used to inject local anesthetics into a patient to provide regional anesthesia.

(b) *Classification.* Class II (performance standards).

**§ 868.5160 Gas machine for anesthesia or analgesia.**

(a) *Gas machine for anesthesia—(1) Identification.* A gas machine for anesthesia is a device used to administer to a patient, continuously or intermittently, a general inhalation anesthetic and to maintain a patient's ventilation. The device may include a gas flowmeter, vaporizer, ventilator, breathing circuit with bag, and emergency air supply.

(2) *Classification.* Class II (performance standards).

(b) *Gas machine for analgesia—(1) Identification.* A gas machine for analgesia is a device used to administer to a patient an analgesic agent, such as a nitrous oxide-oxygen mixture (maximum concentration of 70 percent nitrous oxide).

(2) *Classification.* Class II (performance standards).

**§ 868.5165 Nitric oxide administration apparatus.**

(a) *Identification.* The nitric oxide administration apparatus is a device used to add nitric oxide to gases that are to be breathed by a patient. The nitric oxide administration apparatus is to be used in conjunction with a ventilator or other breathing gas administration system.

(b) *Classification.* Class II. The special control for this device is FDA's "Guidance Document for Premarket Notification Submissions for Nitric Oxide Administration Apparatus, Nitric

Oxide Analyzer, and Nitrogen Dioxide Analyzer."

[65 FR 11465, Mar. 3, 2000]

**§ 868.5170 Laryngotracheal topical anesthesia applicator.**

(a) *Identification.* A laryngotracheal topical anesthesia applicator is a device used to apply topical anesthetics to a patient's laryngotracheal area.

(b) *Classification.* Class II (performance standards).

**§ 868.5180 Rocking bed.**

(a) *Identification.* A rocking bed is a device intended for temporary use to help patient ventilation (breathing) by repeatedly tilting the patient, thereby using the weight of the abdominal contents to move the diaphragm.

(b) *Classification.* Class II (special controls). The device is exempt from the premarket notification procedures in subpart E of part 807 of this chapter subject to the limitations in § 868.9.

[47 FR 31142, July 16, 1982, as amended at 84 FR 71811, Dec. 30, 2019]

**§ 868.5220 Blow bottle.**

(a) *Identification.* A blow bottle is a device that is intended for medical purposes to induce a forced expiration from a patient. The patient blows into the device to move a column of water from one bottle to another.

(b) *Classification.* Class I (general controls). The device is exempt from the premarket notification procedures in subpart E of part 807 of this chapter subject to the limitations in § 868.9. If the device is not labeled or otherwise represented as sterile, it is exempt from the current good manufacturing practice requirements of the quality system regulation in part 820 of this chapter, with the exception of § 820.180, with respect to general requirements concerning records, and § 820.198, with respect to complaint files.

[47 FR 31142, July 16, 1982, as amended at 54 FR 25048, June 12, 1989; 66 FR 38794, July 25, 2001]

**§ 868.5240 Anesthesia breathing circuit.**

(a) *Identification.* An anesthesia breathing circuit is a device that is intended to administer medical gases to



a patient during anesthesia. It provides both an inhalation and exhalation route and may include a connector, adaptor, and Y-piece.

(b) *Classification*. Class I (general controls). The device is exempt from the premarket notification procedures in subpart E of part 807 of this chapter subject to the limitations in § 868.9.

[47 FR 31142, July 16, 1982, as amended at 61 FR 1120, Jan. 16, 1996; 66 FR 38794, July 25, 2001]

#### § 868.5250 Breathing circuit circulator.

(a) *Identification*. A breathing circuit circulator is a turbine device that is attached to a closed breathing circuit and that is intended to circulate anesthetic gases continuously by maintaining the unidirectional valves in an open position and reducing mechanical dead space and resistance in the breathing circuit.

(b) *Classification*. Class II (performance standards).

#### § 868.5260 Breathing circuit bacterial filter.

(a) *Identification*. A breathing circuit bacterial filter is a device that is intended to remove microbiological and particulate matter from the gases in the breathing circuit.

(b) *Classification*. Class II (performance standards).

#### § 868.5270 Breathing system heater.

(a) *Identification*. A breathing system heater is a device that is intended to warm breathing gases before they enter a patient's airway. The device may include a temperature controller.

(b) *Classification*. Class II (performance standards).

#### § 868.5273 Positive airway pressure delivery system.

(a) *Identification*. A positive airway pressure delivery system is a prescription noninvasive ventilatory device that delivers expiratory positive airway pressure for patients suffering from obstructive sleep apnea. The system also provides positive airway pressure during incipient apnea. The system may include a dedicated flow generator and a patient interface.

(b) *Classification*. Class II (special controls). The special controls for this device are:

(1) The patient-contacting components of the device must be demonstrated to be biocompatible.

(2) Non-clinical performance testing must demonstrate that the device performs as intended under anticipated conditions of use, including the following:

(i) Waveform testing must simulate breathing conditions and evaluate pressure and airflow response over a range and combination of high and low breath rates and tidal volumes.

(ii) Use life testing must demonstrate adequate device performance over the labeled use life of the device.

(iii) Device integrity testing must demonstrate that the device can withstand typical forces expected during use.

(iv) Carbon dioxide rebreathing testing must be performed.

(v) System flow rate, maximum expiratory pressure, inhalation pressure, and intra-mask static pressure testing must be performed.

(vi) Air bolus testing must demonstrate that the device can withstand worst-case scenario air pressures.

(vii) Maximum limited pressure testing of the flow generator in single fault condition must be performed.

(viii) Maximum output temperature testing of delivered gas, if humidified, must be performed.

(3) Performance data must validate reprocessing instructions for any reusable components of the device.

(4) Performance data must demonstrate the electrical, thermal, and mechanical safety and the electromagnetic compatibility of the device.

(5) Software verification, validation, and hazard analysis must be performed.

(6) Labeling must include the following:

(i) Therapy pressure range;

(ii) Use life and replacement schedule for all components;

(iii) Cleaning instructions; and

(iv) Instructions for assembly and connection of device components.

[83 FR 52966, Oct. 19, 2018]

**§ 868.5280**

**21 CFR Ch. I (4–1–20 Edition)**

**§ 868.5280 Breathing tube support.**

(a) *Identification.* A breathing tube support is a device that is intended to support and anchor a patient's breathing tube(s).

(b) *Classification.* Class I (general controls). The device is exempt from the premarket notification procedures in subpart E of part 807 of this chapter subject to the limitations in § 868.9.

[47 FR 31142, July 16, 1982, as amended at 54 FR 25048, June 12, 1989; 66 FR 38794, July 25, 2001]

**§ 868.5300 Carbon dioxide absorbent.**

(a) *Identification.* A carbon dioxide absorbent is a device intended for medical purposes that consists of an absorbent material (e.g., soda lime) that is intended to remove carbon dioxide from the gases in the breathing circuit.

(b) *Classification.* Class I (general controls). The device is exempt from the premarket notification procedures in subpart E of part 807 of this chapter subject to the limitations in § 868.9.

[47 FR 31142, July 16, 1982, as amended at 61 FR 1120, Jan. 16, 1996; 66 FR 38794, July 25, 2001]

**§ 868.5310 Carbon dioxide absorber.**

(a) *Identification.* A carbon dioxide absorber is a device that is intended for medical purposes and that is used in a breathing circuit as a container for carbon dioxide absorbent. It may include a canister and water drain.

(b) *Classification.* Class I (general controls). The device is exempt from the premarket notification procedures in subpart E of part 807 of this chapter subject to the limitations in § 868.9.

[47 FR 31142, July 16, 1982, as amended at 61 FR 1120, Jan. 16, 1996; 66 FR 38794, July 25, 2001]

**§ 868.5320 Reservoir bag.**

(a) *Identification.* A reservoir bag is a device, usually made of conductive rubber, intended for use in a breathing circuit as a reservoir for breathing gas and to assist, control, or monitor a patient's ventilation.

(b) *Classification.* Class I (general controls). The device is exempt from the premarket notification procedures in

subpart E of part 807 of this chapter subject to the limitations in § 868.9.

[47 FR 31142, July 16, 1982, as amended at 61 FR 1120, Jan. 16, 1996; 66 FR 38794, July 25, 2001]

**§ 868.5330 Breathing gas mixer.**

(a) *Identification.* A breathing gas mixer is a device intended for use in conjunction with a respiratory support apparatus to control the mixing of gases that are to be breathed by a patient.

(b) *Classification.* Class II (performance standards).

**§ 868.5340 Nasal oxygen cannula.**

(a) *Identification.* A nasal oxygen cannula is a two-pronged device used to administer oxygen to a patient through both nostrils.

(b) *Classification.* Class I (general controls). The device is exempt from the premarket notification procedures in subpart E of part 807 of this chapter subject to the limitations in § 868.9.

[47 FR 31142, July 16, 1982, as amended at 59 FR 63007, Dec. 7, 1994; 66 FR 38794, July 25, 2001]

**§ 868.5350 Nasal oxygen catheter.**

(a) *Identification.* A nasal oxygen catheter is a device intended to be inserted through a patient's nostril to administer oxygen.

(b) *Classification.* Class I (general controls). The device is exempt from the premarket notification procedures in subpart E of part 807 of this chapter subject to the limitations in § 868.9.

[47 FR 31142, July 16, 1982, as amended at 59 FR 63007, Dec. 7, 1994; 66 FR 38794, July 25, 2001]

**§ 868.5365 Posture chair for cardiac or pulmonary treatment.**

(a) *Identification.* A posture chair for cardiac or pulmonary treatment is a device intended to assist in the rehabilitation and mobilization of patients with chronic heart or lung disease.

(b) *Classification.* Class I (general controls). The device is exempt from the premarket notification procedures in

**Food and Drug Administration, HHS**

**§ 868.5450**

subpart E of part 807 of this chapter subject to the limitations in § 868.9.

[47 FR 31142, July 16, 1982, as amended at 54 FR 25048, June 12, 1989; 66 FR 38794, July 25, 2001]

**§ 868.5375 Heat and moisture condenser (artificial nose).**

(a) *Identification.* A heat and moisture condenser (artificial nose) is a device intended to be positioned over a tracheotomy (a surgically created opening in the throat) or tracheal tube (a tube inserted into the trachea) to warm and humidify gases breathed in by a patient.

(b) *Classification.* Class I (general controls). The device is exempt from the premarket notification procedures in subpart E of part 807 of this chapter subject to the limitations in § 868.9.

[47 FR 31142, July 16, 1982, as amended at 61 FR 1120, Jan. 16, 1996; 66 FR 38795, July 25, 2001]

**§ 868.5400 Electroanesthesia apparatus.**

(a) *Identification.* An electroanesthesia apparatus is a device used for the induction and maintenance of anesthesia during surgical procedures by means of an alternating or pulsed electric current that is passed through electrodes fixed to a patient's head.

(b) *Classification.* Class III (premarket approval).

(c) *Date PMA or notice of completion of a PDP is required.* A PMA or notice of completion of a PDP is required to be filed with the Food and Drug Administration on or before December 26, 1996 for any electroanesthesia apparatus that was in commercial distribution before May 28, 1976, or that has, on or before December 26, 1996 been found to be substantially equivalent to an electroanesthesia apparatus that was in commercial distribution before May 28, 1976. Any other electroanesthesia apparatus shall have an approved PMA or a declared completed PDP in effect before being placed in commercial distribution.

[47 FR 31142, July 16, 1982, as amended at 52 FR 17735, May 11, 1987; 61 FR 50706, Sept. 27, 1996]

**§ 868.5420 Ether hook.**

(a) *Identification.* An ether hook is a device that fits inside a patient's mouth and that is intended to deliver vaporized ether.

(b) *Classification.* Class I (general controls). The device is exempt from the premarket notification procedures in subpart E of part 807 of this chapter subject to the limitations in § 868.9. If the device is not labeled or otherwise represented as sterile, it is exempt from the current good manufacturing practice requirements of the quality system regulation in part 820 of this chapter, with the exception of § 820.180, with respect to general requirements concerning records, and § 820.198, with respect to complaint files.

[47 FR 31142, July 16, 1982, as amended at 54 FR 25048, June 12, 1989; 66 FR 38795, July 25, 2001]

**§ 868.5430 Gas-scavenging apparatus.**

(a) *Identification.* A gas-scavenging apparatus is a device intended to collect excess anesthetic, analgesic, or trace gases or vapors from a patient's breathing system, ventilator, or extracorporeal pump-oxygenator, and to conduct these gases out of the area by means of an exhaust system.

(b) *Classification.* Class II (performance standards).

**§ 868.5440 Portable oxygen generator.**

(a) *Identification.* A portable oxygen generator is a device that is intended to release oxygen for respiratory therapy by means of either a chemical reaction or physical means (e.g., a molecular sieve).

(b) *Classification.* Class II (performance standards).

**§ 868.5450 Respiratory gas humidifier.**

(a) *Identification.* A respiratory gas humidifier is a device that is intended to add moisture to, and sometimes to warm, the breathing gases for administration to a patient. Cascade, gas, heated, and prefilled humidifiers are included in this generic type of device.

(b) *Classification.* Class II (performance standards).

**§ 868.5454**

**21 CFR Ch. I (4–1–20 Edition)**

**§ 868.5454 High flow humidified oxygen delivery device.**

(a) *Identification.* A high flow humidified oxygen delivery device is a prescription device that delivers high flow oxygen with humidification for patients who are suffering from respiratory distress and/or hypoxemia.

(b) *Classification.* Class II (special controls). The special controls for this device are:

(1) The patient-contacting components of the device must be demonstrated to be biocompatible.

(2) Non-clinical performance testing must demonstrate that the device performs as intended under anticipated conditions for use, including the following:

(i) Alarm testing must be performed;

(ii) Continuous use thermal stability testing must be performed;

(iii) Humidity output testing must be performed; and

(iv) Blender performance testing must evaluate fraction of inspired oxygen ( $FiO_2$ ) blending accuracy.

(3) Performance data must validate cleaning instructions for any reusable components of the device.

(4) Electrical safety, thermal safety, mechanical safety, electromagnetic compatibility, and radiofrequency identification testing must be performed.

(5) Software verification, validation, and hazard analysis must be performed.

(6) Labeling must include:

(i) A description of available  $FiO_2$  ranges for different flowrates and inlet gas pressures;

(ii) Instructions for applicable flowrates for all intended populations;

(iii) A warning that patients on high flow oxygen are acute and require appropriate monitoring, to include pulse oximetry;

(iv) A warning regarding the risk of condensation at low set temperatures and certain flows; and

(v) A description of all alarms and their functions.

[83 FR 54007, Oct. 26, 2018]

**§ 868.5460 Therapeutic humidifier for home use.**

(a) *Identification.* A therapeutic humidifier for home use is a device that adds water vapor to breathing gases

and that is intended for respiratory therapy or other medical purposes. The vapor produced by the device pervades the area surrounding the patient, who breathes the vapor during normal respiration.

(b) *Classification.* Class I (general controls). The device is exempt from the premarket notification procedures in subpart E of part 807 of this chapter subject to the limitations in § 868.9.

[47 FR 31142, July 16, 1982; 47 FR 40410, Sept. 14, 1982, as amended at 61 FR 1120, Jan. 16, 1996; 66 FR 38795, July 25, 2001]

**§ 868.5470 Hyperbaric chamber.**

(a) *Identification.* A hyperbaric chamber is a device that is intended to increase the environmental oxygen pressure to promote the movement of oxygen from the environment to a patient's tissue by means of pressurization that is greater than atmospheric pressure. This device does not include topical oxygen chambers for extremities (§ 878.5650).

(b) *Classification.* Class II (performance standards).

**§ 868.5530 Flexible laryngoscope.**

(a) *Identification.* A flexible laryngoscope is a fiberoptic device used to examine and visualize a patient's upper airway and aid placement of a tracheal tube.

(b) *Classification.* Class I (general controls). The device is exempt from the premarket notification procedures in subpart E of part 807 of this chapter subject to the limitations in § 868.9.

[47 FR 41107, Sept. 17, 1982, as amended at 61 FR 1120, Jan. 16, 1996; 66 FR 38795, July 25, 2001]

**§ 868.5540 Rigid laryngoscope.**

(a) *Identification.* A rigid laryngoscope is a device used to examine and visualize a patient's upper airway and aid placement of a tracheal tube.

(b) *Classification.* Class I (general controls). The device is exempt from the premarket notification procedures in subpart E of part 807 of this chapter subject to the limitations in § 868.9.

[47 FR 41107, Sept. 17, 1982, as amended at 61 FR 1120, Jan. 16, 1996; 66 FR 38795, July 25, 2001]

**§ 868.5550 Anesthetic gas mask.**

(a) *Identification.* An anesthetic gas mask is a device, usually made of conductive rubber, that is positioned over a patient's nose or mouth to direct anesthetic gases to the upper airway.

(b) *Classification.* Class I (general controls). The device is exempt from the premarket notification procedures in subpart E of part 807 of this chapter subject to the limitations in § 868.9.

[47 FR 41107, Sept. 17, 1982, as amended at 61 FR 1120, Jan. 16, 1996; 66 FR 38795, July 25, 2001]

**§ 868.5560 Gas mask head strap.**

(a) *Identification.* A gas mask head strap is a device used to hold an anesthetic gas mask in position on a patient's face.

(b) *Classification.* Class I (general controls). The device is exempt from the premarket notification procedures in subpart E of part 807 of this chapter subject to the limitations in § 868.9.

[47 FR 41107, Sept. 17, 1982, as amended at 54 FR 25048, June 12, 1989; 66 FR 38795, July 25, 2001]

**§ 868.5570 Nonbreathing mask.**

(a) *Identification.* A nonbreathing mask is a device fitting over a patient's face to administer oxygen. It utilizes one-way valves to prevent the patient from rebreathing previously exhaled gases.

(b) *Classification.* Class I (general controls). The device is exempt from the premarket notification procedures in subpart E of part 807 of this chapter subject to the limitations in § 868.9.

[47 FR 31142, July 16, 1982, as amended at 61 FR 1120, Jan. 16, 1996; 66 FR 38795, July 25, 2001]

**§ 868.5580 Oxygen mask.**

(a) *Identification.* An oxygen mask is a device placed over a patient's nose, mouth, or tracheostomy to administer oxygen or aerosols.

(b) *Classification.* Class I (general controls). The device is exempt from the premarket notification procedures in subpart E of part 807 of this chapter subject to the limitations in § 868.9.

[47 FR 31142, July 16, 1982, as amended at 61 FR 1120, Jan. 16, 1996; 66 FR 38795, July 25, 2001]

**§ 868.5590 Scavenging mask.**

(a) *Identification.* A scavenging mask is a device positioned over a patient's nose to deliver anesthetic or analgesic gases to the upper airway and to remove excess and exhaled gas. It is usually used during dentistry.

(b) *Classification.* Class I (general controls). The device is exempt from the premarket notification procedures in subpart E of part 807 of this chapter subject to the limitations in § 868.9.

[47 FR 31142, July 16, 1982, as amended at 61 FR 1120, Jan. 16, 1996; 66 FR 38795, July 25, 2001]

**§ 868.5600 Venturi mask.**

(a) *Identification.* A venturi mask is a device containing an air-oxygen mixing mechanism that dilutes 100 percent oxygen to a predetermined concentration and delivers the mixed gases to a patient.

(b) *Classification.* Class I (general controls). The device is exempt from the premarket notification procedures in subpart E of part 807 of this chapter subject to the limitations in § 868.9.

[47 FR 31142, July 16, 1982, as amended at 61 FR 1120, Jan. 16, 1996; 66 FR 38795, July 25, 2001]

**§ 868.5620 Breathing mouthpiece.**

(a) *Identification.* A breathing mouthpiece is a rigid device that is inserted into a patient's mouth and that connects with diagnostic or therapeutic respiratory devices.

(b) *Classification.* Class I (general controls). The device is exempt from the premarket notification procedures in subpart E of part 807 of this chapter subject to § 868.9.

[47 FR 31142, July 16, 1982, as amended at 65 FR 2313, Jan. 14, 2000]

**§ 868.5630 Nebulizer.**

(a) *Identification.* A nebulizer is a device intended to spray liquids in aerosol form into gases that are delivered directly to the patient for breathing. Heated, ultrasonic, gas, venturi, and refillable nebulizers are included in this generic type of device.

(b) *Classification.* Class II (performance standards).

## § 868.5640

### § 868.5640 Medicinal nonventilatory nebulizer (atomizer).

(a) *Identification.* A medicinal nonventilatory nebulizer (atomizer) is a device that is intended to spray liquid medication in aerosol form into the air that a patient will breathe.

(b) *Classification.* Class I (general controls). The device is exempt from the premarket notification procedures in subpart E of part 807 of this chapter subject to § 868.9.

[47 FR 31142, July 16, 1982, as amended at 65 FR 2313, Jan. 14, 2000]

### § 868.5650 Esophageal obturator.

(a) *Identification.* An esophageal obturator is a device inserted through a patient's mouth to aid ventilation of the patient during emergency resuscitation by occluding (blocking) the esophagus, thereby permitting positive pressure ventilation through the trachea. The device consists of a closed-end semirigid esophageal tube that is attached to a face mask.

(b) *Classification.* Class II (performance standards).

### § 868.5655 Portable liquid oxygen unit.

(a) *Identification.* A portable liquid oxygen unit is a portable, thermally insulated container of liquid oxygen that is intended to supplement gases to be inhaled by a patient, is sometimes accompanied by tubing and an oxygen mask. An empty portable liquid oxygen unit is a device, while the oxygen contained therein is a drug.

(b) *Classification.* Class II (performance standards).

### § 868.5665 Powered percussor.

(a) *Identification.* A powered percussor is a device that is intended to transmit vibration through a patient's chest wall to aid in freeing mucus deposits in the lung in order to improve bronchial drainage and that may be powered by electricity or compressed gas.

(b) *Classification.* Class II (performance standards).

### § 868.5675 Rebreathing device.

(a) *Identification.* A rebreathing device is a device that enables a patient to rebreathe exhaled gases. It may be used in conjunction with pulmonary

## 21 CFR Ch. I (4–1–20 Edition)

function testing or for increasing minute ventilation.

(b) *Classification.* Class I (general controls). The device is exempt from the premarket notification procedures in subpart E of part 807 of this chapter subject to § 868.9.

[47 FR 31142, July 16, 1982, as amended at 65 FR 2313, Jan. 14, 2000]

### § 868.5690 Incentive spirometer.

(a) *Identification.* An incentive spirometer is a device that indicates a patient's breathing volume or flow and that provides an incentive to the patient to improve his or her ventilation.

(b) *Classification.* Class II (performance standards).

### § 868.5700 Nonpowered oxygen tent.

(a) *Identification.* A nonpowered oxygen tent is a device that encloses a patient's head and upper body to contain oxygen delivered to the patient for breathing. This generic type of device includes infant oxygen hoods.

(b) *Classification.* Class I (general controls). The device is exempt from the premarket notification procedures in subpart E of part 807 of this chapter subject to § 868.9.

[47 FR 31142, July 16, 1982, as amended at 65 FR 2313, Jan. 14, 2000]

### § 868.5710 Electrically powered oxygen tent.

(a) *Identification.* An electrically powered oxygen tent is a device that encloses a patient's head and, by means of an electrically powered unit, administers breathing oxygen and controls the temperature and humidity of the breathing gases. This generic type device includes the pediatric aerosol tent.

(b) *Classification.* Class II (performance standards).

### § 868.5720 Bronchial tube.

(a) *Identification.* A bronchial tube is a device used to differentially intubate a patient's bronchus (one of the two main branches of the trachea leading directly to the lung) in order to isolate a portion of lung distal to the tube.

(b) *Classification.* Class II (performance standards).

**§ 868.5730 Tracheal tube.**

(a) *Identification.* A tracheal tube is a device inserted into a patient's trachea via the nose or mouth and used to maintain an open airway.

(b) *Classification.* Class II (performance standards).

**§ 868.5740 Tracheal/bronchial differential ventilation tube.**

(a) *Identification.* A tracheal/bronchial differential ventilation tube is a device used to isolate the left or the right lung of a patient for anesthesia or pulmonary function testing.

(b) *Classification.* Class II (performance standards).

**§ 868.5750 Inflatable tracheal tube cuff.**

(a) *Identification.* An inflatable tracheal tube cuff is a device used to provide an airtight seal between a tracheal tube and a patient's trachea.

(b) *Classification.* Class II (performance standards).

**§ 868.5760 Cuff spreader.**

(a) *Identification.* A cuff spreader is a device used to install tracheal tube cuffs on tracheal or tracheostomy tubes.

(b) *Classification.* Class I (general controls). The device is exempt from the premarket notification procedures in subpart E of part 807 of this chapter subject to the limitations in § 868.9. If the device is not labeled or otherwise represented as sterile, it is exempt from the current good manufacturing practice requirements of the quality system regulation in part 820 of this chapter, with the exception of § 820.180, with respect to general requirements concerning records, and § 820.198, with respect to complaint files.

[47 FR 31142, July 16, 1982, as amended at 54 FR 25048, June 12, 1989; 66 FR 38795, July 25, 2001]

**§ 868.5770 Tracheal tube fixation device.**

(a) *Identification.* A tracheal tube fixation device is a device used to hold a tracheal tube in place, usually by means of straps or pinch rings.

(b) *Classification.* Class I (general controls). The device is exempt from the

premarket notification procedures in subpart E of part 807 of this chapter subject to the limitations in § 868.9.

[47 FR 31142, July 16, 1982, as amended at 61 FR 1120, Jan. 16, 1996; 66 FR 38795, July 25, 2001]

**§ 868.5780 Tube introduction forceps.**

(a) *Identification.* Tube introduction forceps (e.g., Magill forceps) are a right-angled device used to grasp a tracheal tube and place it in a patient's trachea.

(b) *Classification.* Class I (general controls). The device is exempt from the premarket notification procedures in subpart E of part 807 of this chapter subject to the limitations in § 868.9.

[47 FR 31142, July 16, 1982, as amended at 61 FR 1120, Jan. 16, 1996; 66 FR 38795, July 25, 2001]

**§ 868.5790 Tracheal tube stylet.**

(a) *Identification.* A tracheal tube stylet is a device used temporarily to make rigid a flexible tracheal tube to aid its insertion into a patient.

(b) *Classification.* Class I (general controls). The device is exempt from the premarket notification procedures in subpart E of part 807 of this chapter subject to the limitations in § 868.9.

[47 FR 31142, July 16, 1982, as amended at 61 FR 1120, Jan. 16, 1996; 66 FR 38795, July 25, 2001]

**§ 868.5795 Tracheal tube cleaning brush.**

(a) *Identification.* A tracheal tube cleaning brush is a device consisting of a brush with plastic bristles intended to clean tracheal cannula devices after their removal from patients.

(b) *Classification.* Class I (general controls). The device is exempt from the premarket notification procedures in subpart E of part 807 of this chapter subject to the limitations in § 868.9. If the device is not labeled or otherwise represented as sterile, it is exempt from the current good manufacturing practice requirements of the quality system regulation in part 820 of this chapter, with the exception of § 820.180, with respect to general requirements

## § 868.5800

concerning records, and § 820.198, with respect to complaint files.

[51 FR 40388, Nov. 6, 1986, as amended at 66 FR 38795, July 25, 2001]

### § 868.5800 Tracheostomy tube and tube cuff.

(a) *Identification.* A tracheostomy tube and tube cuff is a device intended to be placed into a surgical opening of the trachea to facilitate ventilation to the lungs. The cuff may be a separate or integral part of the tracheostomy tube and is, when inflated, intended to establish a seal between the tracheal wall and the tracheostomy tube. The cuff is used to prevent the patient's aspiration of substances, such as blood or vomit, or to provide a means for positive-pressure ventilation of the patient. This device is made of either stainless steel or plastic.

(b) *Classification.* Class II.

[51 FR 40389, Nov. 6, 1986]

### § 868.5810 Airway connector.

(a) *Identification.* An airway connector is a device intended to connect a breathing gas source to a tracheal tube, tracheostomy tube, or mask.

(b) *Classification.* Class I (general controls). The device is exempt from the premarket notification procedures in subpart E of part 807 of this chapter subject to the limitations in § 868.9.

[47 FR 31142, July 16, 1982, as amended at 61 FR 1120, Jan. 16, 1996; 66 FR 38795, July 25, 2001]

### § 868.5820 Dental protector.

(a) *Identification.* A dental protector is a device intended to protect a patient's teeth during manipulative procedures within a patient's oral cavity.

(b) *Classification.* Class I (general controls). The device is exempt from the premarket notification procedures in subpart E of part 807 of this chapter subject to the limitations in § 868.9.

[47 FR 31142, July 16, 1982, as amended at 61 FR 1120, Jan. 16, 1996; 66 FR 38795, July 25, 2001]

### § 868.5830 Autotransfusion apparatus.

(a) *Identification.* An autotransfusion apparatus is a device used to collect and reinfuse the blood lost by a patient due to surgery or trauma.

## 21 CFR Ch. I (4-1-20 Edition)

(b) *Classification.* Class II (performance standards).

### § 868.5860 Pressure tubing and accessories.

(a) *Identification.* Pressure tubing and accessories are flexible or rigid devices intended to deliver pressurized medical gases.

(b) *Classification.* Class I (general controls). The device is exempt from the premarket notification procedures in subpart E of part 807 of this chapter subject to the limitations in § 868.9.

[47 FR 31142, July 16, 1982, as amended at 61 FR 1120, Jan. 16, 1996; 66 FR 38796, July 25, 2001]

### § 868.5870 Nonrebreathing valve.

(a) *Identification.* A nonrebreathing valve is a one-way valve that directs breathing gas flow to the patient and vents exhaled gases into the atmosphere.

(b) *Classification.* Class II (performance standards).

### § 868.5880 Anesthetic vaporizer.

(a) *Identification.* An anesthetic vaporizer is a device used to vaporize liquid anesthetic and deliver a controlled amount of the vapor to the patient.

(b) *Classification.* Class II (performance standards).

### § 868.5895 Continuous ventilator.

(a) *Identification.* A continuous ventilator (respirator) is a device intended to mechanically control or assist patient breathing by delivering a predetermined percentage of oxygen in the breathing gas. Adult, pediatric, and neonatal ventilators are included in this generic type of device.

(b) *Classification.* Class II (performance standards).

### § 868.5905 Noncontinuous ventilator (IPPB).

(a) *Identification.* A noncontinuous ventilator (intermittent positive pressure breathing-IPPB) is a device intended to deliver intermittently an aerosol to a patient's lungs or to assist a patient's breathing.

(b) *Classification.* Class II (performance standards).



**§ 868.5915 Manual emergency ventilator.**

(a) *Identification.* A manual emergency ventilator is a device, usually incorporating a bag and valve, intended to provide emergency respiratory support by means of a face mask or a tube inserted into a patient's airway.

(b) *Classification.* Class II (performance standards).

**§ 868.5925 Powered emergency ventilator.**

(a) *Identification.* A powered emergency ventilator is a demand valve or inhalator intended to provide emergency respiratory support by means of a face mask or a tube inserted into a patient's airway.

(b) *Classification.* Class II (performance standards).

**§ 868.5935 External negative pressure ventilator.**

(a) *Identification.* An external negative pressure ventilator (e.g., iron lung, cuirass) is a device chamber that is intended to support a patient's ventilation by alternately applying and releasing external negative pressure over the diaphragm and upper trunk of the patient.

(b) *Classification.* Class II (performance standards).

**§ 868.5955 Intermittent mandatory ventilation attachment.**

(a) *Identification.* An intermittent mandatory ventilation (IMV) attachment is a device attached to a mechanical ventilator that allows spontaneous breathing by a patient while providing mechanical ventilation at a preset rate.

(b) *Classification.* Class II (performance standards).

**§ 868.5965 Positive end expiratory pressure breathing attachment.**

(a) *Identification.* A positive end expiratory pressure (PEEP) breathing attachment is a device attached to a ventilator that is used to elevate pressure in a patient's lungs above atmospheric pressure at the end of exhalation.

(b) *Classification.* Class II (performance standards).

**§ 868.5975 Ventilator tubing.**

(a) *Identification.* Ventilator tubing is a device intended for use as a conduit for gases between a ventilator and a patient during ventilation of the patient.

(b) *Classification.* Class I (general controls). The device is exempt from the premarket notification procedures in subpart E of part 807 of this chapter subject to the limitations in § 868.9.

[47 FR 31142, July 16, 1982, as amended at 61 FR 1120, Jan. 16, 1996; 66 FR 38796, July 25, 2001]

**§ 868.5995 Tee drain (water trap).**

(a) *Identification.* A tee drain (water trap) is a device intended to trap and drain water that collects in ventilator tubing during respiratory therapy, thereby preventing an increase in breathing resistance.

(b) *Classification.* Class I (general controls). The device is exempt from the premarket notification procedures in subpart E of part 807 of this chapter subject to the limitations in § 868.9.

[47 FR 31142, July 16, 1982, as amended at 61 FR 1120, Jan. 16, 1996; 66 FR 38796, July 25, 2001]

**Subpart G—Miscellaneous****§ 868.6100 Anesthetic cabinet, table, or tray.**

(a) *Identification.* An anesthetic cabinet, table, or tray is a device intended to store anesthetic equipment and drugs. The device is usually constructed to eliminate build-up of static electrical charges.

(b) *Classification.* Class I (general controls). The device is exempt from the premarket notification procedures in subpart E of part 807 of this chapter subject to the limitations in § 868.9.

[47 FR 31142, July 16, 1982, as amended at 54 FR 25048, June 12, 1989; 66 FR 38796, July 25, 2001]

**§ 868.6175 Cardiopulmonary emergency cart.**

(a) *Identification.* A cardiopulmonary emergency cart is a device intended to store and transport resuscitation supplies for emergency treatment. The device does not include any equipment used in cardiopulmonary resuscitation.

## § 868.6225

(b) *Classification*. Class I (general controls). The device is exempt from the premarket notification procedures in subpart E of part 807 of this chapter subject to the limitations in § 868.9. The device is also exempt from the current good manufacturing practice requirements of the quality system regulation in part 820 of this chapter, with the exception of § 820.180, with respect to general requirements concerning records, and § 820.198, with respect to complaint files.

[47 FR 31142, July 16, 1982, as amended at 54 FR 25048, June 12, 1989; 66 FR 38796, July 25, 2001]

## § 868.6225 Nose clip.

(a) *Identification*. A nose clip is a device intended to close a patient's external nares (nostrils) during diagnostic or therapeutic procedures.

(b) *Classification*. Class I (general controls). The device is exempt from the premarket notification procedures in subpart E of part 807 of this chapter subject to the limitations in § 868.9. The device is also exempt from the current good manufacturing practice requirements of the quality system regulation in part 820 of this chapter, with the exception of § 820.180, with respect to general requirements concerning records, and § 820.198, with respect to complaint files.

[47 FR 31142, July 16, 1982, as amended at 54 FR 25048, June 12, 1989; 66 FR 38796, July 25, 2001]

## § 868.6250 Portable air compressor.

(a) *Identification*. A portable air compressor is a device intended to provide compressed air for medical purposes, e.g., to drive ventilators and other respiratory devices.

(b) *Classification*. Class II (special controls). The device is exempt from the premarket notification procedures in subpart E of part 807 of this chapter subject to the limitations in § 868.9.

[47 FR 31142, July 16, 1982, as amended at 84 FR 71811, Dec. 30, 2019]

## § 868.6400 Calibration gas.

(a) *Identification*. A calibration gas is a device consisting of a container of gas of known concentration intended

## 21 CFR Ch. I (4–1–20 Edition)

to calibrate medical gas concentration measurement devices.

(b) *Classification*. Class I (general controls). The device is exempt from the premarket notification procedures in subpart E of part 807 of this chapter subject to the limitations in § 868.9.

[47 FR 31142, July 16, 1982, as amended at 61 FR 1121, Jan. 16, 1996; 66 FR 38796, July 25, 2001]

## § 868.6700 Anesthesia stool.

(a) *Identification*. An anesthesia stool is a device intended for use as a stool for the anesthesiologist in the operating room.

(b) *Classification*. Class I (general controls). The device is exempt from the premarket notification procedures in subpart E of part 807 of this chapter subject to the limitations in § 868.9.

[47 FR 31142, July 16, 1982, as amended at 54 FR 25049, June 12, 1989; 66 FR 38796, July 25, 2001]

## § 868.6810 Tracheobronchial suction catheter.

(a) *Identification*. A tracheobronchial suction catheter is a device used to aspirate liquids or semisolids from a patient's upper airway.

(b) *Classification*. Class I (general controls). The device is exempt from the premarket notification procedures in subpart E of part 807 of this chapter subject to § 868.9.

[47 FR 31142, July 16, 1982, as amended at 65 FR 2314, Jan. 14, 2000]

## § 868.6820 Patient position support.

(a) *Identification*. A patient position support is a device intended to maintain the position of an anesthetized patient during surgery.

(b) *Classification*. Class I (general controls). The device is exempt from the premarket notification procedures in subpart E of part 807 of this chapter subject to the limitations in § 868.9.

[47 FR 31142, July 16, 1982, as amended at 61 FR 1121, Jan. 16, 1996; 66 FR 38796, July 25, 2001]

## § 868.6885 Medical gas yoke assembly.

(a) *Identification*. A medical gas yoke assembly is a device intended to connect medical gas cylinders to regulators or needle valves to supply gases

for anesthesia or respiratory therapy. The device may include a particulate filter.

(b) *Classification.* Class I (general controls). The device is exempt from the premarket notification procedures in subpart E of part 807 of this chapter subject to the limitations in §868.9.

[47 FR 31142, July 16, 1982, as amended at 61 FR 1121, Jan. 16, 1996; 66 FR 38796, July 25, 2001]

## PART 870—CARDIOVASCULAR DEVICES

### Subpart A—General Provisions

Sec.

- 870.1 Scope.
- 870.3 Effective dates of requirement for premarket approval.
- 870.9 Limitations of exemptions from section 510(k) of the Federal Food, Drug, and Cosmetic Act (the act).

### Subpart B—Cardiovascular Diagnostic Devices

- 870.1025 Arrhythmia detector and alarm (including ST-segment measurement and alarm).
- 870.1100 Blood pressure alarm.
- 870.1110 Blood pressure computer.
- 870.1120 Blood pressure cuff.
- 870.1130 Noninvasive blood pressure measurement system.
- 870.1140 Venous blood pressure manometer.
- 870.1200 Diagnostic intravascular catheter.
- 870.1210 Continuous flush catheter.
- 870.1220 Electrode recording catheter or electrode recording probe.
- 870.1230 Fiberoptic oximeter catheter.
- 870.1240 Flow-directed catheter.
- 870.1250 Percutaneous catheter.
- 870.1251 Temporary catheter for embolic protection during transcatheter intracardiac procedures.
- 870.1255 Balloon aortic valvuloplasty catheter.
- 870.1270 Intracavitary phonocatheter system.
- 870.1280 Steerable catheter.
- 870.1290 Steerable catheter control system.
- 870.1300 Catheter cannula.
- 870.1310 Vessel dilator for percutaneous catheterization.
- 870.1330 Catheter guide wire.
- 870.1340 Catheter introducer.
- 870.1350 Catheter balloon repair kit.
- 870.1360 Trace microsphere.
- 870.1370 Catheter tip occluder.
- 870.1380 Catheter stylet.
- 870.1390 Trocar.
- 870.1415 Coronary vascular physiologic simulation software device.

- 870.1425 Programmable diagnostic computer.
- 870.1435 Single-function, preprogrammed diagnostic computer.
- 870.1450 Densitometer.
- 870.1650 Angiographic injector and syringe.
- 870.1660 Indicator injector.
- 870.1670 Syringe actuator for an injector.
- 870.1750 External programmable pacemaker pulse generator.
- 870.1800 Withdrawal-infusion pump.
- 870.1875 Stethoscope.
- 870.1915 Thermodilution probe.

### Subpart C—Cardiovascular Monitoring Devices

- 870.2050 Biopotential amplifier and signal conditioner.
- 870.2060 Transducer signal amplifier and signal conditioner.
- 870.2100 Cardiovascular blood flowmeter.
- 870.2120 Extravascular blood flow probe.
- 870.2200 Adjunctive cardiovascular status indicator.
- 870.2300 Cardiac monitor (including cardi tachometer and rate alarm).
- 870.2310 Apex cardiograph (vibrocardiograph).
- 870.2320 Ballistocardiograph.
- 870.2330 Echocardiograph.
- 870.2340 Electrocardiograph.
- 870.2350 Electrocardiograph lead switching adaptor.
- 870.2360 Electrocardiograph electrode.
- 870.2370 Electrocardiograph surface electrode tester.
- 870.2390 Phonocardiograph.
- 870.2400 Vectorcardiograph.
- 870.2450 Medical cathode-ray tube display.
- 870.2600 Signal isolation system.
- 870.2620 Line isolation monitor.
- 870.2640 Portable leakage current alarm.
- 870.2675 Oscillometer.
- 870.2700 Oximeter.
- 870.2710 Ear oximeter.
- 870.2750 Impedance phlebograph.
- 870.2770 Impedance plethysmograph.
- 870.2780 Hydraulic, pneumatic, or photoelectric plethysmographs.
- 870.2800 Medical magnetic tape recorder.
- 870.2810 Paper chart recorder.
- 870.2840 Apex cardiographic transducer.
- 870.2850 Extravascular blood pressure transducer.
- 870.2855 Implantable Intra-aneurysm Pressure Measurement System.
- 870.2860 Heart sound transducer.
- 870.2870 Catheter tip pressure transducer.
- 870.2880 Ultrasonic transducer.
- 870.2890 Vessel occlusion transducer.
- 870.2900 Patient transducer and electrode cable (including connector).
- 870.2910 Radiofrequency physiological signal transmitter and receiver.
- 870.2920 Telephone electrocardiograph transmitter and receiver.

**Subpart D—Cardiovascular Prosthetic Devices**

- 870.3250 Vascular clip.
- 870.3260 Vena cava clip.
- 870.3300 Vascular embolization device.
- 870.3375 Cardiovascular intravascular filter.
- 870.3450 Vascular graft prosthesis.
- 870.3460 Endovascular suturing system.
- 870.3470 Intracardiac patch or pledget made of polypropylene, polyethylene terephthalate, or polytetrafluoroethylene.
- 870.3535 Intra-aortic balloon and control system.
- 870.3545 Ventricular bypass (assist) device.
- 870.3600 External pacemaker pulse generator.
- 870.3605 Pacing system analyzer.
- 870.3610 Implantable pacemaker pulse generator.
- 870.3620 Pacemaker lead adaptor.
- 870.3630 Pacemaker generator function analyzer.
- 870.3640 Indirect pacemaker generator function analyzer.
- 870.3650 Pacemaker polymeric mesh bag.
- 870.3670 Pacemaker charger.
- 870.3680 Cardiovascular permanent or temporary pacemaker electrode.
- 870.3690 Pacemaker test magnet.
- 870.3700 Pacemaker programmers.
- 870.3710 Pacemaker repair or replacement material.
- 870.3720 Pacemaker electrode function tester.
- 870.3730 Pacemaker service tools.
- 870.3800 Annuloplasty ring.
- 870.3850 Carotid sinus nerve stimulator.
- 870.3925 Replacement heart valve.
- 870.3935 Prosthetic heart valve holder.
- 870.3945 Prosthetic heart valve sizer.

**Subpart E—Cardiovascular Surgical Devices**

- 870.4075 Endomyocardial biopsy device.
- 870.4100 Extracorporeal circuit and accessories for long-term respiratory/ cardiopulmonary failure.
- 870.4200 Cardiopulmonary bypass accessory equipment.
- 870.4205 Cardiopulmonary bypass bubble detector.
- 870.4210 Cardiopulmonary bypass vascular catheter, cannula, or tubing.
- 870.4220 Cardiopulmonary bypass heart-lung machine console.
- 870.4230 Cardiopulmonary bypass defoamer.
- 870.4240 Cardiopulmonary bypass heat exchanger.
- 870.4250 Cardiopulmonary bypass temperature controller.
- 870.4260 Cardiopulmonary bypass arterial line blood filter.
- 870.4270 Cardiopulmonary bypass cardiotomy suction line blood filter.

- 870.4280 Cardiopulmonary prebypass filter.
- 870.4290 Cardiopulmonary bypass adaptor, stopcock, manifold, or fitting.
- 870.4300 Cardiopulmonary bypass gas control unit.
- 870.4310 Cardiopulmonary bypass coronary pressure gauge.
- 870.4320 Cardiopulmonary bypass pulsatile flow generator.
- 870.4330 Cardiopulmonary bypass on-line blood gas monitor.
- 870.4340 Cardiopulmonary bypass level sensing monitor and/or control.
- 870.4350 Cardiopulmonary bypass oxygenator.
- 870.4360 Nonroller-type blood pump.
- 870.4370 Roller-type cardiopulmonary bypass blood pump.
- 870.4380 Cardiopulmonary bypass pump speed control.
- 870.4390 Cardiopulmonary bypass pump tubing.
- 870.4400 Cardiopulmonary bypass blood reservoir.
- 870.4410 Cardiopulmonary bypass in-line blood gas sensor.
- 870.4420 Cardiopulmonary bypass cardiotomy return sucker.
- 870.4430 Cardiopulmonary bypass intracardiac suction control.
- 870.4450 Vascular clamp.
- 870.4475 Surgical vessel dilator.
- 870.4500 Cardiovascular surgical instruments.
- 870.4510 Apical closure device.
- 870.4875 Intraluminal artery stripper.
- 870.4885 External vein stripper.

**Subpart F—Cardiovascular Therapeutic Devices**

- 870.5050 Patient care suction apparatus.
- 870.5100 Percutaneous Transluminal Coronary Angioplasty (PTCA) Catheter.
- 870.5150 Embolectomy catheter.
- 870.5175 Septostomy catheter.
- 870.5200 External cardiac compressor.
- 870.5210 Cardiopulmonary resuscitation (CPR) aid.
- 870.5225 External counter-pulsating device.
- 870.5300 DC-defibrillator (including paddles).
- 870.5310 Automated external defibrillator system.
- 870.5325 Defibrillator tester.
- 870.5550 External transcutaneous cardiac pacemaker (noninvasive).
- 870.5700 Steerable cardiac ablation catheter remote control system.
- 870.5800 Compressible limb sleeve.
- 870.5900 Thermal regulating system.
- 870.5910 Esophageal thermal regulation device.
- 870.5925 Automatic rotating tourniquet.

AUTHORITY: 21 U.S.C. 351, 360, 360c, 360e, 360j, 360f, 371.

SOURCE: 45 FR 7907, Feb. 5, 1980, unless otherwise noted.

EDITORIAL NOTE: Nomenclature changes to part 870 appear at 73 FR 35341, June 23, 2008.

### Subpart A—General Provisions

#### § 870.1 Scope.

(a) This part sets forth the classification of cardiovascular devices intended for human use that are in commercial distribution.

(b) The identification of a device in a regulation in this part is not a precise description of every device that is, or will be, subject to the regulation. A manufacturer who submits a premarket notification submission for a device under part 807 may not show merely that the device is accurately described by the section title and identification provisions of a regulation in this part, but shall state why the device is substantially equivalent to other devices, as required by § 807.87.

(c) To avoid duplicative listings, a cardiovascular device that has two or more types of uses (e.g., used both as a diagnostic device and as a therapeutic device) is listed only in one subpart.

(d) References in this part to regulatory sections of the Code of Federal Regulations are to chapter I of title 21, unless otherwise noted.

(e) Guidance documents referenced in this part are available on the Internet at <http://www.fda.gov/MedicalDevices/DeviceRegulationandGuidance/GuidanceDocuments/default.htm>.

[52 FR 17735, May 11, 1987, as amended at 68 FR 61344, Oct. 28, 2003; 78 FR 18233, Mar. 26, 2013]

#### § 870.3 Effective dates of requirement for premarket approval.

A device included in this part that is classified into class III (premarket approval) shall not be commercially distributed after the date shown in the regulation classifying the device unless the manufacturer has an approval under section 515 of the act (unless an exemption has been granted under section 520(g)(2) of the act). An approval under section 515 of the act consists of FDA's issuance of an order approving an application for premarket approval (PMA) for the device or declaring com-

pleted a product development protocol (PDP) for the device.

(a) Before FDA requires that a device commercially distributed before the enactment date of the amendments, or a device that has been found substantially equivalent to such a device, has an approval under section 515 of the act FDA must promulgate a regulation under section 515(b) of the act requiring such approval, except as provided in paragraph (b) of this section. Such a regulation under section 515(b) of the act shall not be effective during the grace period ending on the 90th day after its promulgation or on the last day of the 30th full calendar month after the regulation that classifies the device into class III is effective, whichever is later. See section 501(f)(2)(B) of the act. Accordingly, unless an effective date of the requirement for premarket approval is shown in the regulation for a device classified into class III in this part, the device may be commercially distributed without FDA's issuance of an order approving a PMA or declaring completed a PDP for the device. If FDA promulgates a regulation under section 515(b) of the act requiring premarket approval for a device, section 501(f)(1)(A) of the act applies to the device.

(b) Any new, not substantially equivalent, device introduced into commercial distribution on or after May 28, 1976, including a device formerly marketed that has been substantially altered, is classified by statute (section 513(f) of the act) into class III without any grace period and FDA must have issued an order approving a PMA or declaring completed a PDP for the device before the device is commercially distributed unless it is reclassified. If FDA knows that a device being commercially distributed may be a "new" device as defined in this section because of any new intended use or other reasons, FDA may codify the statutory classification of the device into class III for such new use. Accordingly, the regulation for such a class III device states that as of the enactment date of the amendments, May 28, 1976, the device must have an approval under section 515 of the act before commercial distribution.

[52 FR 17735, May 11, 1987]

**§ 870.9 Limitations of exemptions from section 510(k) of the Federal Food, Drug, and Cosmetic Act (the act).**

The exemption from the requirement of premarket notification (section 510(k) of the act) for a generic type of class I or II device is only to the extent that the device has existing or reasonably foreseeable characteristics of commercially distributed devices with that generic type or, in the case of in vitro diagnostic devices, only to the extent that misdiagnosis as a result of using the device would not be associated with high morbidity or mortality. Accordingly, manufacturers of any commercially distributed class I or II device for which FDA has granted an exemption from the requirement of premarket notification must still submit a premarket notification to FDA before introducing or delivering for introduction into interstate commerce for commercial distribution the device when:

(a) The device is intended for a use different from the intended use of a legally marketed device in that generic type of device; e.g., the device is intended for a different medical purpose, or the device is intended for lay use where the former intended use was by health care professionals only;

(b) The modified device operates using a different fundamental scientific technology than a legally marketed device in that generic type of device; e.g., a surgical instrument cuts tissue with a laser beam rather than with a sharpened metal blade, or an in vitro diagnostic device detects or identifies infectious agents by using deoxyribonucleic acid (DNA) probe or nucleic acid hybridization technology rather than culture or immunoassay technology; or

(c) The device is an in vitro device that is intended:

(1) For use in the diagnosis, monitoring, or screening of neoplastic diseases with the exception of immunohistochemical devices;

(2) For use in screening or diagnosis of familial or acquired genetic disorders, including inborn errors of metabolism;

(3) For measuring an analyte that serves as a surrogate marker for screening, diagnosis, or monitoring

life-threatening diseases such as acquired immune deficiency syndrome (AIDS), chronic or active hepatitis, tuberculosis, or myocardial infarction or to monitor therapy;

(4) For assessing the risk of cardiovascular diseases;

(5) For use in diabetes management;

(6) For identifying or inferring the identity of a microorganism directly from clinical material;

(7) For detection of antibodies to microorganisms other than immunoglobulin G (IgG) or IgG assays when the results are not qualitative, or are used to determine immunity, or the assay is intended for use in matrices other than serum or plasma;

(8) For noninvasive testing as defined in § 812.3(k) of this chapter; and

(9) For near patient testing (point of care).

[65 FR 2314, Jan. 14, 2000]

**Subpart B—Cardiovascular Diagnostic Devices**

**§ 870.1025 Arrhythmia detector and alarm (including ST-segment measurement and alarm).**

(a) *Identification.* The arrhythmia detector and alarm device monitors an electrocardiogram and is designed to produce a visible or audible signal or alarm when atrial or ventricular arrhythmia, such as premature contraction or ventricular fibrillation, occurs.

(b) *Classification.* Class II (special controls). The guidance document entitled “Class II Special Controls Guidance Document: Arrhythmia Detector and Alarm” will serve as the special control. See § 870.1 for the availability of this guidance document.

[68 FR 61344, Oct. 28, 2003]

**§ 870.1100 Blood pressure alarm.**

(a) *Identification.* A blood pressure alarm is a device that accepts the signal from a blood pressure transducer amplifier, processes the signal, and emits an alarm when the blood pressure falls outside a pre-set upper or lower limit.

(b) *Classification.* Class II (performance standards).

**Food and Drug Administration, HHS**

**§ 870.1250**

**§ 870.1110 Blood pressure computer.**

(a) *Identification.* A blood pressure computer is a device that accepts the electrical signal from a blood pressure transducer amplifier and indicates the systolic, diastolic, or mean pressure based on the input signal.

(b) *Classification.* Class II (performance standards).

**§ 870.1120 Blood pressure cuff.**

(a) *Identification.* A blood pressure cuff is a device that has an inflatable bladder in an inelastic sleeve (cuff) with a mechanism for inflating and deflating the bladder. The cuff is used in conjunction with another device to determine a subject's blood pressure.

(b) *Classification.* Class II (performance standards).

**§ 870.1130 Noninvasive blood pressure measurement system.**

(a) *Identification.* A noninvasive blood pressure measurement system is a device that provides a signal from which systolic, diastolic, mean, or any combination of the three pressures can be derived through the use of transducers placed on the surface of the body.

(b) *Classification.* Class II (performance standards).

**§ 870.1140 Venous blood pressure manometer.**

(a) *Identification.* A venous blood pressure manometer is a device attached to a venous catheter to indicate manometrically the central or peripheral venous pressure.

(b) *Classification.* Class II (performance standards).

**§ 870.1200 Diagnostic intravascular catheter.**

(a) *Identification.* An intravascular diagnostic catheter is a device used to record intracardiac pressures, to sample blood, and to introduce substances into the heart and vessels. Included in this generic device are right-heart catheters, left-heart catheters, and angiographic catheters, among others.

(b) *Classification.* Class II (performance standards).

**§ 870.1210 Continuous flush catheter.**

(a) *Identification.* A continuous flush catheter is an attachment to a cath-

eter-transducer system that permits continuous intravascular flushing at a slow infusion rate for the purpose of eliminating clotting, back-leakage, and waveform damping.

(b) *Classification.* Class II (performance standards).

**§ 870.1220 Electrode recording catheter or electrode recording probe.**

(a) *Identification.* An electrode recording catheter or an electrode recording probe is a device used to detect an intracardiac electrocardiogram, or to detect cardiac output or left-to-right heart shunts. The device may be unipolar or multipolar for electrocardiogram detection, or may be a platinum-tipped catheter which senses the presence of a special indicator for cardiac output or left-to-right heart shunt determinations.

(b) *Classification.* Class II (performance standards).

**§ 870.1230 Fiberoptic oximeter catheter.**

(a) *Identification.* A fiberoptic oximeter catheter is a device used to estimate the oxygen saturation of the blood. It consists of two fiberoptic bundles that conduct light at a desired wavelength through blood and detect the reflected and scattered light at the distal end of the catheter.

(b) *Classification.* Class II (performance standards).

**§ 870.1240 Flow-directed catheter.**

(a) *Identification.* A flow-directed catheter is a device that incorporates a gas-filled balloon to help direct the catheter to the desired position.

(b) *Classification.* Class II (performance standards).

**§ 870.1250 Percutaneous catheter.**

(a) *Identification.* A percutaneous catheter is a device that is introduced into a vein or artery through the skin using a dilator and a sheath (introducer) or guide wire.

(b) *Classification.* Class II (performance standards).

**§ 870.1251 Temporary catheter for embolic protection during transcatheter intracardiac procedures.**

(a) *Identification.* This device is a single use percutaneous catheter system that has (a) blood filter(s) at the distal end. This device is indicated for use while performing transcatheter intracardiac procedures. The device is used to filter blood in a manner that may prevent embolic material (thrombus/debris) from the transcatheter intracardiac procedure from traveling towards the cerebral circulation.

(b) *Classification.* Class II (special controls). The special controls for this device are:

(1) Non-clinical performance testing must demonstrate that the device performs as intended under anticipated conditions of use. The following performance characteristics must be tested:

(i) Simulated-use testing in a clinically relevant bench anatomic model to assess the following:

(A) Delivery, deployment, and retrieval, including quantifying deployment and retrieval forces, and procedural time; and

(B) Device compatibility and lack of interference with the transcatheter intracardiac procedure and device.

(ii) Tensile strengths of joints and components, tip flexibility, torque strength, torque response, and kink resistance.

(iii) Flow characteristics.

(A) The ability of the filter to not impede blood flow.

(B) The amount of time the filter can be deployed in position and/or retrieved from its location without disrupting blood flow.

(iv) Characterization and verification of all dimensions.

(2) Animal testing must demonstrate that the device performs as intended under anticipated conditions of use. The following performance characteristics must be assessed:

(i) Delivery, deployment, and retrieval, including quantifying procedural time.

(ii) Device compatibility and lack of interference with the transcatheter intracardiac procedure and device.

(iii) Flow characteristics.

(A) The ability of the filter to not impede blood flow.

(B) The amount of time the filter can be deployed in position and/or retrieved from its location without disrupting blood flow.

(iv) Gross pathology and histopathology assessing vascular injury and downstream embolization.

(3) All patient contacting components of the device must be demonstrated to be biocompatible.

(4) Performance data must demonstrate the sterility of the device components intended to be provided sterile.

(5) Performance data must support the shelf life of the device by demonstrating continued sterility, package integrity, and device functionality over the identified shelf life.

(6) Labeling for the device must include:

(i) Instructions for use;

(ii) Compatible transcatheter intracardiac procedure devices;

(iii) A detailed summary of the clinical testing conducted; and

(iv) A shelf life and storage conditions.

(7) Clinical performance testing must demonstrate:

(i) The ability to safely deliver, deploy, and remove the device;

(ii) The ability of the device to filter embolic material while not impeding blood flow;

(iii) Secure positioning and stability of the position throughout the transcatheter intracardiac procedure; and

(iv) Evaluation of all adverse events including death, stroke, and vascular injury.

[83 FR 4140, Jan. 30, 2018]

**§ 870.1255 Balloon aortic valvuloplasty catheter.**

(a) *Identification.* A balloon aortic valvuloplasty catheter is a catheter with a balloon at the distal end of the shaft, which is intended to treat stenosis in the aortic valve when the balloon is expanded.

(b) *Classification.* Class II (special controls). The special controls for this device are:

(1) The device must be demonstrated to be biocompatible.



(2) Sterility and shelf life testing must demonstrate the sterility of patient-contacting components and the shelf life of these components.

(3) Non-clinical performance evaluation must demonstrate that the device performs as intended under anticipated conditions of use, including device delivery, inflation, deflation, and removal.

(4) In vivo evaluation of the device must demonstrate device performance, including the ability of the device to treat aortic stenosis.

(5) Labeling must include a detailed summary of the device-related and procedure-related complications pertinent to the use of the device.

[82 FR 34852, July 27, 2017]

**§ 870.1270 Intracavitary phonocatheter system.**

(a) *Identification.* An intracavitary phonocatheter system is a system that includes a catheter with an acoustic transducer and the associated device that processes the signal from the transducer; this device records bioacoustic phenomena from a transducer placed within the heart, blood vessels, or body cavities.

(b) *Classification.* Class II (performance standards).

**§ 870.1280 Steerable catheter.**

(a) *Identification.* A steerable catheter is a catheter used for diagnostic and monitoring purposes whose movements are directed by a steering control unit.

(b) *Classification.* Class II (performance standards).

**§ 870.1290 Steerable catheter control system.**

(a) *Identification.* A steerable catheter control system is a device that is connected to the proximal end of a steerable guide wire that controls the motion of the steerable catheter.

(b) *Classification.* Class II (performance standards).

**§ 870.1300 Catheter cannula.**

(a) *Identification.* A catheter cannula is a hollow tube which is inserted into a vessel or cavity; this device provides a rigid or semirigid structure which can be connected to a tube or connector.

(b) *Classification.* Class II (performance standards).

**§ 870.1310 Vessel dilator for percutaneous catheterization.**

(a) *Identification.* A vessel dilator for percutaneous catheterization is a device which is placed over the guide wire to enlarge the opening in the vessel, and which is then removed before sliding the catheter over the guide wire.

(b) *Classification.* Class II (performance standards).

**§ 870.1330 Catheter guide wire.**

(a) *Identification.* A catheter guide wire is a coiled wire that is designed to fit inside a percutaneous catheter for the purpose of directing the catheter through a blood vessel.

(b) *Classification.* Class II (special controls). The device, when it is a torque device that is manually operated, non-patient contacting, and intended to manipulate non-cerebral vascular guide wires, is exempt from the premarket notification procedures in subpart E of part 807 of this chapter subject to the limitations in § 870.9.

[45 FR 7907, Feb. 5, 1980, as amended at 84 FR 71811, Dec. 30, 2019]

**§ 870.1340 Catheter introducer.**

(a) *Identification.* A catheter introducer is a sheath used to facilitate placing a catheter through the skin into a vein or artery.

(b) *Classification.* Class II (performance standards).

**§ 870.1350 Catheter balloon repair kit.**

(a) *Identification.* A catheter balloon repair kit is a device used to repair or replace the balloon of a balloon catheter. The kit contains the materials, such as glue and balloons, necessary to effect the repair or replacement.

(b) *Classification.* Class III (premarket approval).

(c) *Date PMA or notice of completion of a PDP is required.* A PMA or notice of completion of a PDP is required to be filed with the Food and Drug Administration on or before December 26, 1996 for any catheter balloon repair kit that was in commercial distribution before May 28, 1976, or that has, on or before

## § 870.1360

December 26, 1996 been found to be substantially equivalent to a catheter balloon repair kit that was in commercial distribution before May 28, 1976. Any other catheter balloon repair kit shall have an approved PMA or a declared completed PDP in effect before being placed in commercial distribution.

[45 FR 7907, Feb. 5, 1980, as amended at 52 FR 17736, May 11, 1987; 61 FR 50706, Sept. 27, 1996]

### § 870.1360 Trace microsphere.

(a) *Identification.* A trace microsphere is a radioactively tagged nonbiodegradable particle that is intended to be injected into an artery or vein and trapped in the capillary bed for the purpose of studying blood flow within or to an organ.

(b) *Classification.* Class III (premarket approval).

(c) *Date PMA or notice of completion of a PDP is required.* A PMA or notice of completion of a PDP is required to be filed with the Food and Drug Administration on or before December 26, 1996 for any trace microsphere that was in commercial distribution before May 28, 1976, or that has, on or before December 26, 1996 been found to be substantially equivalent to a trace microsphere that was in commercial distribution before May 28, 1976. Any other trace microsphere shall have an approved PMA or a declared completed PDP in effect before being placed in commercial distribution.

[45 FR 7907, Feb. 5, 1980, as amended at 52 FR 17736, May 11, 1987; 61 FR 50706, Sept. 27, 1996]

### § 870.1370 Catheter tip occluder.

(a) *Identification.* A catheter tip occluder is a device that is inserted into certain catheters to prevent flow through one or more orifices.

(b) *Classification.* Class II (performance standards).

### § 870.1380 Catheter stylet.

(a) *Identification.* A catheter stylet is a wire that is run through a catheter or cannula to render it stiff.

(b) *Classification.* Class II (performance standards).

### § 870.1390 Trocar.

(a) *Identification.* A trocar is a sharp-pointed instrument used with a

## 21 CFR Ch. I (4–1–20 Edition)

cannula for piercing a vessel or chamber to facilitate insertion of the cannula.

(b) *Classification.* Class II (special controls). Except for trocars that are reprocessed for multiple use, the device is exempt from the premarket notification procedures in subpart E of part 807 of this chapter subject to the limitations in § 870.9.

[45 FR 7907, Feb. 5, 1980, as amended at 84 FR 71811, Dec. 30, 2019]

### § 870.1415 Coronary vascular physiologic simulation software device.

(a) *Identification.* A coronary vascular physiologic simulation software device is a prescription device that provides simulated functional assessment of blood flow in the coronary vascular system using data extracted from medical device imaging to solve algorithms and yield simulated metrics of physiologic information (*e.g.*, blood flow, coronary flow reserve, fractional flow reserve, myocardial perfusion). A coronary vascular physiologic simulation software device is intended to generate results for use and review by a qualified clinician.

(b) *Classification.* Class II (special controls). The special controls for this device are:

(1) Adequate software verification and validation based on comprehensive hazard analysis, with identification of appropriate mitigations, must be performed, including:

(i) Full characterization of the technical parameters of the software, including:

(A) Any proprietary algorithm(s) used to model the vascular anatomy; and

(B) Adequate description of the expected impact of all applicable image acquisition hardware features and characteristics on performance and any associated minimum specifications;

(ii) Adequate consideration of privacy and security issues in the system design; and

(iii) Adequate mitigation of the impact of failure of any subsystem components (*e.g.*, signal detection and analysis, data storage, system communications and cybersecurity) with respect to incorrect patient reports and operator failures.

(2) Adequate non-clinical performance testing must be provided to demonstrate the validity of computational modeling methods for flow measurement; and

(3) Clinical data supporting the proposed intended use must be provided, including the following:

(i) Output measure(s) must be compared to a clinically acceptable method and must adequately represent the simulated measure(s) the device provides in an accurate and reproducible manner;

(ii) Clinical utility of the device measurement accuracy must be demonstrated by comparison to that of other available diagnostic tests (*e.g.*, from literature analysis);

(iii) Statistical performance of the device within clinical risk strata (*e.g.*, age, relevant comorbidities, disease stability) must be reported;

(iv) The dataset must be adequately representative of the intended use population for the device (*e.g.*, patients, range of vessel sizes, imaging device models). Any selection criteria or limitations of the samples must be fully described and justified;

(v) Statistical methods must consider the predefined endpoints:

(A) Estimates of probabilities of incorrect results must be provided for each endpoint,

(B) Where multiple samples from the same patient are used, statistical analysis must not assume statistical independence without adequate justification, and

(C) The report must provide appropriate confidence intervals for each performance metric;

(vi) Sensitivity and specificity must be characterized across the range of available measurements;

(vii) Agreement of the simulated measure(s) with clinically acceptable measure(s) must be assessed across the full range of measurements;

(viii) Comparison of the measurement performance must be provided across the range of intended image acquisition hardware; and

(ix) If the device uses a cutoff threshold or operates across a spectrum of disease, it must be established prior to validation, and it must be justified as

to how it was determined and clinically validated;

(4) Adequate validation must be performed and controls implemented to characterize and ensure consistency (*i.e.*, repeatability and reproducibility) of measurement outputs:

(i) Acceptable incoming image quality control measures and the resulting image rejection rate for the clinical data must be specified, and

(ii) Data must be provided within the clinical validation study or using equivalent datasets demonstrating the consistency (*i.e.*, repeatability and reproducibility) of the output that is representative of the range of data quality likely to be encountered in the intended use population and relevant use conditions in the intended use environment;

(A) Testing must be performed using multiple operators meeting planned qualification criteria and using the procedure that will be implemented in the production use of the device, and

(B) The factors (*e.g.*, medical imaging dataset, operator) must be identified regarding which were held constant and which were varied during the evaluation, and a description must be provided for the computations and statistical analyses used to evaluate the data;

(5) Human factors evaluation and validation must be provided to demonstrate adequate performance of the user interface to allow for users to accurately measure intended parameters, particularly where parameter settings that have impact on measurements require significant user intervention; and

(6) Device labeling must be provided that adequately describes the following:

(i) The device's intended use, including the type of imaging data used, what the device measures and outputs to the user, whether the measure is qualitative or quantitative, the clinical indications for which it is to be used, and the specific population for which the device use is intended;

(ii) Appropriate warnings specifying the intended patient population, identifying anatomy and image acquisition factors that may impact measurement

**§ 870.1425**

results, and providing cautionary guidance for interpretation of the provided measurements;

(iii) Key assumptions made in the calculation and determination of simulated measurements;

(iv) The measurement performance of the device for all presented parameters, with appropriate confidence intervals, and the supporting evidence for this performance. Per-vessel clinical performance, including where applicable localized performance according to vessel and segment, must be included as well as a characterization of the measurement error across the expected range of measurement for key parameters based on the clinical data;

(v) A detailed description of the patients studied in the clinical validation (*e.g.*, age, gender, race or ethnicity, clinical stability, current treatment regimen) as well as procedural details of the clinical study (*e.g.*, scanner representation, calcium scores, use of beta-blockers or nitrates); and

(vi) Where significant human interface is necessary for accurate analysis, adequately detailed description of the analysis procedure using the device and any data features that could affect accuracy of results.

[80 FR 63673, Oct. 21, 2015]

**§ 870.1425 Programmable diagnostic computer.**

(a) *Identification.* A programmable diagnostic computer is a device that can be programmed to compute various physiologic or blood flow parameters based on the output from one or more electrodes, transducers, or measuring devices; this device includes any associated commercially supplied programs.

(b) *Classification.* Class II (performance standards).

**§ 870.1435 Single-function, preprogrammed diagnostic computer.**

(a) *Identification.* A single-function, preprogrammed diagnostic computer is a hard-wired computer that calculates a specific physiological or blood-flow parameter based on information obtained from one or more electrodes, transducers, or measuring devices.

**21 CFR Ch. I (4–1–20 Edition)**

(b) *Classification.* Class II (performance standards).

**§ 870.1450 Densitometer.**

(a) *Identification.* A densitometer is a device used to measure the transmission of light through an indicator in a sample of blood.

(b) *Classification.* Class II (performance standards).

**§ 870.1650 Angiographic injector and syringe.**

(a) *Identification.* An angiographic injector and syringe is a device that consists of a syringe and a high-pressure injector which are used to inject contrast material into the heart, great vessels, and coronary arteries to study the heart and vessels by x-ray photography.

(b) *Classification.* Class II (special controls). The device, when it is a non-patient contacting balloon inflation syringe intended only to inflate/deflate balloon catheters and monitor pressure within the balloon, is exempt from the premarket notification procedures in subpart E of part 807 of this chapter subject to the limitations in § 870.9.

[45 FR 7907, Feb. 5, 1980, as amended at 84 FR 71811, Dec. 30, 2019]

**§ 870.1660 Indicator injector.**

(a) *Identification.* An indicator injector is an electrically or gas-powered device designed to inject accurately an indicator solution into the blood stream. This device may be used in conjunction with a densitometer or thermodilution device to determine cardiac output.

(b) *Classification.* Class II (performance standards).

**§ 870.1670 Syringe actuator for an injector.**

(a) *Identification.* A syringe actuator for an injector is an electrical device that controls the timing of an injection by an angiographic or indicator injector and synchronizes the injection with the electrocardiograph signal.

(b) *Classification.* Class II (performance standards).

**§ 870.1750 External programmable pacemaker pulse generator.**

(a) *Identification.* An external programmable pacemaker pulse generator is a device that can be programmed to produce one or more pulses at preselected intervals; this device is used in electrophysiological studies.

(b) *Classification.* Class II (performance standards).

**§ 870.1800 Withdrawal-infusion pump.**

(a) *Identification.* A withdrawal-infusion pump is a device designed to inject accurately drugs into the bloodstream and to withdraw blood samples for use in determining cardiac output.

(b) *Classification.* Class II (performance standards).

**§ 870.1875 Stethoscope.**

(a) *Manual stethoscope—(1) Identification.* A manual stethoscope is a mechanical device used to project the sounds associated with the heart, arteries, and veins and other internal organs.

(2) *Classification.* Class I (general controls). The device is exempt from the premarket notification procedures in subpart E of part 807 of this chapter subject to the limitations in § 870.9.

(b) *Electronic stethoscope—(1) Identification.* An electronic stethoscope is an electrically amplified device used to project the sounds associated with the heart, arteries, and veins and other internal organs.

(2) *Classification.* Class II (special controls). The device, when it is a lung sound monitor, is exempt from the premarket notification procedures in subpart E of part 807 of this chapter subject to the limitations in § 870.9.

[45 FR 7907, Feb. 5, 1980, as amended at 59 FR 63007, Dec. 7, 1994; 66 FR 38796, July 25, 2001; 84 FR 71811, Dec. 30, 2019]

**§ 870.1915 Thermodilution probe.**

(a) *Identification.* A thermodilution probe is a device that monitors cardiac output by use of thermodilution techniques; this device is commonly attached to a catheter that may have one or more probes.

(b) *Classification.* Class II (performance standards).

**Subpart C—Cardiovascular Monitoring Devices****§ 870.2050 Biopotential amplifier and signal conditioner.**

(a) *Identification.* A biopotential amplifier and signal conditioner is a device used to amplify or condition an electrical signal of biologic origin.

(b) *Classification.* Class II (performance standards).

**§ 870.2060 Transducer signal amplifier and conditioner.**

(a) *Identification.* A transducer signal amplifier and conditioner is a device used to provide the excitation energy for the transducer and to amplify or condition the signal emitted by the transducer.

(b) *Classification.* Class II (performance standards).

**§ 870.2100 Cardiovascular blood flowmeter.**

(a) *Identification.* A cardiovascular blood flowmeter is a device that is connected to a flow transducer that energizes the transducer and processes and displays the blood flow signal.

(b) *Classification.* Class II (performance standards).

**§ 870.2120 Extravascular blood flow probe.**

(a) *Identification.* An extravascular blood flow probe is an extravascular ultrasonic or electromagnetic probe used in conjunction with a blood flowmeter to measure blood flow in a chamber or vessel.

(b) *Classification.* Class II (performance standards).

**§ 870.2200 Adjunctive cardiovascular status indicator.**

(a) *Identification.* The adjunctive cardiovascular status indicator is a prescription device based on sensor technology for the measurement of a physical parameter(s). This device is intended for adjunctive use with other physical vital sign parameters and patient information and is not intended to independently direct therapy.

(b) *Classification.* Class II (special controls). The special controls for this device are:

§ 870.2300

21 CFR Ch. I (4–1–20 Edition)

(1) Software description, verification, and validation based on comprehensive hazard analysis must be provided, including:

(i) Full characterization of technical parameters of the software, including any proprietary algorithm(s);

(ii) Description of the expected impact of all applicable sensor acquisition hardware characteristics on performance and any associated hardware specifications;

(iii) Specification of acceptable incoming sensor data quality control measures; and

(iv) Mitigation of impact of user error or failure of any subsystem components (signal detection and analysis, data display, and storage) on accuracy of patient reports.

(2) Scientific justification for the validity of the status indicator algorithm(s) must be provided. Verification of algorithm calculations and validation testing of the algorithm using a data set separate from the training data must demonstrate the validity of modeling.

(3) Usability assessment must be provided to demonstrate that risk of misinterpretation of the status indicator is appropriately mitigated.

(4) Clinical data must be provided in support of the intended use and include the following:

(i) Output measure(s) must be compared to an acceptable reference method to demonstrate that the output measure(s) represent(s) the predictive measure(s) that the device provides in an accurate and reproducible manner;

(ii) The data set must be representative of the intended use population for the device. Any selection criteria or limitations of the samples must be fully described and justified;

(iii) Agreement of the measure(s) with the reference measure(s) must be assessed across the full measurement range; and

(iv) Data must be provided within the clinical validation study or using equivalent datasets to demonstrate the consistency of the output and be representative of the range of data sources and data quality likely to be encountered in the intended use population and relevant use conditions in the intended use environment.

(5) Labeling must include the following:

(i) The type of sensor data used, including specification of compatible sensors for data acquisition;

(ii) A description of what the device measures and outputs to the user;

(iii) Warnings identifying sensor reading acquisition factors that may impact measurement results;

(iv) Guidance for interpretation of the measurements, including warning(s) specifying adjunctive use of the measurements;

(v) Key assumptions made in the calculation and determination of measurements;

(vi) The measurement performance of the device for all presented parameters, with appropriate confidence intervals, and the supporting evidence for this performance; and

(vii) A detailed description of the patients studied in the clinical validation (*e.g.*, age, gender, race/ethnicity, clinical stability) as well as procedural details of the clinical study.

[82 FR 35067, July 28, 2017]

**§ 870.2300 Cardiac monitor (including cardi tachometer and rate alarm).**

(a) *Identification.* A cardiac monitor (including cardi tachometer and rate alarm) is a device used to measure the heart rate from an analog signal produced by an electrocardiograph, vectorcardiograph, or blood pressure monitor. This device may sound an alarm when the heart rate falls outside preset upper and lower limits.

(b) *Classification.* Class II (performance standards).

**§ 870.2310 Apex cardiograph (vibrocardiograph).**

(a) *Identification.* An apex cardiograph (vibrocardiograph) is a device used to amplify or condition the signal from an apex cardiographic transducer and to produce a visual display of the motion of the heart; this device also provides any excitation energy required by the transducer.

(b) *Classification.* Class II (performance standards).

**§ 870.2320 Ballistocardiograph.**

(a) *Identification.* A ballistocardiograph is a device, including a supporting structure on which the patient is placed, that moves in response to blood ejection from the heart. The device often provides a visual display.

(b) *Classification.* Class II (performance standards).

**§ 870.2330 Echocardiograph.**

(a) *Identification.* An echocardiograph is a device that uses ultrasonic energy to create images of cardiovascular structures. It includes phased arrays and two-dimensional scanners.

(b) *Classification.* Class II (performance standards).

**§ 870.2340 Electrocardiograph.**

(a) *Identification.* An electrocardiograph is a device used to process the electrical signal transmitted through two or more electrocardiograph electrodes and to produce a visual display of the electrical signal produced by the heart.

(b) *Classification.* Class II (performance standards).

**§ 870.2350 Electrocardiograph lead switching adaptor.**

(a) *Identification.* An electrocardiograph lead switching adaptor is a passive switching device to which electrocardiograph limb and chest leads may be attached. This device is used to connect various combinations of limb and chest leads to the output terminals in order to create standard lead combinations such as leads I, II, and III.

(b) *Classification.* Class II (performance standards).

**§ 870.2360 Electrocardiograph electrode.**

(a) *Identification.* An electrocardiograph electrode is the electrical conductor which is applied to the surface of the body to transmit the electrical signal at the body surface to a processor that produces an electrocardiogram or vectorcardiogram.

(b) *Classification.* Class II (special controls). The device is exempt from the premarket notification procedures in subpart E of part 807 of this chapter subject to the limitations in § 870.9. The

special control for this device is the FDA guidance document entitled “Class II Special Controls Guidance Document: Electrocardiograph Electrodes.” See § 870.1(e) for availability information of guidance documents.

[45 FR 7907, Feb. 5, 1980, as amended at 76 FR 43585, July 21, 2011]

**§ 870.2370 Electrocardiograph surface electrode tester.**

(a) *Identification.* An electrocardiograph surface electrode tester is a device used to test the function and application of electrocardiograph electrodes.

(b) *Classification.* Class II (performance standards).

**§ 870.2390 Phonocardiograph.**

(a) *Identification.* A phonocardiograph is a device used to amplify or condition the signal from a heart sound transducer. This device furnishes the excitation energy for the transducer and provides a visual or audible display of the heart sounds.

(b) *Classification.* Class I (general controls). The device is exempt from the premarket notification procedures in subpart E of part 807 of this chapter subject to the limitations in § 870.9.

[45 FR 7907, Feb. 5, 1980, as amended at 61 FR 1121, Jan. 16, 1996; 66 FR 38796, July 25, 2001]

**§ 870.2400 Vectorcardiograph.**

(a) *Identification.* A vectorcardiograph is a device used to process the electrical signal transmitted through electrocardiograph electrodes and to produce a visual display of the magnitude and direction of the electrical signal produced by the heart.

(b) *Classification.* Class II (performance standards).

**§ 870.2450 Medical cathode-ray tube display.**

(a) *Identification.* A medical cathode-ray tube display is a device designed primarily to display selected biological signals. This device often incorporates special display features unique to a specific biological signal.

(b) *Classification.* Class II (performance standards).

## § 870.2600

## 21 CFR Ch. I (4–1–20 Edition)

### § 870.2600 Signal isolation system.

(a) *Identification.* A signal isolation system is a device that electrically isolates the patient from equipment connected to the commercial power supply received from a utility company. This isolation may be accomplished, for example, by transformer coupling, acoustic coupling, or optical coupling.

(b) *Classification.* Class I (general controls). The device is exempt from the premarket notification procedures in subpart E of part 807 of this chapter subject to the limitations in § 870.9.

[45 FR 7907, Feb. 5, 1980, as amended at 61 FR 1121, Jan. 16, 1996; 66 FR 38796, July 25, 2001]

### § 870.2620 Line isolation monitor.

(a) *Identification.* A line isolation monitor is a device used to monitor the electrical leakage current from a power supply electrically isolated from the commercial power supply received from a utility company.

(b) *Classification.* Class I (general controls). The device is exempt from the premarket notification procedures in subpart E of part 807 of this chapter subject to the limitations in § 870.9.

[45 FR 7907, Feb. 5, 1980, as amended at 61 FR 1121, Jan. 16, 1996; 66 FR 38796, July 25, 2001]

### § 870.2640 Portable leakage current alarm.

(a) *Identification.* A portable leakage current alarm is a device used to measure the electrical leakage current between any two points of an electrical system and to sound an alarm if the current exceeds a certain threshold.

(b) *Classification.* Class I (general controls). The device is exempt from the premarket notification procedures in subpart E of part 807 of this chapter subject to the limitations in § 870.9.

[45 FR 7907, Feb. 5, 1980, as amended at 61 FR 1121, Jan. 16, 1996; 66 FR 38796, July 25, 2001]

### § 870.2675 Oscillometer.

(a) *Identification.* An oscillometer is a device used to measure physiological oscillations of any kind, e.g., changes in the volume of arteries.

(b) *Classification.* Class II (special controls). The device is exempt from the premarket notification procedures

in subpart E of part 807 of this chapter subject to the limitations in § 870.9.

[45 FR 7907, Feb. 5, 1980, as amended at 84 FR 71812, Dec. 30, 2019]

### § 870.2700 Oximeter.

(a) *Identification.* An oximeter is a device used to transmit radiation at a known wavelength(s) through blood and to measure the blood oxygen saturation based on the amount of reflected or scattered radiation. It may be used alone or in conjunction with a fiberoptic oximeter catheter.

(b) *Classification.* Class II (performance standards).

### § 870.2710 Ear oximeter.

(a) *Identification.* An ear oximeter is an extravascular device used to transmit light at a known wavelength(s) through blood in the ear. The amount of reflected or scattered light as indicated by this device is used to measure the blood oxygen saturation.

(b) *Classification.* Class II (performance standards).

### § 870.2750 Impedance phlebograph.

(a) *Identification.* An impedance phlebograph is a device used to provide a visual display of the venous pulse or drainage by measuring electrical impedance changes in a region of the body.

(b) *Classification.* Class II (performance standards).

### § 870.2770 Impedance plethysmograph.

(a) *Identification.* An impedance plethysmograph is a device used to estimate peripheral blood flow by measuring electrical impedance changes in a region of the body such as the arms and legs.

(b) *Classification.* Class II (special controls). The device, when it is a body composition analyzer which is not intended to diagnose or treat any medical condition, is exempt from the premarket notification procedures in subpart E of part 807 of this chapter subject to the limitations in § 870.9.

[45 FR 7907, Feb. 5, 1980, as amended at 84 FR 71812, Dec. 30, 2019]



**Food and Drug Administration, HHS**

**§ 870.2880**

**§ 870.2780 Hydraulic, pneumatic, or photoelectric plethysmographs.**

(a) *Identification.* A hydraulic, pneumatic, or photoelectric plethysmograph is a device used to estimate blood flow in a region of the body using hydraulic, pneumatic, or photoelectric measurement techniques.

(b) *Classification.* Class II (performance standards).

**§ 870.2800 Medical magnetic tape recorder.**

(a) *Identification.* A medical magnetic tape recorder is a device used to record and play back signals from, for example, physiological amplifiers, signal conditioners, or computers.

(b) *Classification.* Class II (performance standards).

**§ 870.2810 Paper chart recorder.**

(a) *Identification.* A paper chart recorder is a device used to print on paper, and create a permanent record of the signal from, for example, a physiological amplifier, signal conditioner, or computer.

(b) *Classification.* Class I (general controls). The device is exempt from the premarket notification procedures in subpart E of part 807 of this chapter subject to the limitations in § 870.9.

[45 FR 7907, Feb. 5, 1980, as amended at 61 FR 1121, Jan. 16, 1996; 66 FR 38796, July 25, 2001]

**§ 870.2840 Apex cardiographic transducer.**

(a) *Identification.* An apex cardiographic transducer is a device used to detect motion of the heart (acceleration, velocity, or displacement) by changes in the mechanical or electrical properties of the device.

(b) *Classification.* Class II (performance standards).

**§ 870.2850 Extravascular blood pressure transducer.**

(a) *Identification.* An extravascular blood pressure transducer is a device used to measure blood pressure by changes in the mechanical or electrical properties of the device. The proximal end of the transducer is connected to a pressure monitor that produces an analog or digital electrical signal related

to the electrical or mechanical changes produced in the transducer.

(b) *Classification.* Class II (performance standards).

**§ 870.2855 Implantable Intra-aneurysm Pressure Measurement System.**

(a) *Identification.* Implantable intra-aneurysm pressure measurement system is a device used to measure the intra-sac pressure in a vascular aneurysm. The device consists of a pressure transducer that is implanted into the aneurysm and a monitor that reads the pressure from the transducer.

(b) *Classification.* Class II (special controls). The special control is FDA's guidance document entitled "Class II Special Controls Guidance Document: Implantable Intra-Aneurysm Pressure Measurement System." See § 870.1 (e) for the availability of this guidance document.

[71 FR 7871, Feb. 15, 2006]

**§ 870.2860 Heart sound transducer.**

(a) *Identification.* A heart sound transducer is an external transducer that exhibits a change in mechanical or electrical properties in relation to sounds produced by the heart. This device may be used in conjunction with a phonocardiograph to record heart sounds.

(b) *Classification.* Class II (performance standards).

**§ 870.2870 Catheter tip pressure transducer.**

(a) *Identification.* A catheter tip pressure transducer is a device incorporated into the distal end of a catheter. When placed in the bloodstream, its mechanical or electrical properties change in relation to changes in blood pressure. These changes are transmitted to accessory equipment for processing.

(b) *Classification.* Class II (performance standards).

**§ 870.2880 Ultrasonic transducer.**

(a) *Identification.* An ultrasonic transducer is a device applied to the skin to transmit and receive ultrasonic energy that is used in conjunction with an echocardiograph to provide imaging of cardiovascular structures. This device

**§ 870.2890**

includes phased arrays and two-dimensional scanning transducers.

(b) *Classification.* Class II (performance standards).

**§ 870.2890 Vessel occlusion transducer.**

(a) *Identification.* A vessel occlusion transducer is a device used to provide an electrical signal corresponding to sounds produced in a partially occluded vessel. This device includes motion, sound, and ultrasonic transducers.

(b) *Classification.* Class II (performance standards).

**§ 870.2900 Patient transducer and electrode cable (including connector).**

(a) *Identification.* A patient transducer and electrode cable (including connector) is an electrical conductor used to transmit signals from, or power or excitation signals to, patient-connected electrodes or transducers.

(b) *Classification.* Class II (performance standards).

**§ 870.2910 Radiofrequency physiological signal transmitter and receiver.**

(a) *Identification.* A radiofrequency physiological signal transmitter and receiver is a device used to condition a physiological signal so that it can be transmitted via radiofrequency from one location to another, e.g., a central monitoring station. The received signal is reconditioned by the device into its original format so that it can be displayed.

(b) *Classification.* Class II (performance standards).

**§ 870.2920 Telephone electrocardiograph transmitter and receiver.**

(a) *Identification.* A telephone electrocardiograph transmitter and receiver is a device used to condition an electrocardiograph signal so that it can be transmitted via a telephone line to another location. This device also includes a receiver that reconditions the received signal into its original format so that it can be displayed. The device includes devices used to transmit and receive pacemaker signals.

(b) *Classification.* Class II (performance standards).

**21 CFR Ch. I (4–1–20 Edition)**

**Subpart D—Cardiovascular Prosthetic Devices**

**§ 870.3250 Vascular clip.**

(a) *Identification.* A vascular clip is an implanted extravascular device designed to occlude, by compression, blood flow in small blood vessels other than intracranial vessels.

(b) *Classification.* Class II (performance standards).

**§ 870.3260 Vena cava clip.**

(a) *Identification.* A vena cava clip is an implanted extravascular device designed to occlude partially the vena cava for the purpose of inhibiting the flow of thromboemboli through that vessel.

(b) *Classification.* Class II (performance standards).

**§ 870.3300 Vascular embolization device.**

(a) *Identification.* A vascular embolization device is an intravascular implant intended to control hemorrhaging due to aneurysms, certain types of tumors (e.g., nephroma, hepatoma, uterine fibroids), and arteriovenous malformations. This does not include cyanoacrylates and other embolic agents, which act by polymerization or precipitation. Embolization devices used in neurovascular applications are also not included in this classification, see § 882.5950 of this chapter.

(b) *Classification.* Class II (special controls.) The special control for this device is the FDA guidance document entitled “Class II Special Controls Guidance Document: Vascular and Neurovascular Embolization Devices.” For availability of this guidance document, see § 870.1(e).

[69 FR 77899, Dec. 29, 2004]

**§ 870.3375 Cardiovascular intravascular filter.**

(a) *Identification.* A cardiovascular intravascular filter is an implant that is placed in the inferior vena cava for the purpose of preventing pulmonary thromboemboli (blood clots generated in the lower limbs and broken loose into the blood stream) from flowing

into the right side of the heart and the pulmonary circulation.

(b) *Classification*. Class II. The special controls for this device are:

(1) "Use of International Standards Organization's ISO 10993 'Biological Evaluation of Medical Devices Part I: Evaluation and Testing,'" and

(2) FDA's:

(i) "510(k) Sterility Review Guidance and Revision of 2/12/90 (K90-1)" and

(ii) "Guidance for Cardiovascular Intravascular Filter 510(k) Submissions."

[45 FR 7907, Feb. 5, 1980, as amended at 52 FR 17736, May 11, 1987; 65 FR 17144, Mar. 31, 2000]

#### § 870.3450 Vascular graft prosthesis.

(a) *Identification*. A vascular graft prosthesis is an implanted device intended to repair, replace, or bypass sections of native or artificial vessels, excluding coronary or cerebral vasculature, and to provide vascular access. It is commonly constructed of materials such as polyethylene terephthalate and polytetrafluoroethylene, and it may be coated with a biological coating, such as albumin or collagen, or a synthetic coating, such as silicone. The graft structure itself is not made of materials of animal origin, including human umbilical cords.

(b) *Classification*. Class II (special controls). The special control for this device is the FDA guidance document entitled "Guidance Document for Vascular Prostheses 510(k) Submissions."

[66 FR 18542, Apr. 10, 2001]

#### § 870.3460 Endovascular Suturing System.

(a) *Identification*. An endovascular suturing system is a medical device intended to provide fixation and sealing between an endovascular graft and the native artery. The system is comprised of the implant device and an endovascular delivery device used to implant the endovascular suture.

(b) *Classification*. Class II (special controls). The special controls for this device are:

(1) The device should be demonstrated to be biocompatible;

(2) Sterility and shelf life testing should demonstrate the sterility of pa-

tient-contacting components and the shelf-life of these components;

(3) Non-clinical and clinical performance testing should demonstrate substantial equivalence in safety and effectiveness, including durability, compatibility, migration resistance, corrosion resistance, and delivery and deployment;

(4) Non-clinical testing should evaluate the compatibility of the device in an magnetic resonance (MR) environment;

(5) Appropriate analysis and non-clinical testing should validate electromagnetic compatibility (EMC) and electrical safety;

(6) The sale, distribution, and use of the device are restricted to prescription use in accordance with 21 CFR 801.109 of this chapter; and

(7) Labeling must bear all information required for the safe and effective use of the device as outlined in § 801.109(c) of this chapter, including a detailed summary of the non-clinical and clinical evaluations pertinent to use of the device.

[77 FR 8119, Feb. 14, 2012]

#### § 870.3470 Intracardiac patch or pledget made of polypropylene, polyethylene terephthalate, or polytetrafluoroethylene.

(a) *Identification*. An intracardiac patch or pledget made of polypropylene, polyethylene terephthalate, or polytetrafluoroethylene is a fabric device placed in the heart that is used to repair septal defects, for patch grafting, to repair tissue, and to buttress sutures.

(b) *Classification*. Class II (performance standards).

#### § 870.3535 Intra-aortic balloon and control system.

(a) *Identification*. An intra-aortic balloon and control system is a prescription device that consists of an inflatable balloon, which is placed in the aorta to improve cardiovascular functioning during certain life-threatening emergencies, and a control system for regulating the inflation and deflation of the balloon. The control system, which monitors and is synchronized with the electrocardiogram, provides a

**§ 870.3545**

means for setting the inflation and deflation of the balloon with the cardiac cycle.

(b) *Classification.* (1) Class II (special controls) when the device is indicated for acute coronary syndrome, cardiac and non-cardiac surgery, or complications of heart failure. The special controls for this device are:

(i) Appropriate analysis and non-clinical testing must be conducted to validate electromagnetic compatibility and electrical safety of the device;

(ii) Software verification, validation, and hazard analysis must be performed;

(iii) The device must be demonstrated to be biocompatible;

(iv) Sterility and shelf-life testing must demonstrate the sterility of patient-contacting components and the shelf life of these components;

(v) Non-clinical performance evaluation of the device must demonstrate mechanical integrity, durability, and reliability to support its intended purpose; and

(vi) Labeling must include a detailed summary of the device- and procedure-related complications pertinent to use of the device.

(2) Class III (premarket approval) when the device is indicated for septic shock and pulsatile flow generation.

(c) *Date premarket approval application (PMA) or notice of completion of product development protocol (PDP) is required.* A PMA or notice of completion of a PDP is required to be filed with the Food and Drug Administration on or before March 31, 2014, for any intra-aortic balloon and control system indicated for septic shock or pulsatile flow generation that was in commercial distribution before May 28, 1976, or that has, on or before March 31, 2014, been found to be substantially equivalent to any intra-aortic balloon and control system indicated for septic shock or pulsatile flow generation that was in commercial distribution before May 28, 1976. Any other intra-aortic balloon and control system indicated for septic shock or pulsatile flow generation shall have an approved PMA or declared completed PDP in effect before being placed in commercial distribution.

[78 FR 79303, Dec. 31, 2013]

**21 CFR Ch. I (4–1–20 Edition)**

**§ 870.3545 Ventricular bypass (assist) device.**

(a) *Identification.* A ventricular bypass (assist) device is a device that assists the left or right ventricle in maintaining circulatory blood flow. The device is either totally or partially implanted in the body.

(b) *Classification.* Class III (premarket approval).

(c) *Date PMA or notice of completion of PDP is required.* A PMA or notice of completion of a PDP is required to be filed with the Food and Drug Administration on or before November 21, 2011, for any ventricular bypass (assist) device that was in commercial distribution before May 28, 1976, or that has, on or before November 21, 2011, been found to be substantially equivalent to any ventricular bypass (assist) device that was in commercial distribution before May 28, 1976. Any other ventricular bypass (assist) device shall have an approved PMA or declared completed PDP in effect before being placed in commercial distribution.

[45 FR 7907, Feb. 5, 1980, as amended at 52 FR 17736, May 11, 1987; 76 FR 50666, Aug. 16, 2011]

**§ 870.3600 External pacemaker pulse generator.**

(a) *Identification.* An external pacemaker pulse generator (EPPG) is a prescription device that has a power supply and electronic circuits that produce a periodic electrical pulse to stimulate the heart. This device, which is used outside the body, is used as a temporary substitute for the heart's intrinsic pacing system until a permanent pacemaker can be implanted, or to control irregular heartbeats in patients following cardiac surgery or a myocardial infarction. The device may have adjustments for impulse strength, duration, R-wave sensitivity, and other pacing variables.

(b) *Classification.* Class II (special controls). The special controls for this device are:

(1) Appropriate analysis/testing must validate electromagnetic compatibility (EMC) within a hospital environment.

(2) Electrical bench testing must demonstrate device safety during intended use. This must include testing

with the specific power source (*i.e.*, battery power, AC mains connections, or both).

(3) Non-clinical performance testing data must demonstrate the performance characteristics of the device. Testing must include the following:

(i) Testing must demonstrate the accuracy of monitoring functions, alarms, measurement features, therapeutic features, and all adjustable or programmable parameters as identified in labeling;

(ii) Mechanical bench testing of material strength must demonstrate that the device and connection cables will withstand forces or conditions encountered during use;

(iii) Simulated use analysis/testing must demonstrate adequate user interface for adjustable parameters, performance of alarms, display screens, interface with external devices (*e.g.* data storage, printing), and indicator(s) functionality under intended use conditions; and

(iv) Methods and instructions for cleaning the pulse generator and connection cables must be validated.

(4) Appropriate software verification, validation, and hazard analysis must be performed.

(5) Labeling must include the following:

(i) The labeling must clearly state that these devices are intended for use in a hospital environment and under the supervision of a clinician trained in their use;

(ii) Connector terminals should be clearly, unambiguously marked on the outside of the EPPG device. The markings should identify positive (+) and negative (–) polarities. Dual chamber devices should clearly identify atrial and ventricular terminals;

(iii) The labeling must list all pacing modes available in the device;

(iv) Labeling must include a detailed description of any special capabilities (*e.g.*, overdrive pacing or automatic mode switching); and

(v) Appropriate electromagnetic compatibility information must be included.

[81 FR 22529, Apr. 18, 2016]

#### § 870.3605 Pacing system analyzer.

(a) *Identification.* A pacing system analyzer (PSA) is a prescription device that combines the functionality of a pacemaker electrode function tester (§ 870.3720) and an external pacemaker pulse generator (EPPG) (§ 870.3600). It is connected to a pacemaker lead and uses a power supply and electronic circuits to supply an accurately calibrated, variable pacing pulse for measuring the patient's pacing threshold and intracardiac R-wave potential. A PSA may be a single, dual, or triple chamber system and can simultaneously deliver pacing therapy while testing one or more implanted pacing leads.

(b) *Classification.* Class II (special controls). The special controls for this device are:

(1) Appropriate analysis/testing must validate electromagnetic compatibility (EMC) within a hospital environment.

(2) Electrical bench testing must demonstrate device safety during intended use. This must include testing with the specific power source (*i.e.*, battery power, AC mains connections, or both).

(3) Non-clinical performance testing data must demonstrate the performance characteristics of the device. Testing must include the following:

(i) Testing must demonstrate the accuracy of monitoring functions, alarms, measurement features, therapeutic features, and all adjustable or programmable parameters as identified in labeling;

(ii) Mechanical bench testing of material strength must demonstrate that the device and connection cables will withstand forces or conditions encountered during use;

(iii) Simulated use analysis/testing must demonstrate adequate user interface for adjustable parameters, performance of alarms, display screens, interface with external devices (*e.g.* data storage, printing), and indicator(s) functionality under intended use conditions; and

(iv) Methods and instructions for cleaning the pulse generator and connection cables must be validated.

(4) Appropriate software verification, validation, and hazard analysis must be performed.

**§ 870.3610**

**21 CFR Ch. I (4–1–20 Edition)**

(5) Labeling must include the following:

(i) The labeling must clearly state that these devices are intended for use in a hospital environment and under the supervision of a clinician trained in their use;

(ii) Connector terminals should be clearly, unambiguously marked on the outside of the PSA. The markings should identify positive (+) and negative (–) polarities. Dual chamber devices should clearly identify atrial and ventricular terminals. Triple chamber devices should clearly identify atrial, right ventricular, and left ventricular terminals;

(iii) The labeling must list all pacing modes available in the device;

(iv) Labeling must include a detailed description of any special capabilities (e.g., overdrive pacing or automatic mode switching);

(v) Labeling must limit the use of external pacing to the implant procedure; and

(vi) Appropriate electromagnetic compatibility information must be included.

[81 FR 22350, Apr. 18, 2016]

**§ 870.3610 Implantable pacemaker pulse generator.**

(a) *Identification.* An implantable pacemaker pulse generator is a device that has a power supply and electronic circuits that produce a periodic electrical pulse to stimulate the heart. This device is used as a substitute for the heart's intrinsic pacing system to correct both intermittent and continuous cardiac rhythm disorders. This device may include triggered, inhibited, and asynchronous modes and is implanted in the human body.

(b) *Classification.* Class III (premarket approval).

(c) *Date PMA or notice of completion of PDP is required.* A PMA or notice of completion of a PDP is required to be filed with the Food and Drug Administration on or before September 20, 2012, for any implantable pacemaker pulse generator device that was in commercial distribution before May 28, 1976, or that has, on or before September 20, 2012, been found to be substantially equivalent to any implantable pacemaker pulse generator device that was

in commercial distribution before May 28, 1976. Any other implantable pacemaker pulse generator device shall have an approved PMA or declared completed PDP in effect before being placed in commercial distribution.

[45 FR 7907, Feb. 5, 1980, as amended at 52 FR 17736, May 11, 1987; 77 FR 37576, June 22, 2012]

**§ 870.3620 Pacemaker lead adaptor.**

(a) *Identification.* A pacemaker lead adaptor is a device used to adapt a pacemaker lead so that it can be connected to a pacemaker pulse generator produced by a different manufacturer.

(b) *Classification.* Class II (special controls). The special control for this device is the FDA guidance document entitled “Guidance for the Submission of Research and Marketing Applications for Permanent Pacemaker Leads and for Pacemaker Lead Adaptor 510(k) Submissions.”

[45 FR 7907, Feb. 5, 1980, as amended at 52 FR 17736, May 11, 1987; 66 FR 18542, Apr. 10, 2001]

**§ 870.3630 Pacemaker generator function analyzer.**

(a) *Identification.* A pacemaker generator function analyzer is a device that is connected to a pacemaker pulse generator to test any or all of the generator's parameters, including pulse duration, pulse amplitude, pulse rate, and sensing threshold.

(b) *Classification.* Class II (performance standards).

**§ 870.3640 Indirect pacemaker generator function analyzer.**

(a) *Identification.* An indirect pacemaker generator function analyzer is an electrically powered device that is used to determine pacemaker function or pacemaker battery function by periodically monitoring an implanted pacemaker's pulse rate and pulse width. The device is noninvasive, and it detects pacemaker pulse rate and width via external electrodes in contact with the patient's skin.

(b) *Classification.* Class II (performance standards).

**§ 870.3650 Pacemaker polymeric mesh bag.**

(a) *Identification.* A pacemaker polymeric mesh bag is an implanted device

used to hold a pacemaker pulse generator. The bag is designed to create a stable implant environment for the pulse generator.

(b) *Classification*. Class I (general controls). The device is exempt from the premarket notification procedures in subpart E of part 807 of this chapter subject to the limitations in § 870.9.

[45 FR 7907, Feb. 5, 1980, as amended at 61 FR 1121, Jan. 16, 1996; 66 FR 38796, July 25, 2001]

#### § 870.3670 Pacemaker charger.

(a) *Identification*. A pacemaker charger is a device used transcutaneously to recharge the batteries of a rechargeable pacemaker.

(b) *Classification*. Class I (general controls). The device is exempt from the premarket notification procedures in subpart E of part 807 of this chapter subject to the limitations in § 870.9.

[45 FR 7907, Feb. 5, 1980, as amended at 61 FR 1121, Jan. 16, 1996; 66 FR 38796, July 25, 2001]

#### § 870.3680 Cardiovascular permanent or temporary pacemaker electrode.

(a) *Temporary pacemaker electrode*—(1) *Identification*. A temporary pacemaker electrode is a device consisting of flexible insulated electrical conductors with one end connected to an *external* pacemaker pulse generator and the other end applied to the heart. The device is used to transmit a pacing electrical stimulus from the pulse generator to the heart and/or to transmit the electrical signal of the heart to the pulse generator.

(2) *Classification*. Class II (performance standards).

(b) *Permanent pacemaker electrode*—(1) *Identification*. A permanent pacemaker electrode is a device consisting of flexible insulated electrical conductors with one end connected to an implantable pacemaker pulse generator and the other end applied to the heart. The device is used to transmit a pacing electrical stimulus from the pulse generator to the heart and/or to transmit the electrical signal of the heart to the pulse generator.

(2) *Classification*. Class III (premarket approval).

(c) *Date PMA or notice of completion of PDP is required*. A PMA or notice of completion of a PDP is required to be

filed with the Food and Drug Administration on or before October 4, 2012, for any permanent pacemaker electrode device that was in commercial distribution before May 28, 1976, or that has, on or before October 4, 2012, been found to be substantially equivalent to any permanent pacemaker electrode device that was in commercial distribution before May 28, 1976. Any other pacemaker repair or replacement material device shall have an approved PMA or declared completed PDP in effect before being placed in commercial distribution.

[45 FR 7907, Feb. 5, 1980, as amended at 52 FR 17736, May 11, 1987; 77 FR 39927, July 6, 2012]

#### § 870.3690 Pacemaker test magnet.

(a) *Identification*. A pacemaker test magnet is a device used to test an inhibited or triggered type of pacemaker pulse generator and cause an inhibited or triggered generator to revert to asynchronous operation.

(b) *Classification*. Class I (general controls). The device is exempt from the premarket notification procedures in subpart E of part 807 of this chapter subject to the limitations in § 870.9.

[45 FR 7907, Feb. 5, 1980, as amended at 61 FR 1121, Jan. 16, 1996; 66 FR 38796, July 25, 2001]

#### § 870.3700 Pacemaker programmers.

(a) *Identification*. A pacemaker programmer is a device used to noninvasively change one or more of the electrical operating characteristics of a pacemaker.

(b) *Classification*. Class III (premarket approval).

(c) *Date PMA or notice of completion of PDP is required*. A PMA or notice of completion of a PDP is required to be filed with the Food and Drug Administration on or before September 20, 2012, for any pacemaker programmer that was in commercial distribution before May 28, 1976, or that has, on or before September 20, 2012, been found to be substantially equivalent to any pacemaker programmer that was in commercial distribution before May 28, 1976. Any other pacemaker programmer shall have an approved PMA or declared completed PDP in effect before

## § 870.3710

being placed in commercial distribution.

[45 FR 7907, Feb. 5, 1980, as amended at 52 FR 17736, May 11, 1987; 77 FR 37573, June 22, 2012]

### § 870.3710 Pacemaker repair or replacement material.

(a) *Identification.* A pacemaker repair or replacement material is an adhesive, a sealant, a screw, a crimp, or any other material used to repair a pacemaker lead or to reconnect a pacemaker lead to a pacemaker pulse generator.

(b) *Classification.* Class III (premarket approval).

(c) *Date PMA or notice of completion of PDP is required.* A PMA or notice of completion of a PDP is required to be filed with the Food and Drug Administration on or before November 21, 2011, for any pacemaker repair or replacement material device that was in commercial distribution before May 28, 1976, or that has, on or before November 21, 2011, been found to be substantially equivalent to any pacemaker repair or replacement material device that was in commercial distribution before May 28, 1976. Any other pacemaker repair or replacement material device shall have an approved PMA or declared completed PDP in effect before being placed in commercial distribution.

[45 FR 7907, Feb. 5, 1980, as amended at 52 FR 17736, May 11, 1987; 76 FR 50666, Aug. 16, 2011]

### § 870.3720 Pacemaker electrode function tester.

(a) *Identification.* A pacemaker electrode function tester is a device which is connected to an implanted pacemaker lead that supplies an accurately calibrated, variable pacing pulse for measuring the patient's pacing threshold and intracardiac R-wave potential.

(b) *Classification.* Class II (performance standards).

### § 870.3730 Pacemaker service tools.

(a) *Identification.* Pacemaker service tools are devices such as screwdrivers and Allen wrenches, used to repair a pacemaker lead or to reconnect a pacemaker lead to a pacemaker generator.

(b) *Classification.* Class I (general controls). The device is exempt from the

## 21 CFR Ch. I (4–1–20 Edition)

premarket notification procedures in subpart E of part 807 of this chapter subject to the limitations in § 870.9.

[45 FR 7907, Feb. 5, 1980, as amended at 54 FR 25049, June 12, 1989; 66 FR 38797, July 25, 2001]

### § 870.3800 Annuloplasty ring.

(a) *Identification.* An annuloplasty ring is a rigid or flexible ring implanted around the mitral or tricuspid heart valve for reconstructive treatment of valvular insufficiency.

(b) *Classification.* Class II (special controls). The special control for this device is the FDA guidance document entitled "Guidance for Annuloplasty Rings 510(k) Submissions."

[45 FR 7907, Feb. 5, 1980, as amended at 52 FR 17736, May 11, 1987; 66 FR 18542, Apr. 10, 2001]

### § 870.3850 Carotid sinus nerve stimulator.

(a) *Identification.* A carotid sinus nerve stimulator is an implantable device used to decrease arterial pressure by stimulating Hering's nerve at the carotid sinus.

(b) *Classification.* Class III (premarket approval).

(c) *Date PMA or notice of completion of a PDP is required.* A PMA or a notice of completion of a PDP is required to be filed with the Food and Drug Administration on or before December 26, 1996 for any carotid sinus nerve stimulator that was in commercial distribution before May 28, 1976, or that has, on or before December 26, 1996 been found to be substantially equivalent to a carotid sinus nerve stimulator that was in commercial distribution before May 28, 1976. Any other carotid sinus nerve stimulator shall have an approved PMA or a declared completed PDP in effect before being placed in commercial distribution.

[45 FR 7907, Feb. 5, 1980, as amended at 52 FR 17736, May 11, 1987; 61 FR 50706, Sept. 27, 1996]

### § 870.3925 Replacement heart valve.

(a) *Identification.* A replacement heart valve is a device intended to perform the function of any of the heart's natural valves. This device includes valves constructed of prosthetic materials, biologic valves (e.g., porcine



valves), or valves constructed of a combination of prosthetic and biologic materials.

(b) *Classification*. Class III (premarket approval).

(c) *Date premarket approval application (PMA) or notice of completion of a product development protocol (PDP) is required*. A PMA or a notice of completion of a PDP is required to be filed with the Food and Drug Administration on or before December 9, 1987 for any replacement heart valve that was in commercial distribution before May 28, 1976, or that has on or before December 9, 1987 been found to be substantially equivalent to a replacement heart valve that was in commercial distribution before May 28, 1976. Any other replacement heart valve shall have an approved PMA or a declared completed PDP in effect before being placed in commercial distribution.

[45 FR 7907, Feb. 5, 1980, as amended at 52 FR 18163, May 13, 1987; 52 FR 23137, June 17, 1987]

**§ 870.3935 Prosthetic heart valve holder.**

(a) *Identification*. A prosthetic heart valve holder is a device used to hold a replacement heart valve while it is being sutured into place.

(b) *Classification*. Class I. The device is exempt from the premarket notification procedures in subpart E of part 807 of this chapter.

[45 FR 7907, Feb. 5, 1980, as amended at 61 FR 1121, Jan. 16, 1996]

**§ 870.3945 Prosthetic heart valve sizer.**

(a) *Identification*. A prosthetic heart valve sizer is a device used to measure the size of the natural valve opening to determine the size of the appropriate replacement heart valve.

(b) *Classification*. Class I (general controls). The device is exempt from the premarket notification procedures in subpart E of part 807 of this chapter subject to the limitations in § 870.9.

[45 FR 7907, Feb. 5, 1980, as amended at 61 FR 1121, Jan. 16, 1996; 66 FR 38797, July 25, 2001]

**Subpart E—Cardiovascular Surgical Devices**

**§ 870.4075 Endomyocardial biopsy device.**

(a) *Identification*. An endomyocardial biopsy device is a device used in a catheterization procedure to remove samples of tissue from the inner wall of the heart.

(b) *Classification*. Class II (performance standards).

**§ 870.4100 Extracorporeal circuit and accessories for long-term respiratory/cardiopulmonary failure.**

(a) *Identification*. An extracorporeal circuit and accessories for long-term respiratory/cardiopulmonary support (>6 hours) is a system of devices and accessories that provides assisted extracorporeal circulation and physiologic gas exchange of the patient's blood in patients with acute respiratory failure or acute cardiopulmonary failure, where other available treatment options have failed, and continued clinical deterioration is expected or the risk of death is imminent. The main devices and accessories of the system include, but are not limited to, the console (hardware), software, and disposables, including, but not limited to, an oxygenator, blood pump, heat exchanger, cannulae, tubing, filters, and other accessories (*e.g.*, monitors, detectors, sensors, connectors).

(b) *Classification*—Class II (special controls). The special controls for this device are:

(1) The technological characteristics of the device must ensure that the geometry and design parameters are consistent with the intended use, and that the devices and accessories in the circuit are compatible;

(2) The devices and accessories in the circuit must be demonstrated to be biocompatible;

(3) Sterility and shelf-life testing must demonstrate the sterility of any patient-contacting devices and accessories in the circuit and the shelf life of these devices and accessories;

(4) Non-clinical performance evaluation of the devices and accessories in the circuit must demonstrate substantial equivalence of the performance

## § 870.4200

characteristics on the bench, mechanical integrity, electromagnetic compatibility (where applicable), software, durability, and reliability;

(5) In vivo evaluation of the devices and accessories in the circuit must demonstrate their performance over the intended duration of use, including a detailed summary of the clinical evaluation pertinent to the use of the devices and accessories to demonstrate their effectiveness if a specific indication (patient population and/or condition) is identified; and

(6) Labeling must include a detailed summary of the non-clinical and in vivo evaluations pertinent to use of the devices and accessories in the circuit and adequate instructions with respect to anticoagulation, circuit setup, performance characteristics with respect to compatibility among different devices and accessories in the circuit, and maintenance during a procedure.

[81 FR 7451, Feb. 12, 2016]

### § 870.4200 **Cardiopulmonary bypass accessory equipment.**

(a) *Identification.* Cardiopulmonary bypass accessory equipment is a device that has no contact with blood and that is used in the cardiopulmonary bypass circuit to support, adjoin, or connect components, or to aid in the setup of the extracorporeal line, e.g., an oxygenator mounting bracket or system-priming equipment.

(b) *Classification.* (1) Class I. The device is classified as class I if it does not involve an electrical connection to the patient. The device is exempt from the premarket notification procedures in subpart E of part 807 of this chapter subject to § 870.9.

(2) Class II (special controls). The device is classified as class II if it involves an electrical connection to the patient. The special controls are as follows:

(i) The performance standard under part 898 of this chapter, and

(ii) The guidance document entitled "Guidance on the Performance Standard for Electrode Lead Wires and Patient Cables." The device is exempt from the premarket notification proce-

## 21 CFR Ch. I (4–1–20 Edition)

dures in subpart E of part 807 of this chapter subject to § 870.9.

[65 FR 19319, Apr. 11, 2000]

### § 870.4205 **Cardiopulmonary bypass bubble detector.**

(a) *Identification.* A cardiopulmonary bypass bubble detector is a device used to detect bubbles in the arterial return line of the cardiopulmonary bypass circuit.

(b) *Classification.* Class II (performance standards).

### § 870.4210 **Cardiopulmonary bypass vascular catheter, cannula, or tubing.**

(a) *Identification.* A cardiopulmonary bypass vascular catheter, cannula, or tubing is a device used in cardiopulmonary surgery to cannulate the vessels, perfuse the coronary arteries, and to interconnect the catheters and cannulas with an oxygenator. The device includes accessory bypass equipment.

(b) *Classification.* Class II (performance standards).

### § 870.4220 **Cardiopulmonary bypass heart-lung machine console.**

(a) *Identification.* A cardiopulmonary bypass heart-lung machine console is a device that consists of a control panel and the electrical power and control circuitry for a heart-lung machine. The console is designed to interface with the basic units used in a gas exchange system, including the pumps, oxygenator, and heat exchanger.

(b) *Classification.* Class II (performance standards).

### § 870.4230 **Cardiopulmonary bypass defoamer.**

(a) *Identification.* A cardiopulmonary bypass defoamer is a device used in conjunction with an oxygenator during cardiopulmonary bypass surgery to remove gas bubbles from the blood.

(b) *Classification.* Class II (special controls). The special control for this device is the FDA guidance document entitled "Guidance for Extracorporeal Blood Circuit Defoamer 510(k) Submissions."

[45 FR 7907, Feb. 5, 1980, as amended at 52 FR 17737, May 11, 1987; 66 FR 18542, Apr. 10, 2001]

**§ 870.4240 Cardiopulmonary bypass heat exchanger.**

(a) *Identification.* A cardiopulmonary bypass heat exchanger is a device, consisting of a heat exchange system used in extracorporeal circulation to warm or cool the blood or perfusion fluid flowing through the device.

(b) *Classification.* Class II (performance standards).

**§ 870.4250 Cardiopulmonary bypass temperature controller.**

(a) *Identification.* A cardiopulmonary bypass temperature controller is a device used to control the temperature of the fluid entering and leaving a heat exchanger.

(b) *Classification.* Class II (performance standards).

**§ 870.4260 Cardiopulmonary bypass arterial line blood filter.**

(a) *Identification.* A cardiopulmonary bypass arterial line blood filter is a device used as part of a gas exchange (oxygenator) system to filter nonbiologic particles and emboli (blood clots or pieces of foreign material flowing in the bloodstream which will obstruct circulation by blocking a vessel) out of the blood. It is used in the arterial return line.

(b) *Classification.* Class II (special controls). The special control for this device is the FDA guidance document entitled “Guidance for Cardiopulmonary Bypass Arterial Line Blood Filter 510(k) Submissions.”

[45 FR 7907, Feb. 5, 1980, as amended at 52 FR 17737, May 11, 1987; 66 FR 18542, Apr. 10, 2001]

**§ 870.4270 Cardiopulmonary bypass cardiomy suction line blood filter.**

(a) *Identification.* A cardiopulmonary bypass cardiomy suction line blood filter is a device used as part of a gas exchange (oxygenator) system to filter nonbiologic particles and emboli (a blood clot or a piece of foreign material flowing in the bloodstream which will obstruct circulation by blocking a vessel) out of the blood. This device is intended for use in the cardiomy suction line.

(b) *Classification.* Class II (performance standards).

**§ 870.4280 Cardiopulmonary prebypass filter.**

(a) *Identification.* A cardiopulmonary prebypass filter is a device used during priming of the oxygenator circuit to remove particulates or other debris from the circuit prior to initiating bypass. The device is not used to filter blood.

(b) *Classification.* Class II (special controls). The device is exempt from the premarket notification procedures in subpart E of part 807 of this chapter subject to the limitations in § 870.9.

[45 FR 7907, Feb. 5, 1980, as amended at 84 FR 71812, Dec. 30, 2019]

**§ 870.4290 Cardiopulmonary bypass adaptor, stopcock, manifold, or fitting.**

(a) *Identification.* A cardiopulmonary bypass adaptor, stopcock, manifold, or fitting is a device used in cardiovascular diagnostic, surgical, and therapeutic applications to interconnect tubing, catheters, or other devices.

(b) *Classification.* Class II (special controls). The device is exempt from the premarket notification procedures in subpart E of part 807 of this chapter subject to the limitations in § 870.9.

[45 FR 7907, Feb. 5, 1980, as amended at 84 FR 71812, Dec. 30, 2019]

**§ 870.4300 Cardiopulmonary bypass gas control unit.**

(a) *Identification.* A cardiopulmonary bypass gas control unit is a device used to control and measure the flow of gas into the oxygenator. The device is calibrated for a specific gas.

(b) *Classification.* Class II (performance standards).

**§ 870.4310 Cardiopulmonary bypass coronary pressure gauge.**

(a) *Identification.* A cardiopulmonary bypass coronary pressure gauge is a device used in cardiopulmonary bypass surgery to measure the pressure of the blood perfusing the coronary arteries.

(b) *Classification.* Class II (performance standards).

**§ 870.4320**

**21 CFR Ch. I (4–1–20 Edition)**

**§ 870.4320 Cardiopulmonary bypass pulsatile flow generator.**

(a) *Identification.* A cardiopulmonary bypass pulsatile flow generator is an electrically and pneumatically operated device used to create pulsatile blood flow. The device is placed in a cardiopulmonary bypass circuit downstream from the oxygenator.

(b) *Classification.* Class III (premarket approval).

(c) Date PMA or notice of completion of PDP is required. A PMA or notice of completion of a PDP is required to be filed with the Food and Drug Administration on or before September 21, 2004, for any cardiopulmonary bypass pulsatile flow generator that was in commercial distribution before May 28, 1976, or that has, on or before September 21, 2004, been found to be substantially equivalent to any cardiopulmonary bypass pulsatile flow generator that was in commercial distribution before May 28, 1976. Any other cardiopulmonary bypass pulsatile flow generator shall have an approved PMA or declared completed PDP in effect before being placed in commercial distribution.

[45 FR 7907, Feb. 5, 1980, as amended at 52 FR 17737, May 11, 1987; 69 FR 34920, June 23, 2004]

**§ 870.4330 Cardiopulmonary bypass on-line blood gas monitor.**

(a) *Identification.* A cardiopulmonary bypass on-line blood gas monitor is a device used in conjunction with a blood gas sensor to measure the level of gases in the blood.

(b) *Classification.* Class II (performance standards).

**§ 870.4340 Cardiopulmonary bypass level sensing monitor and/or control.**

(a) *Identification.* A cardiopulmonary bypass level sensing monitor and/or control is a device used to monitor and/or control the level of blood in the blood reservoir and to sound an alarm when the level falls below a predetermined value.

(b) *Classification.* Class II (special controls). The device is exempt from the premarket notification procedures

in subpart E of part 807 of this chapter subject to the limitations in § 870.9.

[45 FR 7907, Feb. 5, 1980, as amended at 84 FR 71812, Dec. 30, 2019]

**§ 870.4350 Cardiopulmonary bypass oxygenator.**

(a) *Identification.* A cardiopulmonary bypass oxygenator is a device used to exchange gases between blood and a gaseous environment to satisfy the gas exchange needs of a patient during open-heart surgery.

(b) *Classification.* Class II (special controls). The special control for this device is the FDA guidance document entitled “Guidance for Cardiopulmonary Bypass Oxygenators 510(k) Submissions.”

[45 FR 7907, Feb. 5, 1980, as amended at 52 FR 17737, May 11, 1987; 66 FR 18542, Apr. 10, 2001]

**§ 870.4360 Nonroller-type blood pump.**

(a) *Nonroller-type cardiopulmonary and circulatory bypass blood pump—(1) Identification.* A nonroller-type cardiopulmonary and circulatory bypass blood pump is a prescription device that uses a method other than revolving rollers to pump the blood through an extracorporeal circuit for periods lasting less than 6 hours for the purpose of providing either:

(i) Full or partial cardiopulmonary bypass (*i.e.*, circuit includes an oxygenator) during open surgical procedures on the heart or great vessels; or

(ii) Temporary circulatory bypass for diversion of flow around a planned disruption of the circulatory pathway necessary for open surgical procedures on the aorta or vena cava.

(2) *Classification—*Class II (special controls). The special controls for this device are:

(i) Non-clinical performance testing must perform as intended over the intended duration of use and demonstrate the following: Operating parameters, dynamic blood damage, heat generation, air entrapment, mechanical integrity, and durability/reliability;

(ii) The patient-contacting components of the device must be demonstrated to be biocompatible;

(iii) Sterility and shelf life testing must demonstrate the sterility of patient-contacting components and the shelf life of these components; and

(iv) Labeling must include information regarding the duration of use, and a detailed summary of the device- and procedure-related complications pertinent to use of the device.

(b) *Nonroller-type temporary ventricular support blood pump*—(1) *Identification*. A nonroller-type temporary ventricular support blood pump is a prescription device that uses any method resulting in blood propulsion to provide the temporary ventricular assistance required for support of the systemic and/or pulmonary circulations during periods when there is ongoing or anticipated hemodynamic instability due to immediately reversible alterations in ventricular myocardial function resulting from mechanical or physiologic causes. Duration of use would be less than 6 hours.

(2) *Classification*. Class III (premarket approval).

(c) *Date premarket approval application (PMA) or notice of completion of product development protocol (PDP) is required*. A PMA or notice of completion of a PDP is required to be filed with FDA on or before September 8, 2015, for any nonroller-type temporary ventricular support blood pump that was in commercial distribution before May 28, 1976, or that has, on or before September 8, 2015, been found to be substantially equivalent to any nonroller-type temporary ventricular support blood pump that was in commercial distribution before May 28, 1976. Any other nonroller-type temporary ventricular support blood pump shall have an approved PMA or declared completed PDP in effect before being placed in commercial distribution.

[80 FR 32311, June 8, 2015]

**§ 870.4370 Roller-type cardiopulmonary bypass blood pump.**

(a) *Identification*. A roller-type cardiopulmonary bypass blood pump is a device that uses a revolving roller mechanism to pump the blood through the cardiopulmonary bypass circuit during bypass surgery.

(b) *Classification*. Class II (performance standards).

**§ 870.4380 Cardiopulmonary bypass pump speed control.**

(a) *Identification*. A cardiopulmonary bypass pump speed control is a device used that incorporates an electrical system or a mechanical system, or both, and is used to control the speed of blood pumps used in cardiopulmonary bypass surgery.

(b) *Classification*. Class II (performance standards).

**§ 870.4390 Cardiopulmonary bypass pump tubing.**

(a) *Identification*. A cardiopulmonary bypass pump tubing is polymeric tubing which is used in the blood pump head and which is cyclically compressed by the pump to cause the blood to flow through the cardiopulmonary bypass circuit.

(b) *Classification*. Class II (performance standards).

**§ 870.4400 Cardiopulmonary bypass blood reservoir.**

(a) *Identification*. A cardiopulmonary bypass blood reservoir is a device used in conjunction with short-term extracorporeal circulation devices to hold a reserve supply of blood in the bypass circulation.

(b) *Classification*. Class II (special controls), except that a reservoir that contains a defoamer or filter is classified into the same class as the defoamer or filter. The device, when it is a cardiopulmonary bypass blood reservoir that does not contain defoamers or blood filters, is exempt from the premarket notification procedures in subpart E of part 807 of this chapter subject to the limitations in § 870.9.

[45 FR 7907, Feb. 5, 1980, as amended at 84 FR 71812, Dec. 30, 2019]

**§ 870.4410 Cardiopulmonary bypass in-line blood gas sensor.**

(a) *Identification*. A cardiopulmonary bypass in-line blood gas sensor is a transducer that measures the level of gases in the blood.

(b) *Classification*. Class II (performance standards).

**§ 870.4420**

**§ 870.4420 Cardiopulmonary bypass cardiotomy return sucker.**

(a) *Identification.* A cardiopulmonary bypass cardiotomy return sucker is a device that consists of tubing, a connector, and a probe or tip that is used to remove blood from the chest or heart during cardiopulmonary bypass surgery.

(b) *Classification.* Class II (special controls). The device is exempt from the premarket notification procedures in subpart E of part 807 of this chapter subject to the limitations in § 870.9.

[45 FR 7907, Feb. 5, 1980, as amended at 84 FR 71812, Dec. 30, 2019]

**§ 870.4430 Cardiopulmonary bypass intracardiac suction control.**

(a) *Identification.* A cardiopulmonary bypass intracardiac suction control is a device which provides the vacuum and control for a cardiotomy return sucker.

(b) *Classification.* Class II (special controls). The device is exempt from the premarket notification procedures in subpart E of part 807 of this chapter subject to the limitations in § 870.9.

[45 FR 7907, Feb. 5, 1980, as amended at 84 FR 71812, Dec. 30, 2019]

**§ 870.4450 Vascular clamp.**

(a) *Identification.* A vascular clamp is a surgical instrument used to occlude a blood vessel temporarily.

(b) *Classification.* Class II (performance standards).

**§ 870.4475 Surgical vessel dilator.**

(a) *Identification.* A surgical vessel dilator is a device used to enlarge or calibrate a vessel.

(b) *Classification.* Class II (performance standards).

**§ 870.4500 Cardiovascular surgical instruments.**

(a) *Identification.* Cardiovascular surgical instruments are surgical instruments that have special features for use in cardiovascular surgery. These devices include, e.g., forceps, retractors, and scissors.

(b) *Classification.* Class I (general controls). The device is exempt from the premarket notification procedures in

**21 CFR Ch. I (4–1–20 Edition)**

subpart E of part 807 of this chapter subject to the limitations in § 870.9.

[45 FR 7907, Feb. 5, 1980, as amended at 54 FR 25049, June 12, 1989; 66 FR 38797, July 25, 2001]

**§ 870.4510 Apical closure device.**

(a) *Identification.* An apical closure device is a prescription device consisting of a delivery system and implant component that is used for soft tissue approximation of cardiac apical tissue during transcatheter valve replacement procedures.

(b) *Classification.* Class II (special controls). The special controls for this device are:

(1) The patient contacting materials must be evaluated to be biocompatible.

(2) Performance data must validate the sterility of the patient-contacting components of the device.

(3) Performance data must support the shelf life of the device by demonstrating continued sterility, package integrity, and device functionality over the labeled shelf life.

(4) Non-clinical performance testing data must demonstrate that the device performs as intended under anticipated conditions of use. The following performance characteristics must be tested:

(i) Consistent and reliable implant deployment;

(ii) Assessment of implant pull-out force; and

(iii) Sheath size compatibility with implant.

(5) In vivo evaluation of the device must demonstrate device performance, including device operation resulting in closure of the myocardial wound.

(6) Labeling must include the following:

(i) Detailed information explaining how the device operates;

(ii) Sheath size that device can accommodate;

(iii) Identification of the minimum myocardial wall thickness to ensure optimal device function; and

(iv) A shelf life.

[81 FR 71371, Oct. 17, 2016]

**§ 870.4875 Intraluminal artery stripper.**

(a) *Identification.* An intraluminal artery stripper is a device used to perform an endarterectomy (removal of plaque deposits from arteriosclerotic arteries.)

(b) *Classification.* Class II (performance standards).

**§ 870.4885 External vein stripper.**

(a) *Identification.* An external vein stripper is an extravascular device used to remove a section of a vein.

(b) *Classification.* Class II (performance standards).

### Subpart F—Cardiovascular Therapeutic Devices

**§ 870.5050 Patient care suction apparatus.**

(a) *Identification.* A patient care suction apparatus is a device used with an intrathoracic catheter to withdraw fluid from the chest during the recovery period following surgery.

(b) *Classification.* Class II (performance standards).

**§ 870.5100 Percutaneous Transluminal Coronary Angioplasty (PTCA) Catheter.**

(a) *Standard PTCA Catheter—(1) Identification.* A PTCA catheter is a device that operates on the principle of hydraulic pressurization applied through an inflatable balloon attached to the distal end. A PTCA balloon catheter has a single or double lumen shaft. The catheter features a balloon of appropriate compliance for the clinical application, constructed from a polymer. The balloon is designed to uniformly expand to a specified diameter and length at a specific pressure as labeled, with well characterized rates of inflation and deflation and a defined burst pressure. The device generally features a type of radiographic marker to facilitate fluoroscopic visualization of the balloon during use. A PTCA catheter is intended for balloon dilatation of a hemodynamically significant coronary artery or bypass graft stenosis in patients evidencing coronary ischemia for the purpose of improving myocardial perfusion. A PTCA catheter may also be intended for the treatment of

acute myocardial infarction; treatment of in-stent restenosis (ISR) and/or post-deployment stent expansion.

(2) *Classification.* Class II (special controls). The special control for this device is “Class II Special Controls Guidance Document for Certain Percutaneous Transluminal Coronary Angioplasty (PTCA) Catheters.” See § 870.1(e) for the availability of this guidance document.

(b) *Cutting/scoring PTCA Catheter—(1) Identification.* A cutting/scoring PTCA catheter is a balloon-tipped catheter with cutting/scoring elements attached, which is used in those circumstances where a high pressure balloon resistant lesion is encountered. A cutting/scoring PTCA catheter is intended for the treatment of hemodynamically significant coronary artery stenosis for the purpose of improving myocardial perfusion. A cutting/scoring PTCA catheter may also be indicated for use in complex type C lesions or for the treatment of in-stent restenosis.

(2) *Classification.* Class III (premarket approval). As of May 28, 1976, an approval under section 515 of the act is required before this device may be commercially distributed. See § 870.3.

[75 FR 54496, Sept. 8, 2010]

**§ 870.5150 Embolectomy catheter.**

(a) *Identification.* An embolectomy catheter is a balloon-tipped catheter that is used to remove thromboemboli, i.e., blood clots which have migrated in blood vessels from one site in the vascular tree to another.

(b) *Classification.* Class II (performance standards).

**§ 870.5175 Septostomy catheter.**

(a) *Identification.* A septostomy catheter is a special balloon catheter that is used to create or enlarge the atrial septal defect found in the heart of certain infants.

(b) *Classification.* Class II (performance standards).

**§ 870.5200 External cardiac compressor.**

(a) *Identification.* An external cardiac compressor is an externally applied prescription device that is electrically, pneumatically, or manually powered

and is used to compress the chest periodically in the region of the heart to provide blood flow during cardiac arrest. External cardiac compressor devices are used as an adjunct to manual cardiopulmonary resuscitation (CPR) when effective manual CPR is not possible (*e.g.*, during patient transport or extended CPR when fatigue may prohibit the delivery of effective/consistent compressions to the victim, or when insufficient EMS personnel are available to provide effective CPR).

(b) *Classification*. Class II (special controls). The special controls for this device are:

(1) Nonclinical performance testing under simulated physiological conditions must demonstrate the reliability of the delivery of specific compression depth and rate over the intended duration of use.

(2) Labeling must include the following:

(i) The clinical training necessary for the safe use of this device;

(ii) Adjunctive use only indication prominently displayed on labels physically placed on the device and in any device manuals or other labeling;

(iii) Information on the patient population for which the device has been demonstrated to be effective (including patient size and/or age limitations, *e.g.*, adult, pediatric and/or infant); and

(iv) Information on the time necessary to deploy the device as demonstrated in the performance testing.

(3) For devices that incorporate electrical components, appropriate analysis and testing must demonstrate that the device is electrically safe and electromagnetically compatible in its intended use environment.

(4) Human factors testing and analysis must validate that the device design and labeling are sufficient for effective use by the intended user, including an evaluation for the time necessary to deploy the device.

(5) For devices containing software, software verification, validation, and hazard analysis must be performed.

(6) Components of the device that come into human contact must be demonstrated to be biocompatible.

[81 FR 33133, May 25, 2016]

### § 870.5210 Cardiopulmonary resuscitation (CPR) aid.

(a) *CPR aid without feedback*—(1) *Identification*. A CPR aid without feedback is a device that performs a simple function such as proper hand placement and/or simple prompting for rate and/or timing of compressions/breathing for the professionally trained rescuer, but offers no feedback related to the quality of the CPR being provided. These devices are intended for use by persons professionally trained in CPR to assure proper use and the delivery of optimal CPR to the victim.

(2) *Classification*. Class I (general controls). The device is exempt from the premarket notification procedures in subpart E of part 807 of this chapter subject to the limitations in § 870.9.

(b) *CPR aid with feedback*—(1) *Identification*. A CPR Aid device with feedback is a device that provides real-time feedback to the rescuer regarding the quality of CPR being delivered to the victim, and provides either audio and/or visual information to encourage the rescuer to continue the consistent application of effective manual CPR in accordance with current accepted CPR guidelines (to include, but not be limited to, parameters such as compression rate, compression depth, ventilation, recoil, instruction for one or multiple rescuers, etc.). These devices may also perform a coaching function to aid rescuers in the sequence of steps necessary to perform effective CPR on a victim.

(2) *Classification*. Class II (special controls). The special controls for this device are:

(i) Nonclinical performance testing under simulated physiological or use conditions must demonstrate the accuracy and reliability of the feedback to the user on specific compression rate, depth and/or respiration over the intended duration, and environment of use.

(ii) Labeling must include the clinical training, if needed, for the safe use of this device and information on the patient population for which the device has been demonstrated to be effective (including patient size and/or age limitations, *e.g.*, adult, pediatric and/or infant).



(iii) For devices that incorporate electrical components, appropriate analysis and testing must demonstrate that the device is electrically safe and electromagnetically compatible in its intended use environment.

(iv) For devices containing software, software verification, validation, and hazard analysis must be performed.

(v) Components of the device that come into human contact must be demonstrated to be biocompatible.

(vi) Human factors testing and analysis must validate that the device design and labeling are sufficient for effective use by the intended user.

(3) *Premarket notification.* The CPR Aid with feedback device is exempt from the premarket notification procedures in subpart E of part 807 of this chapter if it does not contain software (*e.g.*, is mechanical or electro-mechanical) and is in compliance with the special controls under paragraph (b)(2) of this section, subject to the limitations of exemptions in § 870.9.

[81 FR 33134, May 25, 2016]

**§ 870.5225 External counter-pulsating device.**

(a) *Identification.* An external counter-pulsating device is a noninvasive, prescription device used to assist the heart by applying positive or negative pressure to one or more of the body's limbs in synchrony with the heart cycle.

(b) *Classification.* (1) Class II (special controls) when the device is intended for the treatment of chronic stable angina that is refractory to optimal anti-anginal medical therapy and without options for revascularization. The special controls for this device are:

(i) Nonclinical performance evaluation of the device must demonstrate a reasonable assurance of safety and effectiveness for applied pressure, synchronization of therapy with the appropriate phase of the cardiac cycle, and functionality of alarms during a device malfunction or an abnormal patient condition;

(ii) Reliabilities of the mechanical and electrical systems must be established through bench testing under simulated use conditions and matched by appropriate maintenance schedules;

(iii) Software design and verification and validation must be appropriately documented;

(iv) The skin-contacting components of the device must be demonstrated to be biocompatible;

(v) Appropriate analysis and testing must be conducted to verify electrical safety and electromagnetic compatibility of the device; and

(vi) Labeling must include a detailed summary of the device-related and procedure-related complications pertinent to use of the device.

(2) Class III (premarket approval) for the following intended uses: Unstable angina pectoris; acute myocardial infarction; cardiogenic shock; congestive heart failure; postoperative treatment of patients who have undergone coronary artery bypass surgery; peripheral arterial disease associated with ischemic ulcers rest pain or claudication, threatened gangrene, insufficient blood supply at an amputation site, persisting ischemia after embolectomy or bypass surgery, and/or pre- and post-arterial reconstruction to improve runoff; diabetes complicated by peripheral arterial disease or other conditions possibly related to arterial insufficiency including nocturnal leg cramps and/or necrobiosis diabeticorum; venous diseases, including prophylaxis of deep vein thrombophlebitis, edema (*e.g.*, chronic lymphedema) and/or induration (*e.g.*, stasis dermatitis) associated with chronic venous stasis, venous stasis ulcers, and/or thrombophlebitis; athletic injuries, including Charley horses, pulled muscles and/or edematous muscles; necrotizing cellulitis.

(c) *Date premarket approval application (PMA) or notice of completion of product development protocol (PDP) is required.* A PMA or notice of completion of a PDP is required to be filed with FDA on or before March 31, 2014, for any external counter-pulsating device, with an intended use described in paragraph (b)(2) of this section, that was in commercial distribution before May 28, 1976, or that has, on or before March 31, 2014, been found to be substantially equivalent to any external counter-pulsating device, with an intended use described in paragraph (b)(2) of this section, that was in commercial distribution before May 28,

**§ 870.5300**

**21 CFR Ch. I (4–1–20 Edition)**

1976. Any other external counter-pulsating device with an intended use described in paragraph (b)(2) of this section shall have an approved PMA or declared completed PDP in effect before being placed in commercial distribution.

[78 FR 79307, Dec. 30, 2013]

**§ 870.5300 DC-defibrillator (including paddles).**

(a) *Low-energy DC-defibrillator—(1) Identification.* A low-energy DC-defibrillator is a device that delivers into a 50 ohm test load an electrical shock of a maximum of 360 joules of energy used for defibrillating (restoring normal heart rhythm) the atria or ventricles of the heart or to terminate other cardiac arrhythmias. This generic type of device includes low energy defibrillators with a maximum electrical output of less than 360 joules of energy that are used in pediatric defibrillation or in cardiac surgery. The device may either synchronize the shock with the proper phase of the electrocardiogram or may operate asynchronously. The device delivers the electrical shock through paddles placed either directly across the heart or on the surface of the body.

(2) *Classification.* Class II (performance standards).

(b) *High-energy DC-defibrillator—(1) Identification.* A high-energy DC-defibrillator is a device that delivers into a 50 ohm test load an electrical shock of greater than 360 joules of energy used for defibrillating the atria or ventricles of the heart or to terminate other cardiac arrhythmias. The device may either synchronize the shock with the proper phase of the electrocardiogram or may operate asynchronously. The device delivers the electrical shock through paddles placed either directly across the heart or on the surface of the body.

(2) *Classification.* Class III (premarket approval).

(c) *Date PMA or notice of completion of a PDP is required.* A PMA or a notice of completion of a PDP is required to be filed with the Food and Drug Administration on or before December 26, 1996 for any DC-defibrillator (including paddles) described in paragraph (b)(1) of this section that was in commercial

distribution before May 28, 1976, or that has, on or before December 26, 1996 been found to be substantially equivalent to a DC-defibrillator (including paddles) described in paragraph (b)(1) of this section that was in commercial distribution before May 28, 1976. Any other DC-defibrillator (including paddles) described in paragraph (b)(1) of this section shall have an approved PMA or declared completed PDP in effect before being placed in commercial distribution.

[45 FR 7907, Feb. 5, 1980, as amended at 52 FR 17737, May 11, 1987; 61 FR 50706, Sept. 27, 1996]

**§ 870.5310 Automated external defibrillator system.**

(a) *Identification.* An automated external defibrillator (AED) system consists of an AED and those accessories necessary for the AED to detect and interpret an electrocardiogram and deliver an electrical shock (e.g., battery, pad electrode, adapter, and hardware key for pediatric use). An AED system analyzes the patient's electrocardiogram, interprets the cardiac rhythm, and automatically delivers an electrical shock (fully automated AED), or advises the user to deliver the shock (semi-automated or shock advisory AED) to treat ventricular fibrillation or pulseless ventricular tachycardia.

(b) *Classification.* Class III (premarket approval)

(c) *Date PMA or notice of completion of PDP is required.* A PMA will be required to be submitted to the Food and Drug Administration by April 29, 2015, for any AED that was in commercial distribution before May 28, 1976, or that has, by April 29, 2015, been found to be substantially equivalent to any AED that was in commercial distribution before May 28, 1976. A PMA will be required to be submitted to the Food and Drug Administration by April 29, 2015, for any AED accessory described in paragraph (a) that was in commercial distribution before May 28, 1976, or that has, by April 29, 2015, been found to be substantially equivalent to any AED accessory described in paragraph (a) that was in commercial distribution before May 28, 1976. Any other AED and AED accessory described in paragraph (a), shall have an approved PMA or declared completed PDP in effect before

**Food and Drug Administration, HHS**

**§ 870.5700**

being placed in commercial distribution.

[68 FR 61344, Oct. 28, 2003; 69 FR 10615, Mar. 8, 2004, as amended at 80 FR 5682, Feb. 3, 2015]

**§ 870.5325 Defibrillator tester.**

(a) *Identification.* A defibrillator tester is a device that is connected to the output of a defibrillator and is used to measure the energy delivered by the defibrillator into a standard resistive load. Some testers also provide waveform information.

(b) *Classification.* Class II (performance standards).

**§ 870.5550 External transcutaneous cardiac pacemaker (noninvasive).**

(a) *Identification.* An external transcutaneous cardiac pacemaker (noninvasive) is a device used to supply a periodic electrical pulse intended to pace the heart. The pulse from the device is usually applied to the surface of the chest through electrodes such as defibrillator paddles.

(b) *Classification.* Class II. The special controls for this device are:

(1) "American National Standards Institute/American Association for Medical Instrumentation's DF-21 'Cardiac Defibrillator Devices' " 2d ed., 1996, and

(2) "The maximum pulse amplitude should not exceed 200 milliamperes. The maximum pulse duration should not exceed 50 milliseconds."

[45 FR 7907, Feb. 5, 1980, as amended at 52 FR 17737, May 11, 1987; 65 FR 17144, Mar. 31, 2000]

**§ 870.5700 Steerable cardiac ablation catheter remote control system.**

(a) *Identification.* A steerable cardiac ablation catheter remote control system is a prescription device that is external to the body and interacts with the manual handle of a steerable cardiac ablation catheter to remotely control the advancement, retraction, rotation, and deflection of a compatible, steerable ablation catheter used for the treatment of cardiac arrhythmias in the right side of the heart. The device allows reversion to manual control of the steerable cardiac ablation catheter without withdrawal of the catheter and interruption of the procedure.

(b) *Classification.* Class II (special controls). The special controls for this device are:

(1) Non-clinical mechanical performance testing must demonstrate that the device performs as intended under anticipated conditions of use. The following performance testing must be performed:

(i) Mechanical performance of the system (without catheter connected);

(ii) Mechanical performance of the system with compatible catheters connected to verify that the system does not impact catheter function or performance. Assessments must include the following:

(A) Side-by-side remote control and manual comparisons of catheter manipulation (including all ranges of motion of catheter deflection and tip curl) for all compatible catheters; must include testing for worst-case conditions, and

(B) Evaluation of the accuracy and function of all device control safety features; and

(iii) Simulated-use testing in a bench anatomic model or animal model.

(2) Non-clinical electrical testing must include validation of electromagnetic compatibility (EMC), electrical safety, thermal safety, and electrical system performance. The following performance testing must be performed:

(i) Electrical performance of the system with compatible catheters connected to verify that the system does not impact catheter function or performance. Assessments must include the following:

(A) Side-by-side remote control and manual comparisons of catheter manipulation (including all ranges of motion of catheter deflection and tip curl) for all compatible catheters; must include testing for worst-case conditions, and

(B) Evaluation of the accuracy and function of all device control safety features; and

(ii) Electrical safety between the device and ablation catheter system and with other electrical equipment expected in the catheter lab or operating room.

(3) In vivo testing must demonstrate that the device performs as intended

under anticipated conditions of use, including an assessment of the system impact on the functionality and performance of compatible catheters, and documentation of the adverse event profile associated with clinical use. Evidence must be submitted to address the following:

(i) **Manipulation and Positioning:** Ability to manipulate compatible catheters to pre-specified cardiac locations and confirm proper anatomic placement and tissue contact, in accordance with the system indications for use and the compatible catheter indications for use;

(ii) **Safety:** Assess device-related complication rate and major procedural complication rate (regardless of device relatedness) in comparison to literature and/or a manual comparison group for compatible ablation catheters to support the indications for use;

(iii) **Efficacy:** Assess ablation success in comparison to literature and/or a manual comparison group for compatible ablation catheters to support the indications for use; and

(iv) User assessment of device remote controls and safety features.

(4) Post-market surveillance (PMS) must be conducted and completed in accordance with FDA agreed upon PMS protocol.

(5) A training program must be included with sufficient educational elements that, upon completion of the training program, the clinician and supporting staff can:

(i) Identify the safe environments for device use,

(ii) Use all safety features of device, and

(iii) Operate the device in simulated or actual use environments representative of indicated environments and use for the indication of compatible catheters.

(6) Performance data must demonstrate the sterility of the sterile disposable components of the system.

(7) Performance data must support shelf life by demonstrating continued sterility of the device (of the sterile disposable components), package integrity, and device functionality over the requested shelf life.

(8) Labeling must include the following:

(i) Appropriate instructions, warnings, cautions, limitations, and information related to the intended patient population, compatible ablation catheters, and the device safeguards for the safe use of the device;

(ii) Specific instructions and the clinical training needed for the safe use of the device, which includes:

(A) Instructions on assembling the device in all available configurations, including installation and removal of compatible catheters;

(B) Instructions and explanation of all controls, inputs, and outputs;

(C) Instructions on all available modes or states of the device;

(D) Instructions on all safety features of the device; and

(E) Validated methods and instructions for reprocessing/disinfecting any reusable components;

(iii) A detailed summary of the mechanical compatibility testing including:

(A) A table with a complete list of compatible catheters tested (manufacturer trade name and model number), and

(B) A table with detailed test results, including type of test, acceptance criteria, and test results (*i.e.*, pass for meeting acceptance criteria);

(iv) A detailed summary of the in vivo testing including:

(A) A table with a complete list of compatible catheters used during testing (manufacturer trade name and model number);

(B) Adverse events encountered pertinent to use of the device under use conditions;

(C) A detailed summary of the device- and procedure-related complications; and

(D) A summary of study outcomes and endpoints. Information pertinent to the fluoroscopy times/exposure for the procedure, patient, and operator fluoroscopic exposure;

(v) Other labeling items:

(A) A detailed summary of pertinent non-clinical testing information: EMC, mechanical, electrical, and sterilization of device and components;

(B) A detailed summary of the device technical parameters; and

(C) An expiration date/shelf life and storage conditions for the sterile accessories; and

(vi) When available, and according to the timeframe included in the PMS protocol agreed upon with FDA, provide a detailed summary of the PMS data including:

(A) Updates to the labeling to accurately reflect outcomes or necessary modifications based upon data collected during the PMS experience, and

(B) Inclusion of results and adverse events associated with utilization of the device during the PMS.

[80 FR 58606, Sept. 30, 2015]

**§ 870.5800 Compressible limb sleeve.**

(a) *Identification.* A compressible limb sleeve is a device that is used to prevent pooling of blood in a limb by inflating periodically a sleeve around the limb.

(b) *Classification.* Class II (performance standards).

**§ 870.5900 Thermal regulating system.**

(a) *Identification.* A thermal regulating system is an external system consisting of a device that is placed in contact with the patient and a temperature controller for the device. The system is used to regulate patient temperature.

(b) *Classification.* Class II (performance standards).

**§ 870.5910 Esophageal thermal regulation device.**

(a) *Identification.* An esophageal thermal regulation device is a prescription device used to apply a specified temperature to the endoluminal surface of the esophagus via an external controller. This device may incorporate a mechanism for gastric decompression and suctioning. The device is used to regulate patient temperature.

(b) *Classification.* Class II (special controls). The special controls for this device are:

(1) The patient contacting materials must be demonstrated to be biocompatible.

(2) Non-clinical performance evaluation must demonstrate that the device performs as intended under anticipated conditions of use. The following per-

formance characteristics must be tested:

(i) Mechanical integrity testing.

(ii) Testing to determine temperature change rate(s).

(iii) Testing to demonstrate compatibility with the indicated external controller.

(iv) Shelf life testing.

(3) Animal testing must demonstrate that the device does not cause esophageal injury and that body temperature remains within appropriate boundaries under anticipated conditions of use.

(4) Labeling must include the following:

(i) Detailed insertion instructions.

(ii) Warning against attaching the device to unintended connections, such as external controllers for which the device is not indicated, or pressurized air outlets instead of vacuum outlets for those devices, including gastric suction.

(iii) The operating parameters, name, and model number of the indicated external controller.

(iv) The intended duration of use.

[80 FR 49896, Aug. 18, 2015]

**§ 870.5925 Automatic rotating tourniquet.**

(a) *Identification.* An automatic rotating tourniquet is a device that prevents blood flow in one limb at a time, which temporarily reduces the total blood volume, thereby reducing the normal workload of the heart.

(b) *Classification.* Class II (performance standards).

**PART 872—DENTAL DEVICES**

**Subpart A—General Provisions**

Sec.

872.1 Scope.

872.3 Effective dates of requirement for pre-market approval.

872.9 Limitations of exemptions from section 510(k) of the Federal Food, Drug, and Cosmetic Act (the act).

**Subpart B—Diagnostic Devices**

872.1500 Gingival fluid measurer.

872.1720 Pulp tester.

872.1730 Electrode gel for pulp testers.

872.1740 Caries detection device.

872.1745 Laser fluorescence caries detection device.

**Pt. 872****21 CFR Ch. I (4-1-20 Edition)**

872.1800 Extraoral source x-ray system.  
 872.1810 Intraoral source x-ray system.  
 872.1820 Dental x-ray exposure alignment device.  
 872.1830 Cephalometer.  
 872.1840 Dental x-ray position indicating device.  
 872.1850 Lead-lined position indicator.  
 872.1870 Sulfide detection device.  
 872.1905 Dental x-ray film holder.  
 872.2050 Dental sonography device.  
 872.2060 Jaw tracking device.

**Subpart C [Reserved]****Subpart D—Prosthetic Devices**

872.3060 Noble metal alloy.  
 872.3070 Dental amalgam, mercury, and amalgam alloy.  
 872.3080 Mercury and alloy dispenser.  
 872.3100 Dental amalgamator.  
 872.3110 Dental amalgam capsule.  
 872.3130 Preformed anchor.  
 872.3140 Resin applicator.  
 872.3150 Articulator.  
 872.3165 Precision attachment.  
 872.3200 Resin tooth bonding agent.  
 872.3220 Facebow.  
 872.3240 Dental bur.  
 872.3250 Calcium hydroxide cavity liner.  
 872.3260 Cavity varnish.  
 872.3275 Dental cement.  
 872.3285 Preformed clasp.  
 872.3300 Hydrophilic resin coating for dentures.  
 872.3310 Coating material for resin fillings.  
 872.3330 Preformed crown.  
 872.3350 Gold or stainless steel cusp.  
 872.3360 Preformed cusp.  
 872.3400 Karaya and sodium borate with or without acacia denture adhesive.  
 872.3410 Ethylene oxide homopolymer and/or carboxymethylcellulose sodium denture adhesive.  
 872.3420 Carboxymethylcellulose sodium and cationic polyacrylamide polymer denture adhesive.  
 872.3450 Ethylene oxide homopolymer and/or karaya denture adhesive.  
 872.3480 Polyacrylamide polymer (modified cationic) denture adhesive.  
 872.3490 Carboxymethylcellulose sodium and/or polyvinylmethylether maleic acid calcium-sodium double salt denture adhesive.  
 872.3500 Polyvinylmethylether maleic anhydride (PVM-MA), acid copolymer, and carboxymethylcellulose sodium (NACMC) denture adhesive.  
 872.3520 OTC denture cleanser.  
 872.3530 Mechanical denture cleaner.  
 872.3540 OTC denture cushion or pad.  
 872.3560 OTC denture reliner.  
 872.3570 OTC denture repair kit.  
 872.3580 Preformed gold denture tooth.  
 872.3590 Preformed plastic denture tooth.

872.3600 Partially fabricated denture kit.  
 872.3630 Endosseous dental implant abutment.  
 872.3640 Endosseous dental implant.  
 872.3645 Subperiosteal implant material.  
 872.3660 Impression material.  
 872.3661 Optical Impression Systems for CAD/CAM.  
 872.3670 Resin impression tray material.  
 872.3680 Polytetrafluoroethylene (PTFE) vitreous carbon materials.  
 872.3690 Tooth shade resin material.  
 872.3710 Base metal alloy.  
 872.3730 Pantograph.  
 872.3740 Retentive and splinting pin.  
 872.3750 Bracket adhesive resin and tooth conditioner.  
 872.3760 Denture relining, repairing, or re-basing resin.  
 872.3765 Pit and fissure sealant and conditioner.  
 872.3770 Temporary crown and bridge resin.  
 872.3810 Root canal post.  
 872.3820 Root canal filling resin.  
 872.3830 Endodontic paper point.  
 872.3840 Endodontic silver point.  
 872.3850 Gutta percha.  
 872.3890 Endodontic stabilizing splint.  
 872.3900 Posterior artificial tooth with a metal insert.  
 872.3910 Backing and facing for an artificial tooth.  
 872.3920 Porcelain tooth.  
 872.3930 Bone grafting material.  
 872.3940 Total temporomandibular joint prosthesis.  
 872.3950 Glenoid fossa prosthesis.  
 872.3960 Mandibular condyle prosthesis.  
 872.3970 Interarticular disc prosthesis (interpositional implant).  
 872.3980 Endosseous dental implant accessories.

**Subpart E—Surgical Devices**

872.4120 Bone cutting instrument and accessories.  
 872.4130 Intraoral dental drill.  
 872.4200 Dental handpiece and accessories.  
 872.4465 Gas-powered jet injector.  
 872.4475 Spring-powered jet injector.  
 872.4535 Dental diamond instrument.  
 872.4565 Dental hand instrument.  
 872.4600 Intraoral ligature and wire lock.  
 872.4620 Fiber optic dental light.  
 872.4630 Dental operating light.  
 872.4730 Dental injecting needle.  
 872.4760 Bone plate.  
 872.4770 Temporary mandibular condyle reconstruction plate.  
 872.4840 Rotary scaler.  
 872.4850 Ultrasonic scaler.  
 872.4880 Intraosseous fixation screw or wire.  
 872.4920 Dental electrosurgical unit and accessories.

**Subpart F—Therapeutic Devices**

- 872.5410 Orthodontic appliance and accessories.
- 872.5470 Orthodontic plastic bracket.
- 872.5500 Extraoral orthodontic headgear.
- 872.5525 Preformed tooth positioner.
- 872.5550 Teething ring.
- 872.5560 Electrical salivary stimulatory system.
- 872.5570 Intraoral devices for snoring and intraoral devices for snoring and obstructive sleep apnea.
- 872.5571 Auto titration device for oral appliances.
- 872.5580 Oral rinse to reduce the adhesion of dental plaque.

**Subpart G—Miscellaneous Devices**

- 872.6010 Abrasive device and accessories.
- 872.6030 Oral cavity abrasive polishing agent.
- 872.6050 Saliva absorber.
- 872.6070 Ultraviolet activator for polymerization.
- 872.6080 Airbrush.
- 872.6100 Anesthetic warmer.
- 872.6140 Articulation paper.
- 872.6200 Base plate shellac.
- 872.6250 Dental chair and accessories.
- 872.6290 Prophylaxis cup.
- 872.6300 Rubber dam and accessories.
- 872.6350 Ultraviolet detector.
- 872.6390 Dental floss.
- 872.6475 Heat source for bleaching teeth.
- 872.6510 Oral irrigation unit.
- 872.6570 Impression tube.
- 872.6640 Dental operative unit and accessories.
- 872.6650 Massaging pick or tip for oral hygiene.
- 872.6660 Porcelain powder for clinical use.
- 872.6670 Silicate protector.
- 872.6710 Boiling water sterilizer.
- 872.6730 Endodontic dry heat sterilizer.
- 872.6770 Cartridge syringe.
- 872.6855 Manual toothbrush.
- 872.6865 Powered toothbrush.
- 872.6870 Disposable fluoride tray.
- 872.6880 Preformed impression tray.
- 872.6890 Intraoral dental wax.

AUTHORITY: 21 U.S.C. 351, 360, 360c, 360e, 360j, 360l, 371.

SOURCE: 52 FR 30097, Aug. 12, 1987, unless otherwise noted.

EDITORIAL NOTE: Nomenclature changes to part 872 appear at 73 FR 35341, June 23, 2008.

**Subpart A—General Provisions****§ 872.1 Scope.**

(a) This part sets forth the classification of dental devices intended for

human use that are in commercial distribution.

(b) The identification of a device in a regulation in this part is not a precise description of every device that is, or will be, subject to the regulation. A manufacturer who submits a premarket notification submission for a device under part 807 cannot show merely that the device is accurately described by the section title and identification provisions of a regulation in this part, but shall state why the device is substantially equivalent to other devices, as required by § 807.87.

(c) To avoid duplicative listings, a dental device that has two or more types of uses (e.g., used both as a diagnostic device and as a therapeutic device) is listed in one subpart only.

(d) References in this part to regulatory sections of the Code of Federal Regulations are to chapter I of title 21 unless otherwise noted.

(e) Guidance documents referenced in this part are available on the Internet at <http://www.fda.gov/MedicalDevices/DeviceRegulationandGuidance/GuidanceDocuments/default.htm>.

[52 FR 30097, Aug. 12, 1987, as amended at 68 FR 19737, Apr. 22, 2003; 79 FR 50552, Aug. 25, 2014]

**§ 872.3 Effective dates of requirement for premarket approval.**

A device included in this part that is classified into class III (premarket approval) shall not be commercially distributed after the date shown in the regulation classifying the device unless the manufacturer has an approval under section 515 of the act (unless an exemption has been granted under section 520(g)(2) of the act). An approval under section 515 of the act consists of FDA's issuance of an order approving an application for premarket approval (PMA) for the device or declaring completed a product development protocol (PDP) for the device.

(a) Before FDA requires that a device commercially distributed before the enactment date of the amendments, or a device that has been found substantially equivalent to such a device, has an approval under section 515 of the

act, FDA must promulgate a regulation under section 515(b) of the act requiring such approval, except as provided in paragraphs (b) and (c) of this section. Such a regulation under section 515(b) of the act shall not be effective during the grace period ending on the 90th day after its promulgation or on the last day of the 30th full calendar month after the regulation that classifies the device into class III is effective, whichever is later. See section 501(f)(2)(B) of the act. Accordingly, unless an effective date of the requirement for premarket approval is shown in the regulation for a device classified into class III in this part, the device may be commercially distributed without FDA's issuance of an order approving a PMA or declaring completed a PDP for the device. If FDA promulgates a regulation under section 515(b) of the act requiring premarket approval for a device, section 501(f)(1)(A) of the act applies to the device.

(b) Any new, not substantially equivalent, device introduced into commercial distribution on or after May 28, 1976, including a device formerly marketed that has been substantially altered, is classified by statute (section 513(f) of the act) into class III without any grace period and FDA must have issued an order approving a PMA or declaring completed a PDP for the device before the device is commercially distributed unless it is reclassified. If FDA knows that a device being commercially distributed may be a "new" device as defined in this section because of any new intended use or other reasons, FDA may codify the statutory classification of the device into class III for such new use. Accordingly, the regulation for such a class III device states that as of the enactment date of the amendments, May 28, 1976, the device must have an approval under section 515 of the act before commercial distribution.

(c) A device identified in a regulation in this part that is classified into class III and that is subject to the transitional provisions of section 520(1) of the act is automatically classified by statute into class III and must have an approval under section 515 of the act before being commercially distributed. Accordingly, the regulation for such a

class III transitional device states that as of the enactment date of the amendments, May 28, 1976, the device must have an approval under section 515 of the act before commercial distribution.

**§ 872.9 Limitations of exemptions from section 510(k) of the Federal Food, Drug, and Cosmetic Act (the act).**

The exemption from the requirement of premarket notification (section 510(k) of the act) for a generic type of class I or II device is only to the extent that the device has existing or reasonably foreseeable characteristics of commercially distributed devices within that generic type or, in the case of in vitro diagnostic devices, only to the extent that misdiagnosis as a result of using the device would not be associated with high morbidity or mortality. Accordingly, manufacturers of any commercially distributed class I or II device for which FDA has granted an exemption from the requirement of premarket notification must still submit a premarket notification to FDA before introducing or delivering for introduction into interstate commerce for commercial distribution the device when:

(a) The device is intended for a use different from the intended use of a legally marketed device in that generic type of device; e.g., the device is intended for a different medical purpose, or the device is intended for lay use where the former intended use was by health care professionals only;

(b) The modified device operates using a different fundamental scientific technology than a legally marketed device in that generic type of device; e.g., a surgical instrument cuts tissue with a laser beam rather than with a sharpened metal blade, or an in vitro diagnostic device detects or identifies infectious agents by using deoxyribonucleic acid (DNA) probe or nucleic acid hybridization technology rather than culture or immunoassay technology; or

(c) The device is an in vitro device that is intended:

(1) For use in the diagnosis, monitoring, or screening of neoplastic diseases with the exception of immunohistochemical devices;



(2) For use in screening or diagnosis of familial or acquired genetic disorders, including inborn errors of metabolism;

(3) For measuring an analyte that serves as a surrogate marker for screening, diagnosis, or monitoring life-threatening diseases such as acquired immune deficiency syndrome (AIDS), chronic or active hepatitis, tuberculosis, or myocardial infarction or to monitor therapy;

(4) For assessing the risk of cardiovascular diseases;

(5) For use in diabetes management;

(6) For identifying or inferring the identity of a microorganism directly from clinical material;

(7) For detection of antibodies to microorganisms other than immunoglobulin G (IgG) or IgG assays when the results are not qualitative, or are used to determine immunity, or the assay is intended for use in matrices other than serum or plasma;

(8) For noninvasive testing as defined in § 812.3(k) of this chapter; and

(9) For near patient testing (point of care).

[65 FR 2314, Jan. 14, 2000]

### Subpart B—Diagnostic Devices

#### § 872.1500 Gingival fluid measurer.

(a) *Identification.* A gingival fluid measurer is a gauge device intended to measure the amount of fluid in the gingival sulcus (depression between the tooth and gums) to determine if there is a gingivitis condition.

(b) *Classification.* Class I (general controls). The device is exempt from the premarket notification procedures in subpart E of part 807 of this chapter subject to the limitations in § 872.9.

[52 FR 30097, Aug. 12, 1987, as amended at 59 FR 63007, Dec. 7, 1994; 66 FR 38797, July 25, 2001]

#### § 872.1720 Pulp tester.

(a) *Identification.* A pulp tester is an AC or battery powered device intended to evaluate the pulpal vitality of teeth by employing high frequency current transmitted by an electrode to stimulate the nerve tissue in the dental pulp.

(b) *Classification.* Class II (special controls). The device is exempt from

the premarket notification procedures in subpart E of part 807 of this chapter subject to the limitations in § 872.9.

[52 FR 30097, Aug. 12, 1987, as amended at 84 FR 71812, Dec. 30, 2019]

#### § 872.1730 Electrode gel for pulp testers.

(a) *Identification.* An electrode gel for pulp testers is a device intended to be applied to the surface of a tooth before use of a pulp tester to aid conduction of electrical current.

(b) *Classification.* Class I (general controls). The device is exempt from the premarket notification procedures in subpart E of part 807 of this chapter subject to the limitations in § 872.9.

[52 FR 30097, Aug. 12, 1987, as amended at 54 FR 13830, Apr. 5, 1989; 66 FR 38797, July 25, 2001]

#### § 872.1740 Caries detection device.

(a) *Identification.* The caries detection device is a device intended to show the existence of decay in a patient's tooth by use of electrical current.

(b) *Classification.* Class II.

#### § 872.1745 Laser fluorescence caries detection device.

(a) *Identification.* A laser fluorescence caries detection device is a laser, a fluorescence detector housed in a dental handpiece, and a control console that performs device calibration, as well as variable tone emitting and fluorescence measurement functions. The intended use of the device is to aid in the detection of tooth decay by measuring increased laser induced fluorescence.

(b) *Classification.* Class II, subject to the following special controls:

(1) Sale, distribution, and use of this device are restricted to prescription use in accordance with § 801.109 of this chapter;

(2) Premarket notifications must include clinical studies, or other relevant information, that demonstrates that the device aids in the detection of tooth decay by measuring increased laser induced fluorescence; and

(3) The labeling must include detailed use instructions with precautions that urge users to:

(i) Read and understand all directions before using the device,

## § 872.1800

- (ii) Store probe tips under proper conditions,
- (iii) Properly sterilize the emitter-detector handpick before each use, and
- (iv) Properly maintain and handle the instrument in the specified manner and condition.

[65 FR 18235, Apr. 7, 2000]

### § 872.1800 Extraoral source x-ray system.

(a) *Identification.* An extraoral source x-ray system is an AC-powered device that produces x-rays and is intended for dental radiographic examination and diagnosis of diseases of the teeth, jaw, and oral structures. The x-ray source (a tube) is located outside the mouth. This generic type of device may include patient and equipment supports and component parts.

(b) *Classification.* Class II.

### § 872.1810 Intraoral source x-ray system.

(a) *Identification.* An intraoral source x-ray system is an electrically powered device that produces x-rays and is intended for dental radiographic examination and diagnosis of diseases of the teeth, jaw, and oral structures. The x-ray source (a tube) is located inside the mouth. This generic type of device may include patient and equipment supports and component parts.

(b) *Classification.* Class II.

### § 872.1820 Dental x-ray exposure alignment device.

(a) *Identification.* A dental x-ray exposure alignment device is a device intended to position x-ray film and to align the examination site with the x-ray beam.

(b) *Classification.* Class I (general controls). The device is exempt from the premarket notification procedures in subpart E of part 807 of this chapter subject to the limitations in § 872.9.

[52 FR 30097, Aug. 12, 1987, as amended at 59 FR 63008, Dec. 7, 1994; 66 FR 38797, July 25, 2001]

### § 872.1830 Cephalometer.

(a) *Identification.* A cephalometer is a device used in dentistry during x-ray procedures. The device is intended to

## 21 CFR Ch. I (4–1–20 Edition)

place and to hold a patient's head in a standard position during dental x-rays.

(b) *Classification.* Class II.

### § 872.1840 Dental x-ray position indicating device.

(a) *Identification.* A dental x-ray position indicating device is a device, such as a collimator, cone, or aperture, that is used in dental radiographic examination. The device is intended to align the examination site with the x-ray beam and to restrict the dimensions of the dental x-ray field by limiting the size of the primary x-ray beam.

(b) *Classification.* Class I (general controls). The device is exempt from the premarket notification procedures in subpart E of part 807 of this chapter subject to the limitations in § 872.9.

[52 FR 30097, Aug. 12, 1987, as amended at 61 FR 1121, Jan. 16, 1996; 66 FR 38797, July 25, 2001]

### § 872.1850 Lead-lined position indicator.

(a) *Identification.* A lead-lined position indicator is a cone-shaped device lined with lead that is attached to a dental x-ray tube and intended to aid in positioning the tube, to prevent the misfocusing of the x-rays by absorbing divergent radiation, and to prevent leakage of radiation.

(b) *Classification.* Class I (general controls). The device is exempt from the premarket notification procedures in subpart E of part 807 of this chapter subject to the limitations in § 872.9.

[52 FR 30097, Aug. 12, 1987, as amended at 61 FR 1121, Jan. 16, 1996; 66 FR 38797, July 25, 2001]

### § 872.1870 Sulfide detection device.

(a) *Identification.* A sulfide detection device is a device consisting of an AC-powered control unit, probe handle, probe tips, cables, and accessories. This device is intended to be used in vivo, to manually measure periodontal pocket probing depths, detect the presence or absence of bleeding on probing, and detect the presence of sulfides in periodontal pockets, as an adjunct in the diagnosis of periodontal diseases in adult patients.

(b) *Classification.* Class II (special controls) prescription use in accordance with § 801.109 of this chapter; conformance with recognized standards of biocompatibility, electrical safety, and sterility; clinical and analytical performance testing, and proper labeling.

[63 FR 59717, Nov. 5, 1998]

**§ 872.1905 Dental x-ray film holder.**

(a) *Identification.* A dental x-ray film holder is a device intended to position and to hold x-ray film inside the mouth.

(b) *Classification.* Class I (general controls). The device is exempt from the premarket notification procedures in subpart E of part 807 of this chapter subject to the limitations in § 872.9. If the device is not labeled or otherwise represented as sterile, it is also exempt from the current good manufacturing practice requirements of the quality system regulation in part 820 of this chapter, with the exceptions of § 820.180, with respect to general requirements concerning records, and § 820.198, with respect to complaint files.

[52 FR 30097, Aug. 12, 1987, as amended at 54 FR 13830, Apr. 5, 1989; 66 FR 38797, July 25, 2001]

**§ 872.2050 Dental sonography device.**

(a) *Dental sonography device for monitoring—(1) Identification.* A dental sonography device for monitoring is an electrically powered device, intended to be used to monitor temporomandibular joint sounds. The device detects and records sounds made by the temporomandibular joint.

(2) *Classification.* Class I. The device is exempt from the premarket notification provisions of subpart E of part 807 of this chapter subject to § 872.9.

(b) *Dental sonography device for interpretation and diagnosis—(1) Identification.* A dental sonography device for interpretation and diagnosis is an electrically powered device, intended to interpret temporomandibular joint sounds for the diagnosis of temporomandibular joint disorders and associated orofacial pain. The device detects, records, displays, and stores sounds made by the temporomandibular joint during jaw

movement. The device interprets these sounds to generate meaningful output, either directly or by connection to a personal computer. The device may be part of a system of devices, contributing joint sound information to be considered with data from other diagnostic components.

(2) *Classification.* Class II (special controls). The special control for this device is FDA's guidance document entitled "Class II Special Controls Guidance Document: Dental Sonography and Jaw Tracking Devices."

[68 FR 67367, Dec. 2, 2003]

**§ 872.2060 Jaw tracking device.**

(a) *Jaw tracking device for monitoring mandibular jaw positions relative to the maxilla—(1) Identification.* A jaw tracking device for monitoring mandibular jaw positions relative to the maxilla is a nonpowered or electrically powered device that measures and records anatomical distances and angles in three dimensional space, to determine the relative position of the mandible with respect to the location and position of the maxilla, while at rest and during jaw movement.

(2) *Classification.* Class I (general controls). The device is exempt from the premarket notification provisions of subpart E of part 807 of this chapter subject to § 872.9.

(b) *Jaw tracking device for interpretation of mandibular jaw positions for the diagnosis—(1) Identification.* A jaw tracking device for interpretation of mandibular jaw positions relative to the maxilla for the diagnosis of temporomandibular joint disorders and associated orofacial pain is a nonpowered or electrically powered device that measures and records anatomical distances and angles to determine the relative position of the mandible in three dimensional space, with respect to the location and position of the maxilla, while at rest and during jaw movement. The device records, displays, and stores information about jaw position. The device interprets jaw position to generate meaningful output, either directly or by connection to a personal computer. The device may be a part of a system of devices, contributing jaw position information to

## § 872.3060

be considered with data from other diagnostic components.

(2) *Classification.* Class II (special controls). The special control for this device is FDA's guidance document entitled "Class II Special Controls Guidance Document: Dental Sonography and Jaw Tracking Devices."

[68 FR 67367, Dec. 2, 2003]

### Subpart C [Reserved]

### Subpart D—Prosthetic Devices

#### § 872.3060 Noble metal alloy.

(a) *Identification.* A noble metal alloy is a device composed primarily of noble metals, such as gold, palladium, platinum, or silver, that is intended for use in the fabrication of cast or porcelain-fused-to-metal crown and bridge restorations.

(b) *Classification.* Class II (special controls). The special control for these devices is FDA's "Class II Special Controls Guidance Document: Dental Noble Metal Alloys." The devices are exempt from the premarket notification procedures in subpart E of part 807 of this chapter subject to the limitations in § 872.9. See § 872.1(e) for availability of guidance information.

[69 FR 51766, Aug. 23, 2004]

#### § 872.3070 Dental amalgam, mercury, and amalgam alloy.

(a) *Identification.* Dental amalgam is a device that consists of a combination of elemental mercury, supplied as a liquid in bulk, sachet, or predosed capsule form, and amalgam alloy composed primarily of silver, tin, and copper, supplied as a powder in bulk, tablet, or predosed capsule form, for the direct filling of carious lesions or structural defects in teeth. This device also includes the individual component devices, mercury and amalgam alloy, when intended to be combined with each other to form dental amalgam.

(b) *Classification.* Class II (special controls). The special control for this device is FDA's "Class II Special Controls Guidance Document: Dental Amalgam, Mercury, and Amalgam

## 21 CFR Ch. I (4–1–20 Edition)

Alloy." See § 872.1(e) for the availability of this guidance document.

[74 FR 38714, Aug. 4, 2009]

#### § 872.3080 Mercury and alloy dispenser.

(a) *Identification.* A mercury and alloy dispenser is a device with a spring-activated valve intended to measure and dispense into a mixing capsule a predetermined amount of dental mercury in droplet form and a premeasured amount of alloy pellets.

(b) *Classification.* Class I (general controls). The device is exempt from the premarket notification procedures in subpart E of part 807 of this chapter subject to the limitations in § 872.9.

[52 FR 30097, Aug. 12, 1987, as amended at 54 FR 13830, Apr. 5, 1989; 66 FR 38797, July 25, 2001]

#### § 872.3100 Dental amalgamator.

(a) *Identification.* A dental amalgamator is a device, usually AC-powered, intended to mix, by shaking, amalgam capsules containing mercury and dental alloy particles, such as silver, tin, zinc, and copper. The mixed dental amalgam material is intended for filling dental caries.

(b) *Classification.* Class I (general controls). The device is exempt from the premarket notification procedures in subpart E of part 807 of this chapter subject to the limitations in § 872.9.

[55 FR 48439, Nov. 20, 1990, as amended at 59 FR 63008, Dec. 7, 1994; 66 FR 38797, July 25, 2001]

#### § 872.3110 Dental amalgam capsule.

(a) *Identification.* A dental amalgam capsule is a container device in which silver alloy is intended to be mixed with mercury to form dental amalgam.

(b) *Classification.* Class I (general controls). The device is exempt from the premarket notification procedures in subpart E of part 807 of this chapter subject to the limitations in § 872.9.

[52 FR 30097, Aug. 12, 1987, as amended at 54 FR 13830, Apr. 5, 1989; 66 FR 38797, July 25, 2001]

#### § 872.3130 Preformed anchor.

(a) *Identification.* A preformed anchor is a device made of austenitic alloys or alloys containing 75 percent or greater

gold or metals of the platinum group intended to be incorporated into a dental appliance, such as a denture, to help stabilize the appliance in the patient's mouth.

(b) *Classification*. Class I (general controls). The device is exempt from the premarket notification procedures in subpart E of part 807 of this chapter subject to the limitations in § 872.9.

[52 FR 30097, Aug. 12, 1987, as amended at 59 FR 63008, Dec. 7, 1994; 66 FR 38797, July 25, 2001]

#### § 872.3140 Resin applicator.

(a) *Identification*. A resin applicator is a brushlike device intended for use in spreading dental resin on a tooth during application of tooth shade material.

(b) *Classification*. Class I (general controls). The device is exempt from the premarket notification procedures in subpart E of part 807 of this chapter subject to the limitations in § 872.9. If the device is not labeled or otherwise represented as sterile, the device is exempt from the current good manufacturing practice requirements of the quality system regulation in part 820 of this chapter, with the exceptions of § 820.180, with respect to general requirements concerning records, and § 820.198, with respect to complaint files.

[52 FR 30097, Aug. 12, 1987, as amended at 54 FR 13830, Apr. 5, 1989; 66 FR 38797, July 25, 2001]

#### § 872.3150 Articulator.

(a) *Identification*. An articulator is a mechanical device intended to simulate movements of a patient's upper and lower jaws. Plaster casts of the patient's teeth and gums are placed in the device to reproduce the occlusion (bite) and articulation of the patient's jaws. An articulator is intended to fit dentures or provide orthodontic treatment.

(b) *Classification*. Class I (general controls). The device is exempt from the premarket notification procedures in subpart E of part 807 of this chapter subject to the limitations in § 872.9. If the device is not labeled or otherwise represented as sterile, the device is exempt from the current good manufacturing practice requirements of the

quality system regulation in part 820 of this chapter, with the exceptions of § 820.180, with respect to general requirements concerning records, and § 820.198, with respect to complaint files.

[52 FR 30097, Aug. 12, 1987, as amended at 54 FR 13830, Apr. 5, 1989; 66 FR 38797, July 25, 2001]

#### § 872.3165 Precision attachment.

(a) *Identification*. A precision attachment or preformed bar is a device made of austenitic alloys or alloys containing 75 percent or greater gold and metals of the platinum group intended for use in prosthetic dentistry in conjunction with removable partial dentures. Various forms of the device are intended to connect a lower partial denture with another lower partial denture, to connect an upper partial denture with another upper partial denture, to connect either an upper or lower partial denture to a tooth or a crown, or to connect a fixed bridge to a partial denture.

(b) *Classification*. Class I (general controls). The device is exempt from the premarket notification procedures in subpart E of part 807 of this chapter subject to the limitations in § 872.9.

[52 FR 30097, Aug. 12, 1987, as amended at 59 FR 63008, Dec. 7, 1994; 66 FR 38797, July 25, 2001]

#### § 872.3200 Resin tooth bonding agent.

(a) *Identification*. A resin tooth bonding agent is a device material, such as methylmethacrylate, intended to be painted on the interior of a prepared cavity of a tooth to improve retention of a restoration, such as a filling.

(b) *Classification*. Class II.

#### § 872.3220 Facebow.

(a) *Identification*. A facebow is a device intended for use in denture fabrication to determine the spatial relationship between the upper and lower jaws. This determination is intended for use in placing denture casts accurately into an articulator (§ 872.3150) and thereby aiding correct placement of artificial teeth into a denture base.

(b) *Classification*. Class I (general controls). The device is exempt from the premarket notification procedures in

## § 872.3240

subpart E of part 807 of this chapter subject to the limitations in § 872.9. If the device is not labeled or otherwise represented as sterile, the device is exempt from the current good manufacturing practice requirements of the quality system regulation in part 820 of this chapter, with the exceptions of § 820.180, with respect to general requirements concerning records, and § 820.198, with respect to complaint files.

[52 FR 30097, Aug. 12, 1987, as amended at 54 FR 13830, Apr. 5, 1989; 66 FR 38797, July 25, 2001]

### § 872.3240 Dental bur.

(a) *Identification.* A dental bur is a rotary cutting device made from carbon steel or tungsten carbide intended to cut hard structures in the mouth, such as teeth or bone. It is also intended to cut hard metals, plastics, porcelains, and similar materials intended for use in the fabrication of dental devices.

(b) *Classification.* Class I (general controls). The device is exempt from the premarket notification procedures in subpart E of part 807 of this chapter subject to the limitations in § 872.9.

[52 FR 30097, Aug. 12, 1987, as amended at 59 FR 63008, Dec. 7, 1994; 66 FR 38798, July 25, 2001]

### § 872.3250 Calcium hydroxide cavity liner.

(a) *Identification.* A calcium hydroxide cavity liner is a device material intended to be applied to the interior of a prepared cavity before insertion of restorative material, such as amalgam, to protect the pulp of a tooth.

(b) *Classification.* Class II.

### § 872.3260 Cavity varnish.

(a) *Identification.* Cavity varnish is a device that consists of a compound intended to coat a prepared cavity of a tooth before insertion of restorative materials. The device is intended to prevent penetration of restorative materials, such as amalgam, into the dentinal tissue.

(b) *Classification.* Class II (special controls). The device, when it is an external cleaning solution, is exempt from the premarket notification procedures in subpart E of part 807 of this

## 21 CFR Ch. I (4–1–20 Edition)

chapter subject to the limitations in § 872.9.

[52 FR 30097, Aug. 12, 1987, as amended at 84 FR 71812, Dec. 30, 2019]

### § 872.3275 Dental cement.

(a) *Zinc oxide-eugenol—(1) Identification.* Zinc oxide-eugenol is a device composed of zinc oxide-eugenol intended to serve as a temporary tooth filling or as a base cement to affix a temporary tooth filling, to affix dental devices such as crowns or bridges, or to be applied to a tooth to protect the tooth pulp.

(2) *Classification.* Class I (general controls). The device is exempt from the premarket notification procedures in subpart E of part 807 of this chapter subject to § 872.9.

(b) *Dental cement other than zinc oxide-eugenol—(1) Identification.* Dental cement other than zinc oxide-eugenol is a device composed of various materials other than zinc oxide-eugenol intended to serve as a temporary tooth filling or as a base cement to affix a temporary tooth filling, to affix dental devices such as crowns or bridges, or to be applied to a tooth to protect the tooth pulp.

(2) *Classification.* Class II.

[52 FR 30097, Aug. 12, 1987, as amended at 65 FR 2314, Jan. 14, 2000]

### § 872.3285 Preformed clasp.

(a) *Identification.* A preformed clasp or a preformed wire clasp is a prefabricated device made of austenitic alloys or alloys containing 75 percent or greater gold and metals of the platinum group intended to be incorporated into a dental appliance, such as a partial denture, to help stabilize the appliance in the patient's mouth by fastening the appliance to an adjacent tooth.

(b) *Classification.* Class I (general controls). The device is exempt from the premarket notification procedures in subpart E of part 807 of this chapter subject to the limitations in § 872.9.

[52 FR 30097, Aug. 12, 1987, as amended at 59 FR 63008, Dec. 7, 1994; 66 FR 38798, July 25, 2001]

**§ 872.3300 Hydrophilic resin coating for dentures.**

(a) *Identification.* A hydrophilic resin coating for dentures is a device that consists of a water-retaining polymer that is intended to be applied to the base of a denture before the denture is inserted into the patient's mouth to improve denture retention and comfort.

(b) *Classification.* Class II (special controls). The device is exempt from the premarket notification procedures in subpart E of part 807 of this chapter subject to the limitations in § 872.9.

[52 FR 30097, Aug. 12, 1987, as amended at 84 FR 71812, Dec. 30, 2019]

**§ 872.3310 Coating material for resin fillings.**

(a) *Identification.* A coating material for resin fillings is a device intended to be applied to the surface of a restorative resin dental filling to attain a smooth, glaze-like finish on the surface of the filling.

(b) *Classification.* Class II.

**§ 872.3330 Preformed crown.**

(a) *Identification.* A preformed crown is a prefabricated device made of plastic or austenitic alloys or alloys containing 75 percent or greater gold and metals of the platinum group intended to be affixed temporarily to a tooth after removal of, or breakage of, the natural crown (that portion of the tooth that normally protrudes above the gums). It is intended for use as a functional restoration until a permanent crown is constructed. The device also may be intended for use as a functional restoration for a badly decayed deciduous (baby) tooth until the adult tooth erupts.

(b) *Classification.* Class I (general controls). The device is exempt from the premarket notification procedures in subpart E of part 807 of this chapter subject to the limitations in § 872.9.

[52 FR 30097, Aug. 12, 1987, as amended at 59 FR 63008, Dec. 7, 1994; 66 FR 38798, July 25, 2001]

**§ 872.3350 Gold or stainless steel cusp.**

(a) *Identification.* A gold or stainless steel cusp is a prefabricated device made of austenitic alloys or alloys con-

taining 75 percent or greater gold and metals of the platinum group or stainless steel intended to provide a permanent cusp (a projection on the chewing surface of a tooth) to achieve occlusal harmony (a proper bite) between the teeth and a removable denture.

(b) *Classification.* Class I (general controls). The device is exempt from the premarket notification procedures in subpart E of part 807 of this chapter subject to the limitations in § 872.9.

[52 FR 30097, Aug. 12, 1987, as amended at 59 FR 63008, Dec. 7, 1994; 66 FR 38798, July 25, 2001]

**§ 872.3360 Preformed cusp.**

(a) *Identification.* A performed cusp is a prefabricated device made of plastic or austenitic alloys or alloys containing 75 percent or greater gold and metals of the platinum group intended to be used as a temporary cusp (a projection on the chewing surface of a tooth) to achieve occlusal harmony (a proper bite) before permanent restoration of a tooth.

(b) *Classification.* Class I (general controls). The device is exempt from the premarket notification procedures in subpart E of part 807 of this chapter subject to the limitations in § 872.9.

[52 FR 30097, Aug. 12, 1987, as amended at 59 FR 63008, Dec. 7, 1994; 66 FR 38798, July 25, 2001]

**§ 872.3400 Karaya and sodium borate with or without acacia denture adhesive.**

(a) *Identification.* A karaya and sodium borate with or without acacia denture adhesive is a device composed of karaya and sodium borate with or without acacia intended to be applied to the base of a denture before the denture is inserted into patient's mouth to improve denture retention and comfort.

(b) *Classification.* (1) Class I (general controls) if the device contains less than 12 percent by weight of sodium borate. The class I device is exempt from the premarket notification procedures in subpart E of part 807 of this chapter subject to § 872.9.

(2) Class III if the device contains 12 percent or more by weight of sodium borate.

**§ 872.3410**

(c) *Date PMA or notice of completion of a PDP is required.* A PMA or a notice of completion of a PDP is required to be filed with the Food and Drug Administration on or before December 26, 1996 for any karaya and sodium borate with or without acacia denture adhesive that was in commercial distribution before May 28, 1976, or that has, on or before December 26, 1996 been found to be substantially equivalent to a karaya and sodium borate with or without acacia denture adhesive that was in commercial distribution before May 28, 1976. Any other karaya and sodium borate with or without acacia denture adhesive shall have an approved PMA or a declared completed PDP in effect before being placed in commercial distribution.

[52 FR 30097, Aug. 12, 1987, as amended at 61 FR 50706, Sept. 27, 1996; 65 FR 2315, Jan. 14, 2000]

**§ 872.3410 Ethylene oxide homopolymer and/or carboxymethylcellulose sodium denture adhesive.**

(a) *Identification.* An ethylene oxide homopolymer and/or carboxymethylcellulose sodium denture adhesive is a device containing ethylene oxide homopolymer and/or carboxymethylcellulose sodium intended to be applied to the base of a denture before the denture is inserted in a patient's mouth to improve denture retention and comfort.

(b) *Classification.* Class I (general controls). The device is exempt from the premarket notification procedures in subpart E of part 807 of this chapter subject to the limitations in § 872.9.

[52 FR 30097, Aug. 12, 1987, as amended at 59 FR 63008, Dec. 7, 1994; 66 FR 38798, July 25, 2001]

**§ 872.3420 Carboxymethylcellulose sodium and cationic polyacrylamide polymer denture adhesive.**

(a) *Identification.* A carboxymethylcellulose sodium and cationic polyacrylamide polymer denture adhesive is a device composed of carboxymethylcellulose sodium and cationic polyacrylamide polymer intended to be applied to the base of a denture before the denture is inserted

**21 CFR Ch. I (4-1-20 Edition)**

in a patient's mouth to improve denture retention and comfort.

(b) *Classification.* Class III.

(c) *Date PMA or notice of completion of a PDP is required.* A PMA or a notice of completion of a PDP is required to be filed with the Food and Drug Administration on or before December 26, 1996 for any carboxymethylcellulose sodium and cationic polyacrylamide polymer denture adhesive that was in commercial distribution before May 28, 1976, or that has, on or before December 26, 1996 been found to be substantially equivalent to a carboxymethylcellulose sodium and cationic polyacrylamide polymer denture adhesive that was in commercial distribution before May 28, 1976. Any other carboxymethylcellulose sodium and cationic polyacrylamide polymer denture adhesive shall have an approved PMA or a declared completed PDP in effect before being placed in commercial distribution.

[52 FR 30097, Aug. 12, 1987, as amended at 61 FR 50707, Sept. 27, 1996]

**§ 872.3450 Ethylene oxide homopolymer and/or karaya denture adhesive.**

(a) *Identification.* Ethylene oxide homopolymer and/or karaya denture adhesive is a device composed of ethylene oxide homopolymer and/or karaya intended to be applied to the base of a denture before the denture is inserted in a patient's mouth to improve denture retention and comfort.

(b) *Classification.* (1) Class I if the device is made of wax-impregnated cotton cloth that the patient applies to the base or inner surface of a denture before inserting the denture into the mouth. The device is intended to be discarded following 1 day's use. The class I device is exempt from the premarket notification procedures in subpart E of part 807 of this chapter subject to § 872.9.

[52 FR 30097, Aug. 12, 1987, as amended at 59 FR 63008, Dec. 7, 1994; 65 FR 2315, Jan. 14, 2000]

**§ 872.3480 Polyacrylamide polymer (modified cationic) denture adhesive.**

(a) *Identification.* A polyacrylamide polymer (modified cationic) denture adhesive is a device composed of



polyacrylamide polymer (modified cationic) intended to be applied to the base of a denture before the denture is inserted in a patient's mouth to improve denture retention and comfort.

(b) *Classification.* Class III.

(c) *Date PMA or notice of completion of a PDP is required.* A PMA or a notice of completion of a PDP is required to be filed with the Food and Drug Administration on or before December 26, 1996 for any polyacrylamide polymer (modified cationic) denture adhesive that was in commercial distribution before May 28, 1976, or that has, on or before December 26, 1996 been found to be substantially equivalent to a polyacrylamide polymer (modified cationic) denture adhesive that was in commercial distribution before May 28, 1976. Any other polyacrylamide polymer (modified cationic) denture adhesive shall have an approved PMA or a declared completed PDP in effect before being placed in commercial distribution.

[52 FR 30097, Aug. 12, 1987, as amended at 61 FR 50707, Sept. 27, 1996]

**§ 872.3490 Carboxymethylcellulose sodium and/or polyvinylmethylether maleic acid calcium-sodium double salt denture adhesive.**

(a) *Identification.* A carboxymethylcellulose sodium and/or polyvinylmethylether maleic acid calcium-sodium double salt denture adhesive is a device composed of carboxymethylcellulose sodium and/or polyvinylmethylether maleic acid calcium-sodium double salt intended to be applied to the base of a denture before the denture is inserted in a patient's mouth to improve denture retention and comfort.

(b) *Classification.* Class I (general controls). The device is exempt from the premarket notification procedures in subpart E of part 807 of this chapter subject to the limitations in § 872.9.

[52 FR 30097, Aug. 12, 1987, as amended at 59 FR 63008, Dec. 7, 1994; 66 FR 38798, July 25, 2001]

**§ 872.3500 Polyvinylmethylether maleic anhydride (PVM-MA), acid copolymer, and carboxymethylcellulose sodium (NACMC) denture adhesive.**

(a) *Identification.* Polyvinylmethylether maleic anhydride (PVM-MA), acid copolymer, and carboxymethylcellulose sodium (NACMC) denture adhesive is a device composed of polyvinylmethylether maleic anhydride, acid copolymer, and carboxymethylcellulose sodium intended to be applied to the base of a denture before the denture is inserted in a patient's mouth to improve denture retention and comfort.

(b) *Classification.* Class III.

(c) *Date PMA or notice of completion of a PDP is required.* A PMA or a notice of completion of a PDP is required to be filed with the Food and Drug Administration on or before December 26, 1996 for any polyvinylmethylether maleic anhydride (PVM-MA), acid copolymer, and carboxymethylcellulose sodium (NACMC) denture adhesive that was in commercial distribution before May 28, 1976, or that has, on or before December 26, 1996 been found to be substantially equivalent to a polyvinylmethylether maleic anhydride (PVM-MA), acid copolymer, and carboxymethylcellulose sodium (NACMC) denture adhesive that was in commercial distribution before May 28, 1976. Any other polyvinylmethylether maleic anhydride (PVM-MA), acid copolymer, and carboxymethylcellulose sodium (NACMC) denture adhesive shall have an approved PMA or a declared completed PDP in effect before being placed in commercial distribution.

[52 FR 30097, Aug. 12, 1987, as amended at 61 FR 50707, Sept. 27, 1996]

**§ 872.3520 OTC denture cleanser.**

(a) *Identification.* An OTC denture cleanser is a device that consists of material in the form of a powder, tablet, or paste that is intended to remove debris from removable prosthetic dental appliances, such as bridges or dentures. The dental appliance is removed from the patient's mouth when the appliance is cleaned.

(b) *Classification.* Class I (general controls). The device is exempt from the

## § 872.3530

premarket notification procedures in subpart E of part 807 of this chapter subject to the limitations in § 872.9.

[52 FR 30097, Aug. 12, 1987, as amended at 59 FR 63008, Dec. 7, 1994; 66 FR 38798, July 25, 2001]

### § 872.3530 Mechanical denture cleaner.

(a) *Identification.* A mechanical denture cleaner is a device, usually AC-powered, that consists of a container for mechanically agitating a denture cleansing solution. The device is intended to clean a denture by submersion in the agitating cleansing solution in the container.

(b) *Classification.* Class I (general controls). The device is exempt from the premarket notification procedures in subpart E of part 807 of this chapter subject to the limitations in § 872.9.

[55 FR 48439, Nov. 20, 1990, as amended at 59 FR 63008, Dec. 7, 1994; 66 FR 38798, July 25, 2001]

### § 872.3540 OTC denture cushion or pad.

(a) *Identification.* An OTC denture cushion or pad is a prefabricated or noncustom made disposable device that is intended to improve the fit of a loose or uncomfortable denture, and may be available for purchase over-the-counter.

(b) *Classification.* (1) Class I if the device is made of wax-impregnated cotton cloth that the patient applies to the base or inner surface of a denture before inserting the denture into the mouth. The device is intended to be discarded following 1 day's use. The class I device is exempt from the premarket notification procedures in subpart E of part 807 of this chapter subject to § 872.9.

(2) Class II (special controls) if the OTC denture cushion or pad is made of a material other than wax-impregnated cotton cloth or if the intended use of the device differs from that described in paragraph (b)(1) of this section. The device is exempt from the premarket notification procedures in subpart E of part 807 of this chapter subject to the limitations in § 872.9. The special controls for this device are FDA's:

(i) "Use of International Standard ISO 10993 'Biological Evaluation of

## 21 CFR Ch. I (4-1-20 Edition)

Medical—Devices Part I: Evaluation and Testing,'" and

(ii) "OTC Denture Reliners, Repair Kits, and Partially Fabricated Denture Kits.'" ]

[52 FR 30097, Aug. 12, 1987, as amended at 65 FR 2315, 2000; 65 FR 17144, Mar. 31, 2000; 84 FR 71812, Dec. 30, 2019]

### § 872.3560 OTC denture reliner.

(a) *Identification.* An OTC denture reliner is a device consisting of a material such as plastic resin that is intended to be applied as a permanent coating or lining on the base or tissue-contacting surface of a denture. The device is intended to replace a worn denture lining and may be available for purchase over the counter.

(b) *Classification.* Class II (special controls). The device is exempt from the premarket notification procedures in subpart E of part 807 of this chapter subject to the limitations in § 872.9. The special controls for this device are FDA's:

(1) "Use of International Standard ISO 10993 'Biological Evaluation of Medical Devices—Part I: Evaluation and Testing,'" and

(2) "OTC Denture Reliners, Repair Kits, and Partially Fabricated Denture Kits.'" ]

[52 FR 30097, Aug. 12, 1987, as amended at 61 FR 50707, Sept. 27, 1996; 65 FR 17144, Mar. 31, 2000; 84 FR 71812, Dec. 30, 2019]

### § 872.3570 OTC denture repair kit.

(a) *Identification.* An OTC denture repair kit is a device consisting of a material, such as a resin monomer system of powder and liquid glues, that is intended to be applied permanently to a denture to mend cracks or breaks. The device may be available for purchase over-the-counter.

(b) *Classification.* Class II. The OTC denture repair kit is exempt from premarket notification procedures in subpart E of part 807 of this chapter, subject to § 872.9. The special controls for this device are FDA's:

(1) "Use of International Standard ISO 10993 'Biological Evaluation of Medical Devices—Part I: Evaluation and Testing,'" and

**Food and Drug Administration, HHS**

**§ 872.3640**

(2) “OTC Denture Reliners, Repair Kits, and Partially Fabricated Denture Kits.”

[52 FR 30097, Aug. 12, 1987, as amended at 65 FR 17144, Mar. 31, 2000; 83 FR 11145, Mar. 14, 2018]

**§ 872.3580 Preformed gold denture tooth.**

(a) *Identification.* A preformed gold denture tooth is a device composed of austenitic alloys or alloys containing 75 percent or greater gold and metals of the platinum group intended for use as a tooth or a portion of a tooth in a fixed or removable partial denture.

(b) *Classification.* Class I (general controls). The device is exempt from the premarket notification procedures in subpart E of part 807 of this chapter subject to the limitations in § 872.9.

[52 FR 30097, Aug. 12, 1987, as amended at 59 FR 63008, Dec. 7, 1994; 66 FR 38798, July 25, 2001]

**§ 872.3590 Preformed plastic denture tooth.**

(a) *Identification.* A preformed plastic denture tooth is a prefabricated device, composed of materials such as methyl methacrylate, that is intended for use as a tooth in a denture.

(b) *Classification.* Class II (special controls). The device is exempt from the premarket notification procedures in subpart E of part 807 of this chapter subject to the limitations in § 872.9.

[52 FR 30097, Aug. 12, 1987, as amended at 84 FR 71812, Dec. 30, 2019]

**§ 872.3600 Partially fabricated denture kit.**

(a) *Identification.* A partially fabricated denture kit is a device composed of connected preformed teeth that is intended for use in construction of a denture. A denture base is constructed using the patient’s mouth as a mold, by partially polymerizing the resin denture base materials while the materials are in contact with the oral tissues. After the denture base is constructed, the connected preformed teeth are chemically bonded to the base.

(b) *Classification.* Class II (special controls). The device is exempt from the premarket notification procedures

in subpart E of part 807 of this chapter subject to the limitations in § 872.9. The special controls for this device are FDA’s:

(1) “Use of International Standard ISO 10993 ‘Biological Evaluation of Medical Devices—Part I: Evaluation and Testing,’” and

(2) “OTC Denture Reliners, Repair Kits, and Partially Fabricated Denture Kits.”

[52 FR 30097, Aug. 12, 1987, as amended at 65 FR 17144, Mar. 31, 2000; 84 FR 71812, Dec. 30, 2019]

**§ 872.3630 Endosseous dental implant abutment.**

(a) *Identification.* An endosseous dental implant abutment is a premanufactured prosthetic component directly connected to the endosseous dental implant and is intended for use as an aid in prosthetic rehabilitation.

(b) *Classification.* Class II (special controls). The guidance document entitled “Class II Special Controls Guidance Document: Root-Form Endosseous Dental Implants and Endosseous Dental Implant Abutments” will serve as the special control. (See § 872.1(e) for the availability of this guidance document.)

[69 FR 26304, May 12, 2004]

**§ 872.3640 Endosseous dental implant.**

(a) *Identification.* An endosseous dental implant is a prescription device made of a material such as titanium or titanium alloy that is intended to be surgically placed in the bone of the upper or lower jaw arches to provide support for prosthetic devices, such as artificial teeth, in order to restore a patient’s chewing function.

(b) *Classification.* (1) Class II (special controls). The device is classified as class II if it is a root-form endosseous dental implant. The root-form endosseous dental implant is characterized by four geometrically distinct types: Basket, screw, solid cylinder, and hollow cylinder. The guidance document entitled “Class II Special Controls Guidance Document: Root-Form Endosseous Dental Implants and

## § 872.3645

Endosseous Dental Implant Abutments” will serve as the special control. (See §872.1(e) for the availability of this guidance document.)

(2) *Classification.* Class II (special controls). The device is classified as class II if it is a blade-form endosseous dental implant. The special controls for this device are:

(i) The design characteristics of the device must ensure that the geometry and material composition are consistent with the intended use;

(ii) Mechanical performance (fatigue) testing under simulated physiological conditions to demonstrate maximum load (endurance limit) when the device is subjected to compressive and shear loads;

(iii) Corrosion testing under simulated physiological conditions to demonstrate corrosion potential of each metal or alloy, couple potential for an assembled dissimilar metal implant system, and corrosion rate for an assembled dissimilar metal implant system;

(iv) The device must be demonstrated to be biocompatible;

(v) Sterility testing must demonstrate the sterility of the device;

(vi) Performance testing to evaluate the compatibility of the device in a magnetic resonance (MR) environment;

(vii) Labeling must include a clear description of the technological features, how the device should be used in patients, detailed surgical protocol and restoration procedures, relevant precautions and warnings based on the clinical use of the device, and qualifications and training requirements for device users including technicians and clinicians;

(viii) Patient labeling must contain a description of how the device works, how the device is placed, how the patient needs to care for the implant, possible adverse events and how to report any complications; and

(ix) Documented clinical experience must demonstrate safe and effective use and capture any adverse events observed during clinical use.

[69 FR 26304, May 12, 2004, as amended at 79 FR 34625, June 18, 2014]

## 21 CFR Ch. I (4–1–20 Edition)

### § 872.3645 Subperiosteal implant material.

(a) *Identification.* Subperiosteal implant material is a device composed of titanium or cobalt chrome molybdenum intended to construct custom prosthetic devices which are surgically implanted into the lower or upper jaw between the periosteum (connective tissue covering the bone) and supporting bony structures. The device is intended to provide support for prostheses, such as dentures.

(b) *Classification.* Class II.

### § 872.3660 Impression material.

(a) *Identification.* Impression material is a device composed of materials such as alginate or polysulfide intended to be placed on a preformed impression tray and used to reproduce the structure of a patient’s teeth and gums. The device is intended to provide models for study and for production of restorative prosthetic devices, such as gold inlays and dentures.

(b) *Classification.* Class II (Special Controls).

[52 FR 30097, Aug. 12, 1987, as amended at 68 FR 19738, Apr. 22, 2003]

### § 872.3661 Optical Impression Systems for CAD/CAM.

(a) *Identification.* An optical impression system for computer assisted design and manufacturing (CAD/CAM) is a device used to record the topographical characteristics of teeth, dental impressions, or stone models by analog or digital methods for use in the computer-assisted design and manufacturing of dental restorative prosthetic devices. Such systems may consist of a camera, scanner, or equivalent type of sensor and a computer with software.

(b) *Classification.* Class II (Special Controls). The device is exempt from the premarket notification procedures in subpart E of part 807 of the chapter subject to the limitations in §872.9. The special control for these devices is the FDA guidance document entitled “Class II Special Controls Guidance Document: Optical Impression Systems for Computer Assisted Design and Manufacturing (CAD/CAM) of Dental Restorations; Guidance for Industry and

**Food and Drug Administration, HHS**

**§ 872.3730**

FDA.” For the availability of this guidance document, see §872.1(e).

[68 FR 19738, Apr. 22, 2003]

**§ 872.3670 Resin impression tray material.**

(a) *Identification.* Resin impression tray material is a device intended for use in a two-step dental mold fabricating process. The device consists of a resin material, such as methyl methacrylate, and is used to form a custom impression tray for use in cases in which a preformed impression tray is not suitable, such as the fabrication of crowns, bridges, or full dentures. A preliminary plaster or stone model of the patient’s teeth and gums is made. The resin impression tray material is applied to this preliminary study model to form a custom tray. This tray is then filled with impression material and inserted into the patient’s mouth to make an impression, from which a final, more precise, model of the patient’s mouth is cast.

(b) *Classification.* Class I (general controls). The device is exempt from the premarket notification procedures in subpart E of part 807 of this chapter subject to the limitations in §872.9. If the device is not labeled or otherwise represented as sterile, it is exempt from the current good manufacturing practice requirements of the quality system regulation in part 820 of this chapter, with the exception of §820.180, with respect to general requirements concerning records, and §820.198, with respect to complaint files.

[52 FR 30097, Aug. 12, 1987, as amended at 59 FR 63008, Dec. 7, 1994; 66 FR 38798, July 25, 2001]

**§ 872.3680 Polytetrafluoroethylene (PTFE) vitreous carbon materials.**

(a) *Identification.* Polytetrafluoroethylene (PTFE) vitreous carbon material is a device composed of polytetrafluoroethylene (PTFE) vitreous carbon intended for use in maxillofacial alveolar ridge augmentation (building up the upper or lower jaw area that contains the sockets in which teeth are rooted) or intended to coat metal surgical implants to be placed in the alveoli (sockets in which the teeth are rooted) or the temporomandibular

joints (the joint between the upper and lower jaws).

(b) *Classification.* Class II.

[52 FR 30097, Aug. 12, 1987; 52 FR 34456, Sept. 11, 1987]

**§ 872.3690 Tooth shade resin material.**

(a) *Identification.* Tooth shade resin material is a device composed of materials such as bisphenol-A glycidyl methacrylate (Bis-GMA) intended to restore carious lesions or structural defects in teeth.

(b) *Classification.* Class II.

**§ 872.3710 Base metal alloy.**

(a) *Identification.* A base metal alloy is a device composed primarily of base metals, such as nickel, chromium, or cobalt, that is intended for use in fabrication of cast or porcelain-fused-to-metal crown and bridge restorations.

(b) *Classification.* Class II (special controls). The special control for this device is FDA’s “Class II Special Controls Guidance Document: Dental Base Metal Alloys.” The device is exempt from the premarket notification procedures in subpart E of part 807 of this chapter subject to the limitations in §872.9. See §872.1(e) for availability of guidance information.

[69 FR 51766, Aug. 23, 2004]

**§ 872.3730 Pantograph.**

(a) *Identification.* A pantograph is a device intended to be attached to a patient’s head to duplicate lower jaw movements to aid in construction of restorative and prosthetic dental devices. A marking pen is attached to the lower jaw component of the device and, as the patient’s mouth opens, the pen records on graph paper the angle between the upper and the lower jaw.

(b) *Classification.* Class I (general controls). The device is exempt from the premarket notification procedures in subpart E of part 807 of this chapter subject to the limitations in §872.9. If the device is not labeled or otherwise represented as sterile, it is exempt from the current good manufacturing practice requirements of the quality system regulation in part 820 of this chapter, with the exception of §820.180, with respect to general requirements

## § 872.3740

concerning records, and § 820.198, with respect to complaint files.

[52 FR 30097, Aug. 12, 1987, as amended at 66 FR 38798, July 25, 2001]

### § 872.3740 Retentive and splinting pin.

(a) *Identification.* A retentive and splinting pin is a device made of austenitic alloys or alloys containing 75 percent or greater gold and metals of the platinum group intended to be placed permanently in a tooth to provide retention and stabilization for a restoration, such as a crown, or to join two or more teeth together.

(b) *Classification.* Class I (general controls). The device is exempt from the premarket notification procedures in subpart E of part 807 of this chapter subject to the limitations in § 872.9

[52 FR 30097, Aug. 12, 1987, as amended at 60 FR 38900, July 28, 1995; 66 FR 38798, July 25, 2001]

### § 872.3750 Bracket adhesive resin and tooth conditioner.

(a) *Identification.* A bracket adhesive resin and tooth conditioner is a device composed of an adhesive compound, such as polymethylmethacrylate, intended to cement an orthodontic bracket to a tooth surface.

(b) *Classification.* Class II.

### § 872.3760 Denture relining, repairing, or rebasing resin.

(a) *Identification.* A denture relining, repairing, or rebasing resin is a device composed of materials such as methylmethacrylate, intended to reline a denture surface that contacts tissue, to repair a fractured denture, or to form a new denture base. This device is not available for over-the-counter (OTC) use.

(b) *Classification.* Class II.

### § 872.3765 Pit and fissure sealant and conditioner.

(a) *Identification.* A pit and fissure sealant and conditioner is a device composed of resin, such as polymethylmethacrylate, intended for use primarily in young children to seal pit and fissure depressions (faults in the enamel) in the biting surfaces of teeth to prevent cavities.

(b) *Classification.* Class II.

## 21 CFR Ch. I (4–1–20 Edition)

### § 872.3770 Temporary crown and bridge resin.

(a) *Identification.* A temporary crown and bridge resin is a device composed of a material, such as polymethylmethacrylate, intended to make a temporary prosthesis, such as a crown or bridge, for use until a permanent restoration is fabricated.

(b) *Classification.* Class II.

### § 872.3810 Root canal post.

(a) *Identification.* A root canal post is a device made of austenitic alloys or alloys containing 75 percent or greater gold and metals of the platinum group intended to be cemented into the root canal of a tooth to stabilize and support a restoration.

(b) *Classification.* Class I (general controls). The device is exempt from the premarket notification procedures in subpart E of part 807 of this chapter subject to the limitations in § 872.9.

[52 FR 30097, Aug. 12, 1987, as amended at 60 FR 38900, July 28, 1995; 66 FR 38798, July 25, 2001]

### § 872.3820 Root canal filling resin.

(a) *Identification.* A root canal filling resin is a device composed of material, such as methylmethacrylate, intended for use during endodontic therapy to fill the root canal of a tooth.

(b) *Classification.* (1) Class II if chloroform is not used as an ingredient in the device.

(2) Class III if chloroform is used as an ingredient in the device.

(c) *Date PMA or notice of completion of a PDP is required.* A PMA or a notice of completion of a PDP is required to be filed with the Food and Drug Administration on or before December 26, 1996 for any root canal filling resin described in paragraph (b)(2) of this section that was in commercial distribution before May 28, 1976, or that has, on or before December 26, 1996 been found to be substantially equivalent to a root canal filling resin described in paragraph (b)(2) of this section that was in commercial distribution before May 28, 1976. Any other root canal filling resin shall have an approved PMA or a declared completed PDP in effect before

**Food and Drug Administration, HHS**

**§ 872.3920**

being placed in commercial distribution.

[52 FR 30097, Aug. 12, 1987, as amended at 61 FR 50707, Sept. 27, 1996]

**§ 872.3830 Endodontic paper point.**

(a) *Identification.* An endodontic paper point is a device made of paper intended for use during endodontic therapy to dry, or apply medication to, the root canal of a tooth.

(b) *Classification.* Class I (general controls). The device is exempt from the premarket notification procedures in subpart E of part 807 of this chapter subject to the limitations in § 872.9.

[52 FR 30097, Aug. 12, 1987, as amended at 54 FR 13830, Apr. 5, 1989; 66 FR 38798, July 25, 2001]

**§ 872.3840 Endodontic silver point.**

(a) *Identification.* An endodontic silver point is a device made of silver intended for use during endodontic therapy to fill permanently the root canal of a tooth.

(b) *Classification.* Class I (general controls). The device is exempt from the premarket notification procedures in subpart E of part 807 of this chapter subject to the limitations in § 872.9.

[52 FR 30097, Aug. 12, 1987, as amended at 54 FR 13830, Apr. 5, 1989; 66 FR 38798, July 25, 2001]

**§ 872.3850 Gutta percha.**

(a) *Identification.* Gutta percha is a device made from coagulated sap of certain tropical trees intended to fill the root canal of a tooth. The gutta percha is softened by heat and inserted into the root canal, where it hardens as it cools.

(b) *Classification.* Class I (general controls). The device is exempt from the premarket notification procedures in subpart E of part 807 of this chapter subject to the limitations in § 872.9.

[52 FR 30097, Aug. 12, 1987, as amended at 54 FR 13830, Apr. 5, 1989; 66 FR 38798, July 25, 2001]

**§ 872.3890 Endodontic stabilizing splint.**

(a) *Identification.* An endodontic stabilizing splint is a device made of a material, such as titanium, intended to be inserted through the root canal into

the upper or lower jaw bone to stabilize a tooth.

(b) *Classification.* Class II (special controls). The device is exempt from the premarket notification procedures in subpart E of part 807 of this chapter subject to the limitations in § 872.9.

[52 FR 30097, Aug. 12, 1987, as amended at 84 FR 71812, Dec. 30, 2019]

**§ 872.3900 Posterior artificial tooth with a metal insert.**

(a) *Identification.* A posterior artificial tooth with a metal insert is a porcelain device with an insert made of austenitic alloys or alloys containing 75 percent or greater gold and metals of the platinum group intended to replace a natural tooth. The device is attached to surrounding teeth by a bridge and is intended to provide both an improvement in appearance and functional occlusion (bite).

(b) *Classification.* Class I (general controls). The device is exempt from the premarket notification procedures in subpart E of part 807 of this chapter subject to the limitations in § 872.9.

[52 FR 30097, Aug. 12, 1987, as amended at 59 FR 63008, Dec. 7, 1994; 66 FR 38798, July 25, 2001]

**§ 872.3910 Backing and facing for an artificial tooth.**

(a) *Identification.* A backing and facing for an artificial tooth is a device intended for use in fabrication of a fixed or removable dental appliance, such as a crown or bridge. The backing, which is made of gold, is attached to the dental appliance and supports the tooth-colored facing, which is made of porcelain or plastic.

(b) *Classification.* Class I (general controls). The device is exempt from the premarket notification procedures in subpart E of part 807 of this chapter subject to the limitations in § 872.9.

[52 FR 30097, Aug. 12, 1987, as amended at 59 FR 63008, Dec. 7, 1994; 66 FR 38799, July 25, 2001]

**§ 872.3920 Porcelain tooth.**

(a) *Identification.* A porcelain tooth is a prefabricated device made of porcelain powder for clinical use

## § 872.3930

(§ 872.6660) intended for use in construction of fixed or removable prostheses, such as crowns and partial dentures.

(b) *Classification*. Class II.

## § 872.3930 Bone grafting material.

(a) *Identification*. Bone grafting material is a material such as hydroxyapatite, tricalcium phosphate, polylactic and polyglycolic acids, or collagen, that is intended to fill, augment, or reconstruct periodontal or bony defects of the oral and maxillo-facial region.

(b) *Classification*. (1) Class II (special controls) for bone grafting materials that do not contain a drug that is a therapeutic biologic. The special control is FDA's "Class II Special Controls Guidance Document: Dental Bone Grafting Material Devices." (See § 872.1(e) for the availability of this guidance document.)

(2) Class III (premarket approval) for bone grafting materials that contain a drug that is a therapeutic biologic. Bone grafting materials that contain a drug that is a therapeutic biologic, such as biological response modifiers, require premarket approval.

(c) *Date premarket approval application (PMA) or notice of product development protocol (PDP) is required*. Devices described in paragraph (b)(2) of this section shall have an approved PMA or a declared completed PDP in effect before being placed in commercial distribution.

[70 FR 21949, Apr. 28, 2005]

## § 872.3940 Total temporomandibular joint prosthesis.

(a) *Identification*. A total temporomandibular joint prosthesis is a device that is intended to be implanted in the human jaw to replace the mandibular condyle and augment the glenoid fossa to functionally reconstruct the temporomandibular joint.

(b) *Classification*. Class III.

(c) *Date PMA or notice of completion of a PDP is required*. A PMA or a notice of completion of a PDP is required to be filed with the Food and Drug Administration on or before March 30, 1999, for any total temporomandibular joint prosthesis that was in commercial distribution before May 28, 1976, or that has, on or before March 30, 1999, been

## 21 CFR Ch. I (4-1-20 Edition)

found to be substantially equivalent to a total temporomandibular joint prosthesis that was in commercial distribution before May 28, 1976. Any other total temporomandibular joint prosthesis shall have an approved PMA or a declared completed PDP in effect before being placed in commercial distribution.

[59 FR 65478, Dec. 20, 1994, as amended at 63 FR 71746, Dec. 30, 1998]

## § 872.3950 Glenoid fossa prosthesis.

(a) *Identification*. A glenoid fossa prosthesis is a device that is intended to be implanted in the temporomandibular joint to augment a glenoid fossa or to provide an articulation surface for the head of a mandibular condyle.

(b) *Classification*. Class III.

(c) *Date PMA or notice of completion of a PDP is required*. A PMA or a notice of completion of a PDP is required to be filed with the Food and Drug Administration on or before March 30, 1999, for any glenoid fossa prosthesis that was in commercial distribution before May 28, 1976, or that has on or before March 30, 1999, been found to be substantially equivalent to a glenoid fossa prosthesis that was in commercial distribution before May 28, 1976. Any other glenoid fossa prosthesis shall have an approved PMA or a declared completed PDP in effect before being placed in commercial distribution.

[59 FR 65478, Dec. 20, 1994, as amended at 63 FR 71746, Dec. 30, 1998]

## § 872.3960 Mandibular condyle prosthesis.

(a) *Identification*. A mandibular condyle prosthesis is a device that is intended to be implanted in the human jaw to replace the mandibular condyle and to articulate within a glenoid fossa.

(b) *Classification*. Class III.

(c) *Date PMA or notice of completion of a PDP is required*. A PMA or a notice of completion of a PDP is required to be filed with the Food and Drug Administration on or before March 30, 1999, for any mandibular condyle prosthesis that was in commercial distribution before May 28, 1976, or that has, on or before March 30, 1999, been found to be



substantially equivalent to a mandibular condyle prosthesis that was in commercial distribution before May 28, 1976. Any other mandibular condyle prosthesis shall have an approved PMA or a declared completed PDP in effect before being placed in commercial distribution.

[59 FR 65478, Dec. 20, 1994, as amended at 63 FR 71746, Dec. 30, 1998; 78 FR 79310, Dec. 30, 2013]

**§ 872.3970 Interarticular disc prosthesis (interpositional implant).**

(a) *Identification.* An interarticular disc prosthesis (interpositional implant) is a device that is intended to be an interface between the natural articulating surface of the mandibular condyle and glenoid fossa.

(b) *Classification.* Class III.

(c) *Date PMA or notice of completion of a PDP is required.* A PMA or a notice of completion of a PDP is required to be filed with the Food and Drug Administration on or before March 30, 1999, for any interarticular disc prosthesis (interpositional implant) that was in commercial distribution before May 28, 1976, or that has on or before March 30, 1999, been found to be substantially equivalent to an interarticular disc prosthesis (interpositional implant) that was in commercial distribution before May 28, 1976. Any other interarticular disc prosthesis (interpositional implant) shall have an approved PMA or a declared completed PDP in effect before being placed in commercial distribution.

[59 FR 65478, Dec. 20, 1994, as amended at 63 FR 71746, Dec. 30, 1998]

**§ 872.3980 Endosseous dental implant accessories.**

(a) *Identification.* Endosseous dental implant accessories are manually powered devices intended to aid in the placement or removal of endosseous dental implants and abutments, prepare the site for placement of endosseous dental implants or abutments, aid in the fitting of endosseous dental implants or abutments, aid in the fabrication of dental prosthetics, and be used as an accessory with endosseous dental implants when tissue contact will last less than 1 hour. These devices include drill bits, screw-

drivers, countertorque devices, placement and removal tools, laboratory pieces used for fabrication of dental prosthetics, and trial abutments.

(b) *Classification.* Class I (general controls). The device is exempt from the premarket notification procedures in subpart E of part 807 of this chapter subject to the limitations in § 872.9.

[65 FR 60099, Oct. 10, 2000]

**Subpart E—Surgical Devices**

**§ 872.4120 Bone cutting instrument and accessories.**

(a) *Identification.* A bone cutting instrument and accessories is a metal device intended for use in reconstructive oral surgery to drill or cut into the upper or lower jaw and may be used to prepare bone to insert a wire, pin, or screw. The device includes the manual bone drill and wire driver, powered bone drill, rotary bone cutting handpiece, and AC-powered bone saw.

(b) *Classification.* Class II.

**§ 872.4130 Intraoral dental drill.**

(a) *Identification.* An intraoral dental drill is a rotary device intended to be attached to a dental handpiece to drill holes in teeth to secure cast or preformed pins to retain operative dental appliances.

(b) *Classification.* Class I (general controls). The device is exempt from the premarket notification procedures in subpart E of part 807 of this chapter subject to the limitations in § 872.9.

[52 FR 30097, Aug. 12, 1987, as amended at 59 FR 63008, Dec. 7, 1994; 66 FR 38799, July 25, 2001]

**§ 872.4200 Dental handpiece and accessories.**

(a) *Identification.* A dental handpiece and accessories is an AC-powered, water-powered, air-powered, or belt-driven, hand-held device that may include a foot controller for regulation of speed and direction of rotation or a contra-angle attachment for difficult to reach areas intended to prepare dental cavities for restorations, such as fillings, and for cleaning teeth.

(b) *Classification.* Class I.

[55 FR 48439, Nov. 20, 1990]

**§ 872.4465**

**21 CFR Ch. I (4-1-20 Edition)**

**§ 872.4465 Gas-powered jet injector.**

(a) *Identification.* A gas-powered jet injector is a syringe device intended to administer a local anesthetic. The syringe is powered by a cartridge containing pressurized carbon dioxide which provides the pressure to force the anesthetic out of the syringe.

(b) *Classification.* Class II.

**§ 872.4475 Spring-powered jet injector.**

(a) *Identification.* A spring-powered jet injector is a syringe device intended to administer a local anesthetic. The syringe is powered by a spring mechanism which provides the pressure to force the anesthetic out of the syringe.

(b) *Classification.* Class II.

**§ 872.4535 Dental diamond instrument.**

(a) *Identification.* A dental diamond instrument is an abrasive device intended to smooth tooth surfaces during the fitting of crowns or bridges. The device consists of a shaft which is inserted into a handpiece and a head which has diamond chips imbedded into it. Rotation of the diamond instrument provides an abrasive action when it contacts a tooth.

(b) *Classification.* Class I. The device is exempt from the premarket notification procedures in subpart E of part 807 of this chapter.

[52 FR 30097, Aug. 12, 1987, as amended at 59 FR 63008, Dec. 7, 1994]

**§ 872.4565 Dental hand instrument.**

(a) *Identification.* A dental hand instrument is a hand-held device intended to perform various tasks in general dentistry and oral surgery procedures. The device includes the operative burnisher, operative amalgam carrier, operative dental amalgam carver, surgical bone chisel, operative amalgam and foil condenser, endodontic curette, operative curette, periodontic curette, surgical curette, dental surgical elevator, operative dental excavator, operative explorer surgical bone file, operative margin finishing file, periodontic file, periodontic probe, surgical rongeur forceps, surgical tooth extractor forceps, surgical hemostat, periodontic hoe, operative matrix contouring instrument, operative cutting instrument, operative margin finishing periodontic knife, periodontic marker, operative pliers, endodontic root canal plugger, endodontic root canal preparer, surgical biopsy punch, endodontic pulp canal reamer, crown remover, periodontic scaler, collar and crown scissors, endodontic pulp canal filling material spreader, surgical osteotome chisel, endodontic broach, dental wax carver, endodontic pulp canal file, hand instrument for calculus removal, dental depth gauge instrument, plastic dental filling instrument, dental instrument handle, surgical tissue scissors, mouth mirror, orthodontic band driver, orthodontic band pusher, orthodontic band setter, orthodontic bracket aligner, orthodontic pliers, orthodontic ligature tucking instrument, forceps, for articulation paper, forceps for dental dressing, dental matrix band, matrix retainer, dental retractor, dental retractor accessories, periodontic or endodontic irrigating syringe, and restorative or impression material syringe.

(b) *Classification.* Class I (general controls). If the device is made of the same materials that were used in the device before May 28, 1976, it is exempt from the premarket notification procedures in subpart E of part 807 of this chapter subject to the limitations in § 872.9.

[52 FR 30097, Aug. 12, 1987, as amended at 54 FR 13830, Apr. 5, 1989; 66 FR 38799, July 25, 2001]

**§ 872.4600 Intraoral ligature and wire lock.**

(a) *Identification.* An intraoral ligature and wire lock is a metal device intended to constrict fractured bone segments in the oral cavity. The bone segments are stabilized by wrapping the ligature (wire) around the fractured bone segments and locking the ends together.

(b) *Classification.* Class II.

**§ 872.4620 Fiber optic dental light.**

(a) *Identification.* A fiber optic dental light is a device that is a light, usually AC-powered, that consists of glass or plastic fibers which have special optical properties. The device is usually attached to a dental handpiece and is intended to illuminate a patient's oral structures.

(b) *Classification*. Class I (general controls). The device is exempt from the premarket notification procedures in subpart E of part 807 of this chapter subject to the limitations in § 872.9.

[55 FR 48439, Nov. 20, 1990, as amended at 59 FR 63008, Dec. 7, 1994; 66 FR 38799, July 25, 2001]

**§ 872.4630 Dental operating light.**

(a) *Identification*. A dental operating light, including the surgical headlight, is an AC-powered device intended to illuminate oral structures and operating areas.

(b) *Classification*. Class I (general controls). The device is exempt from the premarket notification procedures in subpart E of part 807 of this chapter subject to the limitations in § 872.9.

[52 FR 30097, Aug. 12, 1987, as amended at 61 FR 1121, Jan. 16, 1996; 66 FR 38799, July 25, 2001]

**§ 872.4730 Dental injecting needle.**

(a) *Identification*. A dental injecting needle is a slender, hollow metal device with a sharp point intended to be attached to a syringe to inject local anesthetics and other drugs.

(b) *Classification*. Class I (general controls). The device is exempt from the premarket notification procedures in subpart E of part 807 of this chapter subject to the limitations in § 872.9.

[52 FR 30097, Aug. 12, 1987, as amended at 59 FR 63008, Dec. 7, 1994; 66 FR 38799, July 25, 2001]

**§ 872.4760 Bone plate.**

(a) *Identification*. A bone plate is a metal device intended to stabilize fractured bone structures in the oral cavity. The bone segments are attached to the plate with screws to prevent movement of the segments.

(b) *Classification*. Class II.

**§ 872.4770 Temporary mandibular condyle reconstruction plate.**

(a) *Identification*. A temporary mandibular condyle reconstruction plate is a device that is intended to stabilize mandibular bone and provide for temporary reconstruction of the mandibular condyle until permanent reconstruction is completed in patients who have undergone resective surgical pro-

cedures requiring removal of the mandibular condyle and mandibular bone. This device is not intended for treatment of temporomandibular joint disorders.

(b) *Classification*. Class II (special controls). The special controls for this device is FDA's guideline entitled "Temporary Mandibular Condyle Reconstruction Plate Class II Special Controls Guideline." See § 872.1(e) for the availability of this guidance document.

[78 FR 79310, Dec. 30, 2013]

**§ 872.4840 Rotary scaler.**

(a) *Identification*. A rotary scaler is an abrasive device intended to be attached to a powered handpiece to remove calculus deposits from teeth during dental cleaning and periodontal (gum) therapy.

(b) *Classification*. Class II.

**§ 872.4850 Ultrasonic scaler.**

(a) *Identification*. An ultrasonic scaler is a device intended for use during dental cleaning and periodontal (gum) therapy to remove calculus deposits from teeth by application of an ultrasonic vibrating scaler tip to the teeth.

(b) *Classification*. Class II.

**§ 872.4880 Intraosseous fixation screw or wire.**

(a) *Identification*. An intraosseous fixation screw or wire is a metal device intended to be inserted into fractured jaw bone segments to prevent their movement.

(b) *Classification*. Class II.

**§ 872.4920 Dental electrosurgical unit and accessories.**

(a) *Identification*. A dental electrosurgical unit and accessories is an AC-powered device consisting of a controlled power source and a set of cutting and coagulating electrodes. This device is intended to cut or remove soft tissue or to control bleeding during surgical procedures in the oral cavity. An electrical current passes through the tip of the electrode into the tissue and, depending upon the operating mode selected, cuts through soft tissue or coagulates the tissue.

(b) *Classification*. Class II.

**Subpart F—Therapeutic Devices****§ 872.5410 Orthodontic appliance and accessories.**

(a) *Identification.* An orthodontic appliance and accessories is a device intended for use in orthodontic treatment. The device is affixed to a tooth so that pressure can be exerted on the teeth. This device includes the preformed orthodontic band, orthodontic band material, orthodontic elastic band, orthodontic metal bracket, orthodontic wire clamp, preformed orthodontic space maintainer, orthodontic expansion screw retainer, orthodontic spring, orthodontic tube, and orthodontic wire.

(b) *Classification.* Class I (general controls). The device is exempt from the premarket notification procedures in subpart E of part 807 of this chapter subject to the limitations in § 872.9.

[52 FR 30097, Aug. 12, 1987, as amended at 59 FR 63009, Dec. 7, 1994; 66 FR 38799, July 25, 2001]

**§ 872.5470 Orthodontic plastic bracket.**

(a) *Identification.* An orthodontic plastic bracket is a plastic device intended to be bonded to a tooth to apply pressure to a tooth from a flexible orthodontic wire to alter its position.

(b) *Classification.* Class II.

**§ 872.5500 Extraoral orthodontic headgear.**

(a) *Identification.* An extraoral orthodontic headgear is a device intended for use with an orthodontic appliance to exert pressure on the teeth from outside the mouth. The headgear has a strap intended to wrap around the patient's neck or head and an inner bow portion intended to be fastened to the orthodontic appliance in the patient's mouth.

(b) *Classification.* Class II.

**§ 872.5525 Preformed tooth positioner.**

(a) *Identification.* A preformed tooth positioner is a plastic device that is an impression of a perfected bite intended to prevent a patient's teeth from shifting position or to move teeth to a final position after orthodontic appliances (braces) have been removed. The patient bites down on the device for several hours a day to force the teeth into

a final position or to maintain the teeth in their corrected position.

(b) *Classification.* Class I (general controls). The device is exempt from the premarket notification procedures in subpart E of part 807 of this chapter subject to the limitations in § 872.9.

[52 FR 30097, Aug. 12, 1987, as amended at 59 FR 63009, Dec. 7, 1994; 66 FR 38799, July 25, 2001]

**§ 872.5550 Teething ring.**

(a) *Identification.* A teething ring is a device intended for use by infants for medical purposes to soothe gums during the teething process.

(b)(1) *Classification.* Class I if the teething ring does not contain a fluid, such as water. The device is exempt from the premarket notification procedures in subpart E of part 807 of this chapter.

(2) Class II (special controls) if the teething ring contains a fluid, such as water. The device is exempt from the premarket notification procedures in subpart E of part 807 of this chapter subject to the limitations in § 872.9.

[52 FR 30097, Aug. 12, 1987, as amended at 59 FR 63009, Dec. 7, 1994; 84 FR 71812, Dec. 30, 2019]

**§ 872.5560 Electrical salivary stimulatory system.**

(a) *Identification.* An electrical salivary stimulatory system is a prescription intraoral device that is intended to electrically stimulate a relative increase in saliva production.

(b) *Classification*—Class II (special controls). The special controls for this device are:

(1) The design characteristics of the device must ensure that the device design, material composition, and electrical output characteristics are consistent with the intended use;

(2) Any element of the device that contacts the patient must be demonstrated to be biocompatible;

(3) Appropriate analysis and/or testing must validate electromagnetic compatibility and electrical safety, including the safety of any battery used in the device;

(4) Software validation, verification, and hazard testing must be performed; and

(5) Documented clinical experience must demonstrate safe and effective use for stimulating saliva production by addressing the risks of damage to intraoral tissue and of ineffective treatment and must capture any adverse events observed during clinical use.

[80 FR 72586, Nov. 22, 2015]

**§ 872.5570 Intraoral devices for snoring and intraoral devices for snoring and obstructive sleep apnea.**

(a) *Identification.* Intraoral devices for snoring and intraoral devices for snoring and obstructive sleep apnea are devices that are worn during sleep to reduce the incidence of snoring and to treat obstructive sleep apnea. The devices are designed to increase the patency of the airway and to decrease air turbulence and airway obstruction. The classification includes palatal lifting devices, tongue retaining devices, and mandibular repositioning devices.

(b) *Classification.* Class II (special controls). The special control for these devices is the FDA guidance document entitled “Class II Special Controls Guidance Document: Intraoral Devices for Snoring and/or Obstructive Sleep Apnea; Guidance for Industry and FDA.”

[67 FR 68512, Nov. 12, 2002]

**§ 872.5571 Auto titration device for oral appliances.**

(a) *Identification.* An auto-titration device for oral appliances is a prescription home use device that determines a target position to be used for a final oral appliance for the reduction of snoring and mild to moderate obstructive sleep apnea.

(b) *Classification.* Class II (special controls). The special controls for this device are:

(1) Clinical performance testing must evaluate the following:

(i) Performance characteristics of the algorithm; and

(ii) All adverse events.

(2) Non-clinical performance testing must demonstrate that the device performs as intended under anticipated conditions for use, including the following:

(i) Validation of the closed loop algorithm;

(ii) Mechanical integrity over the expected use life;

(iii) Characterization of maximum force, distance, and speed of device movement; and

(iv) Movement accuracy of intraoral components.

(3) Performance testing must demonstrate the wireless compatibility, electrical safety, and electromagnetic compatibility of the device in its intended use environment.

(4) Software verification, validation, and hazard analysis must be performed.

(5) The patient-contacting components of the device must be demonstrated to be biocompatible.

(6) Performance data must validate the reprocessing instructions for any reusable components.

(7) Patient labeling must include:

(i) Information on device use, including placement of sensors and mouthpieces;

(ii) A description of all alarms; and

(iii) Instructions for reprocessing any reusable components.

(8) A human factors assessment must evaluate simulated use of the device in a home use setting.

[84 FR 5000, Feb. 20, 2019]

**§ 872.5580 Oral rinse to reduce the adhesion of dental plaque.**

(a) *Identification.* The device is assigned the generic name oral rinse to reduce the adhesion of dental plaque and is identified as a device intended to reduce the presence of bacterial plaque on teeth and oral mucosal surfaces by physical means. The device type includes those devices that act by reducing the attachment and inhibiting the growth of bacterial plaque.

(b) *Classification.* Class II (special controls). The special control is FDA’s guidance document entitled “Class II Special Controls Guidance Document: Oral Rinse to Reduce the Adhesion of Dental Plaque.” See § 872.1(e) for the availability of this guidance document.

[70 FR 55028, Sept. 20, 2005]

### Subpart G—Miscellaneous Devices

#### § 872.6010 Abrasive device and accessories.

(a) *Identification.* An abrasive device and accessories is a device constructed of various abrasives, such as diamond chips, that are glued to shellac-based paper. The device is intended to remove excessive restorative materials, such as gold, and to smooth rough surfaces from oral restorations, such as crowns. The device is attached to a shank that is held by a handpiece. The device includes the abrasive disk, guard for an abrasive disk, abrasive point, polishing agent strip, and polishing wheel.

(b) *Classification.* Class I (general controls). The device is exempt from the premarket notification procedures in subpart E of part 807 of this chapter subject to the limitations in § 872.9. If the device is not labeled or otherwise represented as sterile, it is exempt from the current good manufacturing practice requirements of the quality system regulation in part 820 of this chapter, with the exception of § 820.180, with respect to general requirements concerning records, and § 820.198, with respect to complaint files.

[52 FR 30097, Aug. 12, 1987, as amended at 54 FR 13830, Apr. 5, 1989; 66 FR 38799, July 25, 2001]

#### § 872.6030 Oral cavity abrasive polishing agent.

(a) *Identification.* An oral cavity abrasive polishing agent is a device in paste or powder form that contains an abrasive material, such as silica pumice, intended to remove debris from the teeth. The abrasive polish is applied to the teeth by a handpiece attachment (prophylaxis cup).

(b) *Classification.* Class I (general controls). The device is exempt from the premarket notification procedures in subpart E of part 807 of this chapter subject to the limitations in § 872.9.

[52 FR 30097, Aug. 12, 1987, as amended at 59 FR 63009, Dec. 7, 1994; 66 FR 38799, July 25, 2001]

#### § 872.6050 Saliva absorber.

(a) *Identification.* A saliva absorber is a device made of paper or cotton intended to absorb moisture from the oral cavity during dental procedures.

(b) *Classification.* Class I (general controls). The device is exempt from the premarket notification procedures in subpart E of part 807 of this chapter subject to the limitations in § 872.9. If the device is not labeled or otherwise represented as sterile, it is exempt from the current good manufacturing practice requirements of the quality system regulation in part 820 of this chapter, with the exception of § 820.180, with respect to general requirements concerning records, and § 820.198, with respect to complaint files.

[52 FR 30097, Aug. 12, 1987, as amended at 54 FR 13830, Apr. 5, 1989; 66 FR 38799, July 25, 2001]

#### § 872.6070 Ultraviolet activator for polymerization.

(a) *Identification.* An ultraviolet activator for polymerization is a device that produces ultraviolet radiation intended to polymerize (set) resinous dental pit and fissure sealants or restorative materials by transmission of light through a rod.

(b) *Classification.* Class II.

#### § 872.6080 Airbrush.

(a) *Identification.* An airbrush is an AC-powered device intended for use in conjunction with articulation paper. The device uses air-driven particles to roughen the surfaces of dental restorations. Uneven areas of the restorations are then identified by use of articulation paper.

(b) *Classification.* Class II. The special control for this device is International Electrotechnical Commission's IEC 60601-1-AM2 (1995-03), Amendment 2, "Medical Electrical Equipment—Part 1: General Requirements for Safety."

[52 FR 30097, Aug. 12, 1987; 52 FR 49250, Dec. 30, 1987, as amended at 71 FR 17144, Mar. 31, 2006]

#### § 872.6100 Anesthetic warmer.

(a) *Identification.* An anesthetic warmer is an AC-powered device into which tubes containing anesthetic solution are intended to be placed to

warm them prior to administration of the anesthetic.

(b) *Classification*. Class I (general controls). The device is exempt from the premarket notification procedures in subpart E of part 807 of this chapter subject to the limitations in § 872.9.

[52 FR 30097, Aug. 12, 1987, as amended at 60 FR 38900, July 28, 1995; 66 FR 38799, July 25, 2001]

#### § 872.6140 Articulation paper.

(a) *Identification*. Articulation paper is a device composed of paper coated with an ink dye intended to be placed between the patient's upper and lower teeth when the teeth are in the bite position to locate uneven or high areas.

(b) *Classification*. Class I (general controls). The device is exempt from the premarket notification procedures in subpart E of part 807 of this chapter subject to the limitations in § 872.9. If the device is not labeled or otherwise represented as sterile, it is exempt from the current good manufacturing practice requirements of the quality system regulation in part 820 of this chapter, with the exception of § 820.180, with respect to general requirements concerning records, and § 820.198, with respect to complaint files.

[52 FR 30097, Aug. 12, 1987, as amended at 59 FR 63009, Dec. 7, 1994; 66 FR 38799, July 25, 2001]

#### § 872.6200 Base plate shellac.

(a) *Identification*. Base plate shellac is a device composed of shellac intended to rebuild the occlusal rim of full or partial dentures.

(b) *Classification*. Class I (general controls). The device is exempt from the premarket notification procedures in subpart E of part 807 of this chapter subject to the limitations in § 872.9. If the device is not labeled or otherwise represented as sterile, it is exempt from the current good manufacturing practice requirements of the quality system regulation in part 820 of this chapter, with the exception of § 820.180, with respect to general requirements concerning records, and § 820.198, with respect to complaint files.

[52 FR 30097, Aug. 12, 1987, as amended at 54 FR 13830, Apr. 5, 1989; 66 FR 38799, July 25, 2001]

#### § 872.6250 Dental chair and accessories.

(a) *Identification*. A dental chair and accessories is a device, usually AC-powered, in which a patient sits. The device is intended to properly position a patient to perform dental procedures. A dental operative unit may be attached.

(b) *Classification*. Class I. The dental chair without the operative unit device is exempt from the premarket notification procedures in subpart E of part 807 of this chapter.

[55 FR 48439, Nov. 20, 1990, as amended at 59 FR 63009, Dec. 7, 1994]

#### § 872.6290 Prophylaxis cup.

(a) *Identification*. A prophylaxis cup is a device made of rubber intended to be held by a dental handpiece and used to apply polishing agents during prophylaxis (cleaning). The dental handpiece spins the rubber cup holding the polishing agent and the user applies it to the teeth to remove debris.

(b) *Classification*. Class I (general controls). The device is exempt from the premarket notification procedures in subpart E of part 807 of this chapter subject to the limitations in § 872.9. If the device is not labeled or otherwise represented as sterile, it is exempt from the current good manufacturing practice requirements of the quality system regulation in part 820 of this chapter, with the exception of § 820.180, with respect to general requirements concerning records, and § 820.198, with respect to complaint files.

[52 FR 30097, Aug. 12, 1987, as amended at 54 FR 13831, Apr. 5, 1989; 66 FR 38799, July 25, 2001]

#### § 872.6300 Rubber dam and accessories.

(a) *Identification*. A rubber dam and accessories is a device composed of a thin sheet of latex with a hole in the center intended to isolate a tooth from fluids in the mouth during dental procedures, such as filling a cavity preparation. The device is stretched around a tooth by inserting a tooth through a hole in the center. The device includes the rubber dam, rubber dam clamp, rubber dam frame, and forceps for a rubber dam clamp. This classification

## § 872.6350

does not include devices intended for use in preventing transmission of sexually transmitted diseases through oral sex; those devices are classified as condoms in § 884.5300 of this chapter.

(b) *Classification*. Class I (general controls). The device is exempt from the premarket notification procedures in subpart E of part 807 of this chapter subject to § 872.9. If the device is not labeled or otherwise represented as sterile, it is exempt from the current good manufacturing practice requirements of the quality system regulation in part 820 of this chapter, with the exception of § 820.180 of this chapter, with respect to general requirements concerning records, and § 820.198 of this chapter, with respect to complaint files.

[65 FR 2315, Jan. 14, 2000]

## § 872.6350 Ultraviolet detector.

(a) *Identification*. An ultraviolet detector is a device intended to provide a source of ultraviolet light which is used to identify otherwise invisible material, such as dental plaque, present in or on teeth.

(b) *Classification*. Class II.

## § 872.6390 Dental floss.

(a) *Identification*. Dental floss is a string-like device made of cotton or other fibers intended to remove plaque and food particles from between the teeth to reduce tooth decay. The fibers of the device may be coated with wax for easier use.

(b) *Classification*. Class I (general controls). The device is exempt from the premarket notification procedures in subpart E of part 807 of this chapter subject to § 872.9.

[52 FR 30097, Aug. 12, 1987, as amended at 61 FR 1121, Jan. 16, 1996; 65 FR 2315, Jan. 14, 2000]

## § 872.6475 Heat source for bleaching teeth.

(a) *Identification*. A heat source for bleaching teeth is an AC-powered device that consists of a light or an electric heater intended to apply heat to a tooth after it is treated with a bleaching agent.

(b) *Classification*. Class I (general controls). The device is exempt from the

## 21 CFR Ch. I (4-1-20 Edition)

premarket notification procedures in subpart E of part 807 of this chapter subject to the limitations in § 872.9.

[55 FR 48439, Nov. 20, 1990, as amended at 59 FR 63009, Dec. 7, 1994; 66 FR 38799, July 25, 2001]

## § 872.6510 Oral irrigation unit.

(a) *Identification*. An oral irrigation unit is an AC-powered device intended to provide a pressurized stream of water to remove food particles from between the teeth and promote good periodontal (gum) condition.

(b) *Classification*. Class I (general controls). The device is exempt from the premarket notification procedures in subpart E of part 807 of this chapter subject to the limitations in § 872.9.

[55 FR 48439, Nov. 20, 1990, as amended at 59 FR 63009, Dec. 7, 1994; 66 FR 38800, July 25, 2001]

## § 872.6570 Impression tube.

(a) *Identification*. An impression tube is a device consisting of a hollow copper tube intended to take an impression of a single tooth. The hollow tube is filled with impression material. One end of the tube is sealed with a softened material, such as wax, the remaining end is slipped over the tooth to make the impression.

(b) *Classification*. Class I (general controls). The device is exempt from the premarket notification procedures in subpart E of part 807 of this chapter subject to the limitations in § 872.9. If the device is not labeled or otherwise represented as sterile, it is exempt from the current good manufacturing practice requirements of the quality system regulation in part 820 of this chapter, with the exception of § 820.180, with respect to general requirements concerning records, and § 820.198, with respect to complaint files.

[52 FR 30097, Aug. 12, 1987, as amended at 54 FR 13831, Apr. 5, 1989; 66 FR 38800, July 25, 2001]

## § 872.6640 Dental operative unit and accessories.

(a) *Identification*. A dental operative unit and accessories is an AC-powered device that is intended to supply power to and serve as a base for other dental devices, such as a dental handpiece, a



dental operating light, an air or water syringe unit, and oral cavity evacuator, a suction operative unit, and other dental devices and accessories. The device may be attached to a dental chair.

(b) *Classification*. Class I (general controls). Except for dental operative unit, accessories are exempt from premarket notification procedures in subpart E of part 807 of this chapter subject to § 872.9.

[55 FR 48439, Nov. 20, 1990, as amended at 59 FR 63009, Dec. 7, 1994; 65 FR 2315, Jan. 14, 2000]

**§ 872.6650 Massaging pick or tip for oral hygiene.**

(a) *Identification*. A massaging pick or tip for oral hygiene is a rigid, pointed device intended to be used manually to stimulate and massage the gums to promote good periodontal (gum) condition.

(b) *Classification*. Class I (general controls). The device is exempt from the premarket notification procedures in subpart E of part 807 of this chapter subject to the limitations in § 872.9. If the device is not labeled or otherwise represented as sterile, it is exempt from the current good manufacturing practice requirements of the quality system regulation in part 820 of this chapter, with the exception of § 820.180, with respect to general requirements concerning records, and § 820.198, with respect to complaint files.

[52 FR 30097, Aug. 12, 1987, as amended at 54 FR 13831, Apr. 5, 1989; 66 FR 38800, July 25, 2001]

**§ 872.6660 Porcelain powder for clinical use.**

(a) *Identification*. Porcelain powder for clinical use is a device consisting of a mixture of kaolin, felspar, quartz, or other substances intended for use in the production of artificial teeth in fixed or removable dentures, of jacket crowns, facings, and veneers. The device is used in prosthetic dentistry by heating the powder mixture to a high temperature in an oven to produce a hard prosthesis with a glass-like finish.

(b) *Classification*. Class II.

**§ 872.6670 Silicate protector.**

(a) *Identification*. A silicate protector is a device made of silicone intended to be applied with an absorbent tipped applicator to the surface of a new restoration to exclude temporarily fluids from its surface.

(b) *Classification*. Class I (general controls). The device is exempt from the premarket notification procedures in subpart E of part 807 of this chapter subject to the limitations in § 872.9. If the device is not labeled or otherwise represented as sterile, it is exempt from the current good manufacturing practice requirements of the quality system regulation in part 820 of this chapter, with the exception of § 820.180, with respect to general requirements concerning records, and § 820.198, with respect to complaint files.

[52 FR 30097, Aug. 12, 1987, as amended at 54 FR 13831, Apr. 5, 1989; 66 FR 38800, July 25, 2001]

**§ 872.6710 Boiling water sterilizer.**

(a) *Identification*. A boiling water sterilizer is an AC-powered device that consists of a container for boiling water. The device is intended to sterilize dental and surgical instruments by submersion in the boiling water in the container.

(b) *Classification*. Class I (general controls).

[55 FR 48439, Nov. 20, 1990, as amended at 66 FR 46952, Sept. 10, 2001]

**§ 872.6730 Endodontic dry heat sterilizer.**

(a) *Identification*. An endodontic dry heat sterilizer is a device intended to sterilize endodontic and other dental instruments by the application of dry heat. The heat is supplied through glass beads which have been heated by electricity.

(b) *Classification*. Class III.

(c) *Date premarket approval application (PMA) or notice of completion of product development protocol (PDP) is required*. A PMA or notice of completion of a PDP is required to be filed with the Food and Drug Administration on or before April 21, 1997, for any endodontic dry heat sterilizer that was in commercial distribution before May 28, 1976, or that has on or before April 21, 1997, been

## § 872.6770

found to be substantially equivalent to the endodontic dry heat sterilizer that was in commercial distribution before May 28, 1976. Any other endodontic dry heat sterilizer shall have an approved PMA or declared completed PDP in effect before being placed in commercial distribution.

[52 FR 30097, Aug. 12, 1987, as amended at 62 FR 2902, Jan. 21, 1997; 62 FR 31512, June 10, 1997]

### § 872.6770 Cartridge syringe.

(a) *Identification.* A cartridge syringe is a device intended to inject anesthetic agents subcutaneously or intramuscularly. The device consists of a metal syringe body into which a disposable, previously filled, glass carpule (a cylindrical cartridge) containing anesthetic is placed. After attaching a needle to the syringe body and activating the carpule by partially inserting the plunger on the syringe, the device is used to administer an injection to the patient.

(b) *Classification.* Class II (special controls). The device is exempt from the premarket notification procedures in subpart E of part 807 of this chapter subject to the limitations in § 872.9.

[52 FR 30097, Aug. 12, 1987, as amended at 84 FR 71813, Dec. 30, 2019]

### § 872.6855 Manual toothbrush.

(a) *Identification.* A manual toothbrush is a device composed of a shaft with either natural or synthetic bristles at one end intended to remove adherent plaque and food debris from the teeth to reduce tooth decay.

(b) *Classification.* Class I (general controls). The device is exempt from the premarket notification procedures in subpart E of part 807 of this chapter subject to the limitations in § 872.9. If the device is not labeled or otherwise represented as sterile, it is exempt from the current good manufacturing practice requirements of the quality system regulation in part 820 of this chapter, with the exception of § 820.180, with respect to general requirements concerning records, and § 820.198, with respect to complaint files.

[52 FR 30097, Aug. 12, 1987, as amended at 54 FR 13831, Apr. 5, 1989; 66 FR 38800, July 25, 2001]

## 21 CFR Ch. I (4–1–20 Edition)

### § 872.6865 Powered toothbrush.

(a) *Identification.* A powered toothbrush is an AC-powered or battery-powered device that consists of a handle containing a motor that provides mechanical movement to a brush intended to be applied to the teeth. The device is intended to remove adherent plaque and food debris from the teeth to reduce tooth decay.

(b) *Classification.* Class I (general controls). The device is exempt from the premarket notification procedures in subpart E of part 807 of this chapter subject to the limitations in § 872.9.

[55 FR 48440, Nov. 20, 1990, as amended at 59 FR 63009, Dec. 7, 1994; 66 FR 38800, July 25, 2001]

### § 872.6870 Disposable fluoride tray.

(a) *Identification.* A disposable fluoride tray is a device made of styrofoam intended to apply fluoride topically to the teeth. To use the tray, the patient bites down on the tray which has been filled with a fluoride solution.

(b) *Classification.* Class I (general controls). The device is exempt from the premarket notification procedures in subpart E of part 807 of this chapter subject to the limitations in § 872.9. If the device is not labeled or otherwise represented as sterile, it is exempt from the current good manufacturing practice requirements of the quality system regulation in part 820 of this chapter, with the exception of § 820.180, with respect to general requirements concerning records, and § 820.198, with respect to complaint files.

[52 FR 30097, Aug. 12, 1987, as amended at 54 FR 13831, Apr. 5, 1989; 66 FR 38800, July 25, 2001]

### § 872.6880 Preformed impression tray.

(a) *Identification.* A preformed impression tray is a metal or plastic device intended to hold impression material, such as alginate, to make an impression of a patient's teeth or alveolar process (bony tooth sockets) to reproduce the structure of a patient's teeth and gums.

(b) *Classification.* Class I (general controls). The device is exempt from the premarket notification procedures in subpart E of part 807 of this chapter subject to the limitations in § 872.9. If

the device is not labeled or otherwise represented as sterile, it is exempt from the current good manufacturing practice requirements of the quality system regulation in part 820 of this chapter, with the exception of §820.180, with respect to general requirements concerning records, and §820.198, with respect to complaint files.

[52 FR 30097, Aug. 12, 1987, as amended at 54 FR 13832, Apr. 5, 1989; 66 FR 38800, July 25, 2001]

#### § 872.6890 Intraoral dental wax.

(a) *Identification.* Intraoral dental wax is a device made of wax intended to construct patterns from which custom made metal dental prostheses, such as crowns and bridges, are cast. In orthodontic dentistry, the device is intended to make a pattern of a patient's bite to make study models of the teeth.

(b) *Classification.* Class I (general controls). The device is exempt from the premarket notification procedures in subpart E of part 807 of this chapter subject to the limitations in §872.9. If the device is not labeled or otherwise represented as sterile, it is exempt from the current good manufacturing practice requirements of the quality system regulation in part 820 of this chapter, with the exception of §820.180, with respect to general requirements concerning records, and §820.198, with respect to complaint files.

[52 FR 30097, Aug. 12, 1987, as amended at 59 FR 63009, Dec. 7, 1994; 66 FR 38800, July 25, 2001]

## PART 874—EAR, NOSE, AND THROAT DEVICES

### Subpart A—General Provisions

Sec.

874.1 Scope.

874.3 Effective dates of requirement for premarket approval.

874.9 Limitations of exemptions from section 510(k) of the Federal Food, Drug, and Cosmetic Act (the act).

### Subpart B—Diagnostic Devices

874.1050 Audiometer.

874.1060 Acoustic chamber for audiometric testing.

874.1070 Short increment sensitivity index (SISI) adapter.

874.1080 Audiometer calibration set.

874.1090 Auditory impedance tester.

874.1100 Earphone cushion for audiometric testing.

874.1120 Electronic noise generator for audiometric testing.

874.1325 Electroglottograph.

874.1500 Gustometer.

874.1600 Olfactory test device.

874.1800 Air or water caloric stimulator.

874.1820 Surgical nerve stimulator/locator.

874.1925 Toybee diagnostic tube.

### Subpart C [Reserved]

### Subpart D—Prosthetic Devices

874.3300 Hearing aid.

874.3305 Wireless air-conduction hearing aid.

874.3310 Hearing aid calibrator and analysis system.

874.3315 Tympanic membrane contact hearing aid.

874.3320 Group hearing aid or group auditory trainer.

874.3325 Self-fitting air-conduction hearing aid.

874.3330 Master hearing aid.

874.3340 Active implantable bone conduction hearing system.

874.3375 Battery-powered artificial larynx.

874.3400 Tinnitus masker.

874.3430 Middle ear mold.

874.3450 Partial ossicular replacement prosthesis.

874.3495 Total ossicular replacement prosthesis.

874.3540 Prosthesis modification instrument for ossicular replacement surgery.

874.3620 Ear, nose, and throat synthetic polymer material.

874.3695 Mandibular implant facial prosthesis.

874.3730 Laryngeal prosthesis (Taub design).

874.3760 Sacculotomy tack (Cody tack).

874.3820 Endolymphatic shunt.

874.3850 Endolymphatic shunt tube with valve.

874.3880 Tympanostomy tube.

874.3900 Nasal dilator.

874.3930 Tympanostomy tube with semipermeable membrane.

874.3950 Transcutaneous air conduction hearing aid system.

### Subpart E—Surgical Devices

874.4100 Epistaxis balloon.

874.4140 Ear, nose, and throat bur.

874.4175 Nasopharyngeal catheter.

874.4180 Eustachian tube balloon dilation system.

874.4250 Ear, nose, and throat electric or pneumatic surgical drill.

874.4350 Ear, nose, and throat fiberoptic light source and carrier.

874.4420 Ear, nose, and throat manual surgical instrument.

## § 874.1

## 21 CFR Ch. I (4–1–20 Edition)

- 874.4490 Argon laser for otology, rhinology, and laryngology.
- 874.4500 Ear, nose, and throat microsurgical carbon dioxide laser.
- 874.4680 Bronchoscope (flexible or rigid) and accessories.
- 874.4710 Esophagoscope (flexible or rigid) and accessories.
- 874.4720 Mediastinoscope and accessories.
- 874.4750 Laryngostroboscope.
- 874.4760 Nasopharyngoscope (flexible or rigid) and accessories.
- 874.4770 Otoscope.
- 874.4780 Intranasal splint.
- 874.4800 Bone particle collector.

### Subpart F—Therapeutic Devices

- 874.5220 Ear, nose, and throat drug administration device.
- 874.5300 Ear, nose, and throat examination and treatment unit.
- 874.5350 Suction antichoke device.
- 874.5370 Tongs antichoke device.
- 874.5550 Powered nasal irrigator.
- 874.5800 External nasal splint.
- 874.5840 Antistammering device.
- 874.5900 External upper esophageal sphincter compression device.

AUTHORITY: 21 U.S.C. 351, 360, 360c, 360e, 360j, 360l, 371.

SOURCE: 51 FR 40389, Nov. 6, 1986, unless otherwise noted.

EDITORIAL NOTE: Nomenclature changes to part 874 appear at 73 FR 35341, June 23, 2008.

### Subpart A—General Provisions

#### § 874.1 Scope.

(a) This part sets forth the classification of ear, nose, and throat devices intended for human use that are in commercial distribution.

(b) The identification of a device in a regulation in this part is not a precise description of every device that is, or will be, subject to the regulation. A manufacturer who submits a premarket notification submission for a device under part 807 cannot show merely that the device is accurately described by the section title and identification provision of a regulation in this part, but shall state why the device is substantially equivalent to other devices, as required by § 807.87.

(c) To avoid duplicative listings, an ear, nose, and throat device that has two or more types of uses (e.g., used both as a diagnostic device and as a therapeutic device) is listed in one subpart only.

(d) References in this part to regulatory sections of the Code of Federal Regulations are to chapter I of title 21 unless otherwise noted.

(e) Guidance documents referenced in this part are available on the Internet at <http://www.fda.gov/MedicalDevices/DeviceRegulationandGuidance/GuidanceDocuments/default.htm>.

[51 FR 40389, Nov. 6, 1986, as amended at 67 FR 67790, Nov. 7, 2002; 78 FR 18233, Mar. 26, 2013]

#### § 874.3 Effective dates of requirement for premarket approval.

A device included in this part that is classified into class III (premarket approval) shall not be commercially distributed after the date shown in the regulation classifying the device unless the manufacturer has an approval under section 515 of the act (unless an exemption has been granted under section 520(g)(2) of the act). An approval under section 515 of the act consists of FDA's issuance of an order approving an application for premarket approval (PMA) for the device or declaring completed a product development protocol (PDP) for the device.

(a) Before FDA requires that a device commercially distributed before the enactment date of the amendments, or a device that has been found substantially equivalent to such a device, has an approval under section 515 of the act FDA must promulgate a regulation under section 515(b) of the act requiring such approval, except as provided in paragraph (b) of this section. Such a regulation under section 515(b) of the act shall not be effective during the grace period ending on the 90th day after its promulgation or on the last day of the 30th full calendar month after the regulation that classifies the device into class III is effective, whichever is later. See section 501(f)(2)(B) of the act. Accordingly, unless an effective date of the requirement for premarket approval is shown in the regulation for a device classified into class III in this part, the device may be commercially distributed without FDA's issuance of an order approving a PMA declaring completed a PDP for the device. If FDA promulgates a regulation under section 515(b) of the act requiring premarket approval for a device,

section 501(f)(1)(A) of the act applies to the device.

(b) Any new, not substantially equivalent, device introduced into commercial distribution on or after May 28, 1976, including a device formerly marketed that has been substantially altered, is classified by statute (section 513(f) of the act) into class III without any grace period and FDA must have issued an order approving a PMA or declaring completed a PDP for the device before the device is commercially distributed unless it is reclassified. If FDA knows that a device being commercially distributed may be a “new” device as defined in this section because of any new intended use or other reasons, FDA may codify the statutory classification of the device into class III for such new use. Accordingly, the regulation for such a class III device states that as of the enactment date of the amendments, May 28, 1976, the device must have an approval under section 515 of the act before commercial distribution.

**§ 874.9 Limitations of exemptions from section 510(k) of the Federal Food, Drug, and Cosmetic Act (the act).**

The exemption from the requirement of premarket notification (section 510(k) of the act) for a generic type of class I or II device is only to the extent that the device has existing or reasonably foreseeable characteristics of commercially distributed devices within that generic type or, in the case of in vitro diagnostic devices, only to the extent that misdiagnosis as a result of using the device would not be associated with high morbidity or mortality. Accordingly, manufacturers of any commercially distributed class I or II device for which FDA has granted an exemption from the requirement of premarket notification must still submit a premarket notification to FDA before introducing or delivering for introduction into interstate commerce for commercial distribution the device when:

(a) The device is intended for a use different from the intended use of a legally marketed device in that generic type of device; e.g., the device is intended for a different medical purpose, or the device is intended for lay use

where the former intended use was by health care professionals only;

(b) The modified device operates using a different fundamental scientific technology than a legally marketed device in that generic type of device; e.g., a surgical instrument cuts tissue with a laser beam rather than with a sharpened metal blade, or an in vitro diagnostic device detects or identifies infectious agents by using deoxyribonucleic acid (DNA) probe or nucleic acid hybridization technology rather than culture or immunoassay technology; or

(c) The device is an in vitro device that is intended:

(1) For use in the diagnosis, monitoring, or screening of neoplastic diseases with the exception of immunohistochemical devices;

(2) For use in screening or diagnosis of familial or acquired genetic disorders, including inborn errors of metabolism;

(3) For measuring an analyte that serves as a surrogate marker for screening, diagnosis, or monitoring life-threatening diseases such as acquired immune deficiency syndrome (AIDS), chronic or active hepatitis, tuberculosis, or myocardial infarction or to monitor therapy;

(4) For assessing the risk of cardiovascular diseases;

(5) For use in diabetes management;

(6) For identifying or inferring the identity of a microorganism directly from clinical material;

(7) For detection of antibodies to microorganisms other than immunoglobulin G (IgG) or IgG assays when the results are not qualitative, or are used to determine immunity, or the assay is intended for use in matrices other than serum or plasma;

(8) For noninvasive testing as defined in § 812.3(k) of this chapter; and

(9) For near patient testing (point of care).

[65 FR 2315, Jan. 14, 2000]

**Subpart B—Diagnostic Devices**

**§ 874.1050 Audiometer.**

(a) *Identification.* An audiometer or automated audiometer is an electroacoustic device that produces

## § 874.1060

## 21 CFR Ch. I (4–1–20 Edition)

controlled levels of test tones and signals intended for use in conducting diagnostic hearing evaluations and assisting in the diagnosis of possible otologic disorders.

(b) *Classification*. Class II. Except for the otoacoustic emission device, the device is exempt from the premarket notification procedures in subpart E of part 807 of this chapter, if it is in compliance with American National Standard Institute S3.6–1996, “Specification for Audiometers,” and subject to the limitations in § 874.9.

[51 FR 40389, Nov. 6, 1986, as amended at 64 FR 14831, Mar. 29, 1999]

### § 874.1060 Acoustic chamber for audiometric testing.

(a) *Identification*. An acoustic chamber for audiometric testing is a room that is intended for use in conducting diagnostic hearing evaluations and that eliminates sound reflections and provides isolation from outside sounds.

(b) *Classification*. Class I (general controls). The device is exempt from the premarket notification procedures in subpart E of part 807 of this chapter subject to the limitations in § 874.9.

[51 FR 40389, Nov. 6, 1986, as amended at 61 FR 1121, Jan. 16, 1996; 66 FR 38800, July 25, 2001]

### § 874.1070 Short increment sensitivity index (SISI) adapter.

(a) *Identification*. A short increment sensitivity index (SISI) adapter is a device used with an audiometer in diagnostic hearing evaluations. A SISI adapter provides short periodic sound pulses in specific small decibel increments that are intended to be superimposed on the audiometer’s output tone frequency.

(b) *Classification*. Class I (general controls). The device is exempt from the premarket notification procedures in subpart E of part 807 of this chapter subject to § 874.9.

[55 FR 48440, Nov. 20, 1990, as amended at 65 FR 2315, Jan. 14, 2000]

### § 874.1080 Audiometer calibration set.

(a) *Identification*. An audiometer calibration set is an electronic reference device that is intended to calibrate an audiometer. It measures the sound fre-

quency and intensity characteristics that emanate from an audiometer earphone. The device consists of an acoustic cavity of known volume, a sound level meter, a microphone with calibration traceable to the National Bureau of Standards, oscillators, frequency counters, microphone amplifiers, and a recorder. The device can measure selected audiometer test frequencies at a given intensity level, and selectable audiometer attenuation settings at a given test frequency.

(b) *Classification*. Class I (general controls). The device is exempt from the premarket notification procedures in subpart E of part 807 of this chapter subject to the limitations in § 874.9.

[51 FR 40389, Nov. 6, 1986, as amended at 61 FR 1121, Jan. 16, 1996; 66 FR 38800, July 25, 2001]

### § 874.1090 Auditory impedance tester.

(a) *Identification*. An auditory impedance tester is a device that is intended to change the air pressure in the external auditory canal and measure and graph the mobility characteristics of the tympanic membrane to evaluate the functional condition of the middle ear. The device is used to determine abnormalities in the mobility of the tympanic membrane due to stiffness, flaccidity, or the presence of fluid in the middle ear cavity. The device is also used to measure the acoustic reflex threshold from contractions of the stapedial muscle, to monitor healing of tympanic membrane grafts or stapedectomies, or to monitor followup treatment for inflammation of the middle ear.

(b) *Classification*. Class II (special controls). The device, when it is a tympanometer or auditory impedance tester that complies with FDA-recognized consensus standard ANSI S3.39, is exempt from the premarket notification procedures in subpart E of part 807 of this chapter subject to the limitations in § 874.9.

[51 FR 40389, Nov. 6, 1986, as amended at 84 FR 71813, Dec. 30, 2019]

### § 874.1100 Earphone cushion for audiometric testing.

(a) *Identification*. An earphone cushion for audiometric testing is a device that is used to cover an audiometer

earphone during audiometric testing to provide an acoustic coupling (sound connection path) between the audiometer earphone and the patient's ear.

(b) *Classification.* Class I (general controls). The device is exempt from the premarket notification procedures in subpart E of part 807 of this chapter subject to § 874.9.

[51 FR 40389, Nov. 9, 1986; 52 FR 18495, May 15, 1987, as amended at 52 FR 32111, Aug. 25, 1987; 65 FR 2315, Jan. 14, 2000]

**§ 874.1120 Electronic noise generator for audiometric testing.**

(a) *Identification.* An electronic noise generator for audiometric testing is a device that consists of a swept frequency generator, an amplifier, and an earphone. It is intended to introduce a masking noise into the non-test ear during an audiometric evaluation. The device minimizes the non-test ear's sensing of test tones and signals being generated for the ear being tested.

(b) *Classification.* Class II (special controls). The device is exempt from the premarket notification procedures in subpart E of part 807 of this chapter subject to the limitations in § 874.9.

[51 FR 40389, Nov. 6, 1986, as amended at 84 FR 71813, Dec. 30, 2019]

**§ 874.1325 Electroglottograph.**

(a) *Identification.* An electroglottograph is an AC-powered device that employs a pair of electrodes that are placed in contact with the skin on both sides of the larynx and held in place by a collar. It is intended to measure the electrical impedance of the larynx to aid in assessing the degree of closure of the vocal cords, confirm laryngeal diagnosis, aid behavioral treatment of voice disorders, and aid research concerning the laryngeal mechanism.

(b) *Classification.* Class II (special controls). The device is exempt from the premarket notification procedures in subpart E of part 807 of this chapter subject to the limitations in § 874.9.

[51 FR 40389, Nov. 6, 1986, as amended at 84 FR 71813, Dec. 30, 2019]

**§ 874.1500 Gustometer.**

(a) *Identification.* A gustometer is a battery-powered device that consists of

two electrodes that are intended to be placed on both sides of the tongue at different taste centers and that provides a galvanic stimulus resulting in taste sensation. It is used for assessing the sense of taste.

(b) *Classification.* Class I (general controls). The device is exempt from the premarket notification procedures in subpart E of part 807 of this chapter subject to § 874.9. If the device is not labeled or otherwise represented as sterile, it is exempt from the current good manufacturing practice requirements of the quality system regulation in part 820 of this chapter, with the exception of § 820.180 of this chapter, with respect to general requirements concerning records, and § 820.198 of this chapter, with respect to complaint files.

[51 FR 40389, Nov. 6, 1986, as amended at 65 FR 2316, Jan. 14, 2000]

**§ 874.1600 Olfactory test device.**

(a) *Identification.* An olfactory test device is used to determine whether an olfactory loss is present. The device includes one or more odorants that are presented to the patient's nose to subjectively assess the patient's ability to perceive odors.

(b) *Classification.* Class II (special controls). The special control for these devices is the FDA guidance document entitled "Class II Special Controls Guidance Document: Olfactory Test Device." For the availability of this guidance document, see § 874.1(e). The device is exempt from the premarket notification procedures in subpart E of part 807 of this chapter subject to the limitations in § 874.9. When indicated for the screening or diagnosis of diseases or conditions other than the loss of olfactory function, the device is not exempt from premarket notification procedures.

[71 FR 32835, June 7, 2006]

**§ 874.1800 Air or water caloric stimulator.**

(a) *Identification.* An air or water caloric stimulator is a device that delivers a stream of air or water to the ear canal at controlled rates of flow and temperature and that is intended for

## § 874.1820

vestibular function testing of a patient's body balance system. The vestibular stimulation of the semicircular canals produce involuntary eye movements that are measured and recorded by a nystagmograph.

(b) *Classification.* Class I (general controls). The device is exempt from the premarket notification procedures in subpart E of part 807 of this chapter subject to § 874.9.

[55 FR 48440, Nov. 20, 1990, as amended at 65 FR 2316, Jan. 14, 2000]

## § 874.1820 Surgical nerve stimulator/locator.

(a) *Identification.* A surgical nerve stimulator/locator is a device that is intended to provide electrical stimulation to the body to locate and identify nerves and to test their excitability.

(b) *Classification.* Class II.

## § 874.1925 Toynbee diagnostic tube.

(a) *Identification.* The toynbee diagnostic tube is a listening device intended to determine the degree of openness of the eustachian tube.

(b) *Classification.* Class I (general controls). The device is exempt from the premarket notification procedures in subpart E of part 807 of this chapter subject to § 874.9.

[51 FR 40389, Nov. 6, 1986, as amended at 65 FR 2316, Jan. 14, 2000]

## Subpart C [Reserved]

## Subpart D—Prosthetic Devices

### § 874.3300 Hearing Aid.

(a) *Identification.* A hearing aid is wearable sound-amplifying device that is intended to compensate for impaired hearing. This generic type of device includes the air-conduction hearing aid and the bone-conduction hearing aid, but excludes the group hearing aid or group auditory trainer (§ 874.3320), master hearing aid (§ 874.3330), and tinnitus masker (§ 874.3400).

(b) *Classification.* (1) Class I (general controls) for the air-conduction hearing aid. The air-conduction hearing aid is exempt from the premarket notification procedures in subpart E of part 807 of this chapter subject to § 874.9.

## 21 CFR Ch. I (4–1–20 Edition)

(2) Class II for the bone-conduction hearing aid.

[51 FR 40389, Nov. 6, 1986, as amended at 65 FR 2316, Jan. 14, 2000]

### § 874.3305 Wireless air-conduction hearing aid.

(a) *Identification.* A wireless air-conduction hearing aid is a wearable sound-amplifying device, intended to compensate for impaired hearing that incorporates wireless technology in its programming or use.

(b) *Classification.* Class II (special controls). The special controls for this device are:

(1) Appropriate analysis/testing should validate electro magnetic compatibility (EMC) and safety of exposure to non-ionizing radiation;

(2) Design, description, and performance data should validate wireless technology functions; and

(3) Labeling should specify appropriate instructions, warnings, and information relating to EMC and wireless technology and human exposure to non-ionizing radiation.

(c) *Premarket notification.* The wireless air-conduction hearing aid is exempt from the premarket notification procedures in subpart E of part 807 of this chapter subject to § 874.9.

[76 FR 34846, June 15, 2011]

### § 874.3310 Hearing aid calibrator and analysis system.

(a) *Identification.* A hearing aid calibrator and analysis system is an electronic reference device intended to calibrate and assess the electroacoustic frequency and sound intensity characteristics emanating from a hearing aid, master hearing aid, group hearing aid or group auditory trainer. The device consists of an acoustic complex of known cavity volume, a sound level meter, a microphone, oscillators, frequency counters, microphone amplifiers, a distortion analyzer, a chart recorder, and a hearing aid test box.

(b) *Classification.* Class II (special controls). The device is exempt from the premarket notification procedures



in subpart E of part 807 of this chapter subject to the limitations in § 874.9.

[51 FR 40389, Nov. 6, 1986, as amended at 84 FR 71813, Dec. 30, 2019]

**§ 874.3315 Tympanic membrane contact hearing aid.**

(a) *Identification.* A tympanic membrane contact hearing aid is a prescription device that compensates for impaired hearing. Amplified sound is transmitted by vibrating the tympanic membrane through a transducer that is in direct contact with the tympanic membrane.

(b) *Classification.* Class II (special controls). The special controls for this device are:

(1) The patient contacting components must be demonstrated to be biocompatible.

(2) Non-clinical performance testing must demonstrate that the device performs as intended under anticipated conditions of use, and must include:

- (i) Mechanical integrity testing;
- (ii) Electrical and thermal safety testing;
- (iii) Software verification, validation, and hazard analysis;
- (iv) Reliability testing consistent with expected device life;
- (v) Electromagnetic compatibility testing; and
- (vi) Validation testing of device output and mechanical force applied to the tympanic membrane in a clinically appropriate model.

(3) Clinical performance testing must characterize any adverse events observed during clinical use, and demonstrate that the device performs as intended under anticipated conditions of use.

(4) Professional training must include the ear impression procedure, correct placement, fitting, monitoring, care, and maintenance of the device.

(5) Labeling must include the following:

- (i) A detailed summary of the adverse events and effectiveness outcomes from the clinical performance testing;
- (ii) Detailed instructions on how to fit the device to the patient;
- (iii) Instructions for periodic cleaning of any reusable components;
- (iv) Information related to electromagnetic compatibility; and

(v) Patient labeling that includes:

(A) A patient card that identifies if a patient has been fitted with any non-self-removable components of the device and provides relevant information in cases of emergency;

(B) Information on how to correctly use and maintain the device;

(C) The potential risks and benefits associated with the use of the device; and

(D) Alternative treatments.

[81 FR 3326, Jan. 21, 2015]

**§ 874.3320 Group hearing aid or group auditory trainer.**

(a) *Identification.* A group hearing aid or group auditory trainer is a hearing aid that is intended for use in communicating simultaneously with one or more listeners having hearing impairment. The device is used with an associated transmitter microphone. It may be either monaural or binaural, and it provides coupling to the ear through either earphones or earmolds. The generic type of device includes three types of applications: hardwire systems, inductance loop systems, and wireless systems.

(b) *Classification.* Class II (special controls). The device is exempt from the premarket notification procedures in subpart E of part 807 of this chapter subject to the limitations in § 874.9.

[51 FR 40389, Nov. 6, 1986, as amended at 84 FR 71813, Dec. 30, 2019]

**§ 874.3325 Self-fitting air-conduction hearing aid.**

(a) *Identification.* A self-fitting air-conduction hearing aid is a wearable sound amplifying device that is intended to compensate for impaired hearing and incorporates technology, including software, that allows users to program their hearing aids. This technology integrates user input with a self-fitting strategy and enables users to independently derive and customize their hearing aid fitting and settings.

(b) *Classification.* Class II (special controls). The special controls for this device are:

- (1) Clinical data must evaluate the effectiveness of the self-fitting strategy.

**§ 874.3330**

(2) Electroacoustic parameters, including maximum output limits, distortion levels, self-generated noise levels, latency, and frequency response, must be specified and tested.

(3) Performance data must demonstrate the electromagnetic compatibility (EMC), electrical safety, and thermal safety of the device.

(4) Software verification, validation, and hazard analysis must be performed.

(5) If the device incorporates wireless technology:

(i) Performance testing must validate safety of exposure to non-ionizing radiation;

(ii) Performance data must validate wireless technology functions; and

(iii) Labeling must specify instructions, warnings, and information relating to wireless technology and human exposure to non-ionizing radiation.

(6) Usability testing must demonstrate that users can correctly use the device as intended under anticipated conditions of use.

(7) Patient labeling must include the following:

(i) Information on how a patient can self-identify as a candidate for the device;

(ii) Information about when to seek professional help;

(iii) A warning about using hearing protection in loud environments;

(iv) A warning about staying alert to sounds around the user of the device;

(v) Technical information about the device, including information about EMC; and

(vi) Information on how to correctly use and maintain the device.

[84 FR 57612, Oct. 28, 2019]

**§ 874.3330 Master hearing aid.**

(a) *Identification.* A master hearing aid is an electronic device intended to simulate a hearing aid during audiometric testing. It has adjustable acoustic output levels, such as those for gain, output, and frequency response. The device is used to select and adjust a person's wearable hearing aid.

(b) *Classification.* Class II (special controls). The device is exempt from the premarket notification procedures

**21 CFR Ch. I (4–1–20 Edition)**

in subpart E of part 807 of this chapter subject to the limitations in § 874.9.

[51 FR 40389, Nov. 6, 1986, as amended at 84 FR 71813, Dec. 30, 2019]

**§ 874.3340 Active implantable bone conduction hearing system.**

(a) *Identification.* An active implantable bone conduction hearing system is a prescription device consisting of an implanted transducer, implanted electronics components, and an audio processor. The active implantable bone conduction hearing system is intended to compensate for conductive or mixed hearing losses by conveying amplified acoustic signals to the cochlea via mechanical vibrations on the skull bone.

(b) *Classification.* Class II (special controls). The special controls for this device are:

(1) Clinical performance testing must characterize any adverse events observed during implantation and clinical use, and must also demonstrate that the device performs as intended under anticipated conditions of use.

(2) Non-clinical performance testing must demonstrate that the device performs as intended under anticipated conditions of use, including the following:

(i) Performance data must validate force output in a clinically relevant model.

(ii) Impact testing in a clinically relevant anatomic model must be performed.

(iii) Mechanical integrity testing must be performed.

(iv) Reliability testing consistent with expected device life must be performed.

(3) The patient-contacting components of the device must be demonstrated to be biocompatible.

(4) Performance data must demonstrate the sterility of the patient-contacting components of the device.

(5) Performance data must support the shelf life of the device by demonstrating continued sterility, package integrity, and device functionality over the identified shelf life.

(6) Performance data must demonstrate the wireless compatibility, electromagnetic compatibility, and electrical safety of the device.

(7) Software verification, validation, and hazard analysis must be performed.

(8) Labeling must include:

(i) A summary of clinical testing conducted with the device that includes a summary of device-related complications and adverse events;

(ii) Instructions for use;

(iii) A surgical guide for implantation, which includes instructions for imaging to assess bone dimensions;

(iv) A shelf life, for device components provided sterile;

(v) A patient identification card; and

(vi) A patient user manual.

[83 FR 54009, Oct. 26, 2018]

**§ 874.3375 Battery-powered artificial larynx.**

(a) *Identification.* A battery-powered artificial larynx is an externally applied device intended for use in the absence of the larynx to produce sound. When held against the skin in the area of the voicebox, the device generates mechanical vibrations which resonate in the oral and nasal cavities and can be modulated by the tongue and lips in a normal manner, thereby allowing the production of speech.

(b) *Classification.* Class I (general controls). The device is exempt from the premarket notification procedures in subpart E of part 807 of this chapter subject to the limitations in § 874.9.

[51 FR 40389, Nov. 6, 1986, as amended at 59 FR 63009, Dec. 7, 1994; 66 FR 38800, July 25, 2001]

**§ 874.3400 Tinnitus masker.**

(a) *Identification.* A tinnitus masker is an electronic device intended to generate noise of sufficient intensity and bandwidth to mask ringing in the ears or internal head noises. Because the device is able to mask internal noises, it is also used as an aid in hearing external noises and speech.

(b) *Classification.* Class II. The special control for this device is patient labeling regarding:

(1) Hearing health care professional diagnosis, fitting of the device, and followup care,

(2) Risks,

(3) Benefits,

(4) Warnings for safe use, and

(5) Specifications.

[51 FR 40389, Nov. 6, 1986, as amended at 65 FR 17145, Mar. 31, 2000]

**§ 874.3430 Middle ear mold.**

(a) *Identification.* A middle ear mold is a preformed device that is intended to be implanted to reconstruct the middle ear cavity during repair of the tympanic membrane. The device permits an ample air-filled cavity to be maintained in the middle ear and promotes regeneration of the mucous membrane lining of the middle ear cavity. A middle ear mold is made of materials such as polyamide, polytetrafluoroethylene, silicone elastomer, or polyethylene, but does not contain porous polyethylene.

(b) *Classification.* Class II (special controls). The device is exempt from the premarket notification procedures in subpart E of part 807 of this chapter subject to the limitations in § 874.9.

[51 FR 40389, Nov. 6, 1986, as amended at 84 FR 71813, Dec. 30, 2019]

**§ 874.3450 Partial ossicular replacement prosthesis.**

(a) *Identification.* A partial ossicular replacement prosthesis is a device intended to be implanted for the functional reconstruction of segments of the ossicular chain and facilitates the conduction of sound wave from the tympanic membrane to the inner ear. The device is made of materials such as stainless steel, tantalum, polytetrafluoroethylene, polyethylene, polytetrafluoroethylene with carbon fibers composite, absorbable gelatin material, porous polyethylene, or from a combination of these materials.

(b) *Classification.* Class II.

**§ 874.3495 Total ossicular replacement prosthesis.**

(a) *Identification.* A total ossicular replacement prosthesis is a device intended to be implanted for the total functional reconstruction of the ossicular chain and facilitates the conduction of sound waves from the tympanic membrane to the inner ear. The device is made of materials such as polytetrafluoroethylene, polytetrafluoroethylene with vitreous carbon fibers

## § 874.3540

composite, porous polyethylene, or from a combination of these materials.

(b) *Classification.* Class II.

### § 874.3540 Prosthesis modification instrument for ossicular replacement surgery.

(a) *Identification.* A prosthesis modification instrument for ossicular replacement surgery is a device intended for use by a surgeon to construct ossicular replacements. This generic type of device includes the ear, nose, and throat cutting block; wire crimper, wire bending die; wire closure forceps; piston cutting jib; gelfoam™ punch; wire cutting scissors; and ossicular finger vise.

(b) *Classification.* Class I (general controls). The device is exempt from the premarket notification procedures in subpart E of part 807 of this chapter subject to § 874.9. If the device is not labeled or otherwise represented as sterile, it is exempt from the current good manufacturing practice requirements of the quality system regulation in part 820 of this chapter, with the exception of § 820.180 of this chapter, with respect to general requirements concerning records, and § 820.198 of this chapter, with respect to complaint files.

[51 FR 40389, Nov. 9, 1986, as amended at 52 FR 32111, Aug. 25, 1987; 65 FR 2316, Jan. 14, 2000]

### § 874.3620 Ear, nose, and throat synthetic polymer material.

(a) *Identification.* Ear, nose, and throat synthetic polymer material is a device material that is intended to be implanted for use as a space-occupying substance in the reconstructive surgery of the head and neck. The device is used, for example, in augmentation rhinoplasty and in tissue defect closures in the esophagus. The device is shaped and formed by the surgeon to conform to the patient's needs. This generic type of device is made of material such as polyamide mesh or foil and porous polyethylene.

(b) *Classification.* Class II.

### § 874.3695 Mandibular implant facial prosthesis.

(a) *Identification.* A mandibular implant facial prosthesis is a device that

## 21 CFR Ch. I (4–1–20 Edition)

is intended to be implanted for use in the functional reconstruction of mandibular deficits. The device is made of materials such as stainless steel, tantalum, titanium, cobalt-chromium based alloy, polytetrafluoroethylene, silicone elastomer, polyethylene, polyurethane, or polytetrafluoroethylene with carbon fibers composite.

(b) *Classification.* Class II.

### § 874.3730 Laryngeal prosthesis (Taub design).

(a) *Identification.* A laryngeal prosthesis (Taub design) is a device intended to direct pulmonary air flow to the pharynx in the absence of the larynx, thereby permitting esophageal speech. The device is interposed between openings in the trachea and the esophagus and may be removed and replaced each day by the patient. During phonation, air from the lungs is directed to flow through the device and over the esophageal mucosa to provide a sound source that is articulated as speech.

(b) *Classification.* Class II (special controls). The device, when it is a voice amplification device, is exempt from the premarket notification procedures in subpart E of part 807 of this chapter subject to the limitations in § 874.9.

[51 FR 40389, Nov. 6, 1986, as amended at 84 FR 71813, Dec. 30, 2019]

### § 874.3760 Sacculotomy tack (Cody tack)

(a) *Identification.* A sacculotomy tack (Cody tack) is a device that consists of a pointed stainless steel tack intended to be implanted to relieve the symptoms of vertigo. The device repetitively ruptures the utricular membrane as the membrane expands under increased endolymphatic pressure.

(b) *Classification.* Class II.

### § 874.3820 Endolymphatic shunt.

(a) *Identification.* An endolymphatic shunt is a device that consists of a tube or sheet intended to be implanted to relieve the symptoms of vertigo. The device permits the unrestricted flow of excess endolymph from the distended end of the endolymphatic system into the mastoid cavity where resorption

occurs. This device is made of polytetrafluoroethylene or silicone elastomer.

(b) *Classification*. Class II.

**§ 874.3850 Endolymphatic shunt tube with valve.**

(a) *Identification*. An endolymphatic shunt tube with valve is a device that consists of a pressure-limiting valve associated with a tube intended to be implanted in the inner ear to relieve symptoms of vertigo and hearing loss due to endolymphatic hydrops (increase in endolymphatic fluid) of Meniere's disease.

(b) *Classification*. Class II (special controls). The special control for this device is the FDA guidance document "Class II Special Controls Guidance Document: Endolymphatic Shunt Tube With Valve; Guidance for Industry and FDA."

[67 FR 20894, Apr. 29, 2002]

**§ 874.3880 Tympanostomy tube.**

(a) *Identification*. A tympanostomy tube is a device that is intended to be implanted for ventilation or drainage of the middle ear. The device is inserted through the tympanic membrane to permit a free exchange of air between the outer ear and middle ear. A type of tympanostomy tube known as the malleous clip tube attaches to the malleous to provide middle ear ventilation. The device is made of materials such as polytetrafluoroethylene, polyethylene, silicon elastomer, or porous polyethylene.

(b) *Classification*. Class II.

**§ 874.3900 Nasal dilator.**

(a) *Identification*. A nasal dilator is a device intended to provide temporary relief from transient causes of breathing difficulties resulting from structural abnormalities and/or transient causes of nasal congestion associated with reduced nasal airflow. The device decreases airway resistance and increases nasal airflow. The external nasal dilator is constructed from one or more layers of material upon which a spring material is attached, with a skin adhesive applied to adhere to the skin of the nose; it acts with a pulling action to open the nares. The internal nasal dilator is constructed from metal

or plastic and is placed inside the nostrils; it acts by pushing the nostrils open or by gently pressing on the columella.

(b) *Classification*. Class I (general controls). The device is exempt from the premarket notification procedures in subpart E of part 807 of this chapter subject to the limitations in § 874.9.

[64 FR 10949, Mar. 8, 1999]

**§ 874.3930 Tympanostomy tube with semipermeable membrane.**

(a) *Identification*. A tympanostomy tube with a semipermeable membrane is a device intended to be implanted for ventilation or drainage of the middle ear and for preventing fluids from entering the middle ear cavity. The device is inserted through the tympanic membrane to permit a free exchange of air between the outer ear and middle ear. The tube portion of the device is made of silicone elastomer or porous polyethylene, and the membrane portion is made of polytetrafluoroethylene.

(b) *Classification*. Class II. The special control for this device is FDA's "Tympanostomy Tubes, Submission Guidance for a 510(k)."

[51 FR 40389, Nov. 6, 1986, as amended at 65 FR 17145, Mar. 31, 2000]

**§ 874.3950 Transcutaneous air conduction hearing aid system.**

(a) *Identification*. A transcutaneous air conduction hearing aid system is a wearable sound-amplifying device intended to compensate for impaired hearing without occluding the ear canal. The device consists of an air conduction hearing aid attached to a surgically fitted tube system, which is placed through soft tissue between the post auricular region and the outer ear canal.

(b) *Classification*. Class II (special controls). The special control for this device is FDA's guidance document entitled "Class II Special Controls Guidance Document: Transcutaneous Air Conduction Hearing Aid System (TACHAS); Guidance for Industry and FDA." See § 874.1 for the availability of this guidance document.

[67 FR 67790, Nov. 7, 2002]

**Subpart E—Surgical Devices****§ 874.4100 Epistaxis balloon.**

(a) *Identification.* An epistaxis balloon is a device consisting of an inflatable balloon intended to control internal nasal bleeding by exerting pressure against the sphenopalatine artery.

(b) *Classification* Class I (general controls). The device is exempt from the premarket notification procedures in subpart E of part 807 of this chapter subject to § 874.9.

[51 FR 40389, Nov. 6, 1986, as amended at 65 FR 2316, Jan. 14, 2000]

**§ 874.4140 Ear, nose, and throat bur.**

(a) *Identification.* An ear, nose, and throat bur is a device consisting of an interchangeable drill bit that is intended for use in an ear, nose, and throat electric or pneumatic surgical drill (§ 874.4250) for incising or removing bone in the ear, nose, or throat area. The bur consists of a carbide cutting tip on a metal shank or a coating of diamond on a metal shank. The device is used in mastoid surgery, frontal sinus surgery, and surgery of the facial nerves.

(b) *Classification.* Class I (general controls). The device is exempt from the premarket notification procedures in subpart E of part 807 of this chapter subject to the limitations in § 874.9.

[51 FR 40389, Nov. 6, 1986, as amended at 61 FR 1122, Jan. 16, 1996; 66 FR 38800, July 25, 2001]

**§ 874.4175 Nasopharyngeal catheter.**

(a) *Identification.* A nasopharyngeal catheter is a device consisting of a bougie or filiform catheter that is intended for use in probing or dilating the eustachian tube. This generic type of device includes eustachian catheters.

(b) *Classification.* Class I (general controls). The device is exempt from the premarket notification procedures in subpart E of part 807 of this chapter subject to the limitations in § 874.9.

[51 FR 40389, Nov. 6, 1986, as amended at 61 FR 1122, Jan. 16, 1996; 66 FR 38801, July 25, 2001]

**§ 874.4180 Eustachian tube balloon dilation system.**

(a) *Identification.* A Eustachian tube balloon dilation system is a prescription device that includes a flexible catheter attached to an inflatable balloon. The system is intended for use in dilating the cartilaginous portion of the Eustachian tube for treating persistent Eustachian tube dysfunction.

(b) *Classification.* Class II (special controls). The special controls for this device are:

(1) Non-clinical performance testing must demonstrate that the device performs as intended under anticipated conditions of use. The following performance characteristics must be evaluated:

(i) Mechanical testing, including tensile and flexural testing of catheter joints and materials.

(ii) Durability testing, including fatigue and burst pressure testing of the balloon materials and components.

(iii) Inflation and deflation characterization testing, including time and pressure measurements, and leak testing of the balloon.

(iv) Verification testing of safety features built into the device must be performed, including the characterization of catheter geometries and distal tip insertion limitation mechanisms.

(2) Simulated use testing in a clinically relevant model must demonstrate the reliability of the device to remain mechanically functional throughout the anticipated conditions of use, and validate that the design features limit access to only the cartilaginous portion of the Eustachian tube.

(3) The patient-contacting components of the device must be demonstrated to be biocompatible.

(4) Performance data must demonstrate the sterility of the device.

(5) Performance data must support shelf life by demonstrating continued sterility of the device, package integrity, and device functionality over the identified shelf life.

(6) Training must include simulated use on cadavers to ensure users can follow the instructions for use to allow safe use of the device.

(7) Labeling must include:

(i) Detailed instructions for use.

(ii) A detailed summary of the device technical parameters, including maximum allowed inflation pressure, allowable catheter geometries, and available balloon sizes.

(iii) A shelf life.

[81 FR 73041, Oct. 24, 2016]

**§ 874.4250 Ear, nose, and throat electric or pneumatic surgical drill.**

(a) *Identification.* An ear, nose, and throat electric or pneumatic surgical drill is a rotating drilling device, including the handpiece, that is intended to drive various accessories, such as an ear, nose, and throat bur (§ 874.4140), for the controlled incision or removal of bone in the ear, nose, and throat area.

(b) *Classification.* Class II.

**§ 874.4350 Ear, nose, and throat fiberoptic light source and carrier.**

(a) *Identification.* An ear, nose, and throat fiberoptic light source and carrier is an AC-powered device that generates and transmits light through glass of plastic fibers and that is intended to provide illumination at the tip of an ear, nose, or throat endoscope. Endoscopic devices which utilize fiberoptic light sources and carriers include the bronchoscope, esophagoscope, laryngoscope, mediastinoscope, laryngeal-bronchial telescope, and nasopharyngoscope.

(b) *Classification.* Class I (general controls). The device is exempt from the premarket notification procedures in subpart E of part 807 of this chapter subject to the limitations in § 874.9.

[51 FR 40389, Nov. 6, 1986, as amended at 61 FR 1122, Jan. 16, 1996; 66 FR 38801, July 25, 2001]

**§ 874.4420 Ear, nose, and throat manual surgical instrument.**

(a) *Identification.* An ear, nose, and throat manual surgical instrument is one of a variety of devices intended for use in surgical procedures to examine or treat the bronchus, esophagus, trachea, larynx, pharynx, nasal and paranasal sinus, or ear. This generic type of device includes the esophageal dilator; tracheal bistour (a long, narrow surgical knife); tracheal dilator; tracheal hook; laryngeal injection set; laryngeal knife; laryngeal saw; laryngeal trocar; laryngectomy tube; adenoid curette;

adenotome; metal tongue depressor; mouth gag; oral screw; salpingeal curette; tonsillectome; tonsil guillotine; tonsil screw; tonsil snare; tonsil suction tube; tonsil suturing hook; antom retractor; ethmoid curette; frontal sinus-rasp; nasal curette; nasal rasp; nasal rongeur; nasal saw; nasal scissors; nasal snare; sinus irrigator; sinus trephine; ear curette; ear excavator; ear rasp; ear scissor, ear snare; ear spoon; ear suction tube; malleous ripper; mastoid gauge; microsurgical ear chisel; myringotomy tube inserter; ossicle holding clamp; sacculotomy tack inserter; vein press; wire ear loop; microrule; mirror; mobilizer; ear, nose, and throat punch; ear, nose and throat knife; and ear, nose, and throat trocar.

(b) *Classification.* Class I (general controls). The device is exempt from the premarket notification procedures in subpart E of part 807 of this chapter subject to § 874.9.

[51 FR 40389, Nov. 9, 1986, as amended at 52 FR 32111, Aug. 25, 1987; 65 FR 2316, Jan. 14, 2000; 72 FR 17400, Apr. 9, 2007]

**§ 874.4490 Argon laser for otology, rhinology, and laryngology.**

(a) *Identification.* The argon laser device for use in otology, rhinology, and laryngology is an electro-optical device which produces coherent, electromagnetic radiation with principal wavelength peaks of 488 and 514 nanometers. In otology, the device is used for the purpose of coagulating and vaporizing soft and fibrous tissues, including osseous tissue. In rhinology and laryngology, the device is used to coagulate and vaporize soft and fibrous tissues, but not including osseous tissues.

(b) *Classification.* Class II.

[58 FR 29534, May 21, 1993]

**§ 874.4500 Ear, nose, and throat microsurgical carbon dioxide laser.**

(a) *Identification.* An ear, nose, and throat microsurgical carbon dioxide laser is a device intended for the surgical excision of tissue from the ear, nose, and throat area. The device is used, for example, in microsurgical procedures to excise lesions and tumors of the vocal cords and adjacent areas.

(b) *Classification.* Class II.

**§ 874.4680**

**21 CFR Ch. I (4–1–20 Edition)**

**§ 874.4680 Bronchoscope (flexible or rigid) and accessories.**

(a) *Identification.* A bronchoscope (flexible or rigid) and accessories is a tubular endoscopic device with any of a group of accessory devices which attach to the bronchoscope and is intended to examine or treat the larynx and tracheobronchial tree. It is typically used with a fiberoptic light source and carrier to provide illumination. The device is made of materials such as stainless steel or flexible plastic. This generic type of device includes the rigid ventilating bronchoscope, rigid nonventilating bronchoscope, nonrigid bronchoscope, laryngeal-bronchial telescope, flexible foreign body claw, bronchoscope tubing, flexible biopsy forceps, rigid biopsy curette, flexible biopsy brush, rigid biopsy forceps, flexible biopsy curette, and rigid bronchoscope aspirating tube, but excludes the fiberoptic light source and carrier.

(b) *Classification.* Class II.

**§ 874.4710 Esophagoscope (flexible or rigid) and accessories.**

(a) *Identification.* An esophagoscope (flexible or rigid) and accessories is a tubular endoscopic device with any of a group of accessory devices which attach to the esophagoscope and is intended to examine or treat esophageal malfunction symptoms, esophageal or mediastinal disease, or to remove foreign bodies from the esophagus. When inserted, the device extends from the area of the hypopharynx to the stomach. It is typically used with a fiberoptic light source and carrier to provide illumination. The device is made of materials such as stainless steel or flexible plastic. This generic type of device includes the flexible foreign body claw, flexible biopsy forceps, rigid biopsy curette, flexible biopsy brush, rigid biopsy forceps and flexible biopsy curette, but excludes the fiberoptic light source and carrier.

(b) *Classification.* Class II.

**§ 874.4720 Mediastinoscope and accessories.**

(a) *Identification.* A mediastinoscope and accessories is a tubular tapered electrical endoscopic device with any of a group of accessory devices which

attach to the mediastinoscope and is intended to examine or treat tissue in the area separating the lungs. The device is inserted transthoracically and is used in diagnosis of tumors and lesions and to determine whether excision of certain organs or tissues is indicated. It is typically used with a fiberoptic light source and carrier to provide illumination. The device is made of materials such as stainless steel. This generic type of device includes the flexible foreign body claw, flexible biopsy forceps, rigid biopsy curette, flexible biopsy brush, rigid biopsy forceps, and flexible biopsy curette, but excludes the fiberoptic light source and carrier.

(b) *Classification.* Class II.

**§ 874.4750 Laryngostroboscope.**

(a) *Identification.* A laryngostroboscope is a device that is intended to allow observation of glottic action during phonation. The device operates by focusing a stroboscopic light through a lens for direct or mirror reflected viewing of glottic action. The light and microphone that amplifies acoustic signals from the glottic area may or may not contact the patient.

(b) *Classification.* Class I (general controls). The device is exempt from the premarket notification procedures in subpart E of part 807 of this chapter subject to the limitations in § 874.9.

[55 FR 48440, Nov. 20, 1990, as amended at 59 FR 63009, Dec. 7, 1994; 66 FR 38801, July 25, 2001]

**§ 874.4760 Nasopharyngoscope (flexible or rigid) and accessories.**

(a) *Identification.* A nasopharyngoscope (flexible or rigid) and accessories is a tubular endoscopic device with any of a group of accessory devices which attach to the nasopharyngoscope and is intended to examine or treat the nasal cavity and nasal pharynx. It is typically used with a fiberoptic light source and carrier to provide illumination. The device is made of materials such as stainless steel and flexible plastic. This generic type of device includes the antroscope, nasopharyngolaryngoscope, nasosinuscope, nasoscope, postrhinoscope, rhinoscope, salpingoscope, flexible foreign body



claw, flexible biopsy forceps, rigid biopsy curette, flexible biopsy brush, rigid biopsy forceps and flexible biopsy curette, but excludes the fiberoptic light source and carrier.

(b) *Classification*. Class II.

#### § 874.4770 Otoscope.

(a) *Identification*. An otoscope is a device intended to allow inspection of the external ear canal and tympanic membrane under magnification. The device provides illumination of the ear canal for observation by using an AC- or battery-powered light source and an optical magnifying system.

(b) *Classification*. Class I (general controls). The device is exempt from the premarket notification procedures in subpart E of part 807 of this chapter subject to the limitations in § 874.9 only when used in the external ear canal.

[55 FR 48440, Nov. 20, 1990, as amended at 61 FR 1122, Jan. 16, 1996; 66 FR 38801, July 25, 2001]

#### § 874.4780 Intranasal splint.

(a) *Identification*. An intranasal splint is intended to minimize bleeding and edema and to prevent adhesions between the septum and the nasal cavity. It is placed in the nasal cavity after surgery or trauma. The intranasal splint is constructed from plastic, silicone, or absorbent material.

(b) *Classification*. Class I (general controls). The device is exempt from the premarket notification procedures in subpart E of part 807 of this chapter subject to the limitations in § 874.9.

[64 FR 10949, Mar. 8, 1999]

#### § 874.4800 Bone particle collector.

(a) *Identification*. A bone particle collector is a filtering device intended to be inserted into a suction tube during the early stages of otologic surgery to collect bone particles for future use.

(b) *Classification*. Class I (general controls). The device is exempt from premarket notification procedures in subpart E of part 807 of this chapter subject to the limitations in § 874.9.

[64 FR 10949, Mar. 8, 1999]

### Subpart F—Therapeutic Devices

#### § 874.5220 Ear, nose, and throat drug administration device.

(a) *Identification*. An ear, nose, and throat drug administration device is one of a group of ear, nose, and throat devices intended specifically to administer medicinal substances to treat ear, nose, and throat disorders. These instruments include the powder blower, dropper, ear wick, manual nebulizer pump, and nasal inhaler.

(b) *Classification*. Class I (general controls). The device is exempt from the premarket notification procedures in subpart E of part 807 of this chapter subject to the limitations in § 874.9. If the device is not labeled or otherwise represented as sterile, it is exempt from the current good manufacturing practice requirements of the quality system regulation in part 820 of this chapter, with the exception of § 820.180, with respect to general requirements concerning records, and § 820.198, with respect to complaint files.

[51 FR 40389, Nov. 6, 1986, as amended at 59 FR 63009, Dec. 7, 1994; 66 FR 38801, July 25, 2001]

#### § 874.5300 Ear, nose, and throat examination and treatment unit.

(a) *Identification*. An ear, nose, and throat examination and treatment unit is an AC-powered device intended to support a patient during an otologic examination while providing specialized features for examination and treatment. The unit consists of a patient chair and table, drawers for equipment, suction and blowing apparatus, and receptacles for connection of specialized lights and examining instruments.

(b) *Classification*. Class I (general controls). The device is exempt from the premarket notification procedures in subpart E of part 807 of this chapter subject to § 874.9.

[55 FR 48440, Nov. 20, 1990, as amended at 65 FR 2316, Jan. 14, 2000]

#### § 874.5350 Suction antichoke device.

(a) *Identification*. A suction antichoke device is a device intended to be used in an emergency situation to remove, by the application of suction, foreign

## § 874.5370

objects that obstruct a patient's airway to prevent asphyxiation to the patient.

(b) *Classification.* Class III.

(c) *Date PMA or notice of completion of PDP is required.* A PMA or a notice of completion of a PDP for a device is required to be filed with the Food and Drug Administration on or before July 13, 1999 for any suction antichoke device that was in commercial distribution before May 28, 1976, or that has, on or before July 13, 1999, been found to be substantially equivalent to a suction antichoke device that was in commercial distribution before May 28, 1976. Any other suction antichoke device shall have an approved PMA or declared completed PDP in effect before being placed in commercial distribution.

[51 FR 40389, Nov. 6, 1986, as amended at 64 FR 18329, Apr. 14, 1999; 65 FR 2316, Jan. 14, 2000]

## § 874.5370 Tongs antichoke device.

(a) *Identification.* A tongs antichoke device is a device that is intended to be used in an emergency situation to grasp and remove foreign objects that obstruct a patient's airway to prevent asphyxiation of the patient. This generic type of device includes a plastic instrument with serrated ends that is inserted into the airway in a blind manner to grasp and extract foreign objects, and a stainless steel forceps with spoon ends that is inserted under tactile guidance to grasp and extract foreign objects from the airway.

(b) *Classification.* Class III.

(c) *Date PMA or notice of completion of PDP is required.* A PMA or a notice of completion of a PDP for a device is required to be filed with the Food and Drug Administration on or before July 13, 1999 for any tongs antichoke device that was in commercial distribution before May 28, 1976, or that has, on or before July 13, 1999, been found to be substantially equivalent to a tongs antichoke device that was in commercial distribution before May 28, 1976. Any other tongs antichoke device shall have an approved PMA or declared completed PDP in effect before being placed in commercial distribution.

[51 FR 40389, Nov. 6, 1986, as amended at 64 FR 18329, Apr. 14, 1999]

## 21 CFR Ch. I (4-1-20 Edition)

### § 874.5550 Powered nasal irrigator.

(a) *Identification.* A powered nasal irrigator is an AC-powered device intended to wash the nasal cavity by means of a pressure-controlled pulsating stream of water. The device consists of a control unit and pump connected to a spray tube and nozzle.

(b) *Classification.* Class I (general controls). The device is exempt from the premarket notification procedures in subpart E of part 807 of this chapter subject to § 874.9.

[55 FR 48440, Nov. 20, 1990, as amended at 65 FR 2316, Jan. 14, 2000]

### § 874.5800 External nasal splint.

(a) *Identification.* An external nasal splint is a rigid or partially rigid device intended for use externally for immobilization of parts of the nose.

(b) *Classification.* Class I (general controls). The device is exempt from the premarket notification procedures in subpart E of part 807 of this chapter subject to the limitations in § 874.9.

[51 FR 40389, Nov. 9, 1986, as amended at 52 FR 32111, Aug. 25, 1987; 59 FR 63009, Dec. 7, 1994; 66 FR 38801, July 25, 2001]

### § 874.5840 Antistammering device.

(a) *Identification.* An antistammering device is a device that electronically generates a noise when activated or when it senses the user's speech and that is intended to prevent the user from hearing the sounds of his or her own voice. The device is used to minimize a user's involuntary hesitant or repetitive speech.

(b) *Classification.* Class I (general controls). The device is exempt from the premarket notification procedures in subpart E of part 807 of this chapter subject to § 874.9.

[51 FR 40389, Nov. 6, 1986, as amended at 65 FR 2316, Jan. 14, 2000]

### § 874.5900 External upper esophageal sphincter compression device.

(a) *Identification.* An external upper esophageal sphincter compression device is a prescription device used to apply external pressure on the cricoid cartilage for the purpose of reducing the symptoms of laryngopharyngeal reflux disease.

(b) *Classification.* Class II (special controls). The special controls for this device are:

(1) The patient contacting components must be demonstrated to be bio-compatible.

(2) Non-clinical performance testing must demonstrate that the device performs as intended under anticipated conditions of use. The following performance characteristics must be demonstrated:

(i) Mechanical integrity testing (*e.g.*, tensile strength testing, fatigue testing) and

(ii) Shelf life testing.

(3) The technical specifications must include pressure measurement accuracy to characterize device performance.

(4) Clinical performance testing must document any adverse events observed during clinical use, and demonstrate that the device performs as intended under anticipated conditions of use.

(5) Labeling must include the following:

(i) Appropriate warnings and precautions,

(ii) A detailed summary of the clinical testing pertinent to use of the device including a detailed summary of the device-related complications or adverse events,

(iii) Detailed instructions on how to fit the device to the patient, and

(iv) Instructions for reprocessing of any reusable components.

(6) Patient labeling must be provided and must include:

(i) Relevant warnings, precautions, and adverse effects/complications,

(ii) Information on how to correctly wear the device,

(iii) The potential risks and benefits associated with the use of the device,

(iv) Alternative treatments, and

(v) Reprocessing instructions.

[80 FR 46194, Aug. 4, 2015]

**PART 876—GASTROENTEROLOGY-UROLOGY DEVICES**

**Subpart A—General Provisions**

Sec.

876.1 Scope.

876.3 Effective dates of requirement for pre-market approval.

876.9 Limitations of exemptions from section 510(k) of the Federal Food, Drug, and Cosmetic Act (the act).

**Subpart B—Diagnostic Devices**

876.1075 Gastroenterology-urology biopsy instrument.

876.1080 Gastroenterology-urology accessories to a biopsy instrument.

876.1300 Ingestible telemetric gastrointestinal capsule imaging system.

876.1330 Colon capsule endoscopy system.

876.1400 Stomach pH electrode.

876.1500 Endoscope and accessories.

876.1620 Urodynamics measurement system.

876.1725 Gastrointestinal motility monitoring system.

876.1735 Electrogastrography system.

876.1800 Urine flow or volume measuring system.

**Subpart C—Monitoring Devices**

876.2040 Enuresis alarm.

876.2050 Prostate lesion documentation system.

**Subpart D—Prosthetic Devices**

876.3350 Penile inflatable implant.

876.3500 Penile implant surgical accessories.

876.3630 Penile rigidity implant.

876.3750 Testicular prosthesis.

**Subpart E—Surgical Devices**

876.4020 Fiberoptic light ureteral catheter.

876.4270 Colostomy rod.

876.4300 Endoscopic electrosurgical unit and accessories.

876.4310 Endoscopic electrosurgical clip cutting system.

876.4340 High intensity ultrasound system for prostate tissue ablation.

876.4350 Fluid jet system for prostate tissue removal.

876.4370 Gastroenterology-urology evacuator.

876.4400 Hemorrhoidal ligator.

876.4480 Electrohydraulic lithotripter.

876.4500 Mechanical lithotripter.

876.4530 Gastroenterology-urology fiberoptic retractor.

876.4560 Ribdam.

876.4590 Interlocking urethral sound.

876.4620 Ureteral stent.

876.4630 Ureteral stent accessories.

876.4650 Water jet renal stone dislodger system.

876.4680 Ureteral stone dislodger.

876.4730 Manual gastroenterology-urology surgical instrument and accessories.

876.4770 Urethrotome.

876.4890 Urological table and accessories.

**Subpart F—Therapeutic Devices**

876.5010 Biliary catheter and accessories.  
 876.5011 Metallic biliary stent system for benign strictures.  
 876.5012 Biliary stent, drain, and dilator accessories.  
 876.5015 Pancreatic drainage stent and delivery system.  
 876.5020 External penile rigidity devices.  
 876.5025 Vibrator for climax control of premature ejaculation.  
 876.5030 Continent ileostomy catheter.  
 876.5090 Suprapubic urological catheter and accessories.  
 876.5100 Suprapubic catheter accessories.  
 876.5130 Urological catheter and accessories.  
 876.5140 Urethral insert with pump for bladder drainage.  
 876.5160 Urological clamp.  
 876.5210 Enema kit.  
 876.5220 Colonic irrigation system.  
 876.5250 Urine collector and accessories.  
 876.5270 Implanted electrical urinary continence device.  
 876.5280 Implanted mechanical/hydraulic urinary continence device.  
 876.5290 Implanted mechanical/hydraulic urinary continence device surgical accessories.  
 876.5310 Nonimplanted, peripheral electrical continence device.  
 876.5320 Nonimplanted electrical continence device.  
 876.5365 Esophageal dilator.  
 876.5450 Rectal dilator.  
 876.5470 Ureteral dilator.  
 876.5520 Urethral dilator.  
 876.5530 Implantable transprostatic tissue retractor system.  
 876.5540 Blood access device and accessories.  
 876.5550 Prostatic artery embolization device.  
 876.5600 Sorbent regenerated dialysate delivery system for hemodialysis.  
 876.5630 Peritoneal dialysis system and accessories.  
 876.5665 Water purification system for hemodialysis.  
 876.5820 Hemodialysis system and accessories.  
 876.5830 Hemodialyzer with disposable insert (Kiil type).  
 876.5860 High permeability hemodialysis system.  
 876.5870 Sorbent hemoperfusion system.  
 876.5880 Isolated kidney perfusion and transport system and accessories.  
 876.5885 Tissue culture media for human *ex vivo* tissue and cell culture processing applications.  
 876.5895 Ostomy irrigator.  
 876.5900 Ostomy pouch and accessories.  
 876.5920 Protective garment for incontinence.  
 876.5930 Rectal control system.  
 876.5955 Peritoneo-venous shunt.

876.5970 Hernia support.  
 876.5980 Gastrointestinal tube and accessories.  
 876.5981 Oral removable palatal space occupying device for weight management and/or weight loss.  
 876.5985 Enzyme packed cartridge.  
 876.5990 Extracorporeal shock wave lithotripter.

AUTHORITY: 21 U.S.C. 351, 360, 360c, 360e, 360j, 360l, 371.

SOURCE: 48 FR 53023, Nov. 23, 1983, unless otherwise noted.

**Subpart A—General Provisions**

EDITORIAL NOTE: Nomenclature changes to part 876 appear at 73 FR 35341, June 23, 2008.

**§ 876.1 Scope.**

(a) This part sets forth the classification of gastroenterology-urology devices intended for human use that are in commercial distribution.

(b) The identification of a device in a regulation in this part is not a precise description of every device that is, or will be, subject to the regulation. A manufacturer who submits a pre-market notification submission for a device under part 807 may not show merely that the device is accurately described by the section title and identification provisions of a regulation in this part, but shall state why the device is substantially equivalent to other devices, as required by § 807.87.

(c) To avoid duplicative listings, a gastroenterology-urology device that has two or more types of uses (e.g., used both as a diagnostic device and as a therapeutic device) is listed only in one subpart.

(d) References in this part to regulatory sections of the Code of Federal Regulations are to chapter I of title 21, unless otherwise noted.

(e) Guidance documents referenced in this part are available on the Internet at <http://www.fda.gov/MedicalDevices/DeviceRegulationandGuidance/GuidanceDocuments/default.htm>.

[52 FR 17737, May 11, 1987; 52 FR 22577, June 12, 1987, as amended at 69 FR 77623, Dec. 28, 2004; 78 FR 18233, Mar. 26, 2013]

**§ 876.3 Effective dates of requirement for premarket approval.**

A device included in this part that is classified into class III (premarket approval) shall not be commercially distributed after the date shown in the regulation classifying the device unless the manufacturer has an approval under section 515 of the act (unless an exemption has been granted under section 520(g)(2) of the act). An approval under section 515 of the act consists of FDA's issuance of an order approving an application for premarket approval (PMA) for the device or declaring completed a product development protocol (PDP) for the device.

(a) Before FDA requires that a device commercially distributed before the enactment date of the amendments, or a device that has been found substantially equivalent to such a device, has an approval under section 515 of the act FDA must promulgate a regulation under section 515(b) of the act requiring such approval, except as provided in paragraph (b) of this section. Such a regulation under section 515(b) of the act shall not be effective during the grace period ending on the 90th day after its promulgation or on the last day of the 30th full calendar month after the regulation that classifies the device into class III is effective, whichever is later. See section 501(f)(2)(B) of the act. Accordingly, unless an effective date of the requirement for premarket approval is shown in the regulation for a device classified into class III in this part, the device may be commercially distributed without FDA's issuance of an order approving a PMA or declaring completed a PDP for the device. If FDA promulgates a regulation under section 515(b) of the act requiring premarket approval for a device, section 501(f)(1)(A) of the act applies to the device.

(b) Any new, not substantially equivalent, device introduced into commercial distribution on or after May 28, 1976, including a device formerly marketed that has been substantially altered, is classified by statute (section 513(f) of the act) into class III without any grace period and FDA must have issued an order approving a PMA or declaring completed a PDP for the device before the device is commercially dis-

tributed unless it is reclassified. If FDA knows that a device being commercially distributed may be a "new" device as defined in this section because of any new intended use or other reasons, FDA may codify the statutory classification of the device into class III for such new use. Accordingly, the regulation for such a class III device states that as of the enactment date of the amendments, May 28, 1976, the device must have an approval under section 515 of the act before commercial distribution.

[52 FR 17737, May 11, 1987]

**§ 876.9 Limitations of exemptions from section 510(k) of the Federal Food, Drug, and Cosmetic Act (the act).**

The exemption from the requirement of premarket notification (section 510(k) of the act) for a generic type of class I or II device is only to the extent that the device has existing or reasonably foreseeable characteristics of commercially distributed devices within that generic type or, in the case of in vitro diagnostic devices, only to the extent that misdiagnosis as a result of using the device would not be associated with high morbidity or mortality. Accordingly, manufacturers of any commercially distributed class I or II device for which FDA has granted an exemption from the requirement of premarket notification must still submit a premarket notification to FDA before introducing or delivering for introduction into interstate commerce for commercial distribution the device when:

(a) The device is intended for a use different from the intended use of a legally marketed device in that generic type of device; e.g., the device is intended for a different medical purpose, or the device is intended for lay use where the former intended use was by health care professionals only;

(b) The modified device operates using a different fundamental scientific technology than a legally marketed device in that generic type of device; e.g., a surgical instrument cuts tissue with a laser beam rather than with a sharpened metal blade, or an in vitro diagnostic device detects or identifies infectious agents by using deoxyribonucleic acid (DNA) probe or

## § 876.1075

nucleic acid hybridization technology rather than culture or immunoassay technology; or

(c) The device is an in vitro device that is intended:

(1) For use in the diagnosis, monitoring, or screening of neoplastic diseases with the exception of immunohistochemical devices;

(2) For use in screening or diagnosis of familial or acquired genetic disorders, including inborn errors of metabolism;

(3) For measuring an analyte that serves as a surrogate marker for screening, diagnosis, or monitoring life-threatening diseases such as acquired immune deficiency syndrome (AIDS), chronic or active hepatitis, tuberculosis, or myocardial infarction or to monitor therapy;

(4) For assessing the risk of cardiovascular diseases;

(5) For use in diabetes management;

(6) For identifying or inferring the identity of a microorganism directly from clinical material;

(7) For detection of antibodies to microorganisms other than immunoglobulin G (IgG) or IgG assays when the results are not qualitative, or are used to determine immunity, or the assay is intended for use in matrices other than serum or plasma;

(8) For noninvasive testing as defined in § 812.3(k) of this chapter; and

(9) For near patient testing (point of care).

[65 FR 2316, Jan. 14, 2000]

### Subpart B—Diagnostic Devices

#### § 876.1075 Gastroenterology-urology biopsy instrument.

(a) *Identification.* A gastroenterology-urology biopsy instrument is a device used to remove, by cutting or aspiration, a specimen of tissue for microscopic examination. This generic type of device includes the biopsy punch, gastrointestinal mechanical biopsy instrument, suction biopsy instrument, gastro-urology biopsy needle and needle set, and nonelectric biopsy forceps. This section does not apply to biopsy instruments that have specialized uses in other medical specialty areas and that are covered by classification regu-

## 21 CFR Ch. I (4–1–20 Edition)

lations in other parts of the device classification regulations.

(b) *Classification.* (1) Class II (performance standards).

(2) Class I for the biopsy forceps cover and the non-electric biopsy forceps. The devices subject to this paragraph (b)(2) are exempt from the premarket notification procedures in subpart E of part 807 of this chapter subject to the limitations in § 876.9.

[48 FR 53023, Nov. 23, 1983, as amended at 61 FR 1122, Jan. 16, 1996; 66 FR 38801, July 25, 2001]

#### § 876.1080 Gastroenterology-urology accessories to a biopsy instrument.

(a) *Identification.* A gastroenterology-urology accessory to a biopsy instrument is an accessory used to remove a specimen of tissue for microscopic examination by cutting or aspiration. This generic type of device includes a syringe for specimen aspiration and a biopsy channel adaptor. This device does not include accessories to biopsy instruments used in other medical specialty areas.

(b) *Classification.* Class I (general controls). The device is exempt from the premarket notification procedures in subpart E of part 807 of this chapter subject to the limitations in § 876.9.

[84 FR 14869, Apr. 12, 2019]

#### § 876.1300 Ingestible telemetric gastrointestinal capsule imaging system.

(a) *Identification.* An ingestible telemetric gastrointestinal capsule imaging system is used for visualization of the small bowel mucosa as an adjunctive tool in the detection of abnormalities of the small bowel. The device captures images of the small bowel with a wireless camera contained in a capsule. This device includes an ingestible capsule (containing a light source, camera, transmitter, and battery), an antenna array, a receiving/recording unit, a data storage device, computer software to process the images, and accessories.

(b) *Classification.* Class II (special controls). The special control is FDA's guidance, "Class II Special Controls

Guidance Document: Ingestible Tele-metric Gastrointestinal Capsule Imaging Systems; Final Guidance for Industry and FDA.”

[67 FR 3433, Jan. 24, 2002]

**§ 876.1330 Colon capsule endoscopy system.**

(a) *Identification.* A prescription, single-use ingestible capsule designed to acquire video images during natural propulsion through the digestive system. It is specifically designed to visualize the colon for the detection of polyps. It is intended for use only in patients who had an incomplete optical colonoscopy with adequate preparation, and a complete evaluation of the colon was not technically possible.

(b) *Classification.* Class II (special controls). The special controls for this device are:

(1) The capsule must be demonstrated to be biocompatible.

(2) Non-clinical testing data must demonstrate the mechanical and functional integrity of the device under physically stressed conditions. The following performance characteristics must be tested and detailed protocols must be provided for each test:

(i) Bite test to ensure that the capsule can withstand extreme cases of biting.

(ii) pH resistance test to evaluate integrity of the capsule when exposed to a range of pH values.

(iii) Battery life test to demonstrate that the capsule's operating time is not constrained by the battery capacity.

(iv) Shelf-life testing to demonstrate that the device performs as intended at the proposed shelf-life date.

(v) Optical testing to evaluate fundamental image quality characteristics such as resolution, field of view, depth of field, distortion, signal-to-noise ratio, uniformity, and image artifacts. A test must be performed to evaluate the potential of scratches, caused by travelling through the gastrointestinal tract, on the transparent window of the capsule and their impact on the optical and color performance.

(vi) An optical safety analysis must be performed based on maximum (worst-case) light exposure to internal gastrointestinal mucosa, and covering ultraviolet, visible, and near-infrared

ranges, as appropriate. A mitigation analysis must be provided.

(vii) A color performance test must be provided to compare the color differences between the input scene and output image.

(viii) The video viewer must clearly present the temporal or spatial relationship between any two frames as a real-time lapse or a travel distance. The video viewer must alert the user when the specific video interval is captured at a frame rate lower than the nominal one due to communication errors.

(ix) A performance test evaluating the latency caused by any adaptive algorithm such as adjustable frame rate must be provided.

(x) If the capsule includes a localization module, a localization performance test must be performed to verify the accuracy and precision of locating the capsule position within the colon.

(xi) A data transmission test must be performed to verify the robustness of the data transmission between the capsule and the recorder. Controlled signal attenuation should be included for simulating a non-ideal environment.

(xii) Software validation, verification, and hazards analysis must be provided.

(xiii) Electrical equipment safety, including thermal and mechanical safety and electromagnetic compatibility (EMC) testing must be performed. If the environments of intended use include locations outside of hospitals and clinics, appropriate higher immunity test levels must be used. Labeling must include appropriate EMC information.

(xiv) Information demonstrating immunity from wireless hazards.

(3) The clinical performance characteristics of the device for the detection of colon polyps must be established. Demonstration of the performance characteristics must include assessment of positive percent agreement and negative percent agreement compared to a clinically acceptable alternative structural imaging method.

(4) Clinician labeling must include:

(i) Specific instructions and the clinical and technical expertise needed for the safe use of the device.

§ 876.1400

21 CFR Ch. I (4-1-20 Edition)

(ii) A detailed summary of the clinical testing pertinent to use of the device, including the percentage of patients in which a polyp was correctly identified by capsule endoscopy, but also the percent of patients in which the capsule either missed or falsely identified a polyp with respect to the clinically acceptable alternative structural imaging method.

(iii) The colon cleansing procedure.

(iv) A detailed summary of the device technical parameters.

(v) A detailed summary of the device- and procedure-related complications pertinent to use of the device.

(vi) An expiration date/shelf life.

(5) Patient labeling must include:

(i) An explanation of the device and the mechanism of operation.

(ii) Patient preparation procedure.

(iii) A brief summary of the clinical study. The summary should not only include the percentage of patients in which a polyp was correctly identified by capsule endoscopy, but also the percent of patients in which the capsule either missed or falsely identified a polyp with respect to the clinically acceptable alternative structural imaging method.

(iv) A summary of the device- and procedure-related complications pertinent to use of the device.

[79 FR 28403, May 16, 2014]

§ 876.1400 Stomach pH electrode.

(a) Identification. A stomach pH electrode is a device used to measure intragastric and intraesophageal pH (hydrogen ion concentration). The pH electrode is at the end of a flexible lead which may be inserted into the esophagus or stomach through the patient's mouth. The device may include an integral gastrointestinal tube.

(b) Classification. Class I. The device is exempt from the premarket notification procedures in subpart E of part 807 of this chapter.

[48 FR 53023, Nov. 23, 1983, as amended at 61 FR 1122, Jan. 16, 1996]

§ 876.1500 Endoscope and accessories.

(a) Identification. An endoscope and accessories is a device used to provide access, illumination, and allow observation or manipulation of body cav-

ities, hollow organs, and canals. The device consists of various rigid or flexible instruments that are inserted into body spaces and may include an optical system for conveying an image to the user's eye and their accessories may assist in gaining access or increase the versatility and augment the capabilities of the devices. Examples of devices that are within this generic type of device include cleaning accessories for endoscopes, photographic accessories for endoscopes, nonpowered anosopes, binocular attachments for endoscopes, pocket battery boxes, flexible or rigid choledochoscopes, colonoscopes, diagnostic cystoscopes, cystourethroscopes, enteroscopes, esophagogastroduodenoscopes, rigid esophagoscopes, fiberoptic illuminators for endoscopes, incandescent endoscope lamps, biliary pancreatoscopes, proctoscopes, resectoscopes, nephroscopes, sigmoidoscopes, ureteroscopes, urethroscopes, endomagnetic retrievers, cytology brushes for endoscopes, and lubricating jelly for transurethral surgical instruments. This section does not apply to endoscopes that have specialized uses in other medical specialty areas and that are covered by classification regulations in other parts of the device classification regulations.

(b) Classification—(1) Class II (special controls). The device, when it is an endoscope disinfectant basin, which consists solely of a container that holds disinfectant and endoscopes and accessories; an endoscopic magnetic retriever intended for single use; sterile scissors for cystoscope intended for single use; a disposable, non-powered endoscopic grasping/cutting instrument intended for single use; a diagnostic incandescent light source; a fiberoptic photographic light source; a routine fiberoptic light source; an endoscopic sponge carrier; a xenon arc endoscope light source; an endoscope transformer; an LED light source; or a gastroenterology-urology endoscopic guidewire, is exempt from the premarket notification procedures in subpart E of part 807 of this chapter subject to the limitations in § 876.9.

(2) Class I for the photographic accessories for endoscope, miscellaneous bulb adapter for endoscope, binocular



attachment for endoscope, eyepiece attachment for prescription lens, teaching attachment, inflation bulb, measuring device for panendoscope, photographic equipment for physiologic function monitor, special lens instrument for endoscope, smoke removal tube, rechargeable battery box, pocket battery box, bite block for endoscope, and cleaning brush for endoscope. The devices subject to this paragraph (b)(2) are exempt from the premarket notification procedures in subpart E of part 807 of this chapter, subject to the limitations in § 876.9.

[48 FR 53023, Nov. 23, 1983, as amended at 61 FR 1122, Jan. 16, 1996; 66 FR 38801, July 25, 2001; 83 FR 25914, June 5, 2018; 84 FR 71813, Dec. 30, 2019]

**§ 876.1620 Urodynamics measurement system.**

(a) *Identification.* A urodynamics measurement system is a device used to measure volume and pressure in the urinary bladder when it is filled through a catheter with carbon dioxide or water. The device controls the supply of carbon dioxide or water and may also record the electrical activity of the muscles associated with urination. The device system may include transducers, electronic signal conditioning and display equipment, a catheter withdrawal device to enable a urethral pressure profile to be obtained, and special catheters for urethral profilometry and electrodes for electromyography. This generic type of device includes the cystometric gas (carbon dioxide) device, the cystometric hydraulic device, and the electrical recording cystometer, but excludes any device that uses air to fill the bladder.

(b) *Classification.* Class II (special controls). The device is exempt from the premarket notification procedures in subpart E of part 807 of this chapter subject to § 876.9.

[48 FR 53023, Nov. 23, 1983, as amended at 63 FR 59228, Nov. 3, 1998]

**§ 876.1725 Gastrointestinal motility monitoring system.**

(a) *Identification.* A gastrointestinal motility monitoring system is a device used to measure peristaltic activity or pressure in the stomach or esophagus

by means of a probe with transducers that is introduced through the mouth into the gastrointestinal tract. The device may include signal conditioning, amplifying, and recording equipment. This generic type of device includes the esophageal motility monitor and tube, the gastrointestinal motility (electrical) system, and certain accessories, such as a pressure transducer, amplifier, and external recorder.

(b) *Classification.* Class II (performance standards).

**§ 876.1735 Electrogastrography system.**

(a) *Identification.* An electrogastrography system (EGG) is a device used to measure gastric myoelectrical activity as an aid in the diagnosis of gastric motility disorders. The device system includes the external recorder, amplifier, skin electrodes, strip chart, cables, analytical software, and other accessories.

(b) *Classification.* Class II (Special Controls). The special controls are as follows:

(1) The sale, distribution and use of this device are restricted to prescription use in accordance with § 801.109 of this chapter.

(2) The labeling must include specific instructions:

(i) To describe proper patient set-up prior to the start of the test, including the proper placement of electrodes;

(ii) To describe how background data should be gathered and used to eliminate artifact in the data signal;

(iii) To describe the test protocol (including the measurement of baseline data) that may be followed to obtain the EGG signal; and

(iv) To explain how data results may be interpreted.

(3) The device design should ensure that the EGG signal is distinguishable from background noise that may interfere with the true gastric myoelectric signal.

(4) Data should be collected to demonstrate that the device has adequate precision and the EGG signal is reproducible and is interpretable.

[64 FR 51444, Sept. 23, 1999]

**§ 876.1800 Urine flow or volume measuring system.**

(a) *Identification.* A urine flow or volume measuring system is a device that measures directly or indirectly the volume or flow of urine from a patient, either during the course of normal urination or while the patient is catheterized. The device may include a drip chamber to reduce the risk of retrograde bacterial contamination of the bladder and a transducer and electrical signal conditioning and display equipment. This generic type of device includes the electrical urinometer, mechanical urinometer, nonelectric urinometer, disposable nonelectric urine flow rate measuring device, and uroflowmeter.

(b) *Classification.* (1) Class II (special controls). The device is exempt from the premarket notification procedures in subpart E of part 807 of this chapter subject to § 876.9.

[48 FR 53023, Nov. 23, 1983, as amended at 61 FR 1122, Jan. 16, 1996; 63 FR 59228, Nov. 3, 1998]

**Subpart C—Monitoring Devices****§ 876.2040 Enuresis alarm.**

(a) *Identification.* An enuresis alarm is a device intended for use in treatment of bedwetting. Through an electrical trigger mechanism, the device sounds an alarm when a small quantity of urine is detected on a sensing pad. This generic type of device includes conditioned response enuresis alarms.

(b) *Classification.* Class II (special controls). The device is exempt from the premarket notification procedures in subpart E of part 807 of this chapter subject to § 876.9.

[48 FR 53023, Nov. 23, 1983, as amended at 63 FR 59228, Nov. 3, 1998]

**§ 876.2050 Prostate lesion documentation system.**

(a) *Identification.* A prostate lesion documentation system is a prescription device intended for use in producing an image of the prostate as an aid in documenting prostate abnormalities previously identified during a digital rectal examination. The device uses pressure sensors and image reconstruction software to produce a prostate image

that highlights regional differences in intraprostatic tissue elasticity or stiffness. The device is limited to use as a documentation tool and is not intended for diagnostic purposes or for influencing any clinical decisions.

(b) *Classification.* Class II (special controls). The special controls for this device are:

(1) Non-clinical and clinical performance testing must demonstrate the accuracy and reproducibility of the constructed image.

(2) Appropriate analysis/testing must validate electromagnetic compatibility, electrical safety, thermal safety, and mechanical safety.

(3) Appropriate software verification, validation, and hazard analysis must be performed.

(4) All elements of the device that may contact the patient must be demonstrated to be biocompatible.

(5) Methods and instructions for reprocessing of any reusable components must be properly validated.

(6) The labeling must include specific information needed to ensure proper use of the device.

[80 FR 72900, Nov. 23, 2015]

**Subpart D—Prosthetic Devices****§ 876.3350 Penile inflatable implant.**

(a) *Identification.* A penile inflatable implant is a device that consists of two inflatable cylinders implanted in the penis, connected to a reservoir filled with radiopaque fluid implanted in the abdomen, and a subcutaneous manual pump implanted in the scrotum. When the cylinders are inflated, they provide rigidity to the penis. This device is used in the treatment of erectile impotence.

(b) *Classification.* Class III (premarket approval).

(c) *Date premarket approval application (PMA) or notice of completion of a product development protocol (PDP) is required.* A PMA or a notice of completion of a PDP is required to be filed with the Food and Drug Administration on or before July 11, 2000, for any penile inflatable implant that was in commercial distribution before May 28, 1976, or that has, on or before July 11, 2000, been found to be substantially

equivalent to a penile inflatable implant that was in commercial distribution before May 28, 1976. Any other penile inflatable implant shall have an approved PMA or a declared completed PDP in effect before being placed in commercial distribution.

[48 FR 53023, Nov. 23, 1983, as amended at 52 FR 17738, May 11, 1987; 65 FR 19658, Apr. 12, 2000]

**§ 876.3500 Penile implant surgical accessories.**

(a) *Identification.* Penile implant surgical accessories are manual devices designed to be used for surgical procedures associated with the implantation of a penile inflatable implant or penile rigidity implant. This generic type of device includes the cylinder sizer, cylinder insertion tool and needle, device placement tool, connector assembly tool, incision closing tool, corporeal dilator, tubing passer, measurement tool or tape, tubing plug, blunt needle, and hemostat shod tubing.

(b) *Classification.* Class I (general controls). The device is exempt from the premarket notification procedures in subpart E of part 807 of this chapter subject to the limitations in § 876.9.

[84 FR 14869, Apr. 12, 2019]

**§ 876.3630 Penile rigidity implant.**

(a) *Identification.* A penile rigidity implant is a device that consists of a pair of semi-rigid rods implanted in the corpora cavernosa of the penis to provide rigidity. It is intended to be used in men diagnosed as having erectile dysfunction.

(b) *Classification.* Class II. The special control for this device is the FDA guidance entitled "Guidance for the Content of Premarket Notifications for Penile Rigidity Implants."

[65 FR 4882, Feb. 2, 2000]

**§ 876.3750 Testicular prosthesis.**

(a) *Identification.* A testicular prosthesis is an implanted device that consists of a solid or gel-filled silicone rubber prosthesis that is implanted surgically to resemble a testicle.

(b) *Classification.* Class III (premarket approval).

(c) *Date premarket approval application (PMA) or notice of product development*

*protocol (PDP) is required.* A PMA or notice of completion of a PDP is required to be filed with the Food and Drug Administration on or before July 5, 1995, for any testicular prosthesis that was in commercial distribution before May 28, 1976, or that has on or before July 5, 1995, been found to be substantially equivalent to a testicular prosthesis that was in commercial distribution before May 28, 1976. Any other testicular prosthesis shall have an approved PMA or a declared completed PDP in effect before being placed in commercial distribution.

[48 FR 53023, Nov. 23, 1983, as amended at 52 FR 17738, May 11, 1987; 60 FR 17216, Apr. 5, 1995]

**Subpart E—Surgical Devices**

**§ 876.4020 Fiberoptic light ureteral catheter.**

(a) *Identification.* A fiberoptic light ureteral catheter is a device that consists of a fiberoptic bundle that emits light throughout its length and is shaped so that it can be inserted into the ureter to enable the path of the ureter to be seen during lower abdominal or pelvic surgery.

(b) *Classification.* Class II (special controls). The device is exempt from the premarket notification procedures in subpart E of part 807 of this chapter subject to the limitations in § 876.9.

[48 FR 53023, Nov. 23, 1983, as amended at 84 FR 71813, Dec. 30, 2019]

**§ 876.4270 Colostomy rod.**

(a) *Identification.* A colostomy rod is a device used during the loop colostomy procedure. A loop of colon is surgically brought out through the abdominal wall and the stiff colostomy rod is placed through the loop temporarily to keep the colon from slipping back through the surgical opening.

(b) *Classification.* Class II (special controls). The device is exempt from the premarket notification procedures in subpart E of part 807 of this chapter subject to the limitations in § 876.9.

[48 FR 53023, Nov. 23, 1983, as amended at 84 FR 71813, Dec. 30, 2019]

**§ 876.4300**

**21 CFR Ch. I (4–1–20 Edition)**

**§ 876.4300 Endoscopic electro-surgical unit and accessories.**

(a) *Identification.* An endoscopic electro-surgical unit and accessories is a device used to perform electro-surgical procedures through an endoscope. This generic type of device includes the electro-surgical generator, patient plate, electric biopsy forceps, electrode, flexible snare, electro-surgical alarm system, electro-surgical power supply unit, electrical clamp, self-opening rigid snare, flexible suction coagulator electrode, patient return wristlet, contact jelly, adaptor to the cord for transurethral surgical instruments, the electric cord for transurethral surgical instruments, and the transurethral desiccator.

(b) *Classification.* Class II (performance standards).

**§ 876.4310 Endoscopic electro-surgical clip cutting system.**

(a) *Identification.* An endoscopic electro-surgical clip cutting system is a prescription device that applies electrical energy to fragment metallic clips, which are devices placed in the digestive tract to close gastrointestinal perforations, hemorrhages, or perform resection. The system includes instruments that are then used to remove the fragmented clips from the digestive tract.

(b) *Classification.* Class II (special controls). The special controls for this device are:

(1) Non-clinical performance testing must demonstrate that the device performs as intended under anticipated conditions of use. The following performance characteristics must be tested:

(i) Performance bench testing to evaluate the functionality (including stress, compatibility, usability, and reliability) of the device during use;

(ii) Electrical and thermal safety testing; and

(iii) Electromagnetic compatibility testing.

(2) Animal testing must evaluate tissue damage, including thermal effects, during the clip removal procedure. This testing must also evaluate usability and effectiveness of the device.

(3) The patient-contacting components of the device must be demonstrated to be biocompatible.

(4) Performance data must demonstrate the sterility of the device components intended to be provided sterile.

(5) Performance data must support shelf life by demonstrating continued sterility of the device (or the sterile components), package integrity, and device functionality over the labeled shelf life.

(6) Labeling of the device must include:

(i) Instructions for use, and

(ii) A shelf life for single use components.

[83 FR 27703, June 14, 2018]

**§ 876.4340 High intensity ultrasound system for prostate tissue ablation.**

(a) *Identification.* A high intensity ultrasound system for prostate tissue ablation is a prescription device that transmits high intensity therapeutic ultrasound energy into the prostate to thermally ablate a defined, targeted volume of tissue, performed under imaging guidance. This classification does not include devices that are intended for the treatment of any specific prostate disease and does not include devices that are intended to ablate non-prostatic tissues/organs.

(b) *Classification.* Class II (special controls). The special controls for this device are:

(1) Non-clinical performance data must demonstrate that the device performs as intended under anticipated conditions of use. The following performance characteristics must be tested:

(i) Characterization of acoustic pressure and power output at clinically relevant levels;

(ii) Measurement of targeting accuracy and reproducibility of high intensity ultrasound output;

(iii) Ultrasound-induced heating verification testing at target and non-target tissues;

(iv) Electrical safety testing; and

(v) Electromagnetic compatibility testing.

(2) Software verification, validation, and hazard analysis must be performed.

(3) The elements of the device that may contact the patient's mucosal tissue must be demonstrated to be biocompatible.

(4) Performance data must demonstrate the sterility of the device components that contact the patient's mucosal tissue.

(5) Performance data must support shelf life by demonstrating continued sterility of the device or the sterile components, package integrity, and device functionality over the identified shelf life.

(6) Performance data must support the instructions for reprocessing all reusable components.

(7) *In vivo* testing must demonstrate that the device thermally ablates targeted tissue in a controlled manner without thermal injury to adjacent, non-target tissues.

(8) Clinical testing must document the adverse event profile, provide evidence of prostatic ablation, and demonstrate that the device performs as intended under anticipated conditions of use.

(9) Training must be provided so that upon completion of the training program, the physician can:

(i) Use all safety features of the device;

(ii) Accurately target the high intensity ultrasound energy within the desired region of the prostate; and

(iii) Perform the ablation procedure in a manner that minimizes damage to non-target tissues.

(10) Labeling must include:

(i) A section that summarizes the clinical testing results, including the adverse event profile and evidence of prostate ablation achieved; and

(ii) An expiration date or shelf life for single use components.

[82 FR 45727, Oct. 2, 2017]

**§ 876.4350 Fluid jet system for prostate tissue removal.**

(a) *Identification.* A fluid jet system for prostate tissue removal is a prescription device intended for the resection and removal of prostatic tissue for the treatment of benign prostatic hyperplasia. The device cuts tissue by using a pressurized jet of fluid delivered to the prostatic urethra. The device is able to image the treatment

area, or pairs with an imaging modality, to monitor treatment progress.

(b) *Classification.* Class II (special controls). The special controls for this device are:

(1) Clinical performance testing must evaluate the following:

(i) All adverse events associated with the device, and

(ii) Improvement in lower urinary tract symptoms (LUTS).

(2) Physician training must be provided that includes:

(i) Information on key aspects and use of the device, and

(ii) Information on how to override or stop resection.

(3) Animal testing must demonstrate that the device resects targeted tissue in a controlled manner without injury to adjacent non-target tissues.

(4) Non-clinical performance data must demonstrate that the device performs as intended under anticipated conditions of use. The following performance characteristics must be tested:

(i) Measurement of targeting accuracy and reproducibility of high velocity fluid jet, and

(ii) High pressure fluid jet verification testing at target and non-target tissues.

(5) Software verification, validation, and hazard analysis must be performed.

(6) The patient-contacting elements of the device must be demonstrated to be biocompatible.

(7) Performance data must demonstrate the electrical safety and electromagnetic compatibility of the device.

(8) Performance data must demonstrate the sterility of the patient-contacting components of the device.

(9) Performance data must support the shelf life of the device by demonstrating continued sterility, package integrity, and device functionality over the identified shelf life.

(10) Performance data must validate the instructions for reprocessing and reliability of reusable components.

(11) Labeling must include the following:

(i) A section that summarizes the clinical testing results, including the adverse event profile and improvement in LUTS;

## § 876.4370

(ii) A shelf life for single use components;

(iii) A use life for reusable components; and

(iv) Reprocessing instructions for reusable components.

[83 FR 27897, June 15, 2018]

### § 876.4370 Gastroenterology-urology evacuator.

(a) *Identification.* A gastroenterology-urology evacuator is a device used to remove debris and fluids during gastroenterological and urological procedures by drainage, aspiration, or irrigation. This generic type of device includes the fluid evacuator system, manually powered bladder evacuator, and the AC-powered vacuum pump.

(b) *Classification.* (1) Class II (special controls) for the gastroenterology-urology evacuator when other than manually powered. The device is exempt from the premarket notification procedures in subpart E of part 807 of this chapter subject to § 876.9.

(2) Class I for the gastroenterology-urology evacuator when manually powered. The device subject to this paragraph (b)(2) is exempt from the premarket notification procedures in subpart E of part 807 of this chapter.

[48 FR 53023, Nov. 23, 1983, as amended at 54 FR 25049, June 12, 1989; 63 FR 59228, Nov. 3, 1998]

### § 876.4400 Hemorrhoidal ligator.

(a) *Identification.* A hemorrhoidal ligator is a device used to cut off the blood flow to hemorrhoidal tissue by means of a ligature or band placed around the hemorrhoid.

(b) *Classification.* Class II (special controls). Except for a hemostatic metal clip intended for use in the gastrointestinal tract, the device is exempt from the premarket notification procedures in subpart E of part 807 of this chapter subject to the limitations in § 876.9.

[48 FR 53023, Nov. 23, 1983, as amended at 84 FR 71813, Dec. 30, 2019]

### § 876.4480 Electrohydraulic lithotripter.

(a) *Identification.* An electrohydraulic lithotripter is an AC-powered device used to fragment urinary bladder

## 21 CFR Ch. I (4–1–20 Edition)

stones. It consists of a high voltage source connected by a cable to a bipolar electrode that is introduced into the urinary bladder through a cystoscope. The electrode is held against the stone in a water-filled bladder and repeated electrical discharges between the two poles of the electrode cause electrohydraulic shock waves which disintegrate the stone.

(b) *Classification.* Class II. The special control for this device is FDA's "Guidance for the Content of Premarket Notifications for Intracorporeal Lithotripters."

[48 FR 53023, Nov. 23, 1983, as amended at 52 FR 17738, May 11, 1987; 65 FR 17145, Mar. 31, 2000]

### § 876.4500 Mechanical lithotripter.

(a) *Identification.* A mechanical lithotripter is a device with steel jaws that is inserted into the urinary bladder through the urethra to grasp and crush bladder stones.

(b) *Classification.* Class II (special controls). The device, when it is a biliary mechanical lithotripter, is exempt from the premarket notification procedures in subpart E of part 807 of this chapter subject to the limitations in § 876.9.

[48 FR 53023, Nov. 23, 1983, as amended at 84 FR 71813, Dec. 30, 2019]

### § 876.4530 Gastroenterology-urology fiberoptic retractor.

(a) *Identification.* A gastroenterology-urology fiberoptic retractor is a device that consists of a mechanical retractor with a fiberoptic light system that is used to illuminate deep surgical sites.

(b) *Classification.* Class I (general controls). The device is exempt from the premarket notification procedures in subpart E of part 807 of this chapter subject to the limitations in § 876.9.

[48 FR 53023, Nov. 23, 1983, as amended at 54 FR 25049, June 12, 1989; 66 FR 38801, July 25, 2001]

### § 876.4560 Ribdam.

(a) *Identification.* A ribdam is a device that consists of a broad strip of latex with supporting ribs used to drain surgical wounds where copious urine drainage is expected.

(b) *Classification*. Class I (general controls). The device is exempt from the premarket notification procedures in subpart E of part 807 of this chapter subject to the limitations in § 876.9.

[48 FR 53023, Nov. 23, 1983, as amended at 54 FR 25049, June 12, 1989; 66 FR 38801, July 25, 2001]

**§ 876.4590 Interlocking urethral sound.**

(a) *Identification*. An interlocking urethral sound is a device that consists of two metal sounds (elongated instruments for exploring or sounding body cavities) with interlocking ends, such as with male and female threads or a rounded point and mating socket, used in the repair of a ruptured urethra. The device may include a protective cap to fit over the metal threads.

(b) *Classification*. Class I (general controls). The device is exempt from the premarket notification procedures in subpart E of part 807 of this chapter subject to the limitations in § 876.9.

[48 FR 53023, Nov. 23, 1983, as amended at 61 FR 1122, Jan. 16, 1996; 66 FR 38801, July 25, 2001]

**§ 876.4620 Ureteral stent.**

(a) *Identification*. A ureteral stent is a tube-like implanted device that is inserted into the ureter to provide ureteral rigidity and allow the passage of urine. The device may have finger-like protrusions or hooked ends to keep the tube in place. It is used in the treatment of ureteral injuries and ureteral obstruction.

(b) *Classification*. Class II (performance standards).

**§ 876.4630 Ureteral stent accessories.**

(a) *Identification*. Ureteral stent accessories aid in the insertion of the ureteral stent that is placed into the ureter to provide ureteral rigidity and allow the passage of urine. This generic type of device includes the stent positioner, wire guide, and pigtail straightener.

(b) *Classification*. Class I (general controls). The device is exempt from the premarket notification procedures in subpart E of part 807 of this chapter subject to the limitations in § 876.9.

[84 FR 14870, Apr. 12, 2019]

**§ 876.4650 Water jet renal stone dislodger system.**

(a) *Identification*. A water jet renal stone dislodger system is a device used to dislodge stones from renal calyces (recesses of the pelvis of the kidney) by means of a pressurized stream of water through a conduit. The device is used in the surgical removal of kidney stones.

(b) *Classification*. Class II (special controls). The device is exempt from the premarket notification procedures in subpart E of part 807 of this chapter subject to § 876.9.

[48 FR 53023, Nov. 23, 1983, as amended at 63 FR 59228, Nov. 3, 1998]

**§ 876.4680 Ureteral stone dislodger.**

(a) *Identification*. A ureteral stone dislodger is a device that consists of a bougie or a catheter with an expandable wire basket near the tip, a special flexible tip, or other special construction. It is inserted through a cystoscope and used to entrap and remove stones from the ureter. This generic type of device includes the metal basket and the flexible ureteral stone dislodger.

(b) *Classification*. Class II (special controls). The device is exempt from the premarket notification procedures in subpart E of part 807 of this chapter subject to § 876.9.

[48 FR 53023, Nov. 23, 1983, as amended at 63 FR 59228, Nov. 3, 1998]

**§ 876.4730 Manual gastroenterology-urology surgical instrument and accessories.**

(a) *Identification*. A manual gastroenterology-urology surgical instrument and accessories is a device designed to be used for gastroenterological and urological surgical procedures. The device may be nonpowered, hand-held, or hand-manipulated. Manual gastroenterology-urology surgical instruments include the biopsy forceps cover, biopsy tray without biopsy instruments, line clamp, nonpowered rectal probe, nonelectrical clamp, colostomy spur-crushers, locking device for intestinal clamp, needle holder, gastro-urology hook, gastro-urology probe and director, nonself-retaining

## § 876.4770

retractor, laparotomy rings, nonelectrical snare, rectal specula, bladder neck spreader, self-retaining retractor, and scoop. A manual surgical instrument that is intended specifically for use as an aid in the insertion, placement, fixation, or anchoring of surgical mesh during urogynecologic procedures are classified under § 884.4910 of this chapter.

(b) *Classification.* Class I (general controls). The device is exempt from the premarket notification procedures in subpart E of part 807 of this chapter subject to the limitations in § 876.9.

[48 FR 53023, Nov. 23, 1983, as amended at 54 FR 25049, June 12, 1989; 66 FR 38801, July 25, 2001; 82 FR 12171, Mar. 1, 2017]

## § 876.4770 Urethrotome.

(a) *Identification.* A urethrotome is a device that is inserted into the urethra and used to cut urethral strictures and enlarge the urethra. It is a metal instrument equipped with a dorsal-fin cutting blade which can be elevated from its sheath. Some urethrotomes incorporate an optical channel for visual control.

(b) *Classification.* Class II (special controls). The device is exempt from the premarket notification procedures in subpart E of part 807 of this chapter subject to the limitations in § 876.9.

[48 FR 53023, Nov. 23, 1983, as amended at 84 FR 71813, Dec. 30, 2019]

## § 876.4890 Urological table and accessories.

(a) *Identification.* A urological table and accessories is a device that consists of a table, stirrups, and belts used to support a patient in a suitable position for endoscopic procedures of the lower urinary tract. The table can be adjusted into position manually or electrically.

(b) *Classification.* (1) Class II (special controls) for the electrically powered urological table and accessories. The device is exempt from the premarket notification procedures in subpart E of part 807 of this chapter subject to § 876.9.

(2) Class I for the manually powered table and accessories, and for stirrups for electrically powered table. The device subject to this paragraph (b)(2) is exempt from the premarket notification

## 21 CFR Ch. I (4–1–20 Edition)

procedures in subpart E of part 807 of this chapter subject to the limitations in § 876.9.

[48 FR 53023, Nov. 23, 1983, as amended at 61 FR 1122, Jan. 16, 1996; 63 FR 59228, Nov. 3, 1998; 66 FR 38801, July 25, 2001]

## Subpart F—Therapeutic Devices

### § 876.5010 Biliary catheter and accessories.

(a) *Identification.* A biliary catheter and accessories is a tubular flexible device used for temporary or prolonged drainage of the biliary tract, for splinting of the bile duct during healing, or for preventing stricture of the bile duct. This generic type of device may include a bile collecting bag that is attached to the biliary catheter by a connector and fastened to the patient with a strap.

(b) *Classification.* Class II (special controls). The device, when it is a bile collecting bag or a surgical biliary catheter that does not include a balloon component, is exempt from the premarket notification procedures in subpart E of part 807 of this chapter subject to the limitations in § 876.9.

[48 FR 53023, Nov. 23, 1983, as amended at 84 FR 71814, Dec. 30, 2019]

### § 876.5011 Metallic biliary stent system for benign strictures.

(a) *Identification.* A metallic biliary stent system for benign strictures is a prescription device intended for the treatment of benign biliary strictures. The biliary stents are intended to be left indwelling for a limited amount of time and subsequently removed. The device consists of a metallic stent and a delivery system intended to place the biliary stent in the bile duct. This device type is not intended for use in the vasculature.

(b) *Classification.* Class II (special controls). The special controls for this device are:

(1) Clinical performance testing must demonstrate or provide the following:

(i) The ability to safely place and subsequently remove the stent after the maximum labeled indwell period.

(ii) All adverse event data including bile duct obstruction and trauma to the bile duct.



(iii) The stent resolves strictures during the maximum labeled indwell period.

(iv) Stricture resolution is maintained post-stent removal.

(2) Non-clinical performance testing must demonstrate that the device performs as intended under anticipated conditions of use. The following performance characteristics must be demonstrated:

(i) Corrosion testing to demonstrate that the stent maintains its integrity during indwell and does not release potentially toxic levels of leachables.

(ii) Stent dimensional testing supports the intended use.

(iii) Compression and expansion forces must be characterized.

(iv) The delivery catheter must deliver the stent to the intended location and the stent must not be adversely impacted by the delivery catheter during deployment and catheter withdrawal.

(v) The delivery system must withstand clinically anticipated forces.

(vi) Compatibility in a magnetic resonance environment.

(3) All patient contacting components of the device must be demonstrated to be biocompatible.

(4) Performance data must demonstrate the sterility of the device components intended to be provided sterile.

(5) Shelf life testing must demonstrate that the device maintains its performance characteristics and that packaging maintains sterility for the duration of the labeled shelf life.

(6) Labeling for the device must include:

(i) A detailed summary of the clinical testing including device effectiveness, and device- and procedure-related adverse events.

(ii) Appropriate warning(s) to accurately ensure usage of the device for the intended patient population.

(iii) Shelf life.

(iv) Compatibility information for use in the magnetic resonance environment.

(v) Stent foreshortening information supported by dimensional testing.

[81 FR 45231, July 13, 2016]

#### § 876.5012 Biliary stent, drain, and dilator accessories.

(a) *Identification.* Biliary stent, drain, and dilator accessories are manual devices that aid in the introduction and connection of biliary stents, drains, or dilators. This generic type of device includes the guiding catheter, pushing catheter, pigtail straightener, flap protector, nasal transfer tube, and drainage connecting tube.

(b) *Classification.* Class I (general controls). The device is exempt from the premarket notification procedures in subpart E of part 807 of this chapter subject to the limitations in § 876.9.

[84 FR 14870, Apr. 12, 2019]

#### § 876.5015 Pancreatic drainage stent and delivery system.

(a) *Identification.* A pancreatic drainage stent is a prescription device that consists of a self-expanding, covered, metallic stent, intended for placement to facilitate transmural endoscopic drainage of pancreatic pseudocysts. This stent is intended to be removed upon confirmation of pseudocyst resolution. This device may also include a delivery system.

(b) *Classification.* Class II (special controls). The special controls for this device are:

(1) The device and elements of the delivery device that may contact the patient must be demonstrated to be biocompatible.

(2) Performance data must demonstrate the sterility of patient-contacting components of the device.

(3) Performance data must support the shelf life of the device by demonstrating continued sterility, package integrity, and device functionality over the requested shelf life.

(4) Non-clinical testing data must demonstrate that the stent and delivery system perform as intended under anticipated conditions of use. The following performance characteristics must be tested:

(i) Deployment testing of the stent and delivery system must be conducted under simulated use conditions.

(ii) Removal force testing must be conducted. The removal force testing must demonstrate that the stent can be safely removed, and that the stent

## § 876.5020

will remain in place when subjected to forces encountered during use.

(iii) Expansion force testing must be conducted. The expansion force must demonstrate that the forces exerted by the stent will not damage the tissue surrounding the stent.

(iv) Compression force testing must be conducted. The compression force must demonstrate that the stent will withstand the forces encountered during use.

(v) Dimensional verification testing must be conducted.

(vi) Tensile testing of joints and materials must be conducted. The minimum acceptance criteria must be adequate for its intended use.

(vii) Fatigue testing must be conducted. Material strength must demonstrate that the stent will withstand forces encountered during use.

(viii) Corrosion testing must be conducted. Corrosion resistance must demonstrate that the stent will withstand conditions encountered during use.

(5) Non-clinical testing must evaluate the compatibility of the stent in a magnetic resonance (MR) environment.

(6) Well-documented clinical experience must demonstrate safe and effective use, and capture any adverse events observed during clinical use.

(7) Labeling must include the following:

(i) Appropriate instructions, warnings, cautions, limitations, and information related to the safe use of the device, including deployment of the device, maintenance of the drainage lumen, and removal of the device.

(ii) A warning that the safety and patency of the stent has not been established beyond the duration of the documented clinical experience.

(iii) Specific instructions and the qualifications and clinical training needed for the safe use of the device, including deployment of the device, maintenance of the drainage lumen, and removal of the device.

(iv) Information on the patient population for which the device has been demonstrated to be effective.

(v) A detailed summary of the clinical experience pertinent to use of the device.

(vi) A detailed summary of the device technical parameters.

## 21 CFR Ch. I (4–1–20 Edition)

(vii) A detailed summary of the device- and procedure-related complications pertinent to use of the device.

(viii) An expiration date/shelf life.

[79 FR 30724, May 29, 2014]

### § 876.5020 External penile rigidity devices.

(a) *Identification.* External penile rigidity devices are devices intended to create or maintain sufficient penile rigidity for sexual intercourse. External penile rigidity devices include vacuum pumps, constriction rings, and penile splints which are mechanical, powered, or pneumatic devices.

(b) *Classification.* Class II (special controls). The devices are exempt from the premarket notification procedures in subpart E of part 807 of this chapter subject to the limitations in § 876.9. The special control for these devices is the FDA guidance document entitled “Class II Special Controls Guidance Document: External Penile Rigidity Devices.” See § 876.1(e) for the availability of this guidance document.

[69 FR 77623, Dec. 23, 2004]

### § 876.5025 Vibrator for climax control of premature ejaculation.

(a) *Identification.* A vibrator for climax control of premature ejaculation is used for males who suffer from premature ejaculation. It is designed to increase the time between arousal and ejaculation using the stimulating vibratory effects of the device on the penis.

(b) *Classification.* Class II (special controls). The device is exempt from the premarket notification procedures in subpart E of part 807 of this chapter subject to the limitations in § 876.9. The special controls for this device are:

(1) The labeling must include specific instructions regarding the proper placement and use of the device.

(2) The portions of the device that contact the patient must be demonstrated to be biocompatible.

(3) Appropriate analysis/testing must demonstrate electromagnetic compatibility safety, electrical safety, and thermal safety of the device.

(4) Mechanical safety testing must demonstrate that the device will withstand forces encountered during use.

[80 FR 30355, May 28, 2015, as amended at 84 FR 71814, Dec. 30, 2019]

**§ 876.5030 Continent ileostomy catheter.**

(a) *Identification.* A continent ileostomy catheter is a flexible tubular device used as a form during surgery for continent ileostomy and it provides drainage after surgery. Additionally, the device may be inserted periodically by the patient for routine care to empty the ileal pouch. This generic type of device includes the rectal catheter for continent ileostomy.

(b) *Classification.* Class I (general controls). The device is exempt from the premarket notification procedures in subpart E of part 807 of this chapter subject to the limitations in § 876.9.

[48 FR 53023, Nov. 23, 1983, as amended at 54 FR 25050, June 12, 1989; 66 FR 38801, July 25, 2001]

**§ 876.5090 Suprapubic urological catheter and accessories.**

(a) *Identification.* A suprapubic urological catheter and accessories is a flexible tubular device that is inserted through the abdominal wall into the urinary bladder with the aid of a trocar and cannula. The device is used to pass fluids to and from the urinary tract. This generic type of device includes the suprapubic catheter and tube, Malecot catheter, catheter punch instrument, suprapubic drainage tube, and the suprapubic cannula and trocar.

(b) *Classification.* (1) Class II (performance standards).

(2) Class I for the catheter punch instrument, nondisposable cannula and trocar, and gastro-urological trocar. The devices subject to this paragraph (b)(2) are exempt from the premarket notification procedures in subpart E of part 807 of this chapter subject to the limitations in § 876.9.

[48 FR 53023, Nov. 23, 1983, as amended at 61 FR 1122, Jan. 16, 1996; 66 FR 38801, July 25, 2001]

**§ 876.5100 Suprapubic catheter accessories.**

(a) *Identification.* Suprapubic catheter accessories are manual devices that are used to facilitate the placement of a suprapubic catheter. This generic type of device includes the introducer, access dilator, and peel-away sheath.

(b) *Classification.* Class I (general controls). The device is exempt from the premarket notification procedures in subpart E of part 807 of this chapter subject to the limitations in § 876.9.

[84 FR 14870, Apr. 12, 2019]

**§ 876.5130 Urological catheter and accessories.**

(a) *Identification.* A urological catheter and accessories is a flexible tubular device that is inserted through the urethra and used to pass fluids to or from the urinary tract. This generic type of device includes radiopaque urological catheters, ureteral catheters, urethral catheters, coudé catheters, balloon retention type catheters, straight catheters, upper urinary tract catheters, double lumen female urethrographic catheters, disposable ureteral catheters, male urethrographic catheters, and urological catheter accessories including ureteral catheter stylets, ureteral catheter adapters, ureteral catheter holders, ureteral catheter stylets, ureteral catheterization trays, and the gastro-urological irrigation tray (for urological use).

(b) *Classification.* (1) Class II (performance standards).

(2) Class I for the ureteral stylet (guidewire), stylet for gastrourological catheter, ureteral catheter adapter, ureteral catheter connector, and ureteral catheter holder. The devices subject to this paragraph (b)(2) are exempt from the premarket notification procedures in subpart E of part 807 of this chapter subject to the limitations in § 876.9.

[48 FR 53023, Nov. 23, 1983, as amended at 61 FR 1122, Jan. 16, 1996; 66 FR 38801, July 25, 2001]

**§ 876.5140 Urethral insert with pump for bladder drainage.**

(a) *Identification.* A urethral insert with pump for bladder drainage is a

catheter-like device with internal pump mechanism that is placed in the urethra. Under patient control the internal pump draws urine out of the bladder when voiding is desired, and blocks urine flow when continence is desired. The device is intended for use by women who cannot empty their bladder due to impaired detrusor contractility.

(b) *Classification*. Class II (special controls). The special controls for this device are:

(1) The elements of the device that may contact the urinary tract must be demonstrated to be biocompatible.

(2) Performance data must demonstrate the sterility of the device components that contact the urinary tract.

(3) Performance data must support shelf life by demonstrating continued sterility of the device (or the sterile components), package integrity, and device functionality over the requested shelf life.

(4) Non-clinical testing data must demonstrate that the device performs as intended under anticipated conditions of use. The following performance characteristics must be tested:

- (i) Urine flow rate testing.
- (ii) Valve integrity testing.
- (iii) Bladder neck retention force testing.
- (iv) Pump/valve endurance testing.
- (v) Encrustation testing.
- (vi) Remote control reliability, mechanical integrity, and battery life testing.

(5) Clinical testing must demonstrate safe and effective use, document the device acceptance rate and the adverse event profile associated with clinical use, and demonstrate that the device performs as intended under anticipated conditions of use.

(6) Labeling must include:

- (i) Specific instructions, contraindications, warnings, cautions, limitations, and the clinical training needed for the safe use of the device.
- (ii) Statement of the maximum insert indwelling period.
- (iii) Information on the patient education and support program prior to and during initial device use.

(iv) Information on the patient population for which the device has been demonstrated to be safe and effective.

(v) Information on how the device operates and the recommended treatment regimen.

(vi) A detailed summary of the device- and procedure-related complications or adverse events pertinent to use of the device.

(vii) An expiration date/shelf life.

(7) Patient labeling must be provided and must include:

(i) Relevant contraindications, warnings, precautions, and adverse events/complications.

(ii) Information on how the device operates and the recommended treatment regimen.

(iii) Information on the patient education and support program prior to and during initial device use.

(iv) Information on the patient population for which there is clinical evidence of safety and effectiveness.

(v) The potential risks and benefits associated with the use of the device.

(vi) Post-insertion care instructions.

(vii) Alternative treatments.

[80 FR 18309, Apr. 6, 2015]

#### § 876.5160 Urological clamp.

(a) *Identification*. A urological clamp for males is a device used to close the urethra of a male to control urinary incontinence or to hold anesthetic or radiography contrast media in the urethra temporarily. It is an external clamp.

(b) *Classification*. Class I (general controls). Except when intended for internal use, the device is exempt from the premarket notification procedures in subpart E of part 807 of this chapter subject to the limitations in § 876.9.

[48 FR 53023, Nov. 23, 1963, as amended at 65 FR 2317, Jan. 14, 2000; 84 FR 71814, Dec. 30, 2019]

#### § 876.5210 Enema kit.

(a) *Identification*. An enema kit is a device intended to instill water or other fluids into the colon through a nozzle inserted into the rectum to promote evacuation of the contents of the lower colon. The device consists of a container for fluid connected to the nozzle either directly or via tubing.

This device does not include the colonic irrigation system (§876.5220).

(b) *Classification.* Class I (general controls). The device is exempt from the premarket notification procedures in subpart E of part 807 of this chapter subject to §876.9. The device is exempt from the current good manufacturing practice requirements of the quality system regulation in part 820 of this chapter, with the exception of §820.180 of this chapter, with respect to general requirements concerning records, and §820.198 of this chapter, with respect to complaint files.

[48 FR 53023, Nov. 23, 1963, as amended at 65 FR 2317, Jan. 14, 2000]

#### § 876.5220 Colonic irrigation system.

(a) *Identification.* A colonic irrigation system is a device intended to instill water into the colon through a nozzle inserted into the rectum to cleanse (evacuate) the contents of the lower colon. The system is designed to allow evacuation of the contents of the colon during the administration of the colonic irrigation. The device consists of a container for fluid connected to the nozzle via tubing and includes a system which enables the pressure, temperature, or flow of water through the nozzle to be controlled. The device may include a console-type toilet and necessary fittings to allow the device to be connected to water and sewer pipes. The device may use electrical power to heat the water. The device does not include the enema kit (§876.5210).

(b) *Classification.* (1) Class II (performance standards) when the device is intended for colon cleansing when medically indicated, such as before radiological or endoscopic examinations.

(2) Class III (premarket approval) when the device is intended for other uses, including colon cleansing routinely for general well being.

(c) *Date PMA or notice of completion of a PDP is required.* A PMA or a notice of completion of a PDP is required to be filed with the Food and Drug Administration on or before December 26, 1996 for any colonic irrigation system described in paragraph (b)(2) of this section that was in commercial distribution before May 28, 1976, or that has, on or before December 26, 1996 been found to be substantially equivalent to a co-

lonic irrigation system described in paragraph (b)(2) of this section that was in commercial distribution before May 28, 1976. Any other colonic irrigation system shall have an approved PMA in effect before being placed in commercial distribution.

[48 FR 53023, Nov. 23, 1983, as amended at 52 FR 17738, May 11, 1987; 61 FR 50707, Sept. 27, 1996]

#### § 876.5250 Urine collector and accessories.

(a) *Identification.* A urine collector and accessories is a device intended to collect urine. The device and accessories consist of tubing, a suitable receptacle, connectors, mechanical supports, and may include a means to prevent the backflow of urine or ascent of infection. The two kinds of urine collectors are:

(1) A urine collector and accessories intended to be connected to an indwelling catheter, which includes the urinary drainage collection kit and the closed urine drainage system and drainage bag; and

(2) A urine collector and accessories not intended to be connected to an indwelling catheter, which includes the corrugated rubber sheath, pediatric urine collector, leg bag for external use, urosheath type incontinence device, and the paste-on device for incontinence.

(b) *Classification*—(1) *Class II (special controls) for a urine collector and accessories intended to be connected to an indwelling catheter.* The device is exempt from the premarket notification procedures in subpart E of part 807 of this chapter subject to §876.9.

(2) *Class I (general controls).* For a urine collector and accessories not intended to be connected to an indwelling catheter, the device is exempt from the premarket notification procedures in subpart E of part 807 of this chapter subject to the limitations in §876.9. If the device is not labeled or otherwise represented as sterile, it is exempt from the current good manufacturing practice requirements of the quality system regulation in part 820 of this chapter, with the exception of §820.180, with respect to general requirements

## § 876.5270

concerning records, and § 820.198, with respect to complaint files.

[48 FR 53023, Nov. 23, 1983, as amended at 63 FR 59228, Nov. 3, 1998; 65 FR 2317, Jan. 14, 2000; 66 FR 38802, July 25, 2001; 73 FR 34860, June 19, 2008]

### § 876.5270 Implanted electrical urinary continence device.

(a) *Identification.* An implanted electrical urinary device is a device intended for treatment of urinary incontinence that consists of a receiver implanted in the abdomen with electrodes for pulsed-stimulation that are implanted either in the bladder wall or in the pelvic floor, and a battery-powered transmitter outside the body.

(b) *Classification.* Class III (premarket approval).

(c) *Date PMA or notice of completion of a PDP is required.* A PMA or a notice of completion of a PDP is required to be filed with the Food and Drug Administration on or before December 26, 1996 for any implanted electrical urinary continence device that was in commercial distribution before May 28, 1976, or that has, on or before December 26, 1996 been found to be substantially equivalent to an implanted electrical urinary continence device that was in commercial distribution before May 28, 1976. Any other implanted electrical urinary continence device shall have an approved PMA or a declared completed PDP in effect before being placed in commercial distribution.

[48 FR 53023, Nov. 23, 1983, as amended at 52 FR 17738, May 11, 1987; 61 FR 50707, Sept. 27, 1996]

### § 876.5280 Implanted mechanical/hydraulic urinary continence device.

(a) *Identification.* An implanted mechanical/hydraulic urinary continence device is a device used to treat urinary incontinence by the application of continuous or intermittent pressure to occlude the urethra. The totally implanted device may consist of a static pressure pad, or a system with a container of radiopaque fluid in the abdomen and a manual pump and valve under the skin surface that is connected by tubing to an adjustable pressure pad or to a cuff around the urethra. The fluid is pumped as needed

## 21 CFR Ch. I (4–1–20 Edition)

from the container to inflate the pad or cuff to pass on the urethra.

(b) *Classification.* Class III (premarket approval).

(c) *Date PMA or notice of completion of a PDP is required.* A PMA or a notice of completion of a PDP is required to be filed with the Food and Drug Administration on or before December 26, 2000, for any implanted mechanical/hydraulic urinary continence device that was in commercial distribution before May 28, 1976, or that has, on or before December 26, 2000, been found to be substantially equivalent to an implanted mechanical/hydraulic urinary continence device that was in commercial distribution before May 28, 1976. Any other implanted mechanical/hydraulic urinary continence device shall have an approved PMA or a declared completed PDP in effect before being placed in commercial distribution.

[48 FR 53023, Nov. 23, 1983, as amended at 52 FR 17738, May 11, 1987; 65 FR 57731, Sept. 26, 2000]

### § 876.5290 Implanted mechanical/hydraulic urinary continence device surgical accessories.

(a) *Identification.* Implanted mechanical/hydraulic urinary continence device surgical accessories are manual devices designed to be used for surgical procedures associated with the implantation of an implanted mechanical/hydraulic urinary continence device. This generic type of device includes the measurement tool or tape, connector assembly tool, tubing plug, incision closing tool, tubing passer, blunt needle, and hemostat shod tubing.

(b) *Classification.* Class I (general controls). The device is exempt from the premarket notification procedures in subpart E of part 807 of this chapter subject to the limitations in § 876.9.

[84 FR 14870, Apr. 12, 2019]

### § 876.5310 Nonimplanted, peripheral electrical continence device.

(a) *Identification.* A nonimplanted, peripheral electrical continence device is a device that consists of an electrode that is connected by an electrical cable to a battery-powered pulse source. The electrode is placed onto or inserted into the body at a peripheral location

**Food and Drug Administration, HHS**

**§ 876.5520**

and used to stimulate the nerves associated with pelvic floor function to maintain urinary continence. When necessary, the electrode may be removed by the user.

(b) *Classification*. Class II, subject to the following special controls:

(1) That sale, distribution, and use of this device are restricted to prescription use in accordance with § 801.109 of this chapter.

(2) That the labeling must bear all information required for the safe and effective use of the device as outlined in § 801.109(c) of this chapter, including a detailed summary of the clinical information upon which the instructions are based.

[65 FR 18237, Apr. 7, 2000]

**§ 876.5320 Nonimplanted electrical continence device.**

(a) *Identification*. A nonimplanted electrical continence device is a device that consists of a pair of electrodes on a plug or a pessary that are connected by an electrical cable to a battery-powered pulse source. The plug or pessary is inserted into the rectum or into the vagina and used to stimulate the muscles of the pelvic floor to maintain urinary or fecal continence. When necessary, the plug or pessary may be removed by the user. This device excludes an AC-powered nonimplanted electrical continence device and the powered vaginal muscle stimulator for therapeutic use (§ 884.5940).

(b) *Classification*. Class II (performance standards).

**§ 876.5365 Esophageal dilator.**

(a) *Identification*. An esophageal dilator is a device that consists of a cylindrical instrument that may be hollow and weighted with mercury or a metal olive-shaped weight that slides on a guide, such as a string or wire and is used to dilate a stricture of the esophagus. This generic type of device includes esophageal or gastrointestinal bougies and the esophageal dilator (metal olive).

(b) *Classification*. Class II (special controls). The device is exempt from the premarket notification procedures

in subpart E of part 807 of this chapter subject to the limitations in § 876.9.

[48 FR 53023, Nov. 23, 1983, as amended at 84 FR 71814, Dec. 30, 2019]

**§ 876.5450 Rectal dilator.**

(a) *Identification*. A rectal dilator is a device designed to dilate the anal sphincter and canal when the size of the anal opening may interfere with its function or the passage of an examining instrument.

(b) *Classification*. Class I (general controls). The device is exempt from the premarket notification procedures in subpart E of part 807 of this chapter subject to the limitations in § 876.9.

[48 FR 53023, Nov. 23, 1983, as amended at 61 FR 1122, Jan. 16, 1996; 66 FR 38802, July 25, 2001]

**§ 876.5470 Ureteral dilator.**

(a) *Identification*. A ureteral dilator is a device that consists of a specially shaped catheter or bougie and is used to dilate the ureter at the place where a stone has become lodged or to dilate a ureteral stricture.

(b) *Classification*. Class II (performance standards).

**§ 876.5520 Urethral dilator.**

(a) *Identification*. A urethral dilator is a device that consists of a slender hollow or solid instrument made of metal, plastic, or other suitable material in a cylindrical form and in a range of sizes and flexibilities. The device may include a mechanism to expand the portion of the device in the urethra and indicate the degree of expansion on a dial. It is used to dilate the urethra. This generic type of device includes the mechanical urethral dilator, urological bougies, metal or plastic urethral sound, urethrometer, filiform, and filiform follower.

(b) *Classification*. (1) Class II (special controls). Except when it is a mechanical urethral dilator, the device is exempt from the premarket notification procedures in subpart E of part 807 of this chapter subject to the limitations in § 876.9.

(2) Class I for the urethrometer, urological bougie, filiform and filiform follower, and metal or plastic urethral

**§ 876.5530**

**21 CFR Ch. I (4–1–20 Edition)**

sound. The devices subject to this paragraph (b)(2) are exempt from the pre-market notification procedures in subpart E of part 807 of this chapter subject to the limitations in § 876.9.

[48 FR 53023, Nov. 23, 1983, as amended at 61 FR 1122, Jan. 16, 1996; 66 FR 38802, July 25, 2001; 84 FR 71814, Dec. 30, 2019]

**§ 876.5530 Implantable transprostatic tissue retractor system.**

(a) *Identification.* An implantable transprostatic tissue retractor system is a prescription use device that consists of a delivery device and implant. The delivery device is inserted transurethrally and deploys the implant through the prostate. It is designed to increase prostatic urethral patency by providing prostate lobe tissue retraction while preserving the potential for future prostate procedures and is intended for the treatment of symptoms due to urinary outflow obstruction secondary to benign prostatic hyperplasia in men.

(b) *Classification.* Class II (special controls). The special controls for this device are:

(1) The elements of the device that may contact the patient must be demonstrated to be biocompatible.

(2) Performance data must demonstrate the sterility of the patient-contacting components of the device.

(3) Performance data must support shelf life by demonstrating continued sterility of the device (of the patient-contacting components), package integrity, and device functionality over the requested shelf life.

(4) Non-clinical testing data must demonstrate that the device performs as intended under anticipated conditions of use. The following performance characteristics must be tested:

(i) Deployment testing must be conducted.

(ii) Mechanical strength must be conducted.

(iii) Resistance-to-degradation testing must be conducted.

(5) Non-clinical testing must evaluate the compatibility of the device in a magnetic resonance environment.

(6) In vivo testing must demonstrate safe and effective use, assess the impact of the implants on the ability to perform subsequent treatments, docu-

ment the adverse event profile associated with clinical use, and demonstrate that the device performs as intended under anticipated conditions of use. The following performance characteristics must be tested:

(i) Deployment testing must be conducted.

(ii) Implant migration must be conducted.

(7) Labeling must bear all information required for safe and effective use of the device, and must include:

(i) Specific instructions, warnings, cautions, limitations, and the clinical training needed for the safe use of the device.

(ii) Information on the patient population for which the device has been demonstrated to be effective.

(iii) A detailed summary of the device technical parameters.

(iv) Information on how the device operates and the typical course of treatment.

(v) An expiration date/shelf life.

(vi) A detailed summary of the device- and procedure-related complications or adverse events pertinent to use of the device.

[79 FR 43249, July 25, 2014]

**§ 876.5540 Blood access device and accessories.**

(a) *Identification.* A blood access device and accessories is a device intended to provide access to a patient's blood for hemodialysis or other chronic uses. When used in hemodialysis, it is part of an artificial kidney system for the treatment of patients with renal failure or toxemic conditions and provides access to a patient's blood for hemodialysis. The device includes implanted blood access devices, non-implanted blood access devices, and accessories for both the implanted and nonimplanted blood access devices.

(1) The implanted blood access device is a prescription device and consists of various flexible or rigid tubes, such as catheters, or cannulae, which are surgically implanted in appropriate blood vessels, may come through the skin, and are intended to remain in the body for 30 days or more. This generic type of device includes various catheters,



shunts, and connectors specifically designed to provide access to blood. Examples include single and double lumen catheters with cuff(s), fully subcutaneous port-catheter systems, and A-V shunt cannulae (with vessel tips). The implanted blood access device may also contain coatings or additives which may provide additional functionality to the device.

(2) The nonimplanted blood access device consists of various flexible or rigid tubes, such as catheters, cannulae or hollow needles, which are inserted into appropriate blood vessels or a vascular graft prosthesis (§§ 870.3450 and 870.3460), and are intended to remain in the body for less than 30 days. This generic type of device includes fistula needles, the single needle dialysis set (coaxial flow needle), and the single needle dialysis set (alternating flow needle).

(3) Accessories common to either type include the shunt adaptor, cannula clamp, shunt connector, shunt stabilizer, vessel dilator, disconnect forceps, shunt guard, crimp plier, tube plier, crimp ring, joint ring, fistula adaptor, and declotting tray (including contents).

(b) *Classification.* (1) Class II (special controls) for the implanted blood access device. The special controls for this device are:

(i) Components of the device that come into human contact must be demonstrated to be biocompatible. Material names and specific designation numbers must be provided.

(ii) Performance data must demonstrate that the device performs as intended under anticipated conditions of use. The following performance characteristics must be tested:

(A) Pressure versus flow rates for both arterial and venous lumens, from the minimum flow rate to the maximum flow rate in 100 milliliter per minute increments, must be established. The fluid and its viscosity used during testing must be stated.

(B) Recirculation rates for both forward and reverse flow configurations must be established, along with the protocol used to perform the assay, which must be provided.

(C) Priming volumes must be established.

(D) Tensile testing of joints and materials must be conducted. The minimum acceptance criteria must be adequate for its intended use.

(E) Air leakage testing and liquid leakage testing must be conducted.

(F) Testing of the repeated clamping of the extensions of the catheter that simulates use over the life of the device must be conducted, and retested for leakage.

(G) Mechanical hemolysis testing must be conducted for new or altered device designs that affect the blood flow pattern.

(H) Chemical tolerance of the device to repeated exposure to commonly used disinfection agents must be established.

(iii) Performance data must demonstrate the sterility of the device.

(iv) Performance data must support the shelf life of the device for continued sterility, package integrity, and functionality over the requested shelf life that must include tensile, repeated clamping, and leakage testing.

(v) Labeling of implanted blood access devices for hemodialysis must include the following:

(A) Labeling must provide arterial and venous pressure versus flow rates, either in tabular or graphical format. The fluid and its viscosity used during testing must be stated.

(B) Labeling must specify the forward and reverse recirculation rates.

(C) Labeling must provide the arterial and venous priming volumes.

(D) Labeling must specify an expiration date.

(E) Labeling must identify any disinfecting agents that cannot be used to clean any components of the device.

(F) Any contraindicated disinfecting agents due to material incompatibility must be identified by printing a warning on the catheter. Alternatively, contraindicated disinfecting agents must be identified by a label affixed to the patient's medical record and with written instructions provided directly to the patient.

(G) Labeling must include a patient implant card.

(H) The labeling must contain comprehensive instructions for the following:

(1) Preparation and insertion of the device, including recommended site of insertion, method of insertion, and a reference on the proper location for tip placement;

(2) Proper care and maintenance of the device and device exit site;

(3) Removal of the device;

(4) Anticoagulation;

(5) Management of obstruction and thrombus formation; and

(6) Qualifications for clinical providers performing the insertion, maintenance, and removal of the devices.

(vi) In addition to Special Controls in paragraphs (b)(1)(i) through (v) of this section, implanted blood access devices that include subcutaneous ports must include the following:

(A) Labeling must include the recommended type of needle for access as well as detailed instructions for care and maintenance of the port, subcutaneous pocket, and skin overlying the port.

(B) Performance testing must include results on repeated use of the ports that simulates use over the intended life of the device.

(C) Clinical performance testing must demonstrate safe and effective use and capture any adverse events observed during clinical use.

(vii) In addition to Special Controls in paragraphs (b)(1)(i) through (v) of this section, implanted blood access devices with coatings or additives must include the following:

(A) A description and material characterization of the coating or additive material, the purpose of the coating or additive, duration of effectiveness, and how and where the coating is applied.

(B) An identification in the labeling of any coatings or additives and a summary of the results of performance testing for any coating or material with special characteristics, such as decreased thrombus formation or antimicrobial properties.

(C) A Warning Statement in the labeling for potential allergic reactions including anaphylaxis if the coating or additive contains known allergens.

(D) Performance data must demonstrate efficacy of the coating or additive and the duration of effectiveness.

(viii) The following must be included for A–V shunt cannulae (with vessel tips):

(A) The device must comply with Special Controls in paragraphs (b)(1)(i) through (v) of this section with the exception of paragraphs (b)(1)(ii)(B), (b)(1)(ii)(C), (b)(1)(v)(B), and (b)(1)(v)(C), which do not apply.

(B) Labeling must include Warning Statements to address the potential for vascular access steal syndrome, arterial stenosis, arterial thrombosis, and hemorrhage including exsanguination given that the device accesses the arterial circulation.

(C) Clinical performance testing must demonstrate safe and effective use and capture any adverse events observed during clinical use.

(2) Class II (performance standards) for the nonimplanted blood access device.

(3) Class II (performance standards) for accessories for both the implanted and the nonimplanted blood access devices not listed in paragraph (b)(4) of this section.

(4) Class I for the cannula clamp, disconnect forceps, crimp plier, tube plier, crimp ring, and joint ring, accessories for both the implanted and nonimplanted blood access device. The devices subject to this paragraph (b)(4) are exempt from the premarket notification procedures in subpart E of part 807 of this chapter subject to the limitations in § 876.9.

[48 FR 53023, Nov. 23, 1983, as amended at 52 FR 17738, May 11, 1987; 61 FR 1122, Jan. 16, 1996; 66 FR 38802, July 25, 2001; 79 FR 43245, July 25, 2014]

**§ 876.5550 Prostatic artery embolization device.**

(a) *Identification.* A prostatic artery embolization device is an intravascular implant intended to occlude the prostatic arteries to prevent blood flow to the targeted area of the prostate, resulting in a reduction of lower urinary tract symptoms related to benign prostatic hyperplasia. This does not include cyanoacrylates and other embolic agents which act by in situ polymerization or precipitation, or embolization devices used in neurovascular applications (see 21 CFR 882.5950).

(b) *Classification.* Class II (special controls). The special controls for this device are:

(1) The device must be demonstrated to be biocompatible.

(2) Non-clinical performance testing must demonstrate that the device performs as intended under anticipated conditions of use. The following performance characteristics must be tested:

(i) Evaluation of suitability for injection through catheters intended for use in embolization; and

(ii) Evaluation of the size distribution of the device.

(3) Performance data must support the sterility and pyrogenicity of the device.

(4) Performance data must support the shelf life of the device by demonstrating continued sterility, package integrity, and device functionality over the identified shelf life.

(5) Clinical data must evaluate post-embolization damage due to non-target embolization under anticipated use conditions.

(6) The labeling must include:

(i) Specific instructions on safe device preparation and use;

(ii) The device shelf life;

(iii) Data regarding urinary retention; and

(iv) Data regarding post-prostatic artery embolization syndrome.

[82 FR 52651, Nov. 14, 2017]

**§ 876.5600 Sorbent regenerated dialysate delivery system for hemodialysis.**

(a) *Identification.* A sorbent regenerated dialysate delivery system for hemodialysis is a device that is part of an artificial kidney system for the treatment of patients with renal failure or toxemic conditions, and that consists of a sorbent cartridge and the means to circulate dialysate through this cartridge and the dialysate compartment of the dialyzer. The device is used with the extracorporeal blood system and the dialyzer of the hemodialysis system and accessories (§ 876.5820). The device includes the means to maintain the temperature, conductivity, electrolyte balance, flow rate and pressure of the dialysate, and alarms to indicate abnormal dialysate

conditions. The sorbent cartridge may include absorbent, ion exchange and catalytic materials.

(b) *Classification.* Class II (performance standards).

**§ 876.5630 Peritoneal dialysis system and accessories.**

(a) *Identification.* (1) A peritoneal dialysis system and accessories is a device that is used as an artificial kidney system for the treatment of patients with renal failure or toxemic conditions, and that consists of a peritoneal access device, an administration set for peritoneal dialysis, a source of dialysate, and, in some cases, a water purification mechanism. After the dialysate is instilled into the patient's peritoneal cavity, it is allowed to dwell there so that undesirable substances from the patient's blood pass through the lining membrane of the peritoneal cavity into this dialysate. These substances are then removed when the dialysate is drained from the patient. The peritoneal dialysis system may regulate and monitor the dialysate temperature, volume, and delivery rate together with the time course of each cycle of filling, dwell time, and draining of the peritoneal cavity or manual controls may be used. This generic device includes the semiautomatic and the automatic peritoneal delivery system.

(2) The peritoneal access device is a flexible tube that is implanted through the abdominal wall into the peritoneal cavity and that may have attached cuffs to provide anchoring and a skin seal. The device is either a single use peritoneal catheter, intended to remain in the peritoneal cavity for less than 30 days, or a long term peritoneal catheter. Accessories include stylets and trocars to aid in the insertion of the catheter and an obturator to maintain the patency of the surgical fistula in the abdominal wall between treatments.

(3) The disposable administration set for peritoneal dialysis consists of tubing, an optional reservoir bag, and appropriate connectors. It may include a peritoneal dialysate filter to trap and remove contaminating particles.

(4) The source of dialysate may be sterile prepackaged dialysate (for semi-automatic peritoneal dialysate delivery systems or “cyclers systems”) or dialysate prepared from dialysate concentrate and sterile purified water (for automatic peritoneal dialysate delivery systems or “reverse osmosis” systems). Prepackaged dialysate intended for use with either of the peritoneal dialysate delivery systems is regulated by FDA as a drug.

(b) *Classification.* Class II (special controls). The following accessories are exempt from the premarket notification procedures in subpart E of part 807 of this chapter subject to the limitations in § 876.9: A catheter finger grip that is non-patient contacting and intended for single use with a peritoneal catheter; a continuous ambulatory peritoneal dialysis (CAPD) belt; and a catheter stand that does not include weigh scales.

[48 FR 53023, Nov. 23, 1983, as amended at 84 FR 71814, Dec. 30, 2019]

**§ 876.5665 Water purification system for hemodialysis.**

(a) *Identification.* A water purification system for hemodialysis is a device that is intended for use with a hemodialysis system and that is intended to remove organic and inorganic substances and microbial contaminants from water used to dilute dialysate concentrate to form dialysate. This generic type of device may include a water softener, sediment filter, carbon filter, and water distillation system.

(b) *Classification.* Class II (special controls). The device, when it is a water purification subsystem disinfectant, is exempt from the premarket notification procedures in subpart E of part 807 of this chapter subject to the limitations in § 876.9.

[48 FR 53023, Nov. 23, 1983, as amended at 84 FR 71814, Dec. 30, 2019]

**§ 876.5820 Hemodialysis system and accessories.**

(a) *Identification.* A hemodialysis system and accessories is a device that is used as an artificial kidney system for the treatment of patients with renal failure or toxic conditions and that consists of an extracorporeal blood system, a conventional dialyzer, a

dialysate delivery system, and accessories. Blood from a patient flows through the tubing of the extracorporeal blood system and accessories to the blood compartment of the dialyzer, then returns through further tubing of the extracorporeal blood system to the patient. The dialyzer has two compartments that are separated by a semipermeable membrane. While the blood is in the blood compartment, undesirable substances in the blood pass through the semipermeable membrane into the dialysate in the dialysate compartment. The dialysate delivery system controls and monitors the dialysate circulating through the dialysate compartment of the dialyzer.

(1) The extracorporeal blood system and accessories consists of tubing, pumps, pressure monitors, air foam or bubble detectors, and alarms to keep blood moving safely from the blood access device and accessories for hemodialysis (§ 876.5540) to the blood compartment of the dialyzer and back to the patient.

(2) The conventional dialyzer allows a transfer of water and solutes between the blood and the dialysate through the semipermeable membrane. The semipermeable membrane of the conventional dialyzer has a sufficiently low permeability to water that an ultrafiltration controller is not required to prevent excessive loss of water from the patient's blood. This conventional dialyzer does not include hemodialyzers with the disposable inserts (Kiil type) (§ 876.5830) or dialyzers of high permeability (§ 876.5860).

(3) The dialysate delivery system consists of mechanisms that monitor and control the temperature, conductivity, flow rate, and pressure of the dialysate and circulates dialysate through the dialysate compartment of the dialyzer. The dialysate delivery system includes the dialysate concentrate for hemodialysis (liquid or powder) and alarms to indicate abnormal dialysate conditions. This dialysate delivery system does not include the sorbent regenerated dialysate delivery system for hemodialysis (§ 876.5600), the dialysate delivery system of the peritoneal dialysis system and accessories (§ 876.5630), or the controlled dialysate delivery system of the

high permeability hemodialysis system (§876.5860).

(4) Remote accessories to the hemodialysis system include the unpowered dialysis chair without a scale, the powered dialysis chair without a scale, the dialyzer holder set, dialysis tie gun and ties, and hemodialysis start/stop tray.

(b) *Classification.* (1) Class II (performance standards) for hemodialysis systems and all accessories directly associated with the extracorporeal blood system and the dialysate delivery system.

(2) Class I for other accessories of the hemodialysis system remote from the extracorporeal blood system and the dialysate delivery system, such as the unpowered dialysis chair, hemodialysis start/stop tray, dialyzer holder set, and dialysis tie gun and ties. The devices subject to this paragraph (b)(2) are exempt from the premarket notification procedures in subpart E of part 807 of this chapter subject to the limitations in §876.9.

[48 FR 53023, Nov. 23, 1983, as amended at 54 FR 25050, June 12, 1989; 66 FR 38802, July 25, 2001]

**§ 876.5830 Hemodialyzer with disposable insert (Kiil type).**

(a) *Identification.* A hemodialyzer with disposable inserts (Kiil type) is a device that is used as a part of an artificial kidney system for the treatment of patients with renal failure or toxic conditions and that includes disposable inserts consisting of layers of semipermeable membranes which are sandwiched between support plates. The device is used with the extracorporeal blood system and the dialysate delivery system of the hemodialysis system and accessories (§876.5820).

(b) *Classification.* Class II (performance standards).

[48 FR 53023, Nov. 23, 1983, as amended at 53 FR 11253, Apr. 6, 1988]

**§ 876.5860 High permeability hemodialysis system.**

(a) *Identification.* A high permeability hemodialysis system is a device intended for use as an artificial kidney system for the treatment of patients with renal failure, fluid overload, or toxic conditions by performing such

therapies as hemodialysis, hemofiltration, hemoconcentration, and hemodiafiltration. Using a hemodialyzer with a semipermeable membrane that is more permeable to water than the semipermeable membrane of the conventional hemodialysis system (§876.5820), the high permeability hemodialysis system removes toxins or excess fluid from the patient's blood using the principles of convection (via a high ultrafiltration rate) and/or diffusion (via a concentration gradient in dialysate). During treatment, blood is circulated from the patient through the hemodialyzer's blood compartment, while the dialysate solution flows countercurrent through the dialysate compartment. In this process, toxins and/or fluid are transferred across the membrane from the blood to the dialysate compartment. The hemodialysis delivery machine controls and monitors the parameters related to this processing, including the rate at which blood and dialysate are pumped through the system, and the rate at which fluid is removed from the patient. The high permeability hemodialysis system consists of the following devices:

(1) The hemodialyzer consists of a semipermeable membrane with an *in vitro* ultrafiltration coefficient ( $K_{uf}$ ) greater than 8 milliliters per hour per conventional millimeter of mercury, as measured with bovine or expired human blood, and is used with either an automated ultrafiltration controller or another method of ultrafiltration control to prevent fluid imbalance.

(2) The hemodialysis delivery machine is similar to the extracorporeal blood system and dialysate delivery system of the hemodialysis system and accessories (§876.5820), with the addition of an ultrafiltration controller and mechanisms that monitor and/or control such parameters as fluid balance, dialysate composition, and patient treatment parameters (e.g., blood pressure, hematocrit, urea, etc.).

(3) The high permeability hemodialysis system accessories include, but are not limited to, tubing lines and various treatment related monitors (e.g., dialysate pH, blood pressure, hematocrit, and blood recirculation monitors).

**§ 876.5870**

**21 CFR Ch. I (4–1–20 Edition)**

(b) *Classification.* Class II. The special controls for this device are FDA's:

(1) "Use of International Standard ISO 10993 'Biological Evaluation of Medical Device—Part I: Evaluation and Testing,'" "

(2) "Guidance for the Content of 510(k)s for Conventional and High Permeability Hemodialyzers," "

(3) "Guidance for Industry and CDRH Reviewers on the Content of Pre-market Notifications for Hemodialysis Delivery Systems," "

(4) "Guidance for the Content of Pre-market Notifications for Water Purification Components and Systems for Hemodialysis," and

(5) "Guidance for Hemodialyzer Reuse Labeling."

[65 FR 17145, Mar. 31, 2000]

**§ 876.5870 Sorbent hemoperfusion system.**

(a) *Identification.* A sorbent hemoperfusion system is a prescription device that consists of an extracorporeal blood system similar to that identified in the hemodialysis system and accessories (§876.5820) and a container filled with adsorbent material that removes a wide range of substances, both toxic and normal, from blood flowing through it. The adsorbent materials are usually activated-carbon or resins which may be coated or immobilized to prevent fine particles entering the patient's blood. The generic type of device may include lines and filters specifically designed to connect the device to the extracorporeal blood system. The device is used in the treatment of poisoning, drug overdose, hepatic coma, or metabolic disturbances.

(b) *Classification.* (1) Class II (special controls) when the device is intended for the treatment of poisoning and drug overdose. The special controls for this device are:

(i) The device must be demonstrated to be biocompatible;

(ii) Performance data must demonstrate the mechanical integrity of the device (e.g., tensile, flexural, and structural strength), including testing for the possibility of leaks, ruptures, release of particles, and/or disconnections under anticipated conditions of use;

(iii) Performance data must demonstrate device sterility and shelf life;

(iv) Bench performance testing must demonstrate device functionality in terms of substances, toxins, and drugs removed by the device, and the extent that these are removed when the device is used according to its labeling, and to validate the device's safeguards;

(v) A summary of clinical experience with the device that discusses and analyzes device safety and performance, including a list of adverse events observed during the testing, must be provided;

(vi) Labeling must include the following:

(A) A detailed summary of the device-related and procedure-related complications pertinent to the use of the device;

(B) A summary of the performance data provided for the device, including a list of the drugs and/or poisons the device has been demonstrated to remove, and the extent for removal/depletion; and

(vii) For those devices that incorporate electrical components, appropriate analysis and testing must be conducted to verify electrical safety and electromagnetic compatibility of the device.

(2) Class III (premarket approval) when the device is intended for the treatment of hepatic coma and metabolic disturbances.

(c) *Date premarket approval application (PMA) or notice of completion of product development protocol (PDP) is required.* A PMA or notice of completion of a PDP is required to be filed with FDA by April 17, 2014, for any sorbent hemoperfusion system indicated for treatment of hepatic coma or metabolic disturbances that was in commercial distribution before May 28, 1976, or that has, by April 17, 2014, been found to be substantially equivalent to any sorbent hemoperfusion device indicated for treatment of hepatic coma or metabolic disturbances that was in commercial distribution before May 28, 1976. Any other sorbent hemoperfusion system device indicated for treatment of hepatic coma or metabolic disturbances shall have an approved PMA or

## Food and Drug Administration, HHS

## § 876.5920

declared completed PDP in effect before being placed in commercial distribution.

[79 FR 3094, Jan. 17, 2014]

### § 876.5880 Isolated kidney perfusion and transport system and accessories.

(a) *Identification.* An isolated kidney perfusion and transport system and accessories is a device that is used to support a donated or a cadaver kidney and to maintain the organ in a near-normal physiologic state until it is transplanted into a recipient patient. This generic type of device may include tubing, catheters, connectors, an ice storage or freezing container with or without bag or preservatives, pulsatile or nonpulsatile hypothermic isolated organ perfusion apparatus with or without oxygenator, and disposable perfusion set.

(b) *Classification.* Class II (performance standards).

### § 876.5885 Tissue culture media for human ex vivo tissue and cell culture processing applications.

(a) *Identification.* Tissue culture media for human ex vivo tissue and cell culture processing applications consist of cell and tissue culture media and components that are composed of chemically defined components (e.g., amino acids, vitamins, inorganic salts) that are essential for the ex vivo development, survival, and maintenance of tissues and cells of human origin. The solutions are indicated for use in human ex vivo tissue and cell culture processing applications.

(b) *Classification.* Class II (special controls): FDA guidance document, "Class II Special Controls Guidance Document: Tissue Culture Media for Human Ex Vivo Processing Applications; Final Guidance for Industry and FDA Reviewers."

[66 FR 27025, May 16, 2001]

### § 876.5895 Ostomy irrigator.

(a) *Identification.* An ostomy irrigator is a device that consists of a container for fluid, tubing with a cone-shaped tip or a soft and flexible catheter with a retention shield and that is used to wash out the colon through a colos-

tomy, a surgically created opening of the colon on the surface of the body.

(b) *Classification.* Class II (special controls). The device is exempt from the premarket notification procedures in subpart E of part 807 of this chapter subject to the limitations in § 876.9.

[48 FR 53023, Nov. 23, 1983, as amended at 84 FR 71814, Dec. 30, 2019]

### § 876.5900 Ostomy pouch and accessories.

(a) *Identification.* An ostomy pouch and accessories is a device that consists of a bag that is attached to the patient's skin by an adhesive material and that is intended for use as a receptacle for collection of fecal material or urine following an ileostomy, colostomy, or ureterostomy (a surgically created opening of the small intestine, large intestine, or the ureter on the surface of the body). This generic type of device and its accessories includes the ostomy pouch, ostomy adhesive, the disposable colostomy appliance, ostomy collector, colostomy pouch, urinary ileostomy bag, urine collecting ureterostomy bag, ostomy drainage bag with adhesive, stomal bag, ostomy protector, and the ostomy size selector, but excludes ostomy pouches which incorporate arsenic-containing compounds.

(b) *Classification.* Class I (general controls). The device is exempt from the premarket notification procedures in subpart E of part 807 of this chapter subject to the limitations in § 876.9.

[48 FR 53023, Nov. 23, 1983, as amended at 54 FR 25050, June 12, 1989; 66 FR 38802, July 25, 2001]

### § 876.5920 Protective garment for incontinence.

(a) *Identification.* A protective garment for incontinence is a device that consists of absorbent padding and a fluid barrier and that is intended to protect an incontinent patient's garment from the patient's excreta. This generic type of device does not include diapers for infants.

(b) *Classification.* Class I (general controls). The device is exempt from the premarket notification procedures in subpart E of part 807 of this chapter subject to the limitations in § 876.9. The device is also exempt from the current

## § 876.5930

good manufacturing practice requirements of the quality system regulation in part 820 of this chapter, with the exception of § 820.180, regarding general requirements concerning records, and § 820.198, regarding complaint files.

[48 FR 53023, Nov. 23, 1983, as amended at 54 FR 25050, June 12, 1989; 66 FR 38802, July 25, 2001]

### § 876.5930 Rectal control system.

(a) *Identification.* A rectal control system is a prescription device intended to treat fecal incontinence by controlling the size of the rectal lumen. The device is inserted in the vagina and includes a portion that expands to reduce the rectal lumen to prevent stool leakage and retracts to allow normal passage of stool. The device includes an external regulator to control the state of expansion.

(b) *Classification.* Class II (special controls). The special controls for this device are:

(1) Clinical testing must document the device acceptance data and the adverse event profile associated with clinical use, and demonstrate that the device performs as intended under anticipated conditions of use.

(2) The elements of the device that contact vaginal tissue must be demonstrated to be biocompatible.

(3) The cleaning and disinfection instructions for the device must be validated.

(4) Non-clinical (bench) testing must demonstrate that the device performs as intended under anticipated conditions of use.

(5) Non-clinical (bench) testing must demonstrate that the device does not:

(i) Enhance the growth of *Staphylococcus aureus*.

(ii) Increase production of Toxic Shock Syndrome Toxin-1 by *S. aureus*.

(iii) Alter the growth of normal vaginal flora.

(6) Labeling must include:

(i) Specific instructions, contraindications, warnings, cautions, limitations, and the clinical training needed for the safe use of the device.

(ii) The intended patient population and the intended use environment.

(iii) Information on how the device is to be fitted, how the device operates,

## 21 CFR Ch. I (4–1–20 Edition)

and recommendations on device maintenance.

(iv) A detailed summary of the clinical testing pertinent to the use of the device, including a summary of the device- and procedure-related complications or adverse events related to use of the device, as well as relevant safety and performance information.

(7) Patient labeling must be provided and must include:

(i) Relevant contraindications, warnings, precautions, and adverse events/complications.

(ii) Information on how the device operates and the recommended device maintenance (*i.e.*, care instructions), including cleaning and disinfection.

(iii) Information on the patient population for which there was a favorable benefit/risk assessment.

(iv) The potential risks and benefits associated with the use of the device.

[80 FR 30933, June 1, 2015]

### § 876.5955 Peritoneo-venous shunt.

(a) *Identification.* A peritoneo-venous shunt is an implanted device that consists of a catheter and a pressure activated one-way valve. The catheter is implanted with one end in the peritoneal cavity and the other in a large vein. This device enables ascitic fluid in the peritoneal cavity to flow into the venous system for the treatment of intractable ascites.

(b) *Classification.* Class II. The special controls for this device are FDA's:

(1) "Use of International Standard ISO 10993 'Biological Evaluation of Medical Devices—Part I: Evaluation and Testing,'" "

(2) "510(k) Sterility Review Guidance of 2/12/90 (K90-1)," and

(3) Backflow specification and testing to prevent reflux of blood into the shunt.

[48 FR 53023, Nov. 23, 1983, as amended at 52 FR 17738, May 11, 1987; 65 FR 17145, Mar. 31, 2000]

### § 876.5970 Hernia support.

(a) *Identification.* A hernia support is a device, usually made of elastic, canvas, leather, or metal, that is intended to be placed over a hernial opening (a weakness in the abdominal wall) to prevent protrusion of the abdominal



contents. This generic type of device includes the umbilical truss.

(b) *Classification.* Class I (general controls). The device is exempt from the premarket notification procedures in subpart E of part 807 of this chapter subject to the limitations in § 876.9. The device is also exempt from the current good manufacturing practice requirements of the quality system regulation in part 820 of this chapter, with the exception of § 820.180, regarding general requirements concerning records, and § 820.198, regarding complaint files.

[48 FR 53023, Nov. 23, 1983, as amended at 59 FR 63010, Dec. 7, 1994; 66 FR 38802, July 25, 2001]

**§ 876.5980 Gastrointestinal tube and accessories.**

(a) *Identification.* A gastrointestinal tube and accessories is a device that consists of flexible or semi-rigid tubing used for instilling fluids into, withdrawing fluids from, splinting, or suppressing bleeding of the alimentary tract. This device may incorporate an integral inflatable balloon for retention or hemostasis. This generic type of device includes the hemostatic bag, irrigation and aspiration catheter (gastric, colonic, etc.), rectal catheter, sterile infant gavage set, gastrointestinal string and tubes to locate internal bleeding, double lumen tube for intestinal decompression or intubation, feeding tube, gastroenterostomy tube, Levine tube, nasogastric tube, single lumen tube with mercury weight balloon for intestinal intubation or decompression, and gastro-urological irrigation tray (for gastrological use).

(b) *Classification.* (1) Class II (special controls). The barium enema retention catheter and tip with or without a bag that is a gastrointestinal tube and accessory or a gastronomy tube holder accessory is exempt from the premarket notification procedures in subpart E of part 807 of this chapter subject to the limitations in § 876.9.

(2) Class I (general controls) for the dissolvable nasogastric feed tube guide for the nasogastric tube. The class I device is exempt from the premarket notification procedures in subpart E of

part 807 of this chapter subject to § 876.9.

[49 FR 573, Jan. 5, 1984, as amended at 65 FR 2317, Jan. 14, 2000; 65 FR 76932, Dec. 8, 2000; 84 FR 71814, Dec. 30, 2019]

**§ 876.5981 Oral removable palatal space occupying device for weight management and/or weight loss.**

(a) *Identification.* An oral removable palatal space occupying device for weight management and/or weight loss is a prescription device that is worn during meals to limit bite size, thereby reducing the amount of food that is consumed. The device may contain recording sensors for monitoring patient use. This classification does not include devices that are intended to treat any dental diseases or conditions

(b) *Classification.* Class II (special controls). The special controls for this device are:

(1) The patient-contacting components of the device must be demonstrated to be biocompatible for its intended use.

(2) Non-clinical performance testing must demonstrate that the device performs as intended under anticipated conditions for use, as follows:

(i) Mechanical testing must demonstrate that the device performs as intended for the labeled use life and does not create forces that result in movement of teeth and damage to teeth.

(ii) Electrical safety and electromagnetic compatibility testing must demonstrate that the device performs as intended.

(iii) Software verification and validation must demonstrate that the device performs as intended.

(iv) Battery testing must demonstrate that the device battery performs as intended.

(3) Clinical performance testing must demonstrate the device performs as intended and must include an evaluation for choking.

(4) Device labeling must address the following:

(i) Patient labeling must state:

(A) The clinical benefit of weight management and/or weight loss as assessed by using percent total body weight loss;

**§ 876.5985**

**21 CFR Ch. I (4–1–20 Edition)**

(B) Treatment must be offered in combination with a behavioral modification program;

(C) Instructions on how to use the device as intended; and

(D) The use life of the device.

(ii) Physician labeling must state:

(A) The clinical benefit of weight management and/or weight loss as assessed by using percent total body weight loss;

(B) Treatment must be offered in combination with a behavioral modification program;

(C) Instructions on how to use the device as intended; and

(D) The use life of the device.

(5) Training must be provided to health professionals that includes procedures for determining a patient's oral health status, instructions for making the palatal mold, and assessment of issues with the device that may require service by the manufacturer.

[82 FR 35069, July 28, 2017]

**§ 876.5985 Enzyme packed cartridge.**

(a) *Identification.* An enzyme packed cartridge is an *ex vivo* prescription device that is used in enzymatic hydrolysis of macronutrients into their essential nutrient forms at the time of delivery. The device consists of an outer casing containing an inert polymer with a covalently bound enzyme through which nutritional formula is directed. The device fits in line with enteral feeding systems.

(b) *Classification.* Class II (special controls). The special controls for this device are:

(1) The patient contacting components of the device must be demonstrated to be biocompatible.

(2) *In vivo* testing must be performed and must demonstrate that the device causes neither an adverse tissue response nor adverse performance.

(3) Non-clinical testing must demonstrate that the device performs as intended under anticipated conditions of use. The following performance characteristics must be demonstrated:

(i) Mechanical testing to demonstrate that the device can withstand clinical forces;

(ii) Flow rate and leakage testing to demonstrate that the device does not impede the flow of enteral formula;

(iii) Demonstration of enzymatic effect on intended macronutrient;

(iv) The amount of enzyme that exits the cartridge must be characterized;

(v) Validation that the device does not adversely impact the nutritional composition of enteral formula; and

(vi) Validation that the device does not impede flow alarms on enteral feeding pumps.

(4) Human factors testing must be performed to characterize use error risks.

(5) Performance data must support shelf life by demonstrating package integrity and device functionality over the identified shelf life.

(6) Labeling must include the following:

(i) A detailed summary of *in vivo* testing pertinent to use of the device, including device-related adverse events;

(ii) A detailed summary of compatible formulas that is supported by non-clinical testing, including the expected enzymatic conversion as a percentage;

(iii) Detailed instructions on how to place the device into an enteral feeding circuit;

(iv) A warning regarding the possibility for misconnections; and

(v) Expiration date or shelf life.

(7) Patient labeling must be provided and must include:

(i) Relevant warnings, precautions, adverse effects, and complications;

(ii) A description of the device and how it operates;

(iii) Instructions on how to correctly use the device; and

(iv) The benefits and risks associated with the use of the device.

[82 FR 47971, Oct. 16, 2017]

**§ 876.5990 Extracorporeal shock wave lithotripter.**

(a) *Identification.* An extracorporeal shock wave lithotripter is a device that focuses ultrasonic shock waves into the body to noninvasively fragment urinary calculi within the kidney or ureter. The primary components of the device are a shock wave generator, high voltage generator, control console, imaging/localization system, and patient

table. Prior to treatment, the urinary stone is targeted using either an integral or stand-alone localization/imaging system. Shock waves are typically generated using electrostatic spark discharge (spark gap), electromagnetically repelled membranes, or piezoelectric crystal arrays, and focused onto the stone with either a specially designed reflector, dish, or acoustic lens. The shock waves are created under water within the shock wave generator, and are transferred to the patient's body using an appropriate acoustic interface. After the stone has been fragmented by the focused shock waves, the fragments pass out of the body with the patient's urine.

(b) *Classification.* Class II (special controls) (FDA guidance document: "Guidance for the Content of Pre-market Notifications (510(k)'s) for Extracorporeal Shock Wave Lithotripters Indicated for the Fragmentation of Kidney and Ureteral Calculi.")

[65 FR 48612, Aug. 9, 2000]

## PART 878—GENERAL AND PLASTIC SURGERY DEVICES

### Subpart A—General Provisions

Sec.

- 878.1 Scope.
- 878.3 Effective dates of requirement for pre-market approval.
- 878.9 Limitations of exemptions from section 510(k) of the Federal Food, Drug, and Cosmetic Act (the act).

### Subpart B—Diagnostic Devices

- 878.1800 Speculum and accessories.

### Subpart C [Reserved]

### Subpart D—Prosthetic Devices

- 878.3250 External facial fracture fixation appliance.
- 878.3300 Surgical mesh.
- 878.3500 Polytetrafluoroethylene with carbon fibers composite implant material.
- 878.3530 Silicone inflatable breast prosthesis.
- 878.3540 Silicone gel-filled breast prosthesis.
- 878.3550 Chin prosthesis.
- 878.3590 Ear prosthesis.
- 878.3610 Esophageal prosthesis.
- 878.3680 Nose prosthesis.
- 878.3720 Tracheal prosthesis.
- 878.3750 External prosthesis adhesive.

- 878.3800 External aesthetic restoration prosthesis.
- 878.3900 Inflatable extremity splint.
- 878.3910 Noninflatable extremity splint.
- 878.3925 Plastic surgery kit and accessories.

### Subpart E—Surgical Devices

- 878.4010 Tissue adhesive.
- 878.4011 Tissue adhesive with adjunct wound closure device for topical approximation of skin.
- 878.4014 Nonresorbable gauze/sponge for external use.
- 878.4015 Wound dressing with poly (diallyl dimethyl ammonium chloride) (pDADMAC) additive.
- 878.4018 Hydrophilic wound dressing.
- 878.4020 Occlusive wound dressing.
- 878.4022 Hydrogel wound dressing and burn dressing.
- 878.4025 Silicone sheeting.
- 878.4040 Surgical apparel.
- 878.4100 Organ bag.
- 878.4160 Surgical camera and accessories.
- 878.4165 Wound autofluorescence imaging device.
- 878.4200 Introduction/drainage catheter and accessories.
- 878.4300 Implantable clip.
- 878.4320 Removable skin clip.
- 878.4340 Contact cooling system for aesthetic use.
- 878.4350 Cryosurgical unit and accessories.
- 878.4360 Scalp cooling system to reduce the likelihood of chemotherapy-induced alopecia.
- 878.4370 Surgical drape and drape accessories.
- 878.4371 Irrigating wound retractor device.
- 878.4380 Drape adhesive.
- 878.4400 Electrosurgical cutting and coagulation device and accessories.
- 878.4410 Low energy ultrasound wound cleaner.
- 878.4420 Electrosurgical device for over-the-counter aesthetic use.
- 878.4430 Microneedling device for aesthetic use.
- 878.4440 Eye pad.
- 878.4450 Nonabsorbable gauze for internal use.
- 878.4452 Nonabsorbable expandable hemostatic sponge for temporary internal use.
- 878.4454 Non-absorbable, hemostatic gauze for temporary internal use.
- 878.4456 Hemostatic device for intraluminal gastrointestinal use.
- 878.4460 Non-powdered surgeon's glove.
- 878.4470 Surgeon's gloving cream.
- 878.4490 Absorbable hemostatic agent and dressing.
- 878.4493 Absorbable poly(glycolide/l-lactide) surgical suture.
- 878.4494 Absorbable poly(hydroxybutyrate) surgical suture produced by recombinant DNA technology.

## § 878.1

- 878.4495 Stainless steel suture.
- 878.4520 Polytetrafluoroethylene injectable.
- 878.4580 Surgical lamp.
- 878.4590 Focused ultrasound stimulator system for aesthetic use.
- 878.4630 Ultraviolet lamp for dermatologic disorders.
- 878.4635 Sunlamp products and ultraviolet lamps intended for use in sunlamp products.
- 878.4660 Skin marker.
- 878.4670 Internal tissue marker.
- 878.4680 Nonpowered, single patient, portable suction apparatus.
- 878.4683 Non-Powered suction apparatus device intended for negative pressure wound therapy.
- 878.4685 Extracorporeal shock wave device for treatment of chronic wounds.
- 878.4700 Surgical microscope and accessories.
- 878.4730 Surgical skin degreaser or adhesive tape solvent.
- 878.4750 Implantable staple.
- 878.4755 Absorbable lung biopsy plug.
- 878.4760 Removable skin staple.
- 878.4780 Powered suction pump.
- 878.4790 Powered surgical instrument for improvement in the appearance of cellulite.
- 878.4800 Manual surgical instrument for general use.
- 878.4810 Laser surgical instrument for use in general and plastic surgery and in dermatology.
- 878.4815 Magnetic surgical instrument system.
- 878.4820 Surgical instrument motors and accessories/attachments.
- 878.4830 Absorbable surgical gut suture.
- 878.4840 Absorbable polydioxanone surgical suture.
- 878.4860 Light based energy source device for topical application.
- 878.4930 Suture retention device.
- 878.4950 Manual operating table and accessories and manual operating chair and accessories.
- 878.4960 Operating tables and accessories and operating chairs and accessories.
- 878.5000 Nonabsorbable poly(ethylene terephthalate) surgical suture.
- 878.5010 Nonabsorbable polypropylene surgical suture.
- 878.5020 Nonabsorbable polyamide surgical suture.
- 878.5030 Natural nonabsorbable silk surgical suture.
- 878.5035 Nonabsorbable expanded polytetrafluoroethylene surgical suture.
- 878.5040 Suction lipoplasty system.
- 878.5050 Surgical smoke precipitator.

### Subpart F—Therapeutic Devices

- 878.5070 Air-handling apparatus for a surgical operating room.

## 21 CFR Ch. I (4–1–20 Edition)

- 878.5080 Air-handling apparatus accessory.
- 878.5350 Needle-type epilator.
- 878.5360 Tweezer-type epilator.
- 878.5400 Low level laser system for aesthetic use
- 878.5650 Topical oxygen chamber for extremities.
- 878.5900 Nonpneumatic tourniquet.
- 878.5910 Pneumatic tourniquet.

AUTHORITY: 21 U.S.C. 351, 360, 360c, 360e, 360j, 360l, 371.

SOURCE: 53 FR 23872, June 24, 1988, unless otherwise noted.

EDITORIAL NOTE: Nomenclature changes to part 878 appear at 73 FR 35341, June 23, 2008.

### Subpart A—General Provisions

#### § 878.1 Scope.

(a) This part sets forth the classification of general and plastic surgery devices intended for human use that are in commercial distribution.

(b) The identification of a device in a regulation in this part is not a precise description of every device that is, or will be, subject to the regulation. A manufacturer who submits a pre-market notification submission for a device under part 807 cannot show merely that the device is accurately described by the section title and identification provision of a regulation in this part, but shall state why the device is substantially equivalent to other devices, as required by § 807.87 of this chapter.

(c) To avoid duplicative listings, a general and plastic surgery device that has two or more types of uses (e.g., used both as a diagnostic device and as a therapeutic device) is listed in one subpart only.

(d) References in this part to regulatory sections of the Code of Federal Regulations are to chapter I of title 21 unless otherwise noted.

(e) Guidance documents referenced in this part are available on the Internet at <http://www.fda.gov/MedicalDevices/DeviceRegulationandGuidance/GuidanceDocuments/default.htm>.

[53 FR 23872, June 24, 1988, as amended at 67 FR 77676, Dec. 19, 2002; 78 FR 18233, Mar. 26, 2013]

**§ 878.3 Effective dates of requirement for premarket approval.**

A device included in this part that is classified into class III (premarket approval) shall not be commercially distributed after the date shown in the regulation classifying the device unless the manufacturer has an approval under section 515 of the act (unless an exemption has been granted under section 520(g)(2) of the act). An approval under section 515 of the act consists of FDA's issuance of an order approving an application for premarket approval (PMA) for the device or declaring completed a product development protocol (PDP) for the device.

(a) Before FDA requires that a device commercially distributed before the enactment date of the amendments, or a device that has been found substantially equivalent to such a device, has an approval under section 515 of the act, FDA must promulgate a regulation under section 515(b) of the act requiring such approval, except as provided in paragraphs (b) and (c) of this section. Such a regulation under section 515(b) of the act shall not be effective during the grace period ending on the 90th day after its promulgation or on the last day of the 30th full calendar month after the regulation that classifies the device into class III is effective, whichever is later. See section 501(f)(2)(B) of the act. Accordingly, unless an effective date of the requirement for premarket approval is shown in the regulation for a device classified into class III in this part, the device may be commercially distributed without FDA's issuance of an order approving a PMA or declaring completed a PDP for the device. If FDA promulgates a regulation under section 515(b) of the act requiring premarket approval for a device, section 501(f)(1)(A) of the act applies to the device.

(b) Any new, not substantially equivalent, device introduced into commercial distribution on or after May 28, 1976, including a device formerly marketed that has been substantially altered, is classified by statute (section 513(f) of the act) into class III without any grace period and FDA must have issued an order approving a PMA or declaring completed a PDP for the device before the device is commercially dis-

tributed unless it is reclassified. If FDA knows that a device being commercially distributed may be a "new" device as defined in this section because of any new intended use or other reasons, FDA may codify the statutory classification of the device into class III for such new use. Accordingly, the regulation for such a class III device states that as of the enactment date of the amendments, May 28, 1976, the device must have an approval under section 515 of the act before commercial distribution.

(c) A device identified in a regulation in this part that is classified into class III and that is subject to the transitional provisions of section 520(l) of the act is automatically classified by statute into class III and must have an approval under section 515 of the act before being commercially distributed. Accordingly, the regulation for such a class III transitional device states that as of the enactment date of the amendments, May 28, 1976, the device must have an approval under section 515 of the act before commercial distribution.

**§ 878.9 Limitations of exemptions from section 510(k) of the Federal Food, Drug, and Cosmetic Act (the act).**

The exemption from the requirement of premarket notification (section 510(k) of the act) for a generic type of class I or II device is only to the extent that the device has existing or reasonably foreseeable characteristics of commercially distributed devices within that generic type or, in the case of in vitro diagnostic devices, only to the extent that misdiagnosis as a result of using the device would not be associated with high morbidity or mortality. Accordingly, manufacturers of any commercially distributed class I or II device for which FDA has granted an exemption from the requirement of premarket notification must still submit a premarket notification to FDA before introducing or delivering for introduction into interstate commerce for commercial distribution the device when:

(a) The device is intended for a use different from the intended use of a legally marketed device in that generic type of device; e.g., the device is intended for a different medical purpose,

## § 878.1800

or the device is intended for lay use where the former intended use was by health care professionals only;

(b) The modified device operates using a different fundamental scientific technology than a legally marketed device in that generic type of device; e.g., a surgical instrument cuts tissue with a laser beam rather than with a sharpened metal blade, or an in vitro diagnostic device detects or identifies infectious agents by using deoxyribonucleic acid (DNA) probe or nucleic acid hybridization technology rather than culture or immunoassay technology; or

(c) The device is an in vitro device that is intended:

(1) For use in the diagnosis, monitoring, or screening of neoplastic diseases with the exception of immunohistochemical devices;

(2) For use in screening or diagnosis of familial or acquired genetic disorders, including inborn errors of metabolism;

(3) For measuring an analyte that serves as a surrogate marker for screening, diagnosis, or monitoring life-threatening diseases such as acquired immune deficiency syndrome (AIDS), chronic or active hepatitis, tuberculosis, or myocardial infarction or to monitor therapy;

(4) For assessing the risk of cardiovascular diseases;

(5) For use in diabetes management;

(6) For identifying or inferring the identity of a microorganism directly from clinical material;

(7) For detection of antibodies to microorganisms other than immunoglobulin G (IgG) or IgG assays when the results are not qualitative, or are used to determine immunity, or the assay is intended for use in matrices other than serum or plasma;

(8) For noninvasive testing as defined in § 812.3(k) of this chapter; and

(9) For near patient testing (point of care).

[65 FR 2317, Jan. 14, 2000]

## Subpart B—Diagnostic Devices

### § 878.1800 Speculum and accessories.

(a) *Identification.* A speculum is a device intended to be inserted into a body cavity to aid observation. It is either

## 21 CFR Ch. I (4–1–20 Edition)

nonilluminated or illuminated and may have various accessories.

(b) *Classification.* Class I (general controls). The device is exempt from the premarket notification procedures in subpart E of part 807 of this chapter, subject to the limitations in § 878.9.

[53 FR 23872, June 24, 1988, as amended at 54 FR 13827, Apr. 5, 1989; 59 FR 63010, Dec. 7, 1994; 66 FR 38802, July 25, 2001]

## Subpart C [Reserved]

## Subpart D—Prosthetic Devices

### § 878.3250 External facial fracture fixation appliance.

(a) *Identification.* An external facial fracture fixation appliance is a metal apparatus intended to be used during surgical reconstruction and repair to immobilize maxillofacial bone fragments in their proper facial relationship.

(b) *Classification.* Class I (general controls). The device is exempt from the premarket notification procedures in subpart E of part 807 of this chapter subject to § 878.9.

[53 FR 23872, June 24, 1988, as amended at 54 FR 13827, Apr. 5, 1989; 65 FR 2317, Jan. 14, 2000]

### § 878.3300 Surgical mesh.

(a) *Identification.* Surgical mesh is a metallic or polymeric screen intended to be implanted to reinforce soft tissue or bone where weakness exists. Examples of surgical mesh are metallic and polymeric mesh for hernia repair, and acetabular and cement restrictor mesh used during orthopedic surgery.

(b) *Classification.* Class II.

### § 878.3500 Polytetrafluoroethylene with carbon fibers composite implant material.

(a) *Identification.* A polytetrafluoroethylene with carbon fibers composite implant material is a porous device material intended to be implanted during surgery of the chin, jaw, nose, or bones or tissue near the eye or ear. The device material serves as a space-occupying substance and is shaped and formed by the surgeon to conform to the patient's need.

(b) *Classification.* Class II.

**§ 878.3530 Silicone inflatable breast prosthesis.**

(a) *Identification.* A silicone inflatable breast prosthesis is a silicone rubber shell made of polysiloxane(s), such as polydimethylsiloxane and polydiphenylsiloxane, that is inflated to the desired size with sterile isotonic saline before or after implantation. The device is intended to be implanted to augment or reconstruct the female breast.

(b) *Classification.* Class III.

(c) *Date PMA or notice of completion of a PDP is required.* A PMA or a notice of completion of a PDP is required to be filed with the Food and Drug Administration on or before November 17, 1999, for any silicone inflatable breast prosthesis that was in commercial distribution before May 28, 1976, or that has, on or before November 17, 1999, been found to be substantially equivalent to a silicone inflatable breast prosthesis that was in commercial distribution before May 28, 1976. Any other silicone inflatable breast prosthesis shall have an approved PMA or a declared completed PDP in effect before being placed in commercial distribution.

[53 FR 23872, June 24, 1988, as amended at 64 FR 45161, Aug. 19, 1999]

**§ 878.3540 Silicone gel-filled breast prosthesis.**

(a) *Identification*—(1) *Single-lumen silicone gel-filled breast prosthesis.* A single-lumen silicone gel-filled breast prosthesis is a silicone rubber shell made of polysiloxane(s), such as polydimethylsiloxane and polydiphenylsiloxane. The shell either contains a fixed amount cross-linked polymerized silicone gel, filler, and stabilizers or is filled to the desired size with injectable silicone gel at time of implantation. The device is intended to be implanted to augment or reconstruct the female breast.

(2) *Double-lumen silicone gel-filled breast prosthesis.* A double lumen silicone gel-filled breast prosthesis is a silicone rubber inner shell and a silicone rubber outer shell, both shells made of polysiloxane(s), such as polydimethylsiloxane and polydiphenylsiloxane. The inner shell contains fixed amounts of cross-linked polymerized silicone gel, fillers, and

stabilizers. The outer shell is inflated to the desired size with sterile isotonic saline before or after implantation. The device is intended to be implanted to augment or reconstruct the female breast.

(3) *Polyurethane covered silicone gel-filled breast prosthesis.* A polyurethane covered silicone gel-filled breast prosthesis is an inner silicone rubber shell made of polysiloxane(s), such as polydimethylsiloxane and polydiphenylsiloxane, with an outer silicone adhesive layer and an outer covering of polyurethane; contained within the inner shell is a fixed amount of cross-linked polymerized silicone gel, fillers, and stabilizers and an inert support structure compartmentalizing the silicone gel. The device is intended to be implanted to augment or reconstruct the female breast.

(b) *Classification.* Class III.

(c) *Date premarket approval application (PMA) is required.* A PMA is required to be filed with the Food and Drug Administration on or before July 9, 1991 for any silicone gel-filled breast prosthesis that was in commercial distribution before May 28, 1976, or that has on or before July 9, 1991 been found to be substantially equivalent to a silicone gel-filled breast prosthesis that was in commercial distribution before May 28, 1976. Any other silicone gel-filled breast prosthesis shall have an approved PMA in effect before being placed in commercial distribution.

[53 FR 23872, June 24, 1988, as amended at 56 FR 14627, Apr. 10, 1991]

**§ 878.3550 Chin prosthesis.**

(a) *Identification.* A chin prosthesis is a silicone rubber solid device intended to be implanted to augment or reconstruct the chin.

(b) *Classification.* Class II.

**§ 878.3590 Ear prosthesis.**

(a) *Identification.* An ear prosthesis is a silicone rubber solid device intended to be implanted to reconstruct the external ear.

(b) *Classification.* Class II.

**§ 878.3610 Esophageal prosthesis.**

(a) *Identification.* An esophageal prosthesis is a rigid, flexible, or expandable tubular device made of a plastic,

**§ 878.3680**

metal, or polymeric material that is intended to be implanted to restore the structure and/or function of the esophagus. The metal esophageal prosthesis may be uncovered or covered with a polymeric material. This device may also include a device delivery system.

(b) *Classification.* Class II. The special control for this device is FDA's "Guidance for the Content of Premarket Notification Submissions for Esophageal and Tracheal Prostheses."

[65 FR 17145, Mar. 31, 2000]

**§ 878.3680 Nose prosthesis.**

(a) *Identification.* A nose prosthesis is a silicone rubber solid device intended to be implanted to augment or reconstruct the nasal dorsum.

(b) *Classification.* Class II.

**§ 878.3720 Tracheal prosthesis.**

(a) *Identification.* The tracheal prosthesis is a rigid, flexible, or expandable tubular device made of a silicone, metal, or polymeric material that is intended to be implanted to restore the structure and/or function of the trachea or tracheobronchial tree. It may be unbranched or contain one or two branches. The metal tracheal prosthesis may be uncovered or covered with a polymeric material. This device may also include a device delivery system.

(b) *Classification.* Class II. The special control for this device is FDA's "Guidance for the Content of Premarket Notification Submissions for Esophageal and Tracheal Prostheses."

[65 FR 17146, Mar. 31, 2000]

**§ 878.3750 External prosthesis adhesive.**

(a) *Identification.* An external prosthesis adhesive is a silicone-type adhesive intended to be used to fasten to the body an external aesthetic restoration prosthesis, such as an artificial nose.

(b) *Classification.* Class I (general controls). The device is exempt from the premarket notification procedures in subpart E of part 807 of this chapter, subject to the limitations in § 878.9.

[53 FR 23872, June 24, 1988, as amended at 59 FR 63010, Dec. 7, 1994; 66 FR 38802, July 25, 2001]

**21 CFR Ch. I (4-1-20 Edition)**

**§ 878.3800 External aesthetic restoration prosthesis.**

(a) *Identification.* An external aesthetic restoration prosthesis is a device intended to be used to construct an external artificial body structure, such as an ear, breast, or nose. Usually the device is made of silicone rubber and it may be fastened to the body with an external prosthesis adhesive. The device is not intended to be implanted.

(b) *Classification.* Class I (general controls). The device is exempt from the premarket notification procedures in subpart E of part 807 of this chapter, subject to the limitations in § 878.9. If the device is intended for use without an external prosthesis adhesive to fasten it to the body, the device is exempt from the current good manufacturing practice requirements of the quality system regulation in part 820 of this chapter, with the exception of § 820.180, with respect to general requirements concerning records, and § 820.198, with respect to complaint files.

[53 FR 23872, June 24, 1988, as amended at 59 FR 63010, Dec. 7, 1994; 66 FR 38802, July 25, 2001]

**§ 878.3900 Inflatable extremity splint.**

(a) *Identification.* An inflatable extremity splint is a device intended to be inflated to immobilize a limb or an extremity.

(b) *Classification.* Class I (general controls). The device is exempt from the premarket notification procedures in subpart E of part 807 of this chapter, subject to the limitations in § 878.9.

[53 FR 23872, June 24, 1988, as amended at 59 FR 63010, Dec. 7, 1994; 66 FR 38802, July 25, 2001]

**§ 878.3910 Noninflatable extremity splint.**

(a) *Identification.* A noninflatable extremity splint is a device intended to immobilize a limb or an extremity. It is not inflatable.

(b) *Classification.* Class I (general controls). The device is exempt from the premarket notification procedures in subpart E of part 807 of this chapter subject to § 878.9. If the device is not labeled or otherwise represented as sterile, it is exempt from the current good manufacturing practice requirements



of the quality system regulation in part 820 of this chapter, with the exception of § 820.180 of this chapter, with respect to general requirements concerning records, and § 820.198 of this chapter, with respect to complaint files.

[53 FR 23872, June 24, 1988, as amended at 54 FR 13827, Apr. 5, 1989; 65 FR 2317, Jan. 14, 2000]

**§ 878.3925 Plastic surgery kit and accessories.**

(a) *Identification.* A plastic surgery kit and accessories is a device intended to be used to reconstruct maxillofacial deficiencies. The kit contains surgical instruments and materials used to make maxillofacial impressions before molding an external prosthesis.

(b) *Classification.* Class I (general controls). The device is exempt from the premarket notification procedures in subpart E of part 807 of this chapter subject to § 878.9.

[53 FR 23872, June 24, 1988, as amended at 54 FR 13827, Apr. 5, 1989; 65 FR 2317, Jan. 14, 2000]

**Subpart E—Surgical Devices**

**§ 878.4010 Tissue adhesive.**

(a) *Tissue adhesive for the topical approximation of skin—(1) Identification.* A tissue adhesive for the topical approximation of skin is a device intended for topical closure of surgical incisions, including laparoscopic incisions, and simple traumatic lacerations that have easily approximated skin edges. Tissue adhesives for the topical approximation of skin may be used in conjunction with, but not in place of, deep dermal stitches.

(2) *Classification.* Class II (special controls). The special control for this device is FDA's "Class II Special Controls Guidance Document: "Tissue Adhesive for the Topical Approximation of Skin." See § 878.1(e) of this chapter for the availability of this guidance document.

(b) *Tissue adhesive for non-topical use—(1) Identification.* A tissue adhesive for non-topical use, including adhesives intended for use in the embolization of brain arteriovenous malformation or for use in ophthalmic surgery, is a de-

vice used for adhesion of internal tissues and vessels.

(2) *Classification.* Class III (premarket approval). As of May 28, 1976, an approval under section 515 of the act is required before this device may be commercially distributed. See § 878.3 of this chapter.

[73 FR 31033, May 30, 2008]

**§ 878.4011 Tissue adhesive with adjunct wound closure device for topical approximation of skin.**

(a) *Identification.* A tissue adhesive with adjunct wound closure device intended for the topical approximation of skin is a device indicated for topical application only to hold closed easily approximated skin edges of wounds from surgical incisions, including punctures from minimally invasive surgery, and simple, thoroughly cleansed, trauma-induced lacerations. It may be used in conjunction with, but not in place of, deep dermal stitches. Additionally, the adjunct wound closure device component maintains temporary skin edge alignment along the length of wound during application of the liquid adhesive.

(b) *Classification.* Class II (special controls). The special control for this device is FDA's "Guidance for Industry and FDA Staff; Class II Special Controls Guidance Document: Tissue Adhesive with Adjunct Wound Closure Device Intended for the Topical Approximation of Skin." See § 878.1(e) for the availability of this guidance document.

[75 FR 68794, Nov. 10, 2010]

**§ 878.4014 Nonresorbable gauze/sponge for external use.**

(a) *Identification.* A nonresorbable gauze/sponge for external use is a sterile or nonsterile device intended for medical purposes, such as to be placed directly on a patient's wound to absorb exudate. It consists of a strip, piece, or pad made from open woven or nonwoven mesh cotton cellulose or a simple chemical derivative of cellulose. This classification does not include a nonresorbable gauze/sponge for external use that contains added drugs such as antimicrobial agents, added biologics such as growth factors, or is

## § 878.4015

## 21 CFR Ch. I (4–1–20 Edition)

composed of materials derived from animal sources.

(b) *Classification.* Class I (general controls). The device is exempt from the premarket notification procedures in part 807, subpart E of this chapter subject to the limitations in § 878.9.

[64 FR 53929, Oct. 5, 1999]

### § 878.4015 Wound dressing with poly (diallyl dimethyl ammonium chloride) (pDADMAC) additive.

(a) *Identification.* A wound dressing with pDADMAC additive is intended for use as a primary dressing for exuding wounds, 1st and 2d degree burns, and surgical wounds, to secure and prevent movement of a primary dressing, and as a wound packing.

(b) *Classification.* Class II (special controls). The special control is: the FDA guidance document entitled “Class II Special Controls Guidance Document: Wound Dressing With Poly (Diallyl Dimethyl Ammonium Chloride) (pDADMAC) Additive.” See § 878.1(e) for availability of this guidance document.

[74 FR 53167, Oct. 16, 2009]

### § 878.4018 Hydrophilic wound dressing.

(a) *Identification.* A hydrophilic wound dressing is a sterile or non-sterile device intended to cover a wound and to absorb exudate. It consists of nonresorbable materials with hydrophilic properties that are capable of absorbing exudate (e.g., cotton, cotton derivatives, alginates, dextran, and rayon). This classification does not include a hydrophilic wound dressing that contains added drugs such as antimicrobial agents, added biologics such as growth factors, or is composed of materials derived from animal sources.

(b) *Classification.* Class I (general controls). The device is exempt from the premarket notification procedures in part 807, subpart E of this chapter subject to the limitations in § 878.9.

[64 FR 53929, Oct. 5, 1999]

### § 878.4020 Oclusive wound dressing.

(a) *Identification.* An oclusive wound dressing is a nonresorbable, sterile or non-sterile device intended to cover a wound, to provide or support a moist

wound environment, and to allow the exchange of gases such as oxygen and water vapor through the device. It consists of a piece of synthetic polymeric material, such as polyurethane, with or without an adhesive backing. This classification does not include an occlusive wound dressing that contains added drugs such as antimicrobial agents, added biologics such as growth factors, or is composed of materials derived from animal sources.

(b) *Classification.* Class I (general controls). The device is exempt from the premarket notification procedures in part 807, subpart E of this chapter subject to the limitations in § 878.9.

[64 FR 53929, Oct. 5, 1999]

### § 878.4022 Hydrogel wound dressing and burn dressing.

(a) *Identification.* A hydrogel wound dressing is a sterile or non-sterile device intended to cover a wound, to absorb wound exudate, to control bleeding or fluid loss, and to protect against abrasion, friction, desiccation, and contamination. It consists of a nonresorbable matrix made of hydrophilic polymers or other material in combination with water (at least 50 percent) and capable of absorbing exudate. This classification does not include a hydrogel wound dressing that contains added drugs such as antimicrobial agents, added biologics such as growth factors, or is composed of materials derived from animal sources.

(b) *Classification.* Class I (general controls). The device is exempt from the premarket notification procedures in part 807, subpart E of this chapter subject to the limitations in § 878.9.

[64 FR 53929, Oct. 5, 1999]

### § 878.4025 Silicone sheeting.

(a) *Identification.* Silicone sheeting is intended for use in the management of closed hyperproliferative (hypertrophic and keloid) scars.

(b) *Classification.* Class I (general controls). The device is exempt from the premarket notification procedures in subpart E of part 807 of this chapter subject to the limitations in § 878.9.

[69 FR 48148, Aug. 9, 2004]

**§ 878.4040 Surgical apparel.**

(a) *Identification.* Surgical apparel are devices that are intended to be worn by operating room personnel during surgical procedures to protect both the surgical patient and the operating room personnel from transfer of microorganisms, body fluids, and particulate material. Examples include surgical caps, hoods, masks, gowns, operating room shoes and shoe covers, and isolation masks and gowns. Surgical suits and dresses, commonly known as scrub suits, are excluded.

(b) *Classification.* (1) Class II (special controls) for surgical gowns and surgical masks. A surgical N95 respirator or N95 filtering facepiece respirator is not exempt if it is intended to prevent specific diseases or infections, or it is labeled or otherwise represented as filtering surgical smoke or plumes, filtering specific amounts of viruses or bacteria, reducing the amount of and/or killing viruses, bacteria, or fungi, or affecting allergenicity, or it contains coating technologies unrelated to filtration (e.g., to reduce and or kill microorganisms). Surgical N95 respirators and N95 filtering facepiece respirators are exempt from the premarket notification procedures in subpart E of part 807 of this chapter subject to § 878.9, and the following conditions for exemption:

(i) The user contacting components of the device must be demonstrated to be biocompatible.

(ii) Analysis and nonclinical testing must:

(A) Characterize flammability and be demonstrated to be appropriate for the intended environment of use; and

(B) Demonstrate the ability of the device to resist penetration by fluids, such as blood and body fluids, at a velocity consistent with the intended use of the device.

(iii) NIOSH approved under its regulation.

(2) Class I (general controls) for surgical apparel other than surgical gowns and surgical masks. The class I device is exempt from the premarket notification procedures in subpart E of part 807 of this chapter subject to § 878.9.

[53 FR 23872, June 24, 1988, as amended at 65 FR 2317, Jan. 14, 2000; 83 FR 22848, May 17, 2018]

**§ 878.4100 Organ bag.**

(a) *Identification.* An organ bag is a device that is a flexible plastic bag intended to be used as a temporary receptacle for an organ during surgical procedures to prevent moisture loss.

(b) *Classification.* Class I (general controls). The device is exempt from the premarket notification procedures in subpart E of part 807 of this chapter subject to § 878.9.

[53 FR 23872, June 24, 1988, as amended at 59 FR 63010, Dec. 7, 1994; 65 FR 2318, Jan. 14, 2000]

**§ 878.4160 Surgical camera and accessories.**

(a) *Identification.* A surgical camera and accessories is a device intended to be used to record operative procedures.

(b) *Classification.* Class I (general controls). The device is exempt from the premarket notification procedures in subpart E of part 807 of this chapter, subject to the limitations in § 878.9.

[53 FR 23872, June 24, 1988, as amended at 54 FR 13827, Apr. 5, 1989; 66 FR 38802, July 25, 2001]

**§ 878.4165 Wound autofluorescence imaging device.**

(a) *Identification.* A wound autofluorescence imaging device is a tool to view autofluorescence images from skin wounds that are exposed to an excitation light. The device is not intended to provide quantitative or diagnostic information.

(b) *Classification.* Class I (general controls). The device is exempt from the premarket notification procedures in subpart E of part 807 of this chapter, subject to the limitations in § 878.9.

[83 FR 52968, Oct. 19, 2018]

**§ 878.4200 Introduction/drainage catheter and accessories.**

(a) *Identification.* An introduction/drainage catheter is a device that is a flexible single or multilumen tube intended to be used to introduce nondrug fluids into body cavities other than blood vessels, drain fluids from body cavities, or evaluate certain physiologic conditions. Examples include irrigation and drainage catheters, pediatric catheters, peritoneal catheters (including dialysis), and other general

**§ 878.4300**

**21 CFR Ch. I (4–1–20 Edition)**

surgical catheters. An introduction/drainage catheter accessory is intended to aid in the manipulation of or insertion of the device into the body. Examples of accessories include adaptors, connectors, and catheter needles.

(b) *Classification.* Class I (general controls). The device is exempt from the premarket notification procedures in subpart E of part 807 of this chapter subject to § 878.9.

[53 FR 23872, June 24, 1988, as amended at 65 FR 2318, Jan. 14, 2000]

**§ 878.4300 Implantable clip.**

(a) *Identification.* An implantable clip is a clip-like device intended to connect internal tissues to aid healing. It is not absorbable.

(b) *Classification.* Class II.

**§ 878.4320 Removable skin clip.**

(a) *Identification.* A removable skin clip is a clip-like device intended to connect skin tissues temporarily to aid healing. It is not absorbable.

(b) *Classification.* Class I (general controls). The device is exempt from the premarket notification procedures in subpart E of part 807 of this chapter subject to § 878.9.

[53 FR 23872, June 24, 1988, as amended at 65 FR 2318, Jan. 14, 2000]

**§ 878.4340 Contact cooling system for aesthetic use.**

(a) *Identification.* A contact cooling system for aesthetic use is a device that is a combination of a cooling pad associated with a vacuum or mechanical massager intended for the disruption of adipocyte cells intended for non-invasive aesthetic use.

(b) *Classification.* Class II (special controls). The special controls for this device is FDA's "Guidance for Industry and FDA Staff; Class II Special Controls Guidance Document: Contact Cooling System for Aesthetic Use." See § 878.1(e) for the availability of this guidance document.

[76 FR 6553, Feb. 7, 2011]

**§ 878.4350 Cryosurgical unit and accessories.**

(a) *Identification*—(1) *Cryosurgical unit with a liquid nitrogen cooled cryoprobe and accessories.* A cryosurgical unit

with a liquid nitrogen cooled cryoprobe and accessories is a device intended to destroy tissue during surgical procedures by applying extreme cold.

(2) *Cryosurgical unit with a nitrous oxide cooled cryoprobe and accessories.* A cryosurgical unit with a nitrous oxide cooled cryoprobe and accessories is a device intended to destroy tissue during surgical procedures, including urological applications, by applying extreme cold.

(3) *Cryosurgical unit with a carbon dioxide cooled cryoprobe or a carbon dioxide dry ice applicator and accessories.* A cryosurgical unit with a carbon dioxide cooled cryoprobe or a carbon dioxide dry ice applicator and accessories is a device intended to destroy tissue during surgical procedures by applying extreme cold. The device is intended to treat disease conditions such as tumors, skin cancers, acne scars, or hemangiomas (benign tumors consisting of newly formed blood vessels) and various benign or malignant gynecological conditions affecting vulvar, vaginal, or cervical tissue. The device is not intended for urological applications.

(b) *Classification.* Class II.

**§ 878.4360 Scalp cooling system to reduce the likelihood of chemotherapy-induced alopecia.**

(a) *Identification.* A scalp cooling system to reduce the likelihood of chemotherapy-induced alopecia is a prescription device intended to reduce the frequency and severity of alopecia during chemotherapy in which alopecia-inducing chemotherapeutic agents are used.

(b) *Classification*—Class II (special controls). The special controls for this device are:

(1) Non-clinical performance testing must demonstrate that the device meets all design specifications and performance requirements, and that the device performs as intended under anticipated conditions of use. This information must include testing to demonstrate accuracy of the temperature control mechanism.

(2) Performance testing must demonstrate the electromagnetic compatibility and electrical safety of the device.

(3) Software verification, validation, and hazard analysis must be performed.

(4) The patient contacting components of the device must be demonstrated to be biocompatible. Material names must be provided.

(5) Labeling must include the following:

(i) A statement describing the potential risk of developing scalp metastasis.

(ii) Information on the patient population and chemotherapeutic agents/regimen for which the device has been demonstrated to be effective.

(iii) A summary of the non-clinical and/or clinical testing pertinent to use of the device.

(iv) A summary of the device technical parameters, including temperature cooling range and duration of cooling.

(v) A summary of the device- and procedure-related adverse events pertinent to use of the device.

(vi) Information on how the device operates and the typical course of treatment.

(6) Patient labeling must be provided and must include:

(i) Relevant contraindications, warnings, precautions, and adverse effects/complications.

(ii) Information on how the device operates and the typical course of treatment.

(iii) Information on the patient population for which there is clinical evidence of effectiveness.

(iv) The potential risks and benefits associated with use of the device.

(v) Postoperative care instructions.

(vi) A statement describing the potential risk of developing scalp metastasis.

[81 FR 7453, Feb. 12, 2016]

**§ 878.4370 Surgical drape and drape accessories.**

(a) *Identification.* A surgical drape and drape accessories is a device made of natural or synthetic materials intended to be used as a protective patient covering, such as to isolate a site of surgical incision from microbial and other contamination. The device includes a plastic wound protector that may adhere to the skin around a surgical incision or be placed in a wound

to cover its exposed edges, and a latex drape with a self-retaining finger cot that is intended to allow repeated insertion of the surgeon's finger into the rectum during performance of a transurethral prostatectomy.

(b) *Classification.* Class II (special controls). The device, when it is an ear, nose, and throat surgical drape, a latex sheet drape with self-retaining finger cot, a disposable urological drape, a Kelly pad, an ophthalmic patient drape, an ophthalmic microscope drape, an internal drape retention ring (wound protector), or a surgical drape that does not include an antimicrobial agent, is exempt from the premarket notification procedures in subpart E of part 807 of this chapter subject to the limitations in § 878.9.

[53 FR 23872, June 24, 1988, as amended at 84 FR 71814, Dec. 30, 2019]

**§ 878.4371 Irrigating wound retractor device.**

(a) *Identification.* An irrigating wound retractor device is a prescription device intended to be used by a surgeon to retract the surgical incision, to provide access to the surgical wound, to protect and irrigate the surgical wound, and to serve as a conduit for removal of fluid from the surgical wound.

(b) *Classification.* Class II (special controls). The special controls for this device are:

(1) The patient-contacting components of the device must be demonstrated to be biocompatible and evaluated for particulate matter.

(2) Performance data must demonstrate the sterility and pyrogenicity of the patient-contacting components of the device.

(3) Performance data must support shelf life by demonstrating continued functionality and sterility of the device over the identified shelf life.

(4) Non-clinical performance testing must demonstrate that the device performs as intended under anticipated conditions of use. Performance testing must:

(i) Characterize the tear resistance, tensile strength, and elongation properties of the barrier material;

(ii) Demonstrate that the liquid barrier material is resistant to penetration by blood, and is non-flammable;

**§ 878.4380**

(iii) Characterize the forces required to deploy the device;

(iv) Characterize the device's ranges of operation, including flow rates and maximum suction pressures;

(v) Demonstrate the ability of the device irrigation apparatus to maintain a user defined or preset flow rate to the surgical wound; and

(vi) Demonstrate the ability of the device to maintain user defined or preset removal rates of fluid from the surgical wound.

(5) The labeling must include or state the following information:

(i) Device size or incision length range;

(ii) Method of sterilization;

(iii) Flammability classification;

(iv) Non-pyrogenic;

(v) Shelf life; and

(vi) Maximum flow rate and suction pressure.

[83 FR 24, Jan. 2, 2018]

**§ 878.4380 Drape adhesive.**

(a) *Identification.* A drape adhesive is a device intended to be placed on the skin to attach a surgical drape.

(b) *Classification.* Class I (general controls). The device is exempt from the premarket notification procedures in subpart E of part 807 of this chapter, subject to the limitations in § 878.9.

[53 FR 23872, June 24, 1988, as amended at 59 FR 63010, Dec. 7, 1994; 66 FR 38802, July 25, 2001]

**§ 878.4400 Electrosurgical cutting and coagulation device and accessories.**

(a) *Identification.* An electrosurgical cutting and coagulation device and accessories is a device intended to remove tissue and control bleeding by use of high-frequency electrical current.

(b) *Classification.* Class II.

**§ 878.4410 Low energy ultrasound wound cleaner.**

(a) *Identification.* A low energy ultrasound wound cleaner is a device that uses ultrasound energy to vaporize a solution and generate a mist that is used for the cleaning and maintenance debridement of wounds. Low levels of ultrasound energy may be carried to the wound by the saline mist.

**21 CFR Ch. I (4–1–20 Edition)**

(b) *Classification.* Class II (special controls). The special control is FDA's guidance document entitled "Class II Special Controls Guidance Document: Low Energy Ultrasound Wound Cleaner." See § 878.1(e) for the availability of this guidance document.

[70 FR 67355, Nov. 7, 2005]

**§ 878.4420 Electrosurgical device for over-the-counter aesthetic use.**

(a) *Identification.* An electrosurgical device for over-the-counter aesthetic use is a device using radiofrequency energy to produce localized heating within tissues for non-invasive aesthetic use.

(b) *Classification.* Class II (special controls). The special controls for this device are:

(1) Non-clinical performance data must demonstrate that the device meets all design specifications and performance requirements. The following performance characteristics must be tested: Over-heating, power accuracy, radiofrequency, pulse cycle, waveform, pulse duration, and device characterization parameters.

(2) Label comprehension and self-selection performance evaluation must demonstrate that the intended over-the-counter users can understand the package labeling and correctly choose the device for the indicated aesthetic use.

(3) Usability performance evaluation must demonstrate that the over-the-counter user can correctly use the device, based solely on reading the directions for use, to treat the indicated aesthetic use.

(4) Clinical performance evaluation must demonstrate that the device performs as intended under anticipated conditions of use to achieve the intended aesthetic results.

(5) The patient-contacting components of the device must be demonstrated to be biocompatible.

(6) Instructions for cleaning the device must be validated.

(7) Performance data must be provided to demonstrate the electromagnetic compatibility and electrical safety, including the mechanical integrity, of the device.

(8) Software verification, validation, and hazard analysis must be performed.

(9) Labeling must include:

(i) Warnings, precautions, and contraindications to ensure the safe use of the device for the over-the-counter users.

(ii) A statement that the safety and effectiveness of the device's use for uses other than the indicated aesthetic use are not known.

(iii) A summary of the clinical information used to establish effectiveness for each indicated aesthetic usage and observed adverse events.

[81 FR 42244, June 29, 2016]

**§ 878.4430 Microneedling device for aesthetic use.**

(a) *Identification.* A microneedling device for aesthetic use is a device using one or more needles to mechanically puncture and injure skin tissue for aesthetic use. This classification does not include devices intended for transdermal delivery of topical products such as cosmetics, drugs, or biologics.

(b) *Classification.* Class II (special controls). The special controls for this device are:

(1) The technical specifications and needle characteristics must be identified, including needle length, geometry, maximum penetration depth, and puncture rate.

(2) Non-clinical performance data must demonstrate that the device performs as intended under anticipated conditions of use. The following performance characteristics must be tested:

(i) Accuracy of needle penetration depth and puncture rate;

(ii) Safety features built into the device to protect against cross-contamination, including fluid ingress protection; and

(iii) Identification of the maximum safe needle penetration depth for the device for the labeled indications for use.

(3) Performance data must demonstrate the sterility of the patient-contacting components of the device.

(4) Performance data must support the shelf life of the device by demonstrating continued sterility, package integrity, and device functionality over the intended shelf life.

(5) Performance data must demonstrate the electrical safety and electromagnetic compatibility (EMC) of all electrical components of the device.

(6) Software verification, validation, and hazard analysis must be performed for all software components of the device.

(7) The patient-contacting components of the device must be demonstrated to be biocompatible.

(8) Performance data must validate the cleaning and disinfection instructions for reusable components of the device.

(9) Labeling must include the following:

(i) Information on how to operate the device and its components and the typical course of treatment;

(ii) A summary of the device technical parameters, including needle length, needle geometry, maximum penetration depth, and puncture rate;

(iii) Validated methods and instructions for reprocessing of any reusable components;

(iv) Disposal instructions; and

(v) A shelf life.

(10) Patient labeling must be provided and must include:

(i) Information on how the device operates and the typical course of treatment;

(ii) The probable risks and benefits associated with use of the device; and

(iii) Postoperative care instructions.

[83 FR 26577, June 8, 2018]

**§ 878.4440 Eye pad.**

(a) *Identification.* An eye pad is a device that consists of a pad made of various materials, such as gauze and cotton, intended for use as a bandage over the eye for protection or absorption of secretions.

(b) *Classification.* Class I (general controls). The device is exempt from the premarket notification procedures in subpart E of part 807 of this chapter, subject to the limitations in § 878.9.

[53 FR 23872, June 24, 1988, as amended at 59 FR 63010, Dec. 7, 1994; 66 FR 38803, July 25, 2001]

**§ 878.4450 Nonabsorbable gauze for internal use.**

(a) *Identification.* Nonabsorbable gauze for internal use is a device made

of an open mesh fabric intended to be used inside the body or a surgical incision or applied to internal organs or structures, to control bleeding, absorb fluid, or protect organs or structures from abrasion, drying, or contamination. The device is woven from material made of not less than 50 percent by mass cotton, cellulose, or a simple chemical derivative of cellulose, and contains x-ray detectable elements.

(b) *Classification.* Class I (general controls). The device is exempt from the premarket notification procedures in subpart E of part 807 of this chapter, subject to the limitations in § 878.9.

[53 FR 23872, June 24, 1988, as amended at 61 FR 1123, Jan. 16, 1996; 66 FR 38803, July 25, 2001]

**§ 878.4452 Nonabsorbable expandable hemostatic sponge for temporary internal use.**

(a) *Identification.* A nonabsorbable expandable hemostatic sponge for temporary internal use is a prescription device intended to be placed temporarily into junctional, non-compressible wounds, which are not amenable to tourniquet use, to control bleeding until surgical care is acquired. The sponges expand upon contact with blood to fill the wound cavity and provide a physical barrier and pressure that facilitates formation of a clot. The device consists of sterile, non-absorbable radiopaque compressed sponges and may include an applicator to facilitate delivery into a wound.

(b) *Classification.* Class II (special controls). The special controls for this device are:

(1) Performance data must demonstrate the biocompatibility of patient-contacting components.

(2) Performance data must demonstrate the sterility of patient-contacting components including endotoxin and pyrogenicity assessments.

(3) Performance data must support device stability by demonstrating continued sterility of the patient-contacting components of the device, package integrity, and device functionality over the requested shelf life.

(4) Assessment of material characteristics must be sufficient to support

safety under anticipated conditions of use. Assessments must include the following:

(i) Material specifications.

(ii) Immunogenicity.

(iii) Viral inactivation for animal-derived materials.

(5) Non-clinical performance data must demonstrate that the device performs as intended under anticipated conditions of use. The following performance characteristics must be tested:

(i) Absorption capacity.

(ii) Extent of swelling.

(iii) Mechanical properties.

(iv) Expansion force/pressure.

(v) Radiopacity.

(vi) Deployment/applicator functionality.

(6) In vivo performance data must demonstrate safe and effective use by verifying that the device performs as intended under anticipated conditions of use. Appropriate analysis/testing must demonstrate that the product: Controls bleeding, does not promote adverse local or systemic effects, and can be completely removed from the wound. The following performance characteristics must be tested:

(i) Deployment.

(ii) Control of bleeding.

(iii) Radiopacity.

(iv) Retrieval.

(v) Assessment of local and systemic effects.

(7) Human factors testing and analysis must validate that the device design and labeling are sufficient for appropriate use by emergency responders deploying the device as well as surgeons retrieving the device from wounds.

(8) Labeling must include:

(i) Specific instructions for deployment by emergency responders and retrieval by surgeons.

(ii) Warnings, cautions, and limitations needed for safe use of the device.

(iii) Information on how the device operates and the typical course of treatment.

(iv) A detailed summary of the in vivo and human factors testing pertinent to use of the device.

(v) Appropriate imaging information to ensure complete retrieval of device.



- (vi) An expiration date/shelf life.

[79 FR 34224, June 16, 2014]

**§ 878.4454 Non-absorbable, hemostatic gauze for temporary internal use.**

(a) *Identification.* A non-absorbable, hemostatic gauze for temporary internal use is a prescription device intended to be placed temporarily for control of severely bleeding wounds such as surgical wounds and traumatic injuries. The gauze is coated or impregnated with a hemostatic material which may enhance hemostasis by physical means. The device is intended to be removed once the patient is stabilized.

(b) *Classification.* Class II (special controls). The special controls for this device are:

(1) Animal performance testing must demonstrate that the device performs as intended under anticipated conditions of use. Specifically testing must:

- (i) Demonstrate that the device is able to achieve hemostasis;
- (ii) Demonstrate that the device can be radiographically detected; and
- (iii) Assess pertinent safety endpoints including vascular obstruction and adhesion formation.

(2) The device must be demonstrated to be biocompatible.

(3) Non-clinical performance data must demonstrate that the device performs as intended under anticipated conditions of use. The following tests must be performed:

- (i) In vitro clot assessment;
- (ii) Particulate release testing;
- (iii) Physical characterization, including swelling percent and particulate size;
- (iv) Chemical characterization;
- (v) Radiopacity testing; and
- (vi) Mechanical integrity testing, including tensile strength and tear strength.

(4) Performance data must demonstrate the sterility of the device.

(5) Performance data must support the shelf life of the device by demonstrating continued sterility, package integrity, and device functionality over the identified shelf life.

(6) Labeling must include the following:

(i) Instructions for use, including an instruction to remove all visible device components by irrigation;

(ii) The maximum amount of time the device may be left within the body;

(iii) A shelf life;

(iv) A contraindication for intravascular use of the device; and

(v) A warning regarding the potential for adhesion formation.

[83 FR 6794, Feb. 15, 2018]

**§ 878.4456 Hemostatic device for intraluminal gastrointestinal use.**

(a) *Identification.* A hemostatic device for intraluminal gastrointestinal use is a prescription device that is endoscopically applied to the upper and/or lower gastrointestinal tract and is intended to produce hemostasis via absorption of fluid or by other physical means.

(b) *Classification.* Class II (special controls). The special controls for this device are:

(1) The device must be demonstrated to be biocompatible.

(2) Performance data must support the sterility and pyrogenicity of the device.

(3) Performance data must support the shelf life of the device by demonstrating continued sterility, package integrity, and device functionality over the identified shelf life.

(4) In vivo performance testing must demonstrate that the device performs as intended under anticipated conditions of use. The testing must evaluate the following:

(i) The ability to deliver the hemostatic material to the bleeding site;

(ii) The ability to achieve hemostasis in a clinically relevant model of gastrointestinal bleeding; and

(iii) Safety endpoints, including thromboembolic events, local and systemic toxicity, tissue trauma, gastrointestinal tract obstruction, and bowel distension and perforation.

(5) Non-clinical performance testing must demonstrate that the device performs as intended under anticipated conditions of use. The following performance characteristics must be evaluated:

(i) Materials characterization of all components must demonstrate the device meets established specifications,

**§ 878.4460**

**21 CFR Ch. I (4–1–20 Edition)**

which must include compositional identity and purity, characterization of impurities, physical characteristics, and reactivity with fluids.

(ii) Performance testing must demonstrate the mechanical integrity and functionality of the system used to deliver the device and demonstrate the device meets established specifications, including output pressure for propellant-based systems.

(6) Labeling must include:

(i) Information identifying and explaining how to use the device and its components; and

(ii) A shelf life.

[83 FR 52971, Oct. 19, 2018]

**§ 878.4460 Non-powdered surgeon's glove.**

(a) *Identification.* A non-powdered surgeon's glove is a device intended to be worn on the hands of operating room personnel to protect a surgical wound from contamination. A non-powdered surgeon's glove does not incorporate powder for purposes other than manufacturing. The final finished glove includes only residual powder from manufacturing.

(b) *Classification.* Class I (general controls).

[53 FR 23872, June 24, 1988, as amended at 66 FR 46952, Sept. 10, 2001; 81 FR 91730, Dec. 19, 2016]

**§ 878.4470 Surgeon's gloving cream.**

(a) *Identification.* Surgeon's gloving cream is an ointment intended to be used to lubricate the user's hand before putting on a surgeon's glove.

(b) *Classification.* Class I (general controls). The device is exempt from the premarket notification procedures in subpart E of part 807 of this chapter, subject to the limitations in § 878.9.

[53 FR 23872, June 24, 1988, as amended at 59 FR 63010, Dec. 7, 1994; 66 FR 38803, July 25, 2001]

**§ 878.4490 Absorbable hemostatic agent and dressing.**

(a) *Identification.* An absorbable hemostatic agent or dressing is a device intended to produce hemostasis by accelerating the clotting process of blood. It is absorbable.

(b) *Classification.* Class III.

(c) *Date PMA or notice of completion of a PDP is required.* As of May 28, 1976, an approval under section 515 of the act is required before this device may be commercially distributed. See § 878.3.

**§ 878.4493 Absorbable poly(glycolide/l-lactide) surgical suture.**

(a) *Identification.* An absorbable poly(glycolide/l-lactide) surgical suture (PGL suture) is an absorbable sterile, flexible strand as prepared and synthesized from homopolymers of glycolide and copolymers made from 90 percent glycolide and 10 percent l-lactide, and is indicated for use in soft tissue approximation. A PGL suture meets United States Pharmacopeia (U.S.P.) requirements as described in the U.S.P. "Monograph for Absorbable Surgical Sutures;" it may be monofilament or multifilament (braided) in form; it may be uncoated or coated; and it may be undyed or dyed with an FDA-approved color additive. Also, the suture may be provided with or without a standard needle attached.

(b) *Classification.* Class II (special controls). The special control for this device is FDA's "Class II Special Controls Guidance Document: Surgical Sutures; Guidance for Industry and FDA." See § 878.1(e) for the availability of this guidance document.

[56 FR 47151, Sept. 18, 1991, as amended at 68 FR 32984, June 3, 2003]

**§ 878.4494 Absorbable poly(hydroxybutyrate) surgical suture produced by recombinant DNA technology.**

(a) *Identification.* An absorbable poly(hydroxybutyrate) surgical suture is an absorbable surgical suture made of material isolated from prokaryotic cells produced by recombinant deoxyribonucleic acid (DNA) technology. The device is intended for use in general soft tissue approximation and ligation.

(b) *Classification.* Class II (special controls). The special control for this device is the FDA guidance document entitled "Class II Special Controls Guidance Document: Absorbable Poly(hydroxybutyrate) Surgical Suture

Produced by Recombinant DNA Technology.” For the availability of this guidance document see § 878.1(e).

[72 FR 43146, Aug. 3, 2007]

**§ 878.4495 Stainless steel suture.**

(a) *Identification.* A stainless steel suture is a needled or unneedled non-absorbable surgical suture composed of 316L stainless steel, in USP sizes 12-0 through 10, or a substantially equivalent stainless steel suture, intended for use in abdominal wound closure, intestinal anastomosis, hernia repair, and sternal closure.

(b) *Classification.* Class II (special controls). The device, when it is a steel monofilament suture that is uncoated and does not incorporate barbs, is exempt from the premarket notification procedures in subpart E of part 807 of this chapter subject to the limitations in § 878.9. The special control for this device is FDA’s “Class II Special Controls Guidance Document: Surgical Sutures; Guidance for Industry and FDA.” See § 878.1(e) for the availability of this guidance document.

[65 FR 19836, Apr. 13, 2000, as amended at 68 FR 32984, June 3, 2003; 84 FR 71814, Dec. 30, 2019]

**§ 878.4520 Polytetrafluoroethylene injectable.**

(a) *Identification.* Polytetrafluoroethylene injectable is an injectable paste prosthetic device composed of polytetrafluoroethylene intended to be used to augment or reconstruct a vocal cord.

(b) *Classification.* Class III.

(c) *Date PMA or notice of completion of a PDP is required.* As of May 28, 1976, an approval under section 515 of the act is required before this device may be commercially distributed. See § 878.3.

**§ 878.4580 Surgical lamp.**

(a) *Identification.* A surgical lamp (including a fixture) is a device intended to be used to provide visible illumination of the surgical field or the patient.

(b) *Classification.* Class II (special controls). The device, when it is an operating room lamp, a surgical instrument light, a surgical floor standing light, an endoscopic surgical light, a surgical light connector, a ceiling

mounted surgical light, a surgical light carrier, surgical light accessories, a surgical lamp, a remote illuminator, or an incandescent surgical lamp, is exempt from the premarket notification procedures in subpart E of part 807 of this chapter subject to the limitations in § 878.9.

[53 FR 23872, June 24, 1988, as amended at 84 FR 71814, Dec. 30, 2019]

**§ 878.4590 Focused ultrasound stimulator system for aesthetic use.**

(a) *Identification.* A Focused Ultrasound Stimulator System for Aesthetic Use is a device using focused ultrasound to produce localized, mechanical motion within tissues and cells for the purpose of producing either localized heating for tissue coagulation or for mechanical cellular membrane disruption intended for noninvasive aesthetic use.

(b) *Classification.* Class II (special controls). The special control for this device is FDA’s “Class II Special Controls Guidance Document: Focused Ultrasound Stimulator System for Aesthetic Use.” See § 878.1(e) for the availability of this guidance document.

[76 FR 43121, July 20, 2011]

**§ 878.4630 Ultraviolet lamp for dermatologic disorders.**

(a) *Identification.* An ultraviolet lamp for dermatologic disorders is a device (including a fixture) intended to provide ultraviolet radiation of the body to photoactivate a drug in the treatment of a dermatologic disorder if the labeling of the drug intended for use with the device bears adequate directions for the device’s use with that drug.

(b) *Classification.* Class II.

**§ 878.4635 Sunlamp products and ultraviolet lamps intended for use in sunlamp products.**

(a) *Identification.* A sunlamp product is any device designed to incorporate one or more ultraviolet (UV) lamps intended for irradiation of any part of the living human body, by UV radiation with wavelengths in air between 200 and 400 nanometers, to induce skin tanning. This definition includes tanning beds and tanning booths. A UV

§ 878.4660

21 CFR Ch. I (4–1–20 Edition)

lamp intended for use in sunlamp products is any lamp that produces UV radiation in the wavelength interval of 200 to 400 nanometers in air.

(b) *Classification.* Class II (special controls). The special controls for sunlamp products and UV lamps intended for use in sunlamp products are:

(1) Conduct performance testing that demonstrates the following:

(i) Device meets appropriate output performance specifications such as wavelengths, energy density, and lamp life; and

(ii) Device’s safety features, such as timers to limit UV exposure and alarms, function properly.

(2) Demonstrate that device is mechanically safe to prevent user injury.

(3) Demonstrate software verification, validation, and hazard analysis.

(4) Demonstrate that device is bio-compatible.

(5) Demonstrate that device is electrically safe and electromagnetically compatible in its intended use environment.

(6) *Labeling—(i) Sunlamp products.* (A) The warning statement below must appear on all sunlamp products and must be placed in a black box. This statement must be permanently affixed or inscribed on the product when fully assembled for use so as to be legible and readily accessible to view by the person who will be exposed to UV radiation immediately before the use of the product. It shall be of sufficient durability to remain legible throughout the expected lifetime of the product. It shall appear on a part or panel displayed prominently under normal conditions of use so that it is readily accessible to view whether the tanning bed canopy (or tanning booth door) is open or closed when the person who will be exposed approaches the equipment and the text shall be at least 10 millimeters (height). Labeling on the device must include the following statement:

Attention: This sunlamp product should not be used on persons under the age of 18 years.

(B) Manufacturers shall provide validated instructions on cleaning and disinfection of sunlamp products between uses in the user instructions.

(ii) *Sunlamp products and UV lamps intended for use in sunlamp products.* Manufacturers of sunlamp products and UV lamps intended for use in sunlamp products shall provide or cause to be provided in the user instructions, as well as all consumer-directed catalogs, specification sheets, descriptive brochures, and Web pages in which sunlamp products or UV lamps intended for use in sunlamp products are offered for sale, the following contraindication and warning statements:

(A) “Contraindication: This product is contraindicated for use on persons under the age of 18 years.”

(B) “Contraindication: This product must not be used if skin lesions or open wounds are present.”

(C) “Warning: This product should not be used on individuals who have had skin cancer or have a family history of skin cancer.”

(D) “Warning: Persons repeatedly exposed to UV radiation should be regularly evaluated for skin cancer.”

(c) *Performance standard.* Sunlamp products and UV lamps intended for use in sunlamp products are subject to the electronic product performance standard at § 1040.20 of this chapter.

[79 FR 31213, June 2, 2014]

§ 878.4660 Skin marker.

(a) *Identification.* A skin marker is a pen-like device intended to be used to write on the patient’s skin, e.g., to outline surgical incision sites or mark anatomical sites for accurate blood pressure measurement.

(b) *Classification.* Class I (general controls). The device is exempt from the premarket notification procedures in subpart E of part 807 of this chapter, subject to the limitations in § 878.9.

[53 FR 23872, June 24, 1988, as amended at 59 FR 63010, Dec. 7, 1994; 66 FR 38803, July 25, 2001]

§ 878.4670 Internal tissue marker.

(a) *Identification.* An internal tissue marker is a prescription use device that is intended for use prior to or during general surgical procedures to demarcate selected sites on internal tissues.

(b) *Classification.* Class II (special controls). The special controls for this device are:

(1) The device must be demonstrated to be biocompatible. Material names and specific designation numbers must be provided.

(2) Performance testing must demonstrate that the device performs as intended to mark the tissue for which it is indicated.

(3) Performance data must demonstrate the sterility of the device.

(4) Performance data must support the shelf life of the device by demonstrating sterility, package integrity, device functionality, and material stability over the requested shelf life.

(5) Labeling must include:

(i) A warning that the device must not be used on a non-sterile surface prior to use internally.

(ii) An expiration date/shelf life.

(iii) Single use only labeling must be labeled directly on the device.

[80 FR 46486, Aug. 5, 2015]

**§ 878.4680 Nonpowered, single patient, portable suction apparatus.**

(a) *Identification.* A nonpowered, single patient, portable suction apparatus is a device that consists of a manually operated plastic, disposable evacuation system intended to provide a vacuum for suction drainage of surgical wounds.

(b) *Classification.* Class I (general controls). The device is exempt from the premarket notification procedures in subpart E of part 807 of this chapter subject to § 878.9.

[53 FR 23872, June 24, 1988, as amended at 65 FR 2318, Jan. 14, 2000]

**§ 878.4683 Non-Powered suction apparatus device intended for negative pressure wound therapy.**

(a) *Identification.* A non-powered suction apparatus device intended for negative pressure wound therapy is a device that is indicated for wound management via application of negative pressure to the wound for removal of fluids, including wound exudate, irrigation fluids, and infectious materials. It is further indicated for management of wounds, burns, flaps, and grafts.

(b) *Classification.* Class II (special controls). The special control for this

device is FDA's "Class II Special Controls Guidance Document: Non-powered Suction Apparatus Device Intended for Negative Pressure Wound Therapy (NPWT)." See § 878.1(e) for the availability of this guidance document.

[75 FR 70114, Nov. 17, 2010]

**§ 878.4685 Extracorporeal shock wave device for treatment of chronic wounds.**

(a) *Identification.* An extracorporeal shock wave device for treatment of chronic wounds is a prescription device that focuses acoustic shock waves onto the dermal tissue. The shock waves are generated inside the device and transferred to the body using an acoustic interface.

(b) *Classification.* Class II (special controls). The special controls for this device are:

(1) Non-clinical performance testing must be conducted to demonstrate that the system produces anticipated and reproducible acoustic pressure shock waves.

(2) The patient-contacting components of the device must be demonstrated to be biocompatible.

(3) Performance data must demonstrate that the reusable components of the device can be reprocessed for subsequent use.

(4) Performance data must be provided to demonstrate the electromagnetic compatibility and electrical safety of the device.

(5) Software verification, validation, and hazard analysis must be performed.

(6) Performance data must support the use life of the system by demonstrating continued system functionality over the labeled use life.

(7) Physician labeling must include:

(i) Information on how the device operates and the typical course of treatment;

(ii) A detailed summary of the device's technical parameters;

(iii) Validated methods and instructions for reprocessing of any reusable components; and

(iv) Instructions for preventing hearing loss by use of hearing protection.

(8) Patient labeling must include:

(i) Relevant contraindications, warnings, precautions, adverse effects, and complications;

**§ 878.4700**

**21 CFR Ch. I (4–1–20 Edition)**

(ii) Information on how the device operates and the typical course of treatment;

(iii) The probable risks and benefits associated with the use of the device;

(iv) Post-procedure care instructions; and

(v) Alternative treatments.

[83 FR 9699, Mar. 7, 2018]

**§ 878.4700 Surgical microscope and accessories.**

(a) *Identification.* A surgical microscope and accessories is an AC-powered device intended for use during surgery to provide a magnified view of the surgical field.

(b) *Classification.* Class I (general controls). The device is exempt from the premarket notification procedures in subpart E of part 807 of this chapter, subject to the limitations in § 878.9.

[55 FR 48440, Nov. 20, 1990, as amended at 59 FR 63010, Dec. 7, 1994; 66 FR 38803, July 25, 2001]

**§ 878.4730 Surgical skin degreaser or adhesive tape solvent.**

(a) *Identification.* A surgical skin degreaser or an adhesive tape solvent is a device that consists of a liquid such as 1,1,2-trichloro-1,2,2-trifluoroethane; 1,1,1-trichloroethane; and 1,1,1-trichloroethane with mineral spirits intended to be used to dissolve surface skin oil or adhesive tape.

(b) *Classification.* Class I (general controls). The device is exempt from the premarket notification procedures in subpart E of part 807 of this chapter, subject to the limitations in § 878.9.

[53 FR 23872, June 24, 1988, as amended at 59 FR 63010, Dec. 7, 1994; 66 FR 38803, July 25, 2001]

**§ 878.4750 Implantable staple.**

(a) *Identification.* An implantable staple is a staple-like device intended to connect internal tissues to aid healing. It is not absorbable.

(b) *Classification.* Class II.

**§ 878.4755 Absorbable lung biopsy plug.**

(a) *Identification.* A preformed (polymerized) absorbable lung biopsy plug is intended to provide accuracy in marking a biopsy location for visual-

ization during surgical resection and closure of pleural punctures associated with percutaneous, transthoracic needle lung biopsies. Upon deployment into the biopsy tract, the plug expands to fill the biopsy void and remains in place until resorbed.

(b) *Classification.* Class II (special controls). The special controls for this device are:

(1) The design characteristics of the device must ensure that the geometry and material composition are consistent with the intended use.

(2) Performance testing must demonstrate deployment as indicated in the accompanying labeling, including the indicated introducer needles, and demonstrate expansion and resorption characteristics in a clinically relevant environment.

(3) In vivo evaluation must demonstrate performance characteristics of the device, including the ability of the plug to not prematurely resorb or migrate and the rate of pneumothorax.

(4) Sterility testing must demonstrate the sterility of the device and the effects of the sterilization process on the physical characteristics of the plug.

(5) Shelf-life testing must demonstrate the shelf-life of the device including the physical characteristics of the plug.

(6) The device must be demonstrated to be biocompatible.

(7) Labeling must include a detailed summary of the device-related and procedure-related complications pertinent to the use of the device and appropriate warnings. Labeling must include identification of compatible introducer needles.

[79 FR 13219, Mar. 10, 2014]

**§ 878.4760 Removable skin staple.**

(a) *Identification.* A removable skin staple is a staple-like device intended to connect external tissues temporarily to aid healing. It is not absorbable.

(b) *Classification.* Class I (general controls). The device is exempt from the premarket notification procedures in subpart E of part 807 of this chapter subject to § 878.9.

[53 FR 23872, June 24, 1988, as amended at 65 FR 2318, Jan. 14, 2000]

**§ 878.4780 Powered suction pump.**

(a) *Identification.* A powered suction pump is a portable, AC-powered or compressed air-powered device intended to be used to remove infectious materials from wounds or fluids from a patient's airway or respiratory support system. The device may be used during surgery in the operating room or at the patient's bedside. The device may include a microbial filter.

(b) *Classification.* Class II.

**§ 878.4790 Powered surgical instrument for improvement in the appearance of cellulite.**

(a) *Identification.* A powered surgical instrument for improvement in the appearance of cellulite is a prescription device that is used for the controlled release of subcutaneous tissue for improvement in the appearance of cellulite. The device consists of a cutting tool powered by a motor and a means for instrument guidance to control the areas of subcutaneous tissue cutting underneath the cellulite depressions or dimples.

(b) *Classification.* Class II (special controls). The special controls for this device are:

(1) Non-clinical testing must be performed to demonstrate that the device meets all design specifications and performance requirements, and to demonstrate durability and mechanical integrity of the device.

(2) In vivo evaluation of the device must demonstrate device performance, including the safety of the release methodology and blood loss at the treatment sites.

(3) All elements of the device that may contact the patient must be demonstrated to be biocompatible.

(4) Electrical safety and electromagnetic compatibility of the device must be demonstrated.

(5) The labeling must include a summary of in vivo evaluation data and all the device specific warnings, precautions, and/or contraindications.

(6) Sterility and shelf-life testing for the device must demonstrate the sterility of patient contacting components and the shelf life of these components.

[79 FR 31861, June 3, 2014]

**§ 878.4800 Manual surgical instrument for general use.**

(a) *Identification.* A manual surgical instrument for general use is a non-powered, hand-held, or hand-manipulated device, either reusable or disposable, intended to be used in various general surgical procedures. The device includes the applicator, clip applicator, biopsy brush, manual dermabrasion brush, scrub brush, cannula, ligature carrier, chisel, clamp, contractor, curette, cutter, dissector, elevator, skin graft expander, file, forceps, gouge, instrument guide, needle guide, hammer, hemostat, amputation hook, ligature passing and knot-tying instrument, knife, blood lancet, mallet, disposable or reusable aspiration and injection needle, disposable or reusable suturing needle, osteotome, pliers, rasp, retractor, retractor, saw, scalpel blade, scalpel handle, one-piece scalpel, snare, spatula, stapler, disposable or reusable stripper, stylet, suturing apparatus for the stomach and intestine, measuring tape, and calipers. A surgical instrument that has specialized uses in a specific medical specialty is classified in separate regulations in parts 868 through 892.

(b) *Classification.* Class I (general controls). The device is exempt from the premarket notification procedures in subpart E of part 807 of this chapter, subject to the limitations in § 878.9.

[53 FR 23872, June 24, 1988, as amended at 54 FR 13828, Apr. 5, 1989; 59 FR 63010, Dec. 7, 1994; 66 FR 38803, July 25, 2001]

**§ 878.4810 Laser surgical instrument for use in general and plastic surgery and in dermatology.**

(a) *Identification.* (1) A carbon dioxide laser for use in general surgery and in dermatology is a laser device intended to cut, destroy, or remove tissue by light energy emitted by carbon dioxide.

(2) An argon laser for use in dermatology is a laser device intended to destroy or coagulate tissue by light energy emitted by argon.

(b) *Classification.* (1) Class II.

(2) Class I for special laser gas mixtures used as a lasing medium for this class of lasers. The devices subject to this paragraph (b)(2) are exempt from the premarket notification procedures

## § 878.4815

## 21 CFR Ch. I (4–1–20 Edition)

in subpart E of part 807 of this chapter, subject to the limitations in § 878.9.

[53 FR 23872, June 24, 1988, as amended at 61 FR 1123, Jan. 16, 1996; 66 FR 38803, July 25, 2001]

### § 878.4815 **Magnetic surgical instrument system.**

(a) *Identification.* A magnetic surgical instrument system is a prescription device used in laparoscopic surgical procedures consisting of several components, such as surgical instruments, and a magnetic controller. The magnetic controller is provided separately from the surgical instrument and is used outside the patient. The external magnetic controller is magnetically coupled with the internal surgical instrument(s) at the surgical site to grasp, hold, retract, mobilize, or manipulate soft tissue and organs.

(b) *Classification.* Class II (special controls). The special controls for this device are:

(1) In vivo performance data must demonstrate that the device performs as intended under anticipated conditions of use. Testing must demonstrate the ability of the device to grasp, hold, retract, mobilize, or manipulate soft tissue and organs.

(2) Non-clinical performance data must demonstrate that the system performs as intended under anticipated conditions of use. The following performance characteristics must be tested:

(i) Magnetic field strength testing characterization to identify the distances from the magnet that are safe for patients and users with ferromagnetic implants, devices, or objects.

(ii) Ability of the internal surgical instrument(s) to be coupled, decoupled, and re-coupled with the external magnet over the external magnet use life.

(3) The patient-contacting components of the device must be demonstrated to be biocompatible.

(4) Performance data must demonstrate the sterility of the device components that are patient-contacting.

(5) Methods and instructions for reprocessing reusable components must be validated.

(6) Performance data must support shelf life by demonstrating continued sterility of the device or the sterile components and device functionality over the labeled shelf life.

(7) Training must be developed and validated by human factors testing and analysis to ensure users can follow the instructions for use to allow safe use of the device.

(8) Labeling must include:

(i) Magnetic field safe zones.

(ii) Instructions for proper device use.

(iii) A screening checklist to ensure that all patients and operating staff are screened from bringing ferromagnetic implants, devices, or objects near the external magnet.

(iv) Reprocessing instructions for any reusable components.

(v) Shelf life.

(vi) Use life.

[81 FR 64763, Sept. 21, 2016]

### § 878.4820 **Surgical instrument motors and accessories/attachments.**

(a) *Identification.* Surgical instrument motors and accessories are AC-powered, battery-powered, or air-powered devices intended for use during surgical procedures to provide power to operate various accessories or attachments to cut hard tissue or bone and soft tissue. Accessories or attachments may include a bur, chisel (osteotome), dermabrasion brush, dermatome, drill bit, hammerhead, pin driver, and saw blade.

(b) *Classification.* Class I (general controls). The device is exempt from the premarket notification procedures in subpart E of part 807 of this chapter subject to § 878.9.

[55 FR 48440, Nov. 20, 1990, as amended at 65 FR 2318, 2000]

### § 878.4830 **Absorbable surgical gut suture.**

(a) *Identification.* An absorbable surgical gut suture, both plain and chromic, is an absorbable, sterile, flexible thread prepared from either the serosal connective tissue layer of beef (bovine) or the submucosal fibrous tissue of sheep (ovine) intestine, and is intended for use in soft tissue approximation.

(b) *Classification.* Class II (special controls). The special control for this



device is FDA's "Class II Special Controls Guidance Document: Surgical Sutures; Guidance for Industry and FDA." See § 878.1(e) for the availability of this guidance document.

[54 FR 50738, Dec. 11, 1989, as amended at 68 FR 32984, June 3, 2003]

**§ 878.4840 Absorbable polydioxanone surgical suture.**

(a) *Identification.* An absorbable polydioxanone surgical suture is an absorbable, flexible, sterile, monofilament thread prepared from polyester polymer poly (p-dioxanone) and is intended for use in soft tissue approximation, including pediatric cardiovascular tissue where growth is expected to occur, and ophthalmic surgery. It may be coated or uncoated, undyed or dyed, and with or without a standard needle attached.

(b) *Classification.* Class II (special controls). The special control for the device is FDA's "Class II Special Controls Guidance Document: Surgical Sutures; Guidance for Industry and FDA." See § 878.1(e) for the availability of this guidance document.

[67 FR 77676, Dec. 19, 2002]

**§ 878.4860 Light based energy source device for topical application.**

(a) *Identification.* The device emits light energy at near infrared spectrum and is applied externally to the surface of herpes simplex labialis lesions on or around the lips.

(b) *Classification.* Class II (special controls). The special controls for this device are:

(1) The technical parameters of the device, including wavelength, treatment time, treatment area, energy density, spot size, and power, must be characterized.

(2) The cleaning and disinfection instructions for the device must be validated.

(3) The device must be demonstrated to be biocompatible.

(4) Performance testing must validate electromagnetic compatibility (EMC), ocular safety, and electrical safety of the device.

(5) Labeling must direct end-users to contact the device manufacturer and

MedWatch if they experience any adverse events when using this device.

(6) Labeling must include specific information pertinent to use of the device by the intended patient population and the treatment regimen.

(7) Simulated use testing must include information from a usability, label comprehension and self-selection study to demonstrate that the device can be used by the intended patient population without any assistance.

(8) Clinical data must show adequate reduction in time to healing and assess risks of redness, discomfort, burns, and blisters.

[83 FR 52969, Oct. 19, 2018]

**§ 878.4930 Suture retention device.**

(a) *Identification.* A suture retention device is a device, such as a retention bridge, a surgical button, or a suture bolster, intended to aid wound healing by distributing suture tension over a larger area in the patient.

(b) *Classification.* Class I (general controls). The device is exempt from the premarket notification procedures in subpart E of part 807 of this chapter, subject to the limitations in § 878.9.

[53 FR 23872, June 24, 1988, as amended at 59 FR 63010, Dec. 7, 1994; 66 FR 38803, July 25, 2001]

**§ 878.4950 Manual operating table and accessories and manual operating chair and accessories.**

(a) *Identification.* A manual operating table and accessories and a manual operating chair and accessories are non-powered devices, usually with movable components, intended to be used to support a patient during diagnostic examinations or surgical procedures.

(b) *Classification.* Class I (general controls). The device is exempt from the premarket notification procedures in subpart E of part 807 of this chapter, subject to the limitations in § 878.9.

[53 FR 23872, June 24, 1988, as amended at 54 FR 13828, Apr. 5, 1989; 59 FR 63010, Dec. 7, 1994; 66 FR 38803, July 25, 2001]

**§ 878.4960 Operating tables and accessories and operating chairs and accessories.**

(a) *Identification.* Operating tables and accessories and operating chairs

**§ 878.5000**

**21 CFR Ch. I (4–1–20 Edition)**

and accessories are AC-powered or air-powered devices, usually with movable components, intended for use during diagnostic examinations or surgical procedures to support and position a patient.

(b) *Classification.* Class I (general controls). The device is exempt from the premarket notification procedures in subpart E of part 807 of this chapter subject to § 878.9.

[55 FR 48440, Nov. 20, 1990, as amended at 65 FR 2318, Jan. 14, 2000]

**§ 878.5000 Nonabsorbable poly(ethylene terephthalate) surgical suture.**

(a) *Identification.* Nonabsorbable poly(ethylene terephthalate) surgical suture is a multifilament, nonabsorbable, sterile, flexible thread prepared from fibers of high molecular weight, long-chain, linear polyesters having recurrent aromatic rings as an integral component and is indicated for use in soft tissue approximation. The poly(ethylene terephthalate) surgical suture meets U.S.P. requirements as described in the U.S.P. Monograph for Nonabsorbable Surgical Sutures; it may be provided uncoated or coated; and it may be undyed or dyed with an appropriate FDA listed color additive. Also, the suture may be provided with or without a standard needle attached.

(b) *Classification.* Class II (special controls). The special control for this device is FDA's "Class II Special Controls Guidance Document: Surgical Sutures; Guidance for Industry and FDA." See § 878.1(e) for the availability of this guidance document.

[56 FR 24685, May 31, 1991, as amended at 68 FR 32984, June 3, 2003]

**§ 878.5010 Nonabsorbable polypropylene surgical suture.**

(a) *Identification.* Nonabsorbable polypropylene surgical suture is a monofilament, nonabsorbable, sterile, flexible thread prepared from long-chain polyolefin polymer known as polypropylene and is indicated for use in soft tissue approximation. The polypropylene surgical suture meets United States Pharmacopeia (U.S.P.) requirements as described in the U.S.P. Monograph for Nonabsorbable Surgical Sutures; it may be undyed or dyed with

an FDA approved color additive; and the suture may be provided with or without a standard needle attached.

(b) *Classification.* Class II (special controls). The special control for this device is FDA's "Class II Special Controls Guidance Document: Surgical Sutures; Guidance for Industry and FDA." See § 878.1(e) for the availability of this guidance document.

[56 FR 24685, May 31, 1991, as amended at 68 FR 32984, June 3, 2003]

**§ 878.5020 Nonabsorbable polyamide surgical suture.**

(a) *Identification.* Nonabsorbable polyamide surgical suture is a nonabsorbable, sterile, flexible thread prepared from long-chain aliphatic polymers Nylon 6 and Nylon 6,6 and is indicated for use in soft tissue approximation. The polyamide surgical suture meets United States Pharmacopeia (U.S.P.) requirements as described in the U.S.P. monograph for nonabsorbable surgical sutures; it may be monofilament or multifilament in form; it may be provided uncoated or coated; and it may be undyed or dyed with an appropriate FDA listed color additive. Also, the suture may be provided with or without a standard needle attached.

(b) *Classification.* Class II (special controls). The special control for this device is FDA's "Class II Special Controls Guidance Document: Surgical Sutures; Guidance for Industry and FDA." See § 878.1(e) for the availability of this guidance document.

[56 FR 24685, May 31, 1991, as amended at 68 FR 32985, June 3, 2003]

**§ 878.5030 Natural nonabsorbable silk surgical suture.**

(a) *Identification.* Natural nonabsorbable silk surgical suture is a nonabsorbable, sterile, flexible multifilament thread composed of an organic protein called fibroin. This protein is derived from the domesticated species *Bombyx mori* (*B. mori*) of the family *Bombycidae*. Natural nonabsorbable silk surgical suture is indicated for use in soft tissue approximation. Natural nonabsorbable silk surgical suture meets the United States Pharmacopeia (U.S.P.) monograph requirements for Nonabsorbable Surgical Suture (class I). Natural nonabsorbable silk surgical

suture may be braided or twisted; it may be provided uncoated or coated; and it may be undyed or dyed with an FDA listed color additive.

(b) *Classification.* Class II (special controls). The special control for this device is FDA's "Class II Special Controls Guidance Document: Surgical Sutures; Guidance for Industry and FDA." See § 878.1(e) for the availability of this guidance document.

[58 FR 57558, Oct. 26, 1993, as amended at 68 FR 32985, June 3, 2003]

**§ 878.5035 Nonabsorbable expanded polytetrafluoroethylene surgical suture.**

(a) *Identification.* Nonabsorbable expanded polytetrafluoroethylene (ePTFE) surgical suture is a monofilament, nonabsorbable, sterile, flexible thread prepared from ePTFE and is intended for use in soft tissue approximation and ligation, including cardiovascular surgery. It may be undyed or dyed with an approved color additive and may be provided with or without an attached needle(s).

(b) *Classification.* Class II (special controls). The special control for this device is FDA's "Class II Special Controls Guidance Document: Surgical Sutures; Guidance for Industry and FDA." See § 878.1(e) for the availability of this guidance document.

[65 FR 20735, Apr. 18, 2000, as amended at 68 FR 32985, June 3, 2003]

**§ 878.5040 Suction lipoplasty system.**

(a) *Identification.* A suction lipoplasty system is a device intended for aesthetic body contouring. The device consists of a powered suction pump (containing a microbial filter on the exhaust and a microbial in-line filter in the connecting tubing between the collection bottle and the safety trap), collection bottle, cannula, and connecting tube. The microbial filters, tubing, collection bottle, and cannula must be capable of being changed between patients. The powered suction pump has a motor with a minimum of 1/3 horsepower, a variable vacuum range from 0 to 29.9 inches of mercury, vacuum control valves to regulate the vacuum with accompanying vacuum gauges, a single or double rotary vane (with or without oil), a single or double

diaphragm, a single or double piston, and a safety trap.

(b) *Classification.* Class II (special controls). Consensus standards and labeling restrictions.

[63 FR 7705, Feb. 17, 1998]

**§ 878.5050 Surgical smoke precipitator.**

(a) *Identification.* A surgical smoke precipitator is a prescription device intended for clearance of the visual field by precipitation of surgical smoke and other aerosolized particulate matter created during laparoscopic surgery.

(b) *Classification.* Class II (special controls). The special controls for this device are:

(1) Adverse tissue reaction must be mitigated through the following:

(i) Chemical characterization and toxicological risk assessment of the treated surgical smoke.

(ii) Demonstration that the elements of the device that may contact the patient are biocompatible.

(2) Electrical safety and electromagnetic compatibility testing must demonstrate that the device performs as intended.

(3) Software verification, validation, and hazard analysis must be performed.

(4) Performance data must demonstrate the sterility of the patient contacting components of the device.

(5) Performance data must support the shelf life of the sterile components of the device by demonstrating continued functionality, sterility, and package integrity over the identified shelf life.

(6) Animal simulated-use testing must demonstrate that the device performs as intended under anticipated conditions of use. The following performance characteristics must be tested:

(i) Device must be demonstrated to be effectively inserted, positioned, and removed from the site of use.

(ii) Device must be demonstrated to precipitate surgical smoke particulates to clear the visual field for laparoscopic surgeries.

(iii) Device must be demonstrated to be non-damaging to the site of use and animal subject.

(7) Labeling must identify the following:

(i) Detailed instructions for use.

## § 878.5070

- (ii) Electrical safety and electromagnetic compatibility information.
- (iii) A shelf life.

[83 FR 4143, Jan. 30, 2018]

### Subpart F—Therapeutic Devices

#### § 878.5070 Air-handling apparatus for a surgical operating room.

(a) *Identification.* Air-handling apparatus for a surgical operating room is a device intended to produce a directed, nonturbulent flow of air that has been filtered to remove particulate matter and microorganisms to provide an area free of contaminants to reduce the possibility of infection in the patient.

(b) *Classification.* Class II (special controls). The device, when it is an air handling bench apparatus, an air handling room apparatus, or an air handling enclosure apparatus, is exempt from the premarket notification procedures in subpart E of part 807 of this chapter subject to the limitations in § 878.9.

[53 FR 23872, June 24, 1988, as amended at 84 FR 71814, Dec. 30, 2019]

#### § 878.5080 Air-handling apparatus accessory.

(a) *Identification.* An air-handling apparatus accessory is a supplementary device that is intended to be used with an air-handling apparatus for a surgical operating room. This device provides an interface between the components of the device or can be used to switch electrical power. This generic type of device includes fittings, adapters, couplers, remote switches, and footswitches.

(b) *Classification.* Class I (general controls). The device is exempt from the premarket notification procedures in subpart E of part 807 of this chapter subject to the limitations in § 878.9.

[84 FR 14870, Apr. 12, 2019]

#### § 878.5350 Needle-type epilator.

(a) *Identification.* A needle-type epilator is a device intended to destroy the dermal papilla of a hair by applying electric current at the tip of a fine needle that has been inserted close to the hair shaft, under the skin, and into the dermal papilla. The electric current may be high-frequency AC current,

## 21 CFR Ch. I (4–1–20 Edition)

high-frequency AC combined with DC current, or DC current only.

(b) *Classification.* Class I (general controls). The device is exempt from the premarket notification procedures in subpart E of part 807 of this chapter, subject to the limitations in § 878.9.

[53 FR 23872, June 24, 1988, as amended at 61 FR 1123, Jan. 16, 1996; 66 FR 38803, July 25, 2001]

#### § 878.5360 Tweezer-type epilator.

(a) *Identification.* The tweezer-type epilator is an electrical device intended to remove hair. The energy provided at the tip of the tweezer used to remove hair may be radio frequency, galvanic (direct current), or a combination of radio frequency and galvanic energy.

(b) *Classification.* Class I (general controls). The device is exempt from premarket notification procedures in subpart E of part 807 of this chapter subject to § 878.9.

[63 FR 57060, Oct. 26, 1998]

#### § 878.5400 Low level laser system for aesthetic use

(a) *Identification.* A Low Level Laser System for Aesthetic Use is a device using low level laser energy for the disruption of adipocyte cells within the fat layer for the release of fat and lipids from these cells for noninvasive aesthetic use.

(b) *Classification.* Class II (special controls). The special control for this device is the FDA guidance document entitled “Guidance for Industry and Food and Drug Administration Staff; Class II Special Controls Guidance Document: Low Level Laser System for Aesthetic Use.” See § 878.1(e) for the availability of this guidance document.

[76 FR 20842, Apr. 14, 2011]

#### § 878.5650 Topical oxygen chamber for extremities.

(a) *Identification.* A topical oxygen chamber for extremities is a device that is intended to surround a patient’s limb and apply humidified oxygen topically at a pressure slightly greater than atmospheric pressure to aid healing of chronic skin ulcers such as bedsores.

(b) *Classification.* Class II (special controls). The special control for this

device is FDA's "Class II Special Controls Guidance: Topical Oxygen Chamber for Extremities." See §878.1(e) for the availability of this guidance document.

[76 FR 22807, Apr. 25, 2011]

**§ 878.5900 Nonpneumatic tourniquet.**

(a) *Identification.* A nonpneumatic tourniquet is a device consisting of a strap or tubing intended to be wrapped around a patient's limb and tightened to reduce circulation.

(b) *Classification.* Class I (general controls). The device is exempt from the premarket notification procedures in subpart E of part 807 of this chapter, subject to the limitations in §878.9.

[53 FR 23872, June 24, 1988, as amended at 54 FR 13828, Apr. 5, 1989; 59 FR 63010, Dec. 7, 1994; 66 FR 38803, July 25, 2001]

**§ 878.5910 Pneumatic tourniquet.**

(a) *Identification.* A pneumatic tourniquet is an air-powered device consisting of a pressure-regulating unit, connecting tubing, and an inflatable cuff. The cuff is intended to be wrapped around a patient's limb and inflated to reduce or totally occlude circulation during surgery.

(b) *Classification.* Class I (general controls). The device is exempt from the premarket notification procedures in subpart E of part 807 of this chapter, subject to the limitations in §878.9.

[53 FR 23872, June 24, 1988, as amended at 61 FR 1123, Jan. 16, 1996; 66 FR 38803, July 25, 2001]

**PART 880—GENERAL HOSPITAL AND PERSONAL USE DEVICES**

**Subpart A—General Provisions**

Sec.

880.1 Scope.

880.3 Effective dates of requirement for premarket approval.

880.9 Limitations of exemptions from section 510(k) of the Federal Food, Drug, and Cosmetic Act (the act).

**Subpart B [Reserved]**

**Subpart C—General Hospital and Personal Use Monitoring Devices**

880.2200 Liquid crystal forehead temperature strip.

880.2400 Bed-patient monitor.  
 880.2420 Electronic monitor for gravity flow infusion systems.  
 880.2460 Electrically powered spinal fluid pressure monitor.  
 880.2500 Spinal fluid manometer.  
 880.2700 Stand-on patient scale.  
 880.2720 Patient scale.  
 880.2740 Surgical sponge scale.  
 880.2750 Image processing device for estimation of external blood loss.  
 880.2800 Sterilization process indicator.  
 880.2900 Clinical color change thermometer.  
 880.2910 Clinical electronic thermometer.  
 880.2920 Clinical mercury thermometer.  
 880.2930 Apgar timer.

**Subparts D–E [Reserved]**

**Subpart F—General Hospital and Personal Use Therapeutic Devices**

880.5025 I.V. container.  
 880.5045 Medical recirculating air cleaner.  
 880.5075 Elastic bandage.  
 880.5090 Liquid bandage.  
 880.5100 AC-powered adjustable hospital bed.  
 880.5110 Hydraulic adjustable hospital bed.  
 880.5120 Manual adjustable hospital bed.  
 880.5130 Infant radiant warmer.  
 880.5140 Pediatric medical crib.  
 880.5145 Medical bassinets.  
 880.5150 Nonpowered flotation therapy mattress.  
 880.5160 Therapeutic medical binder.  
 880.5180 Burn sheet.  
 880.5200 Intravascular catheter.  
 880.5210 Intravascular catheter securement device.  
 880.5240 Medical adhesive tape and adhesive bandage.  
 880.5270 Neonatal eye pad.  
 880.5300 Medical absorbent fiber.  
 880.5400 Neonatal incubator.  
 880.5410 Neonatal transport incubator.  
 880.5420 Pressure infuser for an I.V. bag.  
 880.5430 Nonelectrically powered fluid injector.  
 880.5440 Intravascular administration set.  
 880.5445 Intravascular administration set, automated air removal system.  
 880.5450 Patient care reverse isolation chamber.  
 880.5475 Jet lavage.  
 880.5500 AC-powered patient lift.  
 880.5510 Non-AC-powered patient lift.  
 880.5550 Alternating pressure air flotation mattress.  
 880.5560 Temperature regulated water mattress.  
 880.5570 Hypodermic single lumen needle.  
 880.5580 Acupuncture needle.  
 880.5630 Nipple shield.  
 880.5640 Lamb feeding nipple.  
 880.5680 Pediatric position holder.  
 880.5700 Neonatal phototherapy unit.  
 880.5725 Infusion pump.

## § 880.1

## 21 CFR Ch. I (4–1–20 Edition)

880.5740 Suction snakebite kit.  
880.5760 Chemical cold pack snakebite kit.  
880.5780 Medical support stocking.  
880.5820 Therapeutic scrotal support.  
880.5860 Piston syringe.  
880.5950 Umbilical occlusion device.  
880.5960 Lice removal kit.  
880.5965 Subcutaneous, implanted,  
intravascular infusion port and catheter.  
880.5970 Percutaneous, implanted, long-term  
intravascular catheter.

### Subpart G—General Hospital and Personal Use Miscellaneous Devices

880.6025 Absorbent tipped applicator.  
880.6050 Ice bag.  
880.6060 Medical disposable bedding.  
880.6070 Bed board.  
880.6080 Cardiopulmonary resuscitation  
board.  
880.6085 Hot/cold water bottle.  
880.6100 Ethylene oxide gas aerator cabinet.  
880.6140 Medical chair and table.  
880.6150 Ultrasonic cleaner for medical in-  
struments.  
880.6175 [Reserved]  
880.6185 Cast cover.  
880.6190 Mattress cover for medical pur-  
poses.  
880.6200 Ring cutter.  
880.6210 Sharps needle destruction device.  
880.6230 Tongue depressor.  
880.6250 Non-powdered patient examination  
glove.  
880.6260 Filtering facepiece respirator for  
use by the general public in public health  
medical emergencies.  
880.6265 Examination gown.  
880.6280 Medical insole.  
880.6300 Implantable radiofrequency trans-  
ponder system for patient identification  
and health information.  
880.6305 Ingestible event marker.  
880.6310 Medical device data system.  
880.6315 Remote medication management  
system.  
880.6320 AC-powered medical examination  
light.  
880.6350 Battery-powered medical examina-  
tion light.  
880.6375 Patient lubricant.  
880.6430 Liquid medication dispenser.  
880.6450 Skin pressure protectors.  
880.6500 Medical ultraviolet air purifier.  
880.6600 Ultraviolet (UV) radiation chamber  
disinfection device.  
880.6710 Medical ultraviolet water purifier.  
880.6730 Body waste receptacle.  
880.6740 Vacuum-powered body fluid suction  
apparatus.  
880.6760 Protective restraint.  
880.6775 Powered patient transfer device.  
880.6785 Manual patient transfer device.  
880.6800 Washers for body waste receptacles.  
880.6820 Medical disposable scissors.  
880.6850 Sterilization wrap.

880.6860 Ethylene oxide gas sterilizer.  
880.6870 Dry-heat sterilizer.  
880.6880 Steam sterilizer.  
880.6885 Liquid chemical sterilants/high  
level disinfectants.  
880.6890 General purpose disinfectants.  
880.6900 Hand-carried stretcher.  
880.6910 Wheeled stretcher.  
880.6920 Syringe needle introducer.  
880.6960 Irrigating syringe.  
880.6970 Liquid crystal vein locator.  
880.6980 Vein stabilizer.  
880.6990 Infusion stand.  
880.6991 Medical washer.  
880.6992 Medical washer-disinfector.

AUTHORITY: 21 U.S.C. 351, 360, 360c, 360e,  
360j, 360l, 371.

SOURCE: 45 FR 69682, Oct. 21, 1980, unless  
otherwise noted.

EDITORIAL NOTE: Nomenclature changes to  
part 880 appear at 73 FR 35341, June 23, 2008.

### Subpart A—General Provisions

#### § 880.1 Scope.

(a) This part sets forth the classifica-  
tion of general hospital and personal  
use devices intended for human use  
that are in commercial distribution.

(b) The identification of a device in a  
regulation in this part is not a precise  
description of every device that is, or  
will be, subject to the regulation. A  
manufacturer who submits a pre-  
market notification submission for a  
device under part 807 may not show  
merely that the device is accurately  
described by the section title and iden-  
tification provisions of a regulation in  
this part, but shall state why the de-  
vice is substantially equivalent to  
other devices, as required by § 807.87.

(c) To avoid duplicative listings, a  
general hospital and personal use de-  
vice that has two or more types of uses  
(e.g., used both as a diagnostic device  
and as a therapeutic device) is listed  
only in one subpart.

(d) References in this part to regu-  
latory sections of the Code of Federal  
Regulations are to chapter I of title 21,  
unless otherwise noted.

(e) Guidance documents referenced in  
this part are available on the Internet  
at [http://www.fda.gov/MedicalDevices/  
DeviceRegulationandGuidance/  
GuidanceDocuments/default.htm](http://www.fda.gov/MedicalDevices/DeviceRegulationandGuidance/GuidanceDocuments/default.htm).

[52 FR 17738, May 11, 1987, as amended at 69  
FR 71704, Dec. 8, 2004; 78 FR 18233, Mar. 26,  
2013]

**§ 880.3 Effective dates of requirement for premarket approval.**

A device included in this part that is classified into class III (premarket approval) shall not be commercially distributed after the date shown in the regulation classifying the device unless the manufacturer has an approval under section 515 of the act (unless an exemption has been granted under section 520(g)(2) of the act). An approval under section 515 of the act consists of FDA's issuance of an order approving an application for premarket approval (PMA) for the device or declaring completed a product development protocol (PDP) for the device.

(a) Before FDA requires that a device commercially distributed before the enactment date of the amendments, or a device that has been found substantially equivalent to such a device, has an approval under section 515 of the act FDA must promulgate a regulation under section 515(b) of the act requiring such approval, except as provided in paragraph (b) of this section. Such a regulation under section 515(b) of the act shall not be effective during the grace period ending on the 90th day after its promulgation or on the last day of the 30th full calendar month after the regulation that classifies the device into class III is effective, whichever is later. See section 501(f)(2)(B) of the act. Accordingly, unless an effective date of the requirement for premarket approval is shown in the regulation for a device classified into class III in this part, the device may be commercially distributed without FDA's issuance of an order approving a PMA or declaring completed a PDP for the device. If FDA promulgates a regulation under section 515(b) of the act requiring premarket approval for a device, section 501(f)(1)(A) of the act applies to the device.

(b) Any new, not substantially equivalent, device introduced into commercial distribution on or after May 28, 1976, including a device formerly marketed that has been substantially altered, is classified by statute (section 513(f) of the act) into class III without any grace period and FDA must have issued an order approving a PMA or declaring completed a PDP for the device before the device is commercially dis-

tributed unless it is reclassified. If FDA knows that a device being commercially distributed may be a "new" device defined in this section because of any new intended use or other reasons, FDA may codify the statutory classification of the device into class III for such new use. Accordingly, the regulation for such a class III device states that as of the enactment date of the amendments, May 28, 1976, the device must have an approval under section 515 of the act before commercial distribution.

[52 FR 17738, May 11, 1987]

**§ 880.9 Limitations of exemptions from section 510(k) of the Federal Food, Drug, and Cosmetic Act (the act).**

The exemption from the requirement of premarket notification (section 510(k) of the act) for a generic type of class I or II device is only to the extent that the device has existing or reasonably foreseeable characteristics of commercially distributed devices within that generic type or, in the case of in vitro diagnostic devices, only to the extent that misdiagnosis as a result of using the device would not be associated with high morbidity or mortality. Accordingly, manufacturers of any commercially distributed class I or II device for which FDA has granted an exemption from the requirement of premarket notification must still submit a premarket notification to FDA before introducing or delivering for introduction into interstate commerce for commercial distribution the device when:

(a) The device is intended for a use different from the intended use of a legally marketed device in that generic type of device; e.g., the device is intended for a different medical purpose, or the device is intended for lay use where the former intended use was by health care professionals only;

(b) The modified device operates using a different fundamental scientific technology than a legally marketed device in that generic type of device; e.g., a surgical instrument cuts tissue with a laser beam rather than with a sharpened metal blade, or an in vitro diagnostic device detects or identifies infectious agents by using deoxyribonucleic acid (DNA) probe or

## § 880.2200

nucleic acid hybridization technology rather than culture or immunoassay technology; or

(c) The device is an in vitro device that is intended:

(1) For use in the diagnosis, monitoring, or screening of neoplastic diseases with the exception of immunohistochemical devices;

(2) For use in screening or diagnosis of familial or acquired genetic disorders, including inborn errors of metabolism;

(3) For measuring an analyte that serves as a surrogate marker for screening, diagnosis, or monitoring life-threatening diseases such as acquired immune deficiency syndrome (AIDS), chronic or active hepatitis, tuberculosis, or myocardial infarction or to monitor therapy;

(4) For assessing the risk of cardiovascular diseases;

(5) For use in diabetes management;

(6) For identifying or inferring the identity of a microorganism directly from clinical material;

(7) For detection of antibodies to microorganisms other than immunoglobulin G (IgG) or IgG assays when the results are not qualitative, or are used to determine immunity, or the assay is intended for use in matrices other than serum or plasma;

(8) For noninvasive testing as defined in § 812.3(k) of this chapter; and

(9) For near patient testing (point of care).

[65 FR 2318, Jan. 14, 2000]

### Subpart B [Reserved]

### Subpart C—General Hospital and Personal Use Monitoring Devices

#### § 880.2200 Liquid crystal forehead temperature strip.

(a) *Identification.* A liquid crystal forehead temperature strip is a device applied to the forehead that is used to indicate the presence or absence of fever, or to monitor body temperature changes. The device displays the color changes of heat sensitive liquid crystals corresponding to the variation in the surface temperature of the skin. The liquid crystals, which are cholesteric esters, are sealed in plastic.

## 21 CFR Ch. I (4–1–20 Edition)

(b) *Classification.* Class II (special controls). The device is exempt from the premarket notification procedures in subpart E of part 807 of this chapter subject to § 880.9.

[45 FR 69682, Oct. 21, 1980, as amended at 63 FR 59228, Nov. 3, 1998]

#### § 880.2400 Bed-patient monitor.

(a) *Identification.* A bed-patient monitor is a battery-powered device placed under a mattress and used to indicate by an alarm or other signal when a patient attempts to leave the bed.

(b) *Classification.* Class I (general controls). The device is exempt from the premarket notification procedures in subpart E of part 807 of this chapter subject to the limitations in § 880.9.

[45 FR 69682, Oct. 21, 1980, as amended at 59 FR 63010, Dec. 7, 1994; 66 FR 38803, July 25, 2001]

#### § 880.2420 Electronic monitor for gravity flow infusion systems.

(a) *Identification.* An electronic monitor for gravity flow infusion systems is a device used to monitor the amount of fluid being infused into a patient. The device consists of an electronic transducer and equipment for signal amplification, conditioning, and display.

(b) *Classification.* Class II (performance standards).

#### § 880.2460 Electrically powered spinal fluid pressure monitor.

(a) *Identification.* An electrically powered spinal fluid pressure monitor is an electrically powered device used to measure spinal fluid pressure by the use of a transducer which converts spinal fluid pressure into an electrical signal. The device includes signal amplification, conditioning, and display equipment.

(b) *Classification.* Class II (performance standards).

#### § 880.2500 Spinal fluid manometer.

(a) *Identification.* A spinal fluid manometer is a device used to measure spinal fluid pressure. The device uses a hollow needle, which is inserted into



the spinal column fluid space, to connect the spinal fluid to a graduated column so that the pressure can be measured by reading the height of the fluid.

(b) *Classification.* Class II (performance standards).

**§ 880.2700 Stand-on patient scale.**

(a) *Identification.* A stand-on patient scale is a device intended for medical purposes that is used to weigh a patient who is able to stand on the scale platform.

(b) *Classification.* Class I (general controls). The device is exempt from the premarket notification procedures in subpart E of part 807 of this chapter, subject to the limitations in § 880.9. The device also is exempt from the current good manufacturing practice requirements of the quality system regulation in part 820 of this chapter, with the exception of § 820.180, with respect to general requirements concerning records, and § 820.198, with respect to complaint files.

[45 FR 69682, Oct. 21, 1980, as amended at 66 FR 38803, July 25, 2001]

**§ 880.2720 Patient scale.**

(a) *Identification.* A patient scale is a device intended for medical purposes that is used to measure the weight of a patient who cannot stand on a scale. This generic device includes devices placed under a bed or chair to weigh both the support and the patient, devices where the patient is lifted by a sling from a bed to be weighed, and devices where the patient is placed on the scale platform to be weighed. The device may be mechanical, battery powered, or AC-powered and may include transducers, electronic signal amplification, conditioning and display equipment.

(b) *Classification.* Class I (general controls). The device is exempt from the premarket notification procedures in subpart E of part 807 of this chapter subject to the limitations in § 880.9.

[45 FR 69682, Oct. 21, 1980, as amended at 61 FR 1123, Jan. 16, 1996; 66 FR 38803, July 25, 2001]

**§ 880.2740 Surgical sponge scale.**

(a) *Identification.* A surgical sponge scale is a nonelectrically powered de-

vice used to weigh surgical sponges that have been used to absorb blood during surgery so that, by comparison with the known dry weight of the sponges, an estimate may be made of the blood lost by the patient during surgery.

(b) *Classification.* Class I (general controls). The device is exempt from the premarket notification procedures in subpart E of part 807 of this chapter, subject to the limitations in § 880.9. The device also is exempt from the current good manufacturing practice requirements of the quality system regulation in part 820 of this chapter, with the exception of § 820.180, with respect to general requirements concerning records, and § 820.198, with respect to complaint files.

[45 FR 69682, Oct. 21, 1980, as amended at 66 FR 38804, July 25, 2001]

**§ 880.2750 Image processing device for estimation of external blood loss.**

(a) *Identification.* An image processing device for estimation of external blood loss is a device to be used as an aid in estimation of patient external blood loss. The device may include software and/or hardware that is used to process images capturing externally lost blood to estimate the hemoglobin mass and/or the blood volume present in the images.

(b) *Classification.* Class II (special controls). The special controls for this device are:

(1) Non-clinical performance data must demonstrate that the device performs as intended under anticipated conditions of use. Demonstration of the performance characteristics must include a comparison to a scientifically valid alternative method for measuring deposited hemoglobin mass. The following use conditions must be tested:

(i) Lighting conditions;  
 (ii) Range of expected hemoglobin concentrations;  
 (iii) Range of expected blood volume absorption; and

(iv) Presence of other non-sanguineous fluids (*e.g.*, saline irrigation fluid).

(2) Human factors testing and analysis must validate that the device design and labeling are sufficient for appropriate use by intended users of the device.

## § 880.2800

(3) Appropriate analysis and non-clinical testing must validate the electromagnetic compatibility (EMC) and wireless performance of the device.

(4) Appropriate software verification, validation, and hazard analysis must be performed.

(5) Software display must include an estimate of the cumulative error associated with estimated blood loss values.

(6) Labeling must include:

(i) Warnings, cautions, and limitations needed for safe use of the device;

(ii) A detailed summary of the performance testing pertinent to use of the device, including a description of the bias and variance the device exhibited during testing;

(iii) The validated surgical materials, range of hemoglobin mass, software, hardware, and accessories that the device is intended to be used with; and

(iv) EMC and wireless technology instructions and information.

[82 FR 60307, Dec. 20, 2017]

## § 880.2800 Sterilization process indicator.

(a) *Biological sterilization process indicator*—(1) *Identification*. A biological sterilization process indicator is a device intended for use by a health care provider to accompany products being sterilized through a sterilization procedure and to monitor adequacy of sterilization. The device consists of a known number of microorganisms, of known resistance to the mode of sterilization, in or on a carrier and enclosed in a protective package. Subsequent growth or failure of the microorganisms to grow under suitable conditions indicates the adequacy of sterilization.

(2) *Classification*. Class II (performance standards).

(b) *Physical/chemical sterilization process indicator*—(1) *Identification*. A physical/chemical sterilization process indicator is a device intended for use by a health care provider to accompany products being sterilized through a sterilization procedure and to monitor one or more parameters of the sterilization process. The adequacy of the sterilization conditions as measured by these parameters is indicated by a visible change in the device.

## 21 CFR Ch. I (4–1–20 Edition)

(2) *Classification*. Class II (performance standards).

## § 880.2900 Clinical color change thermometer.

(a) *Identification*. A clinical color change thermometer is a disposable device used to measure a patient's oral, rectal, or axillary (armpit) body temperature. The device records body temperature by use of heat sensitive chemicals which are sealed at the end of a plastic or metal strip. Body heat causes a stable color change in the heat sensitive chemicals.

(b) *Classification*. Class I (general controls). The device is exempt from the premarket notification procedures in subpart E of part 807 of this chapter, subject to the limitations in § 880.9.

[45 FR 69682, Oct. 21, 1980, as amended at 61 FR 1123, Jan. 16, 1996; 66 FR 38804, July 25, 2001]

## § 880.2910 Clinical electronic thermometer.

(a) *Identification*. A clinical electronic thermometer is a device used to measure the body temperature of a patient by means of a transducer coupled with an electronic signal amplification, conditioning, and display unit. The transducer may be in a detachable probe with or without a disposable cover.

(b) *Classification*. Class II (performance standards).

## § 880.2920 Clinical mercury thermometer.

(a) *Identification*. A clinical mercury thermometer is a device used to measure oral, rectal, or axillary (armpit) body temperature using the thermal expansion of mercury.

(b) *Classification*. Class II (special controls). The device is exempt from the premarket notification procedures in subpart E of part 807 of this chapter subject to § 880.9.

[45 FR 69682, Oct. 21, 1980, as amended at 63 FR 59228, Nov. 3, 1998]

## § 880.2930 Apgar timer.

(a) *Identification*. The Apgar timer is a device intended to alert a health care provider to take the Apgar score of a newborn infant.

(b) *Classification*. Class I (general controls). The device is exempt from the

premarket notification procedures in subpart E of part 807 of this chapter subject to the limitations in § 880.9. The device is also exempt from the current good manufacturing practice requirements in part 820 of this chapter, with the exception of § 820.180 of this chapter, with respect to general requirements concerning records, and § 820.198 of this chapter, with respect to complaint files.

[63 FR 59718, Nov. 5, 1998]

### Subparts D–E [Reserved]

### Subpart F—General Hospital and Personal Use Therapeutic Devices

#### § 880.5025 I.V. container.

(a) *Identification.* An I.V. container is a container made of plastic or glass used to hold a fluid mixture to be administered to a patient through an intravascular administration set.

(b) *Classification.* Class II (performance standards).

#### § 880.5045 Medical recirculating air cleaner.

(a) *Identification.* A medical recirculating air cleaner is a device used to remove particles from the air for medical purposes. The device may function by electrostatic precipitation or filtration.

(b) *Classification.* Class II (performance standards).

#### § 880.5075 Elastic bandage.

(a) *Identification.* An elastic bandage is a device consisting of either a long flat strip or a tube of elasticized material that is used to support and compress a part of a patient's body.

(b) *Classification.* Class I (general controls). The device is exempt from the premarket notification procedures in subpart E of part 807 of this chapter, subject to the limitations in § 880.9. The device also is exempt from the current good manufacturing practice requirements of the quality system regulation in part 820 of this chapter, with the exception of § 820.180, with respect to general requirements concerning records,

and § 820.198, with respect to complaint files.

[45 FR 69682, Oct. 21, 1980, as amended at 66 FR 38804, July 25, 2001]

#### § 880.5090 Liquid bandage.

(a) *Identification.* A liquid bandage is a sterile device that is a liquid, semiliquid, or powder and liquid combination used to cover an opening in the skin or as a dressing for burns. The device is also used as a topical skin protectant.

(b) *Classification.* Class I (general controls). When used only as a skin protectant, the device is exempt from the premarket notification procedures in subpart E of part 807 of this chapter subject to § 880.9.

[45 FR 69682, Oct. 21, 1980, as amended at 65 FR 2318, Jan. 14, 2000]

#### § 880.5100 AC-powered adjustable hospital bed.

(a) *Identification.* An AC-powered adjustable hospital bed is a device intended for medical purposes that consists of a bed with a built-in electric motor and remote controls that can be operated by the patient to adjust the height and surface contour of the bed. The device includes movable and latchable side rails.

(b) *Classification.* Class II (special controls). The device is exempt from the premarket notification procedures in subpart E of part 807 of this chapter subject to § 880.9.

[45 FR 69682, Oct. 21, 1980, as amended at 63 FR 59229, Nov. 3, 1998]

#### § 880.5110 Hydraulic adjustable hospital bed.

(a) *Identification.* A hydraulic adjustable hospital bed is a device intended for medical purposes that consists of a bed with a hydraulic mechanism operated by an attendant to adjust the height and surface contour of the bed. The device includes movable and latchable side rails.

(b) *Classification.* Class I (general controls). The device is exempt from the premarket notification procedures in subpart E of part 807 of this chapter, subject to the limitations in § 880.9.

[45 FR 69682, Oct. 21, 1980, as amended at 66 FR 38804, July 25, 2001]

## § 880.5120

### § 880.5120 Manual adjustable hospital bed.

(a) *Identification.* A manual adjustable hospital bed is a device intended for medical purposes that consists of a bed with a manual mechanism operated by an attendant to adjust the height and surface contour of the bed. The device includes movable and latchable side rails.

(b) *Classification.* Class I (general controls). The device is exempt from the premarket notification procedures in subpart E of part 807 of this chapter, subject to the limitations in § 880.9. The device is also exempt from the current good manufacturing practice requirements of the quality system regulation in part 820 of this chapter, with the exception of § 820.180, with respect to general requirements concerning records, and § 820.198, with respect to complaint files.

[45 FR 69682, Oct. 21, 1980, as amended at 54 FR 25050, June 12, 1989; 66 FR 38804, July 25, 2001]

### § 880.5130 Infant radiant warmer.

(a) *Identification.* The infant radiant warmer is a device consisting of an infrared heating element intended to be placed over an infant to maintain the infant's body temperature by means of radiant heat. The device may also contain a temperature monitoring sensor, a heat output control mechanism, and an alarm system (infant temperature, manual mode if present, and failure alarms) to alert operators of a temperature condition over or under the set temperature, manual mode time limits, and device component failure, respectively. The device may be placed over a pediatric hospital bed or it may be built into the bed as a complete unit.

(b) *Classification.* Class II (Special Controls):

(1) The Association for the Advancement of Medical Instrumentation (AAMI) Voluntary Standard for the Infant Radiant Warmer;

(2) A prescription statement in accordance with § 801.109 of this chapter (restricted to use by or upon the order of qualified practitioners as determined by the States); and

(3) Labeling for use only in health care facilities and only by persons with

## 21 CFR Ch. I (4-1-20 Edition)

specific training and experience in the use of the device.

[62 FR 33350, June 19, 1997]

### § 880.5140 Pediatric medical crib.

(a) *Identification.* A pediatric medical crib is a prescription device intended for medical purposes for use with a pediatric patient that consists of an open crib, fixed end rails, movable and latchable side rail components, and possibly an accompanying mattress. The contour of the crib surface may be adjustable.

(b) *Classification.* Class II (special controls). The device is exempt from the premarket notification procedures in subpart E of part 807 of this chapter subject to § 880.9. The special controls for this device are:

(1) Crib design and performance testing shall demonstrate the mechanical and structural stability of the crib under expected conditions of use, including the security of latches and other locking mechanisms when engaged;

(2) Materials used shall be appropriate for the conditions of use, allow for proper sanitation, and be free from surface defects that could result in injuries;

(3) The height of the rail and end panel as measured from the top of the rail or panel in its highest position to the top of the mattress support in its lowest position shall be at least 26 inches (66 centimeters). Any mattress used in this crib must not exceed a thickness of 6 inches;

(4) Hardware and fasteners shall be designed and constructed to eliminate mechanical hazards to the patient;

(5) The distance between components of the side rail (*i.e.*, slats, spindles, and corner posts) shall not be greater than 2 $\frac{3}{8}$  inches (6 centimeters) apart at any point;

(6) The mattress must fit tightly around all four sides of the crib base, such that entrapment or impingement of occupant is prevented;

(7) The mattress for the crib shall meet the Consumer Product Safety Commission (CPSC) Standard for the flammability of mattresses and mattress pads (FF 4-72, amended) and Standard for the flammability (open

flame) of mattress sets, 16 CFR parts 1632 and 1633, respectively; and

(8) Each device must have the following label(s) affixed:

(i) Adequate instructions for users to care for, maintain, and clean the crib; and

(ii) A warning label on at least two sides of the medical crib with the following language in text of at least 9 millimeters in height:

**WARNING:** Never leave a child unsupervised when the moveable side is open or not secured.

[81 FR 91737, Dec. 19, 2016]

#### § 880.5145 Medical bassinet.

(a) *Identification.* A medical bassinet is a prescription device that is a small bed intended for use with pediatric patients, generally from birth to approximately 5 months of age. It is intended for medical purposes for use in a nursery, labor and delivery unit, or patient room, but may also be used outside of traditional health care settings. A medical bassinet is a non-powered device that consists of two components: The plastic basket or bed component and a durable frame with wheels, which holds the basket or bed component. The basket or bed component is a box-like structure, generally made of a clear, high impact-resistant plastic material, with an open top and four stationary walls to hold the pediatric patient. The frame can include drawers, shelving, or cabinetry that provides space to hold infant care items. The wheels or casters allow the bassinet to transport the infant throughout the care setting.

(b) *Classification.* Class II (special controls). The device is exempt from the premarket notification procedures in subpart E of part 807 of this chapter subject to § 880.9. The special controls for this device are:

(1) The manufacturer must conduct performance testing to determine material compatibility with cleansing products labeled to clean the device. Testing must demonstrate that the cleaning instructions provided by the manufacturer do not cause crazing, cracking, or deterioration of the device;

(2) Manufacturers shall conduct performance testing to ensure the mechanical and structural stability of the bassinet under expected conditions of use, including transport of patients in the bassinet. Testing must demonstrate that failures such as wheel or caster breakage do not occur and that the device does not present a tipping hazard due to any mechanical failures under expected conditions of use; and

(3) Each device must have the following label(s) affixed:

(i) Adequate instructions for users to care for, maintain, and clean the bassinet; and

(ii) A warning label on at least two sides of the plastic basket or bed component with the following language in text of at least 9 millimeters in height:

**WARNING:** To avoid tipping hazards of this device, make sure that the basket or bed component sits firmly in the base and that all doors, drawers, and casters are secure.

[81 FR 91737, Dec. 19, 2016]

#### § 880.5150 Nonpowered flotation therapy mattress.

(a) *Identification.* A nonpowered flotation therapy mattress is a mattress intended for medical purposes which contains air, fluid, or other materials that have the functionally equivalent effect of supporting a patient and avoiding excess pressure on local body areas. The device is intended to treat or prevent decubitus ulcers (bed sores).

(b) *Classification.* Class I (general controls). The device is exempt from the premarket notification procedures in subpart E of part 807 of this chapter, subject to the limitations in § 880.9. The device also is exempt from the current good manufacturing practice requirements of the quality system regulation in part 820 of this chapter, with the exception of § 820.180, with respect to general requirements concerning records, and § 820.198, with respect to complaint files.

[45 FR 69682, Oct. 21, 1980, as amended at 66 FR 38804, July 25, 2001]

#### § 880.5160 Therapeutic medical binder.

(a) *Identification.* A therapeutic medical binder is a device, usually made of

## § 880.5180

cloth, that is intended for medical purposes and that can be secured by ties so that it supports the underlying part of the body or holds a dressing in place. This generic type of device includes the abdominal binder, breast binder, and perineal binder.

(b) *Classification.* Class I (general controls). The device is exempt from the premarket notification procedures in subpart E of part 807 of this chapter, subject to the limitations in § 880.9. If the device is not labeled or otherwise represented as sterile, it is also exempt from the current good manufacturing practice requirements of the quality system regulation in part 820 of this chapter, with the exception of § 820.180, with respect to general requirements concerning records, and § 820.198, with respect to complaint files.

[45 FR 69682, Oct. 21, 1980, as amended at 66 FR 38804, July 25, 2001]

## § 880.5180 Burn sheet.

(a) *Identification.* A burn sheet is a device made of a porous material that is wrapped around a burn victim to retain body heat, to absorb wound exudate, and to serve as a barrier against contaminants.

(b) *Classification.* Class I (general controls). The device is exempt from the premarket notification procedures in subpart E of part 807 of this chapter, subject to the limitations in § 880.9.

[45 FR 69682, Oct. 21, 1980, as amended at 59 FR 63011, Dec. 7, 1994; 66 FR 38804, July 25, 2001]

## § 880.5200 Intravascular catheter.

(a) *Identification.* An intravascular catheter is a device that consists of a slender tube and any necessary connecting fittings and that is inserted into the patient's vascular system for short term use (less than 30 days) to sample blood, monitor blood pressure, or administer fluids intravenously. The device may be constructed of metal, rubber, plastic, or a combination of these materials.

(b) *Classification.* Class II (performance standards).

## 21 CFR Ch. I (4–1–20 Edition)

### § 880.5210 Intravascular catheter securement device.

(a) *Identification.* An intravascular catheter securement device is a device with an adhesive backing that is placed over a needle or catheter and is used to keep the hub of the needle or the catheter flat and securely anchored to the skin.

(b) *Classification.* Class I (general controls). The device is exempt from the premarket notification procedures in subpart E of part 807 of this chapter, subject to the limitations in § 880.9.

[45 FR 69682, Oct. 21, 1980, as amended at 59 FR 63011, Dec. 7, 1994; 66 FR 38804, July 25, 2001]

### § 880.5240 Medical adhesive tape and adhesive bandage.

(a) *Identification.* A medical adhesive tape or adhesive bandage is a device intended for medical purposes that consists of a strip of fabric material or plastic, coated on one side with an adhesive, and may include a pad of surgical dressing without a disinfectant. The device is used to cover and protect wounds, to hold together the skin edges of a wound, to support an injured part of the body, or to secure objects to the skin.

(b) *Classification.* Class I (general controls). The device is exempt from the premarket notification procedures in subpart E of part 807 of this chapter, subject to the limitations in § 880.9.

[45 FR 69682, Oct. 21, 1980, as amended at 59 FR 63011, Dec. 7, 1994; 66 FR 38804, July 25, 2001]

### § 880.5270 Neonatal eye pad.

(a) *Identification.* A neonatal eye pad is an opaque device used to cover and protect the eye of an infant during therapeutic procedures, such as phototherapy.

(b) *Classification.* Class I (general controls). The device is exempt from the premarket notification procedures in subpart E of part 807 of this chapter subject to § 880.9. If the device is not labeled or otherwise represented as sterile, it is exempt from the current good manufacturing practice requirements of the quality system regulation in

## Food and Drug Administration, HHS

## § 880.5440

part 820 of this chapter, with the exception of § 820.180 of this chapter, with respect to general requirements concerning records, and § 820.198 of this chapter, with respect to complaint files.

[45 FR 69682, Oct. 21, 1980, as amended at 65 FR 2318, Jan. 14, 2000]

### § 880.5300 Medical absorbent fiber.

(a) *Identification.* A medical absorbent fiber is a device intended for medical purposes that is made from cotton or synthetic fiber in the shape of a ball or a pad and that is used for applying medication to, or absorbing small amounts of body fluids from, a patient's body surface. Absorbent fibers intended solely for cosmetic purposes are not included in this generic device category.

(b) *Classification.* Class I (general controls). The device is exempt from the premarket notification procedures in subpart E of part 807 of this chapter, subject to the limitations in § 880.9. If the device is not labeled or otherwise represented as sterile, it is also exempt from the current good manufacturing practice requirements of the quality system regulation in part 820 of this chapter, with the exception of § 820.180, with respect to general requirements concerning records, and § 820.198, with respect to complaint files.

[45 FR 69682, Oct. 21, 1980, as amended at 66 FR 38804, July 25, 2001]

### § 880.5400 Neonatal incubator.

(a) *Identification.* A neonatal incubator is a device consisting of a rigid boxlike enclosure in which an infant may be kept in a controlled environment for medical care. The device may include an AC-powered heater, a fan to circulate the warmed air, a container for water to add humidity, a control valve through which oxygen may be added, and access ports for nursing care.

(b) *Classification.* Class II (performance standards).

### § 880.5410 Neonatal transport incubator.

(a) *Identification.* A neonatal transport incubator is a device consisting of a portable rigid boxlike enclosure with

insulated walls in which an infant may be kept in a controlled environment while being transported for medical care. The device may include straps to secure the infant, a battery-operated heater, an AC-powered battery charger, a fan to circulate the warmed air, a container for water to add humidity, and provision for a portable oxygen bottle.

(b) *Classification.* Class II (performance standards).

### § 880.5420 Pressure infusor for an I.V. bag.

(a) *Identification.* A pressure infusor for an I.V. bag is a device consisting of an inflatable cuff which is placed around an I.V. bag. When the device is inflated, it increases the pressure on the I.V. bag to assist the infusion of the fluid.

(b) *Classification.* Class I (general controls). The device is exempt from the premarket notification procedures in subpart E of part 807 of this chapter subject to § 880.9.

[45 FR 69682, Oct. 21, 1980, as amended at 65 FR 2318, Jan. 14, 2000]

### § 880.5430 Nonelectrically powered fluid injector.

(a) *Identification.* A nonelectrically powered fluid injector is a nonelectrically powered device used by a health care provider to give a hypodermic injection by means of a narrow, high velocity jet of fluid which can penetrate the surface of the skin and deliver the fluid to the body. It may be used for mass inoculations.

(b) *Classification.* Class II (performance standards).

### § 880.5440 Intravascular administration set.

(a) *Identification.* An intravascular administration set is a device used to administer fluids from a container to a patient's vascular system through a needle or catheter inserted into a vein. The device may include the needle or catheter, tubing, a flow regulator, a drip chamber, an infusion line filter, an I.V. set stopcock, fluid delivery tubing, connectors between parts of the set, a side tube with a cap to serve as an injection site, and a hollow spike to penetrate and connect the tubing to an

**§ 880.5445**

**21 CFR Ch. I (4–1–20 Edition)**

I.V. bag or other infusion fluid container.

(b) *Classification.* Class II (special controls). The special control for pharmacy compounding systems within this classification is the FDA guidance document entitled “Class II Special Controls Guidance Document: Pharmacy Compounding Systems; Final Guidance for Industry and FDA Reviewers.” Pharmacy compounding systems classified within the intravascular administration set are exempt from the pre-market notification procedures in subpart E of this part and subject to the limitations in § 880.9.

[45 FR 69682, Oct. 21, 1980, as amended at 66 FR 15798, Mar. 21, 2001]

**§ 880.5445 Intravascular administration set, automated air removal system.**

(a) *Identification.* An intravascular administration set, automated air removal system, is a prescription device used to detect and automatically remove air from an intravascular administration set with minimal to no interruption in the flow of the intravascular fluid. The device may include an air identification mechanism, software, an air removal mechanism, tubing, apparatus to collect removed air, and safety control mechanisms to address hazardous situations.

(b) *Classification.* Class II (special controls). The special controls for this device are:

(1) Provide an argument demonstrating that all reasonably foreseeable hazards have been adequately addressed with respect to the persons for whose use the device is represented or intended and the conditions of use for the device, which includes the following:

(i) Description of the device indications for use, design, and technology, use environments, and users in sufficient detail to determine that the device complies with all special controls.

(ii) Demonstrate that controls are implemented to address device system hazards and their causes.

(iii) Include a justification supporting the acceptability criteria for each hazard control.

(iv) A traceability analysis demonstrating that all credible hazards

have at least one corresponding control and that all controls have been verified and validated in the final device design.

(2) Appropriate software verification, validation, and hazard analysis must be performed.

(3) The device parts that directly or indirectly contact the patient must be demonstrated to be biocompatible.

(4) Performance data must demonstrate the sterility of fluid path contacting components and the shelf life of these components.

(5) The device must be designed and tested for electrical safety and electromagnetic compatibility (EMC).

(6) Nonclinical performance testing data must demonstrate that the device performs as intended under anticipated conditions of use. The following performance characteristics must be tested:

(i) Device system and component reliability testing must be conducted.

(ii) Fluid ingress protection testing must be conducted.

(iii) Testing of safety controls must be performed to demonstrate adequate mitigation of hazardous situations, including sensor failure, flow control failure, improper device position, device malfunction, infusion delivery error, and release of air to the patient.

(7) A human factors validation study must demonstrate that use hazards are adequately addressed.

(8) The labeling must include the following:

(i) The device’s air identification and removal response time.

(ii) The device’s minimum air volume identification sensitivity.

(iii) The minimum and maximum flow rates at which the device is capable of reliably detecting and removing air.

(iv) Quantification of any fluid loss during device air removal operations as a function of flow rate.

[79 FR 28406, May 16, 2014]

**§ 880.5450 Patient care reverse isolation chamber.**

(a) *Identification.* A patient care reverse isolation chamber is a device consisting of a roomlike enclosure designed to prevent the entry of harmful airborne material. This device protects



a patient who is undergoing treatment for burns or is lacking a normal immunosuppressive defense due to therapy or congenital abnormality. The device includes fans and air filters which maintain an atmosphere of clean air at a pressure greater than the air pressure outside the enclosure.

(b) *Classification.* Class II (performance standards).

#### § 880.5475 Jet lavage.

(a) *Identification.* A jet lavage is a device used to clean a wound by a pulsatile jet of sterile fluid. The device consists of the pulsing head, tubing to connect to a container of sterile fluid, and a means of propelling the fluid through the tubing, such as an electric roller pump.

(b) *Classification.* Class II (special controls). The device is exempt from the premarket notification procedures in subpart E of part 807 of this chapter subject to § 880.9.

[45 FR 69682, Oct. 21, 1980, as amended at 63 FR 59229, Nov. 3, 1998]

#### § 880.5500 AC-powered patient lift.

(a) *Identification.* An AC-powered lift is an electrically powered device either fixed or mobile, used to lift and transport patients in the horizontal or other required position from one place to another, as from a bed to a bath. The device includes straps and slings to support the patient.

(b) *Classification.* Class II (special controls). The device is exempt from the premarket notification procedures in subpart E of part 807 of this chapter subject to § 880.9.

[45 FR 69682, Oct. 21, 1980, as amended at 63 FR 59229, Nov. 3, 1998]

#### § 880.5510 Non-AC-powered patient lift.

(a) *Identification.* A non-AC-powered patient lift is a hydraulic, battery, or mechanically powered device, either fixed or mobile, used to lift and transport a patient in the horizontal or other required position from one place to another, as from a bed to a bath. The device includes straps and a sling to support the patient.

(b) *Classification.* Class I (general controls). The device is exempt from the

premarket notification procedures in subpart E of part 807 of this chapter, subject to the limitations in § 880.9.

[45 FR 69682, Oct. 21, 1980, as amended at 54 FR 25050, June 12, 1989; 66 FR 38804, July 25, 2001]

#### § 880.5550 Alternating pressure air flotation mattress.

(a) *Identification.* An alternating pressure air flotation mattress is a device intended for medical purposes that consists of a mattress with multiple air cells that can be filled and emptied in an alternating pattern by an associated control unit to provide regular, frequent, and automatic changes in the distribution of body pressure. The device is used to prevent and treat decubitus ulcers (bed sores).

(b) *Classification.* Class II (special controls). The device is exempt from the premarket notification procedures in subpart E of part 807 of this chapter subject to § 880.9.

[45 FR 69682, Oct. 21, 1980, as amended at 63 FR 59229, Nov. 3, 1998]

#### § 880.5560 Temperature regulated water mattress.

(a) *Identification.* A temperature regulated water mattress is a device intended for medical purposes that consists of a mattress of suitable size, filled with water which can be heated or in some cases cooled. The device includes electrical heating and water circulating components, and an optional cooling component. The temperature control may be manual or automatic.

(b) *Classification.* Class I (general controls). The device is exempt from the premarket notification procedures in subpart E of part 807 of this chapter, subject to the limitations in § 880.9.

[45 FR 69682, Oct. 21, 1980, as amended at 61 FR 1123, Jan. 16, 1996; 66 FR 38804, July 25, 2001]

#### § 880.5570 Hypodermic single lumen needle.

(a) *Identification.* A hypodermic single lumen needle is a device intended to inject fluids into, or withdraw fluids from, parts of the body below the surface of the skin. The device consists of a metal tube that is sharpened at one

## § 880.5580

end and at the other end joined to a female connector (hub) designed to mate with a male connector (nozzle) of a piston syringe or an intravascular administration set.

(b) *Classification.* Class II (performance standards).

## § 880.5580 Acupuncture needle.

(a) *Identification.* An acupuncture needle is a device intended to pierce the skin in the practice of acupuncture. The device consists of a solid, stainless steel needle. The device may have a handle attached to the needle to facilitate the delivery of acupuncture treatment.

(b) *Classification.* Class II (special controls). The device, when it is an acupuncture point locator or a single use acupuncture needle, is exempt from the premarket notification procedures in subpart E of part 807 of this chapter subject to the limitations in § 880.9. Acupuncture needles must comply with the following special controls:

(1) Labeling for single use only and conformance to the requirements for prescription devices set out in 21 CFR 801.109,

(2) Device material biocompatibility, and

(3) Device sterility.

[61 FR 64617, Dec. 6, 1996, as amended at 84 FR 71815, Dec. 30, 2019]

## § 880.5630 Nipple shield.

(a) *Identification.* A nipple shield is a device consisting of a cover used to protect the nipple of a nursing woman. This generic device does not include nursing pads intended solely to protect the clothing of a nursing woman from milk.

(b) *Classification.* Class I (general controls). The device is exempt from the premarket notification procedures in subpart E of part 807 of this chapter, subject to the limitations in § 880.9.

[45 FR 69682, Oct. 21, 1980, as amended at 59 FR 63011, Dec. 7, 1994; 66 FR 33804, July 25, 2001]

## § 880.5640 Lamb feeding nipple.

(a) *Identification.* A lamb feeding nipple is a device intended for use as a feeding nipple for infants with oral or facial abnormalities.

## 21 CFR Ch. I (4–1–20 Edition)

(b) *Classification.* Class I (general controls). The device is exempt from the premarket notification procedures in subpart E of part 807 of this chapter, subject to the limitations in § 880.9. If the device is not labeled or otherwise represented as sterile, it is also exempt from the current good manufacturing practice requirements of the quality system regulation in part 820 of this chapter, with the exception of § 820.180, with respect to general requirements concerning records, and § 820.198, with respect to complaint files.

[45 FR 69682, Oct. 21, 1980, as amended at 66 FR 38804, July 25, 2001]

## § 880.5680 Pediatric position holder.

(a) *Identification.* A pediatric position holder is a device used to hold an infant or a child in a desired position for therapeutic or diagnostic purposes, e.g., in a crib under a radiant warmer, or to restrain a child while an intravascular injection is administered.

(b) *Classification.* Class I (general controls). Except when the device is an infant positioner for prescription use in highly monitored settings or an infant sleep position holder, it is exempt from the premarket notification procedures in subpart E of part 807 of this chapter subject to the limitations in § 880.9. The device is exempt from the good manufacturing practice regulation in part 820 of this chapter, with the exception of § 820.180, with respect to general requirements concerning records, and § 820.198, with respect to complaint files.

[45 FR 69682, Oct. 21, 1980, as amended at 66 FR 46952, Sept. 10, 2001; 84 FR 71815, Dec. 30, 2019]

## § 880.5700 Neonatal phototherapy unit.

(a) *Identification.* A neonatal phototherapy unit is a device used to treat or prevent hyperbilirubinemia (elevated serum bilirubin level). The device consists of one or more lamps that emit a specific spectral band of light, under which an infant is placed for therapy. This generic type of device may include supports for the patient and equipment and component parts.

(b) *Classification.* Class II (performance standards).

**§ 880.5725 Infusion pump.**

(a) *Identification.* An infusion pump is a device used in a health care facility to pump fluids into a patient in a controlled manner. The device may use a piston pump, a roller pump, or a peristaltic pump and may be powered electrically or mechanically. The device may also operate using a constant force to propel the fluid through a narrow tube which determines the flow rate. The device may include means to detect a fault condition, such as air in, or blockage of, the infusion line and to activate an alarm.

(b) *Classification.* Class II (performance standards).

**§ 880.5740 Suction snakebite kit.**

(a) *Identification.* A suction snakebite kit is a device consisting of a knife, suction device, and tourniquet used for first-aid treatment of snakebites by removing venom from the wound.

(b) *Classification.* Class I (general controls). The device is exempt from the premarket notification procedures in subpart E of part 807 of this chapter, subject to the limitations in § 880.9.

[45 FR 69682, Oct. 21, 1980, as amended at 59 FR 63011, Dec. 7, 1994; 66 FR 38805, July 25, 2001]

**§ 880.5760 Chemical cold pack snakebite kit.**

(a) *Identification.* A chemical cold pack snakebite kit is a device consisting of a chemical cold pack and tourniquet used for first-aid treatment of snakebites.

(b) *Classification.* Class III (premarket approval).

(c) *Date PMA or notice of completion of a PDP is required.* A PMA or a notice of completion of a PDP is required to be filed with the Food and Drug Administration on or before December 26, 1996 for any chemical cold pack snakebite kit that was in commercial distribution before May 28, 1976, or that has, on or before December 26, 1996 been found to be substantially equivalent to a chemical cold pack snakebite kit that was in commercial distribution before May 28, 1976. Any other chemical cold pack snakebite kit shall have an approved PMA or a declared completed

PDP in effect before being placed in commercial distribution.

[45 FR 69682, Oct. 21, 1980, as amended at 52 FR 17739, May 11, 1987; 61 FR 50708, Sept. 27, 1996]

**§ 880.5780 Medical support stocking.**

(a) *Medical support stocking to prevent the pooling of blood in the legs—(1) Identification.* A medical support stocking to prevent the pooling of blood in the legs is a device that is constructed of elastic material and designed to apply controlled pressure to the leg and that is intended for use in the prevention of pooling of blood in the leg.

(2) *Classification.* Class II (special controls). The device is exempt from the premarket notification procedures in subpart E of part 807 of this chapter subject to the limitations in § 880.9.

(b) *Medical support stocking for general medical purposes—(1) Identification.* A medical support stocking for general medical purposes is a device that is constructed of elastic material and designed to apply controlled pressure to the leg and that is intended for medical purposes other than the prevention of pooling of blood in the leg.

(2) *Classification.* Class I. The device is exempt from the premarket notification procedures in subpart E of part 807 of this chapter, subject to the limitations in § 880.9. The device is also exempt from the current good manufacturing practice requirements of the quality system regulation in part 820 of this chapter, with the exception of § 820.180, with respect to general requirements concerning records, and § 820.198, with respect to complaint files.

[45 FR 69682, Oct. 21, 1980, as amended at 59 FR 63011, Dec. 7, 1994; 66 FR 38805, July 25, 2001; 84 FR 71815, Dec. 30, 2019]

**§ 880.5820 Therapeutic scrotal support.**

(a) *Identification.* A therapeutic scrotal support is a device intended for medical purposes that consist of a pouch attached to an elastic waistband and that is used to support the scrotum (the sac that contains the testicles).

(b) *Classification.* Class I (general controls). The device is exempt from the premarket notification procedures in subpart E of part 807 of this chapter, subject to the limitations in § 880.9. The

**§ 880.5860**

device also is exempt from the current good manufacturing practice requirements of the quality system regulation in part 820 of this chapter, with the exception of § 820.180, with respect to general requirements concerning records, and § 820.198, with respect to complaint files.

[45 FR 69682, Oct. 21, 1980, as amended at 66 FR 38805, July 25, 2001]

**§ 880.5860 Piston syringe.**

(a) *Identification.* A piston syringe is a device intended for medical purposes that consists of a calibrated hollow barrel and a movable plunger. At one end of the barrel there is a male connector (nozzle) for fitting the female connector (hub) of a hypodermic single lumen needle. The device is used to inject fluids into, or withdraw fluids from, the body.

(b) *Classification.* Class II (performance standards).

**§ 880.5950 Umbilical occlusion device.**

(a) *Identification.* An umbilical occlusion device is a clip, tie, tape, or other article used to close the blood vessels in the umbilical cord of a newborn infant.

(b) *Classification.* Class I (general controls). The device is exempt from the premarket notification procedures in subpart E of part 807 of this chapter, subject to the limitations in § 880.9.

[45 FR 69682, Oct. 21, 1980, as amended at 59 FR 63011, Dec. 7, 1994; 66 FR 38805, July 25, 2001]

**§ 880.5960 Lice removal kit.**

(a) *Identification.* The lice removal kit is a comb or comb-like device intended to remove and/or kill lice and nits from head and body hair. It may or may not be battery operated.

(b) *Classification.* Class I (general controls). The device is exempt from the premarket notification procedures in subpart E of part 807 of this chapter subject to the limitations in § 880.9.

[63 FR 59718, Nov. 5, 1998]

**§ 880.5965 Subcutaneous, implanted, intravascular infusion port and catheter.**

(a) *Identification.* A subcutaneous, implanted, intravascular infusion port

**21 CFR Ch. I (4–1–20 Edition)**

and catheter is a device that consists of a subcutaneous, implanted reservoir that connects to a long-term intravascular catheter. The device allows for repeated access to the vascular system for the infusion of fluids and medications and the sampling of blood. The device consists of a portal body with a resealable septum and outlet made of metal, plastic, or combination of these materials and a long-term intravascular catheter is either preattached to the port or attached to the port at the time of device placement. The device is available in various profiles and sizes and can be of a single or multiple lumen design.

(b) *Classification.* Class II (special controls) Guidance Document: “Guidance on 510(k) Submissions for Implanted Infusion Ports,” FDA October 1990.

[65 FR 37043, June 13, 2000]

**§ 880.5970 Percutaneous, implanted, long-term intravascular catheter.**

(a) *Identification.* A percutaneous, implanted, long-term intravascular catheter is a device that consists of a slender tube and any necessary connecting fittings, such as luer hubs, and accessories that facilitate the placement of the device. The device allows for repeated access to the vascular system for long-term use of 30 days or more, and it is intended for administration of fluids, medications, and nutrients; the sampling of blood; and monitoring blood pressure and temperature. The device may be constructed of metal, rubber, plastic, composite materials, or any combination of these materials and may be of single or multiple lumen design.

(b) *Classification.* Class II (special controls) Guidance Document: “Guidance on Premarket Notification [510(k)] Submission for Short-Term and Long-Term Intravascular Catheters.”

[65 FR 37043, June 13, 2000]

### Subpart G—General Hospital and Personal Use Miscellaneous Devices

#### § 880.6025 Absorbent tipped applicator.

(a) *Identification.* An absorbent tipped applicator is a device intended for medical purposes that consists of an absorbent swab on a wooden, paper, or plastic stick. The device is used to apply medications to, or to take specimens from, a patient.

(b) *Classification.* Class I (general controls). The device is exempt from the premarket notification procedures in subpart E of part 807 of this chapter, subject to the limitations in § 880.9. If the device is not labeled or otherwise represented as sterile, it is also exempt from the current good manufacturing practice requirements of the quality system regulation in part 820 of this chapter, with the exception of § 820.180, with respect to general requirements concerning records, and § 820.198, with respect to complaint files.

[45 FR 69682, Oct. 21, 1980, as amended at 66 FR 38805, July 25, 2001]

#### § 880.6050 Ice bag.

(a) *Identification.* An ice bag is a device intended for medical purposes that is in the form of a container intended to be filled with ice that is used to apply dry cold therapy to an area of the body. The device may include a holder that keeps the bag in place against an external area of the patient.

(b) *Classification.* Class I (general controls). The device is exempt from the premarket notification procedures in subpart E of part 807 of this chapter, subject to the limitations in § 880.9. If the device is not labeled or otherwise represented as sterile, it is also exempt from the current good manufacturing practice requirements of the quality system regulation in part 820 of this chapter, with the exception of § 820.180, with respect to general requirements concerning records, and § 820.198, with respect to complaint files.

[45 FR 69682, Oct. 21, 1980, as amended at 66 FR 38805, July 25, 2001]

#### § 880.6060 Medical disposable bedding.

(a) *Identification.* Medical disposable bedding is a device intended for medical purposes to be used by one patient for a period of time and then discarded. This generic type of device may include disposable bedsheets, bedpads, pillows and pillowcases, blankets, emergency rescue blankets, or waterproof sheets.

(b) *Classification.* Class I (general controls). The device is exempt from the premarket notification procedures in subpart E of part 807 of this chapter, subject to the limitations in § 880.9. If the device is not labeled or otherwise represented as sterile, it is also exempt from the current good manufacturing practice requirements of the quality system regulation in part 820 of this chapter, with the exception of § 820.180, with respect to general requirements concerning records, and § 820.198, with respect to complaint files.

[45 FR 69682, Oct. 21, 1980, as amended at 59 FR 63011, Dec. 7, 1994; 66 FR 38805, July 25, 2001]

#### § 880.6070 Bed board.

(a) *Identification.* A bed board is a device intended for medical purposes that consists of a stiff board used to increase the firmness of a bed.

(b) *Classification.* Class I (general controls). The device is exempt from the premarket notification procedures in subpart E of part 807 of this chapter, subject to the limitations in § 880.9. The device is also exempt from the current good manufacturing practice requirements of the quality system regulation in part 820 of this chapter, with the exception of § 820.180, with respect to general requirements concerning records, and § 820.198, with respect to complaint files.

[45 FR 69682, Oct. 21, 1980, as amended at 66 FR 38805, July 25, 2001]

#### § 880.6080 Cardiopulmonary resuscitation board.

(a) *Identification.* A cardiopulmonary resuscitation board is a device consisting of a rigid board which is placed under a patient to act as a support during cardiopulmonary resuscitation.

(b) *Classification.* Class I (general controls). The device is exempt from the

## § 880.6085

premarket notification procedures in subpart E of part 807 of this chapter, subject to the limitations in § 880.9. The device is also exempt from the current good manufacturing practice requirements of the quality system regulation in part 820 of this chapter, with the exception of § 820.180, with respect to general requirements concerning records, and § 820.198, with respect to complaint files.

[45 FR 69682, Oct. 21, 1980, as amended at 66 FR 38805, July 25, 2001]

### § 880.6085 Hot/cold water bottle.

(a) *Identification.* A hot/cold water bottle is a device intended for medical purposes that is in the form of a container intended to be filled with hot or cold water to apply heat or cold to an area of the body.

(b) *Classification.* Class I (general controls). The device is exempt from the premarket notification procedures in subpart E of part 807 of this chapter, subject to the limitations in § 880.9. The device is also exempt from the current good manufacturing practice requirements of the quality system regulation in part 820 of this chapter, with the exception of § 820.180, with respect to general requirements concerning records, and § 820.198, with respect to complaint files.

[45 FR 69682, Oct. 21, 1980, as amended at 66 FR 38805, July 25, 2001]

### § 880.6100 Ethylene oxide gas aerator cabinet.

(a) *Identification.* An ethylene oxide gas aerator cabinet is a device that is intended for use by a health care provider and consists of a cabinet with a ventilation system designed to circulate and exchange the air in the cabinet to shorten the time required to remove residual ethylene oxide (ETO) from wrapped medical devices that have undergone ETO sterilization. The device may include a heater to warm the circulating air.

(b) *Classification.* Class II (performance standards).

### § 880.6140 Medical chair and table.

(a) *Identification.* A medical chair or table is a device intended for medical purposes that consists of a chair or

## 21 CFR Ch. I (4–1–20 Edition)

table without wheels and not electrically powered which, by reason of special shape or attachments, such as food trays or headrests, or special features such as a built-in raising and lowering mechanism or removable arms, is intended for use of blood donors, geriatric patients, or patients undergoing treatment or examination.

(b) *Classification.* Class I (general controls). The device is exempt from the premarket notification procedures in subpart E of part 807 of this chapter, subject to the limitations in § 880.9. The device is also exempt from the current good manufacturing practice requirements of the quality system regulation in part 820 of this chapter, with the exception of § 820.180, with respect to general requirements concerning records, and § 820.198, with respect to complaint files.

[45 FR 69682, Oct. 21, 1980, as amended at 66 FR 38805, July 25, 2001]

### § 880.6150 Ultrasonic cleaner for medical instruments.

(a) *Identification.* An ultrasonic cleaner for medical instruments is a device intended for cleaning medical instruments by the emission of high frequency soundwaves.

(b) *Classification.* Class I. The device, including any solutions intended for use with the device for cleaning and sanitizing the instruments, is exempt from the premarket notification procedures in subpart E of part 807 of this chapter, subject to the limitations in § 880.9.

[45 FR 69682, Oct. 21, 1980, as amended at 54 FR 25050, June 12, 1989; 59 FR 63011, Dec. 7, 1994; 66 FR 38805, July 25, 2001]

### § 880.6175 [Reserved]

### § 880.6185 Cast cover.

(a) *Identification.* A cast cover is a device intended for medical purposes that is made of waterproof material and placed over a cast to protect it from getting wet during a shower or a bath.

(b) *Classification.* Class I (general controls). The device is exempt from the premarket notification procedures in subpart E of part 807 of this chapter, subject to the limitations in § 880.9. If the device is not labeled or otherwise represented as sterile, it is also exempt

from the current good manufacturing practice requirements of the quality system regulation in part 820 of this chapter, with the exception of § 820.180, with respect to general requirements concerning records, and § 820.198, with respect to complaint files.

[45 FR 69682, Oct. 21, 1980, as amended at 66 FR 38806, July 25, 2001]

**§ 880.6190 Mattress cover for medical purposes.**

(a) *Identification.* A mattress cover for medical purposes is a device intended for medical purposes that is used to protect a mattress. It may be electrically conductive or contain a germicide.

(b) *Classification.* Class I (general controls). The device is exempt from the premarket notification procedures in subpart E of part 807 of this chapter, subject to the limitations in § 880.9. If the device is not labeled or otherwise represented as sterile, it is also exempt from the current good manufacturing practice requirements of the quality system regulation in part 820 of this chapter, with the exception of § 820.180, with respect to general requirements concerning records, and § 820.198, with respect to complaint files.

[45 FR 69682, Oct. 21, 1980, as amended at 59 FR 63011, Dec. 7, 1994; 66 FR 38806, July 25, 2001]

**§ 880.6200 Ring cutter.**

(a) *Identification.* A ring cutter is a device intended for medical purposes that is used to cut a ring on a patient's finger so that the ring can be removed. The device incorporates a guard to prevent injury to the patient's finger.

(b) *Classification.* Class I (general controls). The device is exempt from the premarket notification procedures in subpart E of part 807 of this chapter, subject to the limitations in § 880.9. The device also is exempt from the current good manufacturing practice requirements of the quality system regulation in part 820 of this chapter, with the exception of § 820.180, with respect to general requirements concerning records, and § 820.198, with respect to complaint files.

[45 FR 69682, Oct. 21, 1980, as amended at 66 FR 38806, July 25, 2001]

**§ 880.6210 Sharps needle destruction device.**

(a) *Identification.* A sharps needle destruction device is a prescription device that is intended to destroy needles or sharps used for medical purposes by incineration or mechanical means.

(b) *Classification.* Class II (special controls). The special controls for this device are:

(1) Performance testing must demonstrate the following during operation of the device:

(i) The device safely contains or ventilates aerosols or fumes from device operation.

(ii) Excessive heat or sparks are not generated that may injure users or patients.

(iii) Simulated use testing must demonstrate sharps and/or needles are completely destroyed using a range of types and sizes of sharps sufficient to represent actual use.

(iv) Simulated use testing must demonstrate that the device is physically stable on the surface for which it is intended to be mounted to ensure the risk of harm to the patient/user as a result of the device falling is minimized.

(2) Validation of cleaning and disinfection instructions must demonstrate that the device can be safely and effectively reprocessed after use per the recommended cleaning and disinfection protocol in the instructions for use.

(3) Analysis and/or testing must validate electromagnetic compatibility and electrical safety, including the safety of any battery used in the device, under conditions which are consistent with the intended environment of device use.

(4) Software verification, validation, and hazard analysis must be performed.

(5) Labeling must include:

(i) A clear description of the device and its technological features;

(ii) How the device is to be used, including validated cleaning and disinfection instructions;

(iii) Relevant precautions and warnings based on performance and in-use testing to ensure proper use of the device; and

**§ 880.6230**

(iv) Instructions to install device in adequately ventilated area and stable area.

[83 FR 19628, May 4, 2018]

**§ 880.6230 Tongue depressor.**

(a) *Identification.* A tongue depressor is a device intended to displace the tongue to facilitate examination of the surrounding organs and tissues.

(b) *Classification.* Class I (general controls). The device is exempt from the premarket notification procedures in subpart E of part 807 of this chapter, subject to the limitations in §880.9. If the device is not labeled or otherwise represented as sterile, it is also exempt from the current good manufacturing practice requirements of the quality system regulation in part 820 of this chapter, with the exception of §820.180, with respect to general requirements concerning records, and §820.198, with respect to complaint files.

[45 FR 69682, Oct. 21, 1980, as amended at 66 FR 38806, July 25, 2001]

**§ 880.6250 Non-powdered patient examination glove.**

(a) *Identification.* A non-powdered patient examination glove is a disposable device intended for medical purposes that is worn on the examiner's hand or finger to prevent contamination between patient and examiner. A non-powdered patient examination glove does not incorporate powder for purposes other than manufacturing. The final finished glove includes only residual powder from manufacturing.

(b) *Classification.* Class I (general controls). The device, when it is a finger cot, is exempt from the premarket notification procedures in subpart E of part 807 of this chapter subject to the limitations in §880.9.

[45 FR 69682, Oct. 21, 1980, as amended at 54 FR 1604, Jan. 13, 1989; 66 FR 46952, Sept. 10, 2001; 81 FR 91730, Dec. 19, 2016; 84 FR 71815, Dec. 30, 2019]

**§ 880.6260 Filtering facepiece respirator for use by the general public in public health medical emergencies.**

(a) *Identification.* A filtering facepiece respirator for use by the general public in public health medical emergencies is

**21 CFR Ch. I (4–1–20 Edition)**

a device that is a disposable half-face-piece non-powered air-purifying particulate respirator intended for use to cover the nose and mouth of the wearer to help reduce wearer exposure to pathogenic biological airborne particulates during a public health medical emergency. The device is made of polymeric materials and is intended to fit closely to the face and to function by filtering particulate material.

(b) *Classification.* Class II (special controls). The special controls are:

(1) Certification by the National Institute for Occupational Safety and Health (NIOSH) as a non-powered air-purifying particulate respirator with a minimum filtration efficiency classification of N95, in accordance with 42 CFR part 84.

(2) The FDA guidance document entitled: "Guidance for Industry and Food and Drug Administration Staff; Class II Special Controls Guidance Document: Filtering Facepiece Respirator for use by the General Public in Public Health Medical Emergencies." See §880.1(e) for information on obtaining a copy of this guidance document.

[72 FR 36362, July 3, 2007]

**§ 880.6265 Examination gown.**

(a) *Identification.* An examination gown is a device intended for medical purposes that is made of cloth, paper, or other material that is draped over or worn by a patient as a body covering during a medical examination.

(b) *Classification.* Class I (general controls). The device is exempt from the premarket notification procedures in subpart E of part 807 of this chapter, subject to the limitations in §880.9. If the device is not labeled or otherwise represented as sterile, it is also exempt from the current good manufacturing practice requirements of the quality system regulation in part 820 of this chapter, with the exception of §820.180, with respect to general requirements concerning records, and §820.198, with respect to complaint files.

[45 FR 69682, Oct. 21, 1980, as amended at 66 FR 38806, July 25, 2001]

**§ 880.6280 Medical insole.**

(a) *Identification.* A medical insole is a device intended for medical purposes



that is placed inside a shoe to relieve the symptoms of athlete's foot infection by absorbing moisture.

(b) *Classification.* Class I (general controls). The device is exempt from the premarket notification procedures in subpart E of part 807 of this chapter, subject to the limitations in § 880.9.

[45 FR 69682, Oct. 21, 1980, as amended at 54 FR 25050, June 12, 1989; 66 FR 38806, July 25, 2001]

**§ 880.6300 Implantable radiofrequency transponder system for patient identification and health information.**

(a) *Identification.* An implantable radiofrequency transponder system for patient identification and health information is a device intended to enable access to secure patient identification and corresponding health information. This system may include a passive implanted transponder, inserter, and scanner. The implanted transponder is used only to store a unique electronic identification code that is read by the scanner. The identification code is used to access patient identity and corresponding health information stored in a database.

(b) *Classification.* Class II (special controls). The special control is FDA's guidance document entitled "Class II Special Controls Guidance Document: Implantable Radiofrequency Transponder System for Patient Identification and Health Information." See § 880.1(e) for the availability of this guidance document. This device is exempt from the premarket notification procedures in subpart E of part 807 of this chapter subject to the limitations in § 880.9.

[69 FR 71704, Dec. 10, 2004]

**§ 880.6305 Ingestible event marker.**

(a) *Identification.* An ingestible event marker is a prescription device used to record time-stamped, patient-logged events. The ingestible component links wirelessly through intrabody communication to an external recorder which records the date and time of ingestion as well as the unique serial number of the ingestible device.

(b) *Classification.* Class II (special controls). The special controls for this device are:

(1) The device must be demonstrated to be biocompatible and non-toxic;

(2) Nonclinical, animal, and clinical testing must provide a reasonable assurance of safety and effectiveness, including device performance, durability, compatibility, usability (human factors testing), event recording, and proper excretion of the device;

(3) Appropriate analysis and nonclinical testing must validate electromagnetic compatibility performance, wireless performance, and electrical safety; and

(4) Labeling must include a detailed summary of the nonclinical and clinical testing pertinent to use of the device and the maximum number of daily device ingestions.

[78 FR 28734, May 16, 2013]

**§ 880.6310 Medical device data system.**

(a) *Identification.* (1) A medical device data system (MDDS) is a device that is intended to provide one or more of the following uses, without controlling or altering the functions or parameters of any connected medical devices:

(i) The electronic transfer of medical device data;

(ii) The electronic storage of medical device data;

(iii) The electronic conversion of medical device data from one format to another format in accordance with a preset specification; or

(iv) The electronic display of medical device data.

(2) An MDDS may include software, electronic or electrical hardware such as a physical communications medium (including wireless hardware), modems, interfaces, and a communications protocol. This identification does not include devices intended to be used in connection with active patient monitoring.

(b) *Classification.* Class I (general controls). The device is exempt from the premarket notification procedures in subpart E of part 807 of this chapter, subject to the limitations in § 880.9.

[76 FR 8649, Feb. 15, 2011]

**§ 880.6315 Remote Medication Management System.**

(a) *Identification.* A remote medication management system is a device

## § 880.6320

composed of clinical and communications software, a medication delivery unit, and medication packaging. The system is intended to store the patient's prescribed medications in a delivery unit, to permit a health care professional to remotely schedule the patient's prescribed medications, to notify the patient when the prescribed medications are due to be taken, to release the prescribed medications to a tray of the delivery unit accessible to the patient on the patient's command, and to record a history of the event for the health care professional. The system is intended for use as an aid to health care professionals in managing therapeutic regimens for patients in the home or clinic.

(b) *Classification*. Class II (special controls). The special control is: The FDA guidance document entitled "Guidance for Industry and Food and Drug Administration Staff; Class II Special Controls Guidance Document: Remote Medication Management System." See § 880.1(e) for availability of this guidance document.

[72 FR 59177, Oct. 19, 2007]

## § 880.6320 AC-powered medical examination light.

(a) *Identification*. An AC-powered medical examination light is an AC-powered device intended for medical purposes that is used to illuminate body surfaces and cavities during a medical examination.

(b) *Classification*. Class I (general controls). The device is exempt from the premarket notification procedures in subpart E of part 807 of this chapter, subject to the limitations in § 880.9.

[45 FR 69682, Oct. 21, 1980, as amended at 61 FR 1123, Jan. 16, 1996; 66 FR 38806, July 25, 2001]

## § 880.6350 Battery-powered medical examination light.

(a) *Identification*. A battery-powered medical examination light is a battery-powered device intended for medical purposes that is used to illuminate body surfaces and cavities during a medical examination.

(b) *Classification*. Class I (general controls). The device is exempt from the premarket notification procedures in subpart E of part 807 of this chapter,

## 21 CFR Ch. I (4–1–20 Edition)

subject to the limitations in § 880.9. The device also is exempt from the current good manufacturing practice requirements of the quality system regulation in part 820 of this chapter, with the exception of § 820.180, with respect to general requirements concerning records, and § 820.198, with respect to complaint files.

[45 FR 69682, Oct. 21, 1980, as amended at 66 FR 38806, July 25, 2001]

## § 880.6375 Patient lubricant.

(a) *Identification*. A patient lubricant is a device intended for medical purposes that is used to lubricate a body orifice to facilitate entry of a diagnostic or therapeutic device.

(b) *Classification*. Class I (general controls). Except when the device is a vaginal patient lubricant or an oral lubricant, it is exempt from the premarket notification procedures in subpart E of part 807 of this chapter subject to the limitations in § 880.9.

[45 FR 69682, Oct. 21, 1980, as amended at 66 FR 46952, Sept. 10, 2001; 84 FR 71815, Dec. 30, 2019]

## § 880.6430 Liquid medication dispenser.

(a) *Identification*. A Liquid medication dispenser is a device intended for medical purposes that is used to issue a measured amount of liquid medication.

(b) *Classification*. Class I (general controls). The device is exempt from the premarket notification procedures in subpart E of part 807 of this chapter, subject to the limitations in § 880.9. The device is also exempt from the current good manufacturing practice requirements of the quality system regulation in part 820 of this chapter, with the exception of § 820.180, with respect to general requirements concerning records, and § 820.198, with respect to complaint files.

[45 FR 69682, Oct. 21, 1980, as amended at 66 FR 38806, July 25, 2001]

## § 880.6450 Skin pressure protectors.

(a) *Identification*. A skin pressure protector is a device intended for medical purposes that is used to reduce pressure on the skin over a bony prominence to reduce the likelihood of the

patient's developing decubitus ulcers (bedsores).

(b) *Classification.* Class I (general controls). The device is exempt from the premarket notification procedures in subpart E of part 807 of this chapter, subject to the limitations in § 880.9. The device is also exempt from the current good manufacturing practice requirements of the quality system regulation in part 820 of this chapter, with the exception of § 820.180, with respect to general requirements concerning records, and § 820.198, with respect to complaint files.

[45 FR 69682, Oct. 21, 1980, as amended at 66 FR 38806, July 25, 2001]

**§ 880.6500 Medical ultraviolet air purifier.**

(a) *Identification.* A medical ultraviolet air purifier is a device intended for medical purposes that is used to destroy bacteria in the air by exposure to ultraviolet radiation.

(b) *Classification.* Class II (performance standards).

**§ 880.6600 Ultraviolet (UV) radiation chamber disinfection device.**

(a) *Identification.* An ultraviolet (UV) radiation chamber disinfection device is intended for the low-level surface disinfection of non-porous equipment surfaces by dose-controlled UV irradiation. This classification does not include self-contained open chamber UV radiation disinfection devices intended for whole room disinfection in a health care environment.

(b) *Classification*—Class II (special controls). The special controls for this device are:

(1) Performance testing must demonstrate the following:

(i) The chamber's ability to control the UV radiation dose during operation.

(ii) The chamber's disinfection performance through microbial challenge testing.

(iii) Evidence that the equipment intended to be processed is UV compatible.

(iv) Validation of the cleaning and disinfection procedures.

(v) The ability of the device to continue to perform to all specification after cleaning and disinfection.

(vi) Whether the device generates ozone (if so, 21 CFR 801.415, Maximum acceptable level of ozone, applies).

(2) Appropriate software verification, validation, and hazard analysis must be performed.

(3) Appropriate analysis and/or testing must validate electrical safety, mechanical safety, and electromagnetic compatibility of the device in its intended use environment.

(4) The labeling must include:

(i) UV hazard warning labels.

(ii) Explanation of all displays and/or labeling on user interface.

(iii) Explanation of device safety interlocks.

(iv) Explanation of all disinfection cycle signals, cautions and warnings.

(v) Device operating procedures.

(vi) Identification of the expected UV lamp operational life and instructions for procedures on replacement of the UV lamp when needed.

(vii) Procedures to follow in case of UV lamp malfunction or failure.

(viii) Procedures for disposing of mercury-containing UV lamps, if applicable.

(ix) Identification of specific equipment that is compatible with the UV radiation dose generated by the device and that can safely undergo UV radiation low-level disinfection in the chamber device.

(x) Description of the required preparation of equipment for disinfection in the UV radiation chamber device.

(xi) Identification of the specific microbes used in successful performance testing of the device.

(xii) Validated instructions for cleaning and disinfection of the device.

[80 FR 72588, Nov. 20, 2015]

**§ 880.6710 Medical ultraviolet water purifier.**

(a) *Identification.* A medical ultraviolet water purifier is a device intended for medical purposes that is used to destroy bacteria in water by exposure to ultraviolet radiation.

(b) *Classification.* Class II (performance standards). The device is exempt from the premarket notification procedures in part 807, subpart E, of this

## § 880.6730

chapter subject to the limitations in § 880.9.

[45 FR 69682, Oct. 21, 1980, as amended at 83 FR 25915, June 5, 2018]

### § 880.6730 Body waste receptacle.

(a) *Identification.* A body waste receptacle is a device intended for medical purposes that is not attached to the body and that is used to collect the body wastes of a bed patient.

(b) *Classification.* Class I (general controls). The device is exempt from the premarket notification procedures in subpart E of part 807 of this chapter, subject to the limitations in § 880.9. The device also is exempt from the current good manufacturing practice requirements of the quality system regulation in part 820 of this chapter, with the exception of § 820.180, with respect to general requirements concerning records, and § 820.198, with respect to complaint files.

[66 FR 38806, July 25, 2001]

### § 880.6740 Vacuum-powered body fluid suction apparatus.

(a) *Identification.* A vacuum-powered body fluid suction apparatus is a device used to aspirate, remove, or sample body fluids. The device is powered by an external source of vacuum. This generic type of device includes vacuum regulators, vacuum collection bottles, suction catheters and tips, connecting flexible aspirating tubes, rigid suction tips, specimen traps, noninvasive tubing, and suction regulators (with gauge).

(b) *Classification.* Class II (special controls). The device is exempt from the premarket notification procedures in subpart E of part 807 of this chapter subject to § 880.9.

[45 FR 69682, Oct. 21, 1980, as amended at 63 FR 59229, Nov. 3, 1998]

### § 880.6760 Protective restraint.

(a) *Identification.* A protective restraint is a device, including but not limited to a wristlet, anklet, vest, mitt, straight jacket, body/limb holder, or other type of strap, that is intended for medical purposes and that limits the patient's movements to the extent necessary for treatment, examination, or protection of the patient or others.

## 21 CFR Ch. I (4–1–20 Edition)

(b) *Classification.* Class I (general controls). The device is exempt from the premarket notification procedures in subpart E of part 807 of this chapter subject to the limitations in § 880.9.

[61 FR 8439, Mar. 4, 1996, as amended at 66 FR 46952, Sept. 10, 2001; 84 FR 71815, Dec. 30, 2019]

### § 880.6775 Powered patient transfer device.

(a) *Identification.* A powered patient transfer device is a device consisting of a wheeled stretcher and a powered mechanism that has a broad, flexible band stretched over long rollers that can advance itself under a patient and transfer the patient with minimal disturbance in a horizontal position to the stretcher.

(b) *Classification.* Class II (special controls). The device is exempt from the premarket notification procedures in subpart E of part 807 of this chapter subject to § 880.9.

[45 FR 69682, Oct. 21, 1980, as amended at 63 FR 59229, Nov. 3, 1998]

### § 880.6785 Manual patient transfer device.

(a) *Identification.* A manual patient transfer device is a device consisting of a wheeled stretcher and a mechanism on which a patient can be placed so that the patient can be transferred with minimal disturbance in a horizontal position to the stretcher.

(b) *Classification.* Class I (general controls). The device is exempt from the premarket notification procedures in subpart E of part 807 of this chapter, subject to the limitations in § 880.9. The device is also exempt from the current good manufacturing practice requirements of the quality system regulation in part 820 of this chapter, with the exception of § 820.180, with respect to general requirements concerning records, and § 820.198, with respect to complaint files.

[45 FR 69682, Oct. 21, 1980, as amended at 66 FR 38807, July 25, 2001]

### § 880.6800 Washers for body waste receptacles.

(a) *Identification.* A washer for body waste receptacles is a device intended for medical purposes that is used to

clean and sanitize a body waste receptacle, such as a bedpan. The device consists of a wall-mounted plumbing fixture with a door through which a body waste receptacle is inserted. When the door is closed the body waste receptacle is cleaned by hot water, steam, or germicide.

(b) *Classification.* Class I (general controls). The device is exempt from the premarket notification procedures in subpart E of part 807 of this chapter, subject to the limitations in § 880.9. The device also is exempt from the current good manufacturing practice requirements of the quality system regulation in part 820 of this chapter, with the exception of § 820.180, with respect to general requirements concerning records, and § 820.198, with respect to complaint files.

[45 FR 69682, Oct. 21, 1980, as amended at 66 FR 38807, July 25, 2001]

**§ 880.6820 Medical disposable scissors.**

(a) *Identification.* Medical disposable scissors are disposable type general cutting devices intended for medical purposes. This generic type of device does not include surgical scissors.

(b) *Classification.* Class I (general controls). The device is exempt from the premarket notification procedures in subpart E of part 807 of this chapter, subject to the limitations in § 880.9.

[45 FR 69682, Oct. 21, 1980, as amended at 66 FR 38807, July 25, 2001]

**§ 880.6850 Sterilization wrap.**

(a) *Identification.* A sterilization wrap (pack, sterilization wrapper, bag, or accessories, is a device intended to be used to enclose another medical device that is to be sterilized by a health care provider. It is intended to allow sterilization of the enclosed medical device and also to maintain sterility of the enclosed device until used.

(b) *Classification.* Class II (performance standards).

**§ 880.6860 Ethylene oxide gas sterilizer.**

(a) *Identification.* An ethylene gas sterilizer is a nonportable device intended for use by a health care provider that uses ethylene oxide (ETO) to sterilize medical products.

(b) *Classification.* Class II (performance standards).

**§ 880.6870 Dry-heat sterilizer.**

(a) *Identification.* A dry-heat sterilizer is a device that is intended for use by a health care provider to sterilize medical products by means of dry heat.

(b) *Classification.* Class II (performance standards).

**§ 880.6880 Steam sterilizer.**

(a) *Identification.* A steam sterilizer (autoclave) is a device that is intended for use by a health care provider to sterilize medical products by means of pressurized steam.

(b) *Classification.* Class II (performance standards).

**§ 880.6885 Liquid chemical sterilants/high level disinfectants.**

(a) *Identification.* A liquid chemical sterilant/high level disinfectant is a germicide that is intended for use as the terminal step in processing critical and semicritical medical devices prior to patient use. Critical devices make contact with normally sterile tissue or body spaces during use. Semicritical devices make contact during use with mucous membranes or nonintact skin.

(b) *Classification.* Class II (special controls). Guidance on the Content and Format of Premarket Notification (510(k)) Submissions for Liquid Chemical Sterilants/High Level Disinfectants, and user information and training.

[65 FR 36325, June 8, 2000]

**§ 880.6890 General purpose disinfectants.**

(a) *Identification.* A general purpose disinfectant is a germicide intended to process noncritical medical devices and equipment surfaces. A general purpose disinfectant can be used to preclean or decontaminate critical or semicritical medical devices prior to terminal sterilization or high level disinfection. Noncritical medical devices make only topical contact with intact skin.

(b) *Classification.* Class I (general controls). The device is exempt from the premarket notification procedures in

## § 880.6900

subpart E of part 807 of this chapter subject to the limitations in § 880.9.

[65 FR 36326, June 8, 2000]

### § 880.6900 Hand-carried stretcher.

(a) *Identification.* A hand-carried stretcher is a device consisting of a lightweight frame, or of two poles with a cloth or metal platform, on which a patient can be carried.

(b) *Classification.* Class I (general controls). The device is exempt from the premarket notification procedures in subpart E of part 807 of this chapter, subject to the limitations in § 880.9. The device is also exempt from the current good manufacturing practice requirements of the quality system regulation in part 820 of this chapter, with the exception of § 820.180, with respect to general requirements concerning records, and § 820.198, with respect to complaint files.

[45 FR 69682, Oct. 21, 1980, as amended at 59 FR 63011, Dec. 7, 1994; 66 FR 38807, July 25, 2001]

### § 880.6910 Wheeled stretcher.

(a) *Identification.* A wheeled stretcher is a device consisting of a platform mounted on a wheeled frame that is designed to transport patients in a horizontal position. The device may have side rails, supports for fluid infusion equipment, and patient securement straps. The frame may be fixed or collapsible for use in an ambulance.

(b) *Classification.* Class II (special controls). The device is exempt from the premarket notification procedures in subpart E of part 807 of this chapter subject to § 880.9.

[45 FR 69682, Oct. 21, 1980, as amended at 63 FR 59229, Nov. 3, 1998]

### § 880.6920 Syringe needle introducer.

(a) *Identification.* A syringe needle introducer is a device that uses a spring-loaded mechanism to drive a hypodermic needle into a patient to a predetermined depth below the skin surface.

(b) *Classification.* Class II (performance standards).

### § 880.6960 Irrigating syringe.

(a) *Identification.* An irrigating syringe is a device intended for medical

## 21 CFR Ch. I (4–1–20 Edition)

purposes that consists of a bulb or a piston syringe with an integral or a detachable tube. The device is used to irrigate, withdraw fluid from, or instill fluid into, a body cavity or wound.

(b) *Classification.* Class I (general controls). The device is exempt from the premarket notification procedures in subpart E of part 807 of this chapter, subject to the limitations in § 880.9. If the device is not labeled or otherwise represented as sterile, it is also exempt from the current good manufacturing practice requirements of the quality system regulation in part 820 of this chapter, with the exception of § 820.180, with respect to general requirements concerning records, and § 820.198, with respect to complaint files.

[45 FR 69682, Oct. 21, 1980, as amended at 66 FR 38807, July 25, 2001]

### § 880.6970 Liquid crystal vein locator.

(a) *Identification.* A liquid crystal vein locator is a device used to indicate the location of a vein by revealing variations in the surface temperature of the skin by displaying the color changes of heat sensitive liquid crystals (cholesteric esters).

(b) *Classification.* Class I (general controls). The device is exempt from the premarket notification procedures in subpart E of part 807 of this chapter, subject to the limitations in § 880.9.

[45 FR 69682, Oct. 21, 1980, as amended at 54 FR 25050, June 12, 1989; 66 FR 38807, July 25, 2001]

### § 880.6980 Vein stabilizer.

(a) *Identification.* A vein stabilizer is a device consisting of a flat piece of plastic with two noninvasive prongs. The device is placed on the skin so that the prongs are on either side of a vein and hold it stable while a hypodermic needle is inserted into the vein.

(b) *Classification.* Class I (general controls). The device is exempt from the premarket notification procedures in subpart E of part 807 of this chapter, subject to the limitations in § 880.9. If the device is not labeled or otherwise represented as sterile, it is also exempt from the current good manufacturing practice requirements of the quality system regulation in part 820 of this chapter, with the exception of § 820.180,

with respect to general requirements concerning records, and §820.198, with respect to complaint files.

[45 FR 69682, Oct. 21, 1980, as amended at 66 FR 38807, July 25, 2001]

**§ 880.6990 Infusion stand.**

(a) *Identification.* The infusion stand is a stationary or movable stand intended to hold infusion liquids, infusion accessories, and other medical devices.

(b) *Classification.* Class I (general controls). The device is exempt from the premarket notification procedures in subpart E of part 807 of this chapter subject to the limitations in §880.9.

[63 FR 59718, Nov. 5, 1998]

**§ 880.6991 Medical washer.**

(a) *Identification.* A medical washer is a device that is intended for general medical purposes to clean and dry surgical instruments, anesthesia equipment, hollowware, and other medical devices.

(b) *Classification.* Class II (special controls). The special control for this device is the FDA guidance document entitled "Class II Special Controls Guidance Document: Medical Washers and Medical Washer-Disinfectors." The device is exempt from the premarket notification procedures in subpart E of part 807 of this chapter subject to §880.9.

[67 FR 69121, Nov. 15, 2002]

**§ 880.6992 Medical washer-disinfector.**

(a) *Identification.* A medical washer-disinfector is a device that is intended for general medical purposes to clean, decontaminate, disinfect, and dry surgical instruments, anesthesia equipment, hollowware, and other medical devices.

(b) *Classification.* Class II (special controls). The special control for this device is the FDA guidance document entitled "Class II Special Controls Guidance Document: Medical Washers and Medical Washer-Disinfectors."

(1) Medical washer-disinfectors that are intended to clean, high level disinfect, and dry surgical instruments, anesthesia equipment, hollowware, and other medical devices.

(2) Medical washer-disinfectors that are intended to clean, low or intermediate level disinfect, and dry surgical instruments, anesthesia equipment, hollowware, and other medical devices are exempt from the premarket notification procedures in subpart E of part 807 of this chapter subject to §880.9.

[67 FR 69121, Nov. 15, 2002]

**PART 882—NEUROLOGICAL DEVICES**

**Subpart A—General Provisions**

Sec.

882.1 Scope.

882.3 Effective dates of requirement for premarket approval.

882.9 Limitations of exemptions from section 510(k) of the Federal Food, Drug, and Cosmetic Act (the act).

**Subpart B—Neurological Diagnostic Devices**

882.1020 Rigidity analyzer.

882.1030 Ataxiagraph.

882.1200 Two-point discriminator.

882.1240 Echoencephalograph.

882.1275 Electroconductive media.

882.1310 Cortical electrode.

882.1320 Cutaneous electrode.

882.1330 Depth electrode.

882.1340 Nasopharyngeal electrode.

882.1350 Needle electrode.

882.1400 Electroencephalograph.

882.1410 Electroencephalograph electrode/lead tester.

882.1420 Electroencephalogram (EEG) signal spectrum analyzer.

882.1430 Electroencephalograph test signal generator.

882.1440 Neuropsychiatric interpretive electroencephalograph assessment aid.

882.1450 Brain injury adjunctive interpretive electroencephalograph assessment aid.

882.1460 Nystagmograph.

882.1470 Computerized cognitive assessment aid.

882.1471 Computerized cognitive assessment aid for concussion.

882.1480 Neurological endoscope.

882.1500 Esthesiometer.

882.1525 Tuning fork.

882.1540 Galvanic skin response measurement device.

882.1550 Nerve conduction velocity measurement device.

882.1560 Skin potential measurement device.

882.1561 Evoked photon image capture device.

882.1570 Powered direct-contact temperature measurement device.  
 882.1580 Non-electroencephalogram (EEG) physiological signal based seizure monitoring system.  
 882.1610 Alpha monitor.  
 882.1620 Intracranial pressure monitoring device.  
 882.1630 Cranial motion measurement device.  
 882.1700 Percussor.  
 882.1750 Pinwheel.  
 882.1790 Ocular plethysmograph.  
 882.1825 Rheoencephalograph.  
 882.1835 Physiological signal amplifier.  
 882.1845 Physiological signal conditioner.  
 882.1855 Electroencephalogram (EEG) telemetry system.  
 882.1870 Evoked response electrical stimulator.  
 882.1880 Evoked response mechanical stimulator.  
 882.1890 Evoked response photic stimulator.  
 882.1900 Evoked response auditory stimulator.  
 882.1925 Ultrasonic scanner calibration test block.  
 882.1935 Near Infrared (NIR) Brain Hematoma Detector.  
 882.1950 Tremor transducer.

#### Subparts C–D [Reserved]

#### Subpart E—Neurological Surgical Devices

882.4030 Skull plate anvil.  
 882.4060 Ventricular cannula.  
 882.4100 Ventricular catheter.  
 882.4125 Neurosurgical chair.  
 882.4150 Scalp clip.  
 882.4175 Aneurysm clip applier.  
 882.4190 Clip forming/cutting instrument.  
 882.4200 Clip removal instrument.  
 882.4215 Clip rack.  
 882.4250 Cryogenic surgical device.  
 882.4275 Dowel cutting instrument.  
 882.4300 Manual cranial drills, burrs, trephines, and their accessories.  
 882.4305 Powered compound cranial drills, burrs, trephines, and their accessories.  
 882.4310 Powered simple cranial drills, burrs, trephines, and their accessories.  
 882.4325 Cranial drill handpiece (brace).  
 882.4360 Electric cranial drill motor.  
 882.4370 Pneumatic cranial drill motor.  
 882.4400 Radiofrequency lesion generator.  
 882.4440 Neurosurgical headrests.  
 882.4460 Neurosurgical head holder (skull clamp).  
 882.4500 Cranioplasty material forming instrument.  
 882.4525 Microsurgical instrument.  
 882.4535 Nonpowered neurosurgical instrument.  
 882.4545 Shunt system implantation instrument.  
 882.4560 Stereotaxic instrument.

882.4600 Leukotome.  
 882.4650 Neurosurgical suture needle.  
 882.4700 Neurosurgical paddie.  
 882.4725 Radiofrequency lesion probe.  
 882.4750 Skull punch.  
 882.4800 Self-retaining retractor for neurosurgery.  
 882.4840 Manual rongeur.  
 882.4845 Powered rongeur.  
 882.4900 Skullplate screwdriver.

#### Subpart F—Neurological Therapeutic Devices

882.5030 Methyl methacrylate for aneurysmorrhaphy.  
 882.5050 Biofeedback device.  
 882.5070 Bite block.  
 882.5150 Intravascular occluding catheter.  
 882.5175 Carotid artery clamp.  
 882.5200 Aneurysm clip.  
 882.5225 Implanted malleable clip.  
 882.5235 Aversive conditioning device.  
 882.5250 Burr hole cover.  
 882.5275 Nerve cuff.  
 882.5300 Methyl methacrylate for cranioplasty.  
 882.5320 Preformed alterable cranioplasty plate.  
 882.5330 Preformed nonalterable cranioplasty plate.  
 882.5360 Cranioplasty plate fastener.  
 882.5500 Lesion temperature monitor.  
 882.5550 Central nervous system fluid shunt and components.  
 882.5600 Neurovascular mechanical thrombectomy device for acute ischemic stroke treatment.  
 882.5700 Thermal system for insomnia.  
 882.5800 Cranial electrotherapy stimulator.  
 882.5801 Computerized behavioral therapy device for psychiatric disorders.  
 882.5802 Transcranial magnetic stimulation system for neurological and psychiatric disorders and conditions.  
 882.5805 Repetitive transcranial magnetic stimulation system.  
 882.5808 Transcranial magnetic stimulator for headache.  
 882.5810 External functional neuromuscular stimulator.  
 882.5820 Implanted cerebellar stimulator.  
 882.5830 Implanted diaphragmatic/phrenic nerve stimulator.  
 882.5840 Implanted intracerebral/subcortical stimulator for pain relief.  
 882.5850 Implanted spinal cord stimulator for bladder evacuation.  
 882.5860 Implanted neuromuscular stimulator.  
 882.5870 Implanted peripheral nerve stimulator for pain relief.  
 882.5880 Implanted spinal cord stimulator for pain relief.  
 882.5890 Transcutaneous electrical nerve stimulator for pain relief.



## Food and Drug Administration, HHS

## § 882.3

- 882.5891 Transcutaneous electrical nerve stimulator to treat headache.
- 882.5892 External vagal nerve stimulator for headache.
- 882.5893 Thermal vestibular stimulator for headache.
- 882.5894 Limited output transcutaneous piezoelectric stimulator for skin reactions associated with insect bites.
- 882.5895 Vibratory counter-stimulation device.
- 882.5896 Percutaneous nerve stimulator for substance use disorders.
- 882.5897 External upper limb tremor stimulator.
- 882.5900 Preformed craniostomosis strip.
- 882.5910 Dura substitute.
- 882.5940 Electroconvulsive therapy device.
- 882.5950 Neurovascular embolization device.
- 882.5960 Skull tongs for traction.
- 882.5970 Cranial orthosis.
- 882.5975 Human dura mater.

AUTHORITY: 21 U.S.C. 351, 360, 360c, 360e, 360j, 360l, 371.

SOURCE: 44 FR 51730, Sept. 4, 1979, unless otherwise noted.

EDITORIAL NOTE: Nomenclature changes to part 882 appear at 73 FR 35341, June 23, 2008.

### Subpart A—General Provisions

#### § 882.1 Scope.

(a) This part sets forth the classification of neurological devices intended for human use that are in commercial distribution.

(b) The identification of a device in a regulation in this part is not a precise description of every device that is, or will be, subject to the regulation. A manufacturer who submits a premarket notification submission for a device under part 807 may not show merely that the device is accurately described by the section title and identification provisions of a regulation in this part, but shall state why the device is substantially equivalent to other devices, as required by § 807.87.

(c) To avoid duplicative listings, a neurological device that has two or more types of uses (e.g., used both as a diagnostic device and as a therapeutic device) is listed only in one subpart.

(d) References in this part to regulatory sections of the Code of Federal Regulations are to chapter I of title 21, unless otherwise noted.

(e) Guidance documents referenced in this part are available on the Internet at <http://www.fda.gov/MedicalDevices/>

*DeviceRegulationandGuidance/  
GuidanceDocuments/default.htm..*

[52 FR 17739, May 11, 1987, as amended at 68 FR 70436, Dec. 18, 2003; 78 FR 18233, Mar. 26, 2013]

#### § 882.3 Effective dates of requirement for premarket approval.

A device included in this part that is classified into class III (premarket approval) shall not be commercially distributed after the date shown in the regulation classifying the device unless the manufacturer has an approval under section 515 of the act (unless an exemption has been granted under section 520(g)(2) of the act). An approval under section 515 of the act consists of FDA's issuance of an order approving an application for premarket approval (PMA) for the device or declaring completed a product development protocol (PDP) for the device.

(a) Before FDA requires that a device commercially distributed before the enactment date of the amendments, or a device that has been found substantially equivalent to such a device, has an approval under section 515 of the act FDA must promulgate a regulation under section 515(b) of the act requiring such approval, except as provided in paragraph (b) of this section. Such a regulation under section 515(b) of the act shall not be effective during the grace period ending on the 90th day after its promulgation or on the last day of the 30th full calendar month after the regulation that classifies the device into class III is effective, whichever is later. See section 501(f)(2)(B) of the act. Accordingly, unless an effective date of the requirement for premarket approval is shown in the regulation for a device classified into class III in this part, the device may be commercially distributed without FDA's issuance of an order approving a PMA or declaring completed a PDP for the device. If FDA promulgates a regulation under section 515(b) of the act requiring premarket approval for a device, section, 501(f)(1)(A) of the act applies to the device.

(b) Any new, not substantially equivalent, device introduced into commercial distribution on or after May 28,

## § 882.9

## 21 CFR Ch. I (4–1–20 Edition)

1976, including a device formerly marketed that has been substantially altered, is classified by statute (section 513(f) of the act) into class III without any grace period and FDA must have issued an order approving a PMA or declaring completed a PDP for the device before the device is commercially distributed unless it is reclassified. If FDA knows that a device being commercially distributed may be a “new” device as defined in this section because of any new intended use or other reasons, FDA may codify the statutory classification of the device into class III for such new use. Accordingly, the regulation for such a class III device states that as of the enactment date of the amendments, May 28, 1976, the device must have an approval under section 515 of the act before commercial distribution.

[52 FR 17739, May 11, 1987]

### § 882.9 Limitations of exemptions from section 510(k) of the Federal Food, Drug, and Cosmetic Act (the act).

The exemption from the requirement of premarket notification (section 510(k) of the act) for a generic type of class I or II device is only to the extent that the device has existing or reasonably foreseeable characteristics of commercially distributed devices within that generic type or, in the case of in vitro diagnostic devices, only to the extent that misdiagnosis as a result of using the device would not be associated with high morbidity or mortality. Accordingly, manufacturers of any commercially distributed class I or II device for which FDA has granted an exemption from the requirement of premarket notification must still submit a premarket notification to FDA before introducing or delivering for introduction into interstate commerce for commercial distribution the device when:

- (a) The device is intended for a use different from the intended use of a legally marketed device in that generic type of device; e.g., the device is intended for a different medical purpose, or the device is intended for lay use where the former intended use was by health care professionals only;
- (b) The modified device operates using a different fundamental sci-

entific technology than a legally marketed device in that generic type of device; e.g., a surgical instrument cuts tissue with a laser beam rather than with a sharpened metal blade, or an in vitro diagnostic device detects or identifies infectious agents by using deoxyribonucleic acid (DNA) probe or nucleic acid hybridization technology rather than culture or immunoassay technology; or

(c) The device is an in vitro device that is intended:

(1) For use in the diagnosis, monitoring, or screening of neoplastic diseases with the exception of immunohistochemical devices;

(2) For use in screening or diagnosis of familial or acquired genetic disorders, including inborn errors of metabolism;

(3) For measuring an analyte that serves as a surrogate marker for screening, diagnosis, or monitoring life-threatening diseases such as acquired immune deficiency syndrome (AIDS), chronic or active hepatitis, tuberculosis, or myocardial infarction or to monitor therapy;

(4) For assessing the risk of cardiovascular diseases;

(5) For use in diabetes management;

(6) For identifying or inferring the identity of a microorganism directly from clinical material;

(7) For detection of antibodies to microorganisms other than immunoglobulin G (IgG) or IgG assays when the results are not qualitative, or are used to determine immunity, or the assay is intended for use in matrices other than serum or plasma;

(8) For noninvasive testing as defined in § 812.3(k) of this chapter; and

(9) For near patient testing (point of care).

[65 FR 2319, Jan. 14, 2000]

### Subpart B—Neurological Diagnostic Devices

#### § 882.1020 Rigidity analyzer.

(a) *Identification.* A rigidity analyzer is a device for quantifying the extent of the rigidity of a patient’s limb to determine the effectiveness of drugs or other treatments.

(b) *Classification.* Class II (special controls). The device is exempt from the premarket notification procedures in subpart E of part 807 of this chapter subject to the limitations in § 882.9.

[44 FR 51730, Sept. 4, 1979, as amended at 84 FR 71815, Dec. 30, 2019]

#### § 882.1030 Ataxiagraph.

(a) *Identification.* An ataxiagraph is a device used to determine the extent of ataxia (failure of muscular coordination) by measuring the amount of swaying of the body when the patient is standing erect and with eyes closed.

(b) *Classification.* Class I (general controls). Except when the device is intended to provide an interpretation or a clinical implication of the measurement, it is exempt from the premarket notification procedures in subpart E of part 807 of this chapter subject to the limitations in § 882.9.

[44 FR 51730, Sept. 4, 1979, as amended at 66 FR 46952, Sept. 10, 2001; 84 FR 71815, Dec. 30, 2019]

#### § 882.1200 Two-point discriminator.

(a) *Identification.* A two-point discriminator is a device with points used for testing a patient's touch discrimination.

(b) *Classification.* Class I (general controls). The device is exempt from the premarket notification procedures in subpart E of part 807 of this chapter subject to § 882.9. The device is also exempt from the current good manufacturing practice requirements of the quality system regulation in part 820 of this chapter, with the exception of § 820.180 of this chapter, with respect to general requirements concerning records, and § 820.198 of this chapter, with respect to complaint files.

[44 FR 51730, Sept. 4, 1979, as amended at 54 FR 25051, June 12, 1989; 65 FR 2319, Jan. 14, 2000]

#### § 882.1240 Echoencephalograph.

(a) *Identification.* An echoencephalograph is an ultrasonic scanning device (including A-scan, B-scan, and doppler systems) that uses noninvasive transducers for measuring intracranial interfaces and blood flow velocity to and in the head.

(b) *Classification.* Class II (performance standards).

#### § 882.1275 Electroconductive media.

(a) *Identification.* Electroconductive media are the conductive creams or gels used with external electrodes to reduce the impedance (resistance to alternating current) of the contact between the electrode surface and the skin.

(b) *Classification.* Class II (performance standards).

#### § 882.1310 Cortical electrode.

(a) *Identification.* A cortical electrode is an electrode which is temporarily placed on the surface of the brain for stimulating the brain or recording the brain's electrical activity.

(b) *Classification.* Class II (performance standards).

#### § 882.1320 Cutaneous electrode.

(a) *Identification.* A cutaneous electrode is an electrode that is applied directly to a patient's skin either to record physiological signals (e.g., the electroencephalogram) or to apply electrical stimulation.

(b) *Classification.* Class II (performance standards).

#### § 882.1330 Depth electrode.

(a) *Identification.* A depth electrode is an electrode used for temporary stimulation of, or recording electrical signals at, subsurface levels of the brain.

(b) *Classification.* Class II (performance standards).

#### § 882.1340 Nasopharyngeal electrode.

(a) *Identification.* A nasopharyngeal electrode is an electrode which is temporarily placed in the nasopharyngeal region for the purpose of recording electrical activity.

(b) *Classification.* Class II (performance standards).

#### § 882.1350 Needle electrode.

(a) *Identification.* A needle electrode is a device which is placed subcutaneously to stimulate or to record electrical signals.

(b) *Classification.* Class II (performance standards).

**§ 882.1400**

**21 CFR Ch. I (4–1–20 Edition)**

**§ 882.1400 Electroencephalograph.**

(a) *Identification.* An electroencephalograph is a device used to measure and record the electrical activity of the patient's brain obtained by placing two or more electrodes on the head.

(b) *Classification.* Class II (performance standards).

**§ 882.1410 Electroencephalograph electrode/lead tester.**

(a) *Identification.* An electroencephalograph electrode/lead tester is a device used for testing the impedance (resistance to alternating current) of the electrode and lead system of an electroencephalograph to assure that an adequate contact is made between the electrode and the skin.

(b) *Classification.* Class I (general controls). The device is exempt from the premarket notification procedures in subpart E of part 807 of this chapter subject to the limitations in § 882.9.

[44 FR 51730, Sept. 4, 1979, as amended at 61 FR 1123, Jan. 16, 1996; 66 FR 38807, July 25, 2001]

**§ 882.1420 Electroencephalogram (EEG) signal spectrum analyzer.**

(a) *Identification.* An electroencephalogram (EEG) signal spectrum analyzer is a device used to display the frequency content or power spectral density of the electroencephalogram (EEG) signal.

(b) *Classification.* Class I (general controls).

[44 FR 51730, Sept. 4, 1979, as amended at 66 FR 46953, Sept. 10, 2001]

**§ 882.1430 Electroencephalograph test signal generator.**

(a) *Identification.* An electroencephalograph test signal generator is a device used to test or calibrate an electroencephalograph.

(b) *Classification.* Class I (general controls). The device is exempt from the premarket notification procedures in subpart E of part 807 of this chapter subject to the limitations in § 882.9.

[44 FR 51730, Sept. 4, 1979, as amended at 59 FR 63011, Dec. 7, 1994; 66 FR 38807, July 25, 2001]

**§ 882.1440 Neuropsychiatric interpretive electroencephalograph assessment aid.**

(a) *Identification.* The neuropsychiatric interpretive electroencephalograph assessment aid is a prescription device that uses a patient's electroencephalograph (EEG) to provide an interpretation of the patient's neuropsychiatric condition. The neuropsychiatric interpretive EEG assessment aid is used only as an assessment aid for a medical condition for which there exists other valid methods of diagnosis.

(b) *Classification.* Class II (special controls). The special controls for this device are:

(1) The technical parameters of the device, hardware and software, must be fully characterized and must demonstrate a reasonable assurance of safety and effectiveness.

(i) Hardware specifications must be provided. Appropriate verification, validation, and hazard analysis must be performed.

(ii) Software, including any proprietary algorithm(s) used by the device to arrive at its interpretation of the patient's condition, must be described in detail in the software requirements specification and software design specification. Appropriate software verification, validation, and hazard analysis must be performed.

(2) The device parts that contact the patient must be demonstrated to be biocompatible.

(3) The device must be designed and tested for electrical safety, electromagnetic compatibility, thermal, and mechanical safety.

(4) Clinical performance testing must demonstrate the accuracy, precision, reproducibility, of determining the EEG-based interpretation, including any specified equivocal zones (cutoffs).

(5) Clinical performance testing must demonstrate the ability of the device to function as an assessment aid for the medical condition for which the device is indicated. Performance measures must demonstrate device performance characteristics per the intended use in the intended use environment. Performance measurements must include sensitivity, specificity, positive

predictive value, and negative predictive value per the device intended use. Repeatability of measurements must be demonstrated using interclass correlation coefficients and illustrated by qualitative scatter plot(s).

(6) The device design must include safeguards to prevent use of the device as a stand-alone diagnostic.

(7) The labeling must include the following information:

(i) A warning that the device is not to be used as a stand-alone diagnostic.

(ii) A detailed summary of the clinical performance testing, including any adverse events and complications.

(iii) The qualifications and training requirements for device users including technicians and clinicians.

(iv) The intended use population and the intended use environment.

(v) Any instructions technicians should convey to patients regarding the collection of EEG data.

(vi) Information allowing clinicians to gauge clinical risk associated with integrating the EEG interpretive assessment aid into their diagnostic pathway.

(vii) Where appropriate, validated methods and instructions for reprocessing of any reusable components.

[79 FR 9085, Feb. 18, 2014]

**§ 882.1450 Brain injury adjunctive interpretive electroencephalograph assessment aid.**

(a) *Identification.* A brain injury adjunctive interpretive electroencephalograph assessment aid is a prescription device that uses a patient's electroencephalograph (EEG) to provide an interpretation of the structural condition of the patient's brain in the setting of trauma. A brain injury adjunctive interpretive EEG assessment aid is for use as an adjunct to standard clinical practice only as an assessment aid for a medical condition for which there exists other valid methods of diagnosis.

(b) *Classification.* Class II (special controls). The special controls for this device are:

(1) The technical parameters of the device, hardware and software, must be fully characterized and include the following information:

(i) Hardware specifications must be provided. Appropriate verification, validation, and hazard analysis must be performed.

(ii) Software, including any proprietary algorithm(s) used by the device to arrive at its interpretation of the patient's condition, must be described in detail in the software requirements specification (SRS) and software design specification (SDS). Appropriate software verification, validation, and hazard analysis must be performed.

(2) The device parts that contact the patient must be demonstrated to be biocompatible.

(3) The device must be designed and tested for electrical safety, electromagnetic compatibility (EMC), thermal, and mechanical safety.

(4) Clinical performance testing must demonstrate the accuracy, precision-repeatability and reproducibility, of determining the EEG-based interpretation, including any specified equivocal zones (cutoffs).

(5) Clinical performance testing must demonstrate the ability of the device to function as an assessment aid for the medical condition for which the device is indicated. Performance measures must demonstrate device performance characteristics per the intended use in the intended use environment. Performance measurements must include sensitivity, specificity, positive predictive value (PPV), and negative predictive value (NPV) with respect to the study prevalence per the device intended use.

(6) The device design must include safeguards to ensure appropriate clinical interpretation of the device output (*e.g.*, use in appropriate patient population, or for appropriate clinical decision).

(7) The labeling and training information must include:

(i) A warning that the device is not to be used as a stand-alone diagnostic.

(ii) A detailed summary of the clinical performance testing, including any adverse events and complications.

(iii) The intended use population and the intended use environment.

(iv) Any instructions technicians should convey to patients regarding the collection of EEG data.

**§ 882.1460**

**21 CFR Ch. I (4–1–20 Edition)**

(v) Information allowing clinicians to gauge clinical risk associated with integrating the EEG interpretive assessment aid into their diagnostic pathway.

(vi) Information allowing clinicians to understand how to integrate the device output into their diagnostic pathway when the device is unable to provide a classification or final result.

[80 FR 16268, Mar. 27, 2015]

**§ 882.1460 Nystagmograph.**

(a) *Identification.* A nystagmograph is a device used to measure, record, or visually display the involuntary movements (nystagmus) of the eyeball.

(b) *Classification.* Class II (performance standards).

**§ 882.1470 Computerized cognitive assessment aid.**

(a) *Identification.* The computerized cognitive assessment aid is a prescription device that uses an individual's score(s) on a battery of cognitive tasks to provide an interpretation of the current level of cognitive function. The computerized cognitive assessment aid is used only as an assessment aid to determine level of cognitive functioning for which there exists other valid methods of cognitive assessment and does not identify the presence or absence of clinical diagnoses. The computerized cognitive assessment aid is not intended as a stand-alone or adjunctive diagnostic device.

(b) *Classification.* Class II (special controls). Except when the computerized cognitive assessment aid is intended for diagnostic assessment of specific diseases or conditions and relies on inputs from visual cues, auditory cues, and/or functional use of the hand, the device is exempt from the premarket notification procedures in subpart E of part 807 of this chapter subject to the limitations in § 882.9. The special control(s) for this device are:

(1) The technical parameters of the device's hardware and software must be fully characterized and be accompanied by appropriate non-clinical testing:

(i) Hardware specifications must be provided. Appropriate verification, validation, and hazard analysis must be performed.

(ii) Software, including any proprietary algorithm(s) used by the device to arrive at its interpretation of the patient's cognitive function, must be described in detail in the software requirements specification (SRS) and software design specification (SDS). Appropriate software verification, validation, and hazard analysis must be performed.

(2) The device must be designed and tested for electrical safety.

(3) The labeling must include:

(i) A summary of any testing conducted to demonstrate how the device functions as an interpretation of the current level of cognitive function. The summary of testing must include the following, if available: Any expected or observed adverse events and complications; any performance measurements including sensitivity, specificity, positive predictive value (PPV), and negative predictive value (NPV) per the devices intended use; a description of the repeatability of measurements; a description of how the cut-off values for categorization of measurements were determined; and a description of the construct validity of the device.

(ii) A warning that the device does not identify the presence or absence of clinical diagnoses.

(iii) A warning that the device is not a stand-alone diagnostic.

(iv) The intended use population and the intended use environment.

(v) Any instructions technicians must convey to patients regarding the administration of the test and collection of cognitive test data.

[80 FR 49138, Aug. 17, 2015, as amended at 84 FR 71815, Dec. 30, 2019]

**§ 882.1471 Computerized cognitive assessment aid for concussion.**

(a) *Identification.* The computerized cognitive assessment aid for concussion is a prescription device that uses an individual's score(s) on a battery of cognitive tasks to provide an indication of the current level of cognitive function in response to concussion. The computerized cognitive assessment aid for concussion is used only as an assessment aid in the management of concussion to determine cognitive function for patients after a potential

concussive event where other diagnostic tools are available and does not identify the presence or absence of concussion. It is not intended as a stand-alone diagnostic device.

(b) *Classification.* Class II (special controls). The special controls for this device are:

(1) Software, including any proprietary algorithm(s) used by the device to arrive at its interpretation of the patient's cognitive function, must be described in detail in the software requirements specification (SRS) and software design specification (SDS). Software verification, validation, and hazard analysis must be performed.

(2) Clinical performance data must be provided that demonstrates how the device functions as an interpretation of the current level of cognitive function in an individual that has recently received an injury that causes concern about a possible concussion. The testing must:

(i) Evaluate device output and clinical interpretation.

(ii) Evaluate device test-retest reliability of the device output.

(iii) Evaluate construct validity of the device cognitive assessments.

(iv) Describe the construction of the normative database, which includes the following:

(A) How the clinical workup was completed to establish a "normal" population, including the establishment of inclusion and exclusion criteria.

(B) Statistical methods and model assumptions used.

(3) The labeling must include:

(i) A summary of any clinical testing conducted to demonstrate how the device functions as an interpretation of the current level of cognitive function in a patient that has recently received an injury that causes concern about a possible concussion. The summary of testing must include the following:

(A) Device output and clinical interpretation.

(B) Device test-retest reliability of the device output.

(C) Construct validity of the device cognitive assessments.

(D) A description of the normative database, which includes the following:

(J) How the clinical workup was completed to establish a "normal" popu-

lation, including the establishment of inclusion and exclusion criteria.

(2) How normal values will be reported to the user.

(3) Representative screen shots and reports that will be generated to provide the user results and normative data.

(4) Statistical methods and model assumptions used.

(5) Whether or not the normative database was adjusted due to differences in age and gender.

(ii) A warning that the device should only be used by health care professionals who are trained in concussion management.

(iii) A warning that the device does not identify the presence or absence of concussion or other clinical diagnoses.

(iv) A warning that the device is not a stand-alone diagnostic.

(v) Any instructions technicians must convey to patients regarding the administration of the test and collection of cognitive test data.

[81 FR 87811, Dec. 6, 2016]

#### § 882.1480 Neurological endoscope.

(a) *Identification.* A neurological endoscope is an instrument with a light source used to view the inside of the ventricles of the brain.

(b) *Classification.* Class II (performance standards).

#### § 882.1500 Esthesiometer.

(a) *Identification.* An esthesiometer is a mechanical device which usually consists of a single rod or fiber which is held in the fingers of the physician or other examiner and which is used to determine whether a patient has tactile sensitivity.

(b) *Classification.* Class I (general controls). The device is exempt from the premarket notification procedures in subpart E of part 807 of this chapter subject to § 882.9. The device is also exempt from the current good manufacturing practice requirements of the quality system regulation in part 820 of this chapter, with the exception of § 820.180 of this chapter, with respect to general requirements concerning

## § 882.1525

records, and § 820.198 of this chapter, with respect to complaint files.

[44 FR 51730, Sept. 4, 1979, as amended at 54 FR 25051, June 12, 1989; 65 FR 2319, Jan. 14, 2000]

## § 882.1525 Tuning fork.

(a) *Identification.* A tuning fork is a mechanical device which resonates at a given frequency and is used to diagnose hearing disorders and to test for vibratory sense.

(b) *Classification.* Class I (general controls). The device is exempt from the premarket notification procedures in subpart E of part 807 of this chapter subject to the limitations in § 882.9. The device is also exempt from the current good manufacturing practice requirements of the quality system regulation in part 820 of this chapter, of this chapter, with the exception of § 820.180, with respect to general requirements concerning records, and § 820.198, with respect to complaint files.

[44 FR 51730, Sept. 4, 1979, as amended at 54 FR 25051, June 12, 1989; 66 FR 38807, July 25, 2001]

## § 882.1540 Galvanic skin response measurement device.

(a) *Identification.* A galvanic skin response measurement device is a device used to determine autonomic responses as psychological indicators by measuring the electrical resistance of the skin and the tissue path between two electrodes applied to the skin.

(b) *Classification.* Class II (special controls). The device is exempt from the premarket notification procedures in subpart E of part 807 of this chapter subject to the limitations in § 882.9.

[44 FR 51730, Sept. 4, 1979, as amended at 84 FR 71815, Dec. 30, 2019]

## § 882.1550 Nerve conduction velocity measurement device.

(a) *Identification.* A nerve conduction velocity measurement device is a device which measures nerve conduction time by applying a stimulus, usually to a patient's peripheral nerve. This device includes the stimulator and the electronic processing equipment for measuring and displaying the nerve conduction time.

## 21 CFR Ch. I (4–1–20 Edition)

(b) *Classification.* Class II (performance standards).

## § 882.1560 Skin potential measurement device.

(a) *Identification.* A skin potential measurement device is a general diagnostic device used to measure skin voltage by means of surface skin electrodes.

(b) *Classification.* Class II (special controls). The device is exempt from the premarket notification procedures in subpart E of part 807 of this chapter subject to the limitations in § 882.9.

[44 FR 51730, Sept. 4, 1979, as amended at 84 FR 71815, Dec. 30, 2019]

## § 882.1561 Evoked photon image capture device.

(a) *Identification.* An evoked photon image capture device is a prescription, electrically powered device intended for use as a noninvasive measurement tool that applies electricity to detect electrophysiological signals emanating from the skin, which are reported numerically and as images without clinical interpretation. The device is not intended for diagnostic purposes.

(b) *Classification.* Class I (general controls). The device is exempt from the premarket notification procedures in subpart E of part 807 of this chapter, subject to the limitations in § 882.9.

[81 FR 67155, Sept. 30, 2016]

## § 882.1570 Powered direct-contact temperature measurement device.

(a) *Identification.* A powered direct-contact temperature measurement device is a device which contains a power source and is used to measure differences in temperature between two points on the body.

(b) *Classification.* Class II (performance standards).

## § 882.1580 Non-electroencephalogram (EEG) physiological signal based seizure monitoring system.

(a) *Identification.* A non-electroencephalogram (non-EEG) physiological signal based seizure monitoring system is a noninvasive prescription device that collects physiological signals other than EEG to identify physiological signals that may be associated with a seizure.



(b) *Classification.* Class II (special controls). The special controls for this device are:

(1) The technical parameters of the device, hardware and software, must be fully characterized and include the following information:

(i) Hardware specifications must be provided. Appropriate verification, validation, and hazard analysis must be performed.

(ii) Software, including any proprietary algorithm(s) used by the device to achieve its intended use, must be described in detail in the Software Requirements Specification (SRS) and Software Design Specification (SDS). Appropriate software verification, validation, and hazard analysis must be performed.

(2) The patient-contacting components of the device must be demonstrated to be biocompatible.

(3) The device must be designed and tested for electrical, thermal, and mechanical safety and electromagnetic compatibility (EMC).

(4) Clinical performance testing must demonstrate the ability of the device to function as an assessment aid for monitoring for seizure-related activity in the intended population and for the intended use setting. Performance measurements must include positive percent agreement and false alarm rate.

(5) Training must be provided for intended users that includes information regarding the proper use of the device and factors that may affect the collection of the physiologic data.

(6) The labeling must include health care professional labeling and patient-caregiver labeling. The health care professional and the patient-caregiver labeling must include the following information:

(i) A detailed summary of the clinical performance testing, including any adverse events and complications.

(ii) Any instructions technicians and clinicians should convey to patients and caregivers regarding the proper use of the device and factors that may affect the collection of the physiologic data.

(iii) Instructions to technicians and clinicians regarding how to set the de-

vice threshold to achieve the intended performance of the device.

[82 FR 50082, Oct. 30, 2017]

**§ 882.1610 Alpha monitor.**

(a) *Identification.* An alpha monitor is a device with electrodes that are placed on a patient's scalp to monitor that portion of the electroencephalogram which is referred to as the alpha wave.

(b) *Classification.* Class II (performance standards).

**§ 882.1620 Intracranial pressure monitoring device.**

(a) *Identification.* An intracranial pressure monitoring device is a device used for short-term monitoring and recording of intracranial pressures and pressure trends. The device includes the transducer, monitor, and interconnecting hardware.

(b) *Classification.* Class II (performance standards).

**§ 882.1630 Cranial motion measurement device.**

(a) *Identification.* A cranial motion measurement device is a prescription device that utilizes accelerometers to measure the motion or acceleration of the skull. These measurements are not to be used for diagnostic purposes.

(b) *Classification.* Class II (special controls). The special controls for this device are:

(1) The technical parameters of the device, hardware and software, must be fully characterized and include the following information:

(i) Hardware specifications must be provided. Additionally, verification and validation testing as well as a hazard analysis must be performed.

(ii) Software must be described in detail in the Software Requirements Specification (SRS) and Software Design Specification (SDS). Additionally, software verification and validation testing as well as a hazard analysis must be performed.

(2) The device parts that contact the patient must be demonstrated to be biocompatible.

(3) The device must be designed and tested for electrical, thermal, and mechanical safety, and electromagnetic compatibility (EMC).

## § 882.1700

(4) Clinical performance testing must demonstrate the accuracy, precision, stability, and repeatability of measuring cranial motion per the intended use in the intended use environment.

(5) The labeling must include:

(i) The intended use population and the intended use environment.

(ii) Instructions for technicians to convey to patients regarding the collection of cranial acceleration data to ensure device measurement accuracy, precision, stability, and repeatability.

(iii) Information allowing clinicians to understand potential sources of variability in the measurement to help recognize and identify changes in the measurement.

[82 FR 35071, July 28, 2017]

## § 882.1700 Percussor.

(a) *Identification.* A percussor is a small hammerlike device used by a physician to provide light blows to a body part. A percussor is used as a diagnostic aid during physical examinations.

(b) *Classification.* Class I (general controls). The device is exempt from the premarket notification procedures in subpart E of part 807 of this chapter subject to the limitations in § 882.9. The device is also exempt from the current good manufacturing practice requirements of the quality system regulation in part 820 of this chapter, with the exception of § 820.180, with respect to general requirements concerning records, and § 820.198, with respect to complaint files.

[44 FR 51730, Sept. 4, 1979, as amended at 54 FR 25051, June 12, 1989; 59 FR 63011, Dec. 7, 1994; 66 FR 38807, July 25, 2001]

## § 882.1750 Pinwheel.

(a) *Identification.* A pinwheel is a device with sharp points on a rotating wheel used for testing pain sensation.

(b) *Classification.* Class I (general controls). The device is exempt from the premarket notification procedures in subpart E of part 807 of this chapter subject to § 882.9.

[44 FR 51730, Sept. 4, 1979, as amended at 54 FR 25051, June 12, 1989; 65 FR 2319, Jan. 14, 2000]

## 21 CFR Ch. I (4–1–20 Edition)

## § 882.1790 Ocular plethysmograph.

(a) *Identification.* An ocular plethysmograph is a device used to measure or detect volume changes in the eye produced by pulsations of the artery, to diagnose carotid artery occlusive disease (restrictions on blood flow in the carotid artery).

(b) *Classification.* Class III (premarket approval).

(c) *Date PMA or notice of completion of PDP is required.* A PMA or notice of completion of a PDP is required to be filed with the Food and Drug Administration on or before September 21, 2004, for any ocular plethysmograph that was in commercial distribution before May 28, 1976. Any other ocular plethysmograph shall have an approved PMA or declared completed PDP in effect before being placed in commercial distribution.

[44 FR 51730, Sept. 4, 1979, as amended at 52 FR 17739, May 11, 1987; 69 FR 34920, June 23, 2004]

## § 882.1825 Rheoencephalograph.

(a) *Identification.* A rheoencephalograph is a device used to estimate a patient's cerebral circulation (blood flow in the brain) by electrical impedance methods with direct electrical connections to the scalp or neck area.

(b) *Classification.* Class III (premarket approval).

(c) *Date PMA or notice of completion of a PDP is required.* A PMA or a notice of completion of a PDP is required to be filed with the Food and Drug Administration on or before December 26, 1996 for any rheoencephalograph that was in commercial distribution before May 28, 1976, or that has, on or before December 26, 1996 been found to be substantially equivalent to a rheoencephalograph that was in commercial distribution before May 28, 1976. Any other rheoencephalograph shall have an approved PMA or a declared completed PDP in effect before being placed in commercial distribution.

[44 FR 51730, Sept. 4, 1979, as amended at 52 FR 17740, May 11, 1987; 61 FR 50708, Sept. 27, 1996]

**Food and Drug Administration, HHS**

**§ 882.1935**

**§ 882.1835 Physiological signal amplifier.**

(a) *Identification.* A physiological signal amplifier is a general purpose device used to electrically amplify signals derived from various physiological sources (e.g., the electroencephalogram).

(b) *Classification.* Class II (performance standards).

**§ 882.1845 Physiological signal conditioner.**

(a) *Identification.* A physiological signal conditioner is a device such as an integrator or differentiator used to modify physiological signals for recording and processing.

(b) *Classification.* Class II (performance standards).

**§ 882.1855 Electroencephalogram (EEG) telemetry system.**

(a) *Identification.* An electroencephalogram (EEG) telemetry system consists of transmitters, receivers, and other components used for remotely monitoring or measuring EEG signals by means of radio or telephone transmission systems.

(b) *Classification.* Class II (special controls). The device is exempt from the premarket notification procedures in subpart E of part 807 of this chapter subject to the limitations in § 882.9.

[44 FR 51730, Sept. 4, 1979, as amended at 84 FR 71815, Dec. 30, 2019]

**§ 882.1870 Evoked response electrical stimulator.**

(a) *Identification.* An evoked response electrical stimulator is a device used to apply an electrical stimulus to a patient by means of skin electrodes for the purpose of measuring the evoked response.

(b) *Classification.* Class II (performance standards).

**§ 882.1880 Evoked response mechanical stimulator.**

(a) *Identification.* An evoked response mechanical stimulator is a device used to produce a mechanical stimulus or a series of mechanical stimuli for the purpose of measuring a patient's evoked response.

(b) *Classification.* Class II (performance standards).

**§ 882.1890 Evoked response photic stimulator.**

(a) *Identification.* An evoked response photic stimulator is a device used to generate and display a shifting pattern or to apply a brief light stimulus to a patient's eye for use in evoked response measurements or for electroencephalogram (EEG) activation.

(b) *Classification.* Class II (performance standards).

**§ 882.1900 Evoked response auditory stimulator.**

(a) *Identification.* An evoked response auditory stimulator is a device that produces a sound stimulus for use in evoked response measurements or electroencephalogram activation.

(b) *Classification.* Class II (performance standards).

**§ 882.1925 Ultrasonic scanner calibration test block.**

(a) *Identification.* An ultrasonic scanner calibration test block is a block of material with known properties used to calibrate ultrasonic scanning devices (e.g., the echoencephalograph).

(b) *Classification.* Class I (general controls). The device is exempt from the premarket notification procedures in subpart E of part 807 of this chapter subject to the limitations in § 882.9.

[44 FR 51730, Sept. 4, 1979, as amended at 59 FR 63011, Dec. 7, 1994; 66 FR 38807, July 25, 2001]

**§ 882.1935 Near Infrared (NIR) Brain Hematoma Detector.**

(a) *Identification.* A Near Infrared (NIR) Brain Hematoma Detector is a noninvasive device that employs near-infrared spectroscopy that is intended to be used to evaluate suspected brain hematomas.

(b) *Classification.* Class II (special controls). The special controls for this device are:

(1) The sale, distribution, and use of this device are restricted to prescription use in accordance with § 801.109 of this chapter;

(2) The labeling must include specific instructions and the clinical training needed for the safe use of this device;

**§ 882.1950**

(3) Appropriate analysis/testing should validate electromagnetic compatibility (EMC), electrical safety, and battery characteristics;

(4) Performance data should validate accuracy and precision and safety features;

(5) Any elements of the device that may contact the patient should be demonstrated to be biocompatible; and,

(6) Appropriate software verification, validation, and hazard analysis should be performed.

[77 FR 16927, Mar. 23, 2012]

**§ 882.1950 Tremor transducer.**

(a) *Identification.* A tremor transducer is a device used to measure the degree of tremor caused by certain diseases.

(b) *Classification.* Class II (performance standards).

**Subparts C–D [Reserved]**

**Subpart E—Neurological Surgical Devices**

**§ 882.4030 Skull plate anvil.**

(a) *Identification.* A skull plate anvil is a device used to form alterable skull plates in the proper shape to fit the curvature of a patient's skull.

(b) *Classification.* Class I (general controls). The device is exempt from the premarket notification procedures in subpart E of part 807 of this chapter subject to the limitations in § 882.9.

[44 FR 51730, Sept. 4, 1979, as amended at 59 FR 63011, Dec. 7, 1994; 66 FR 38808, July 25, 2001]

**§ 882.4060 Ventricular cannula.**

(a) *Identification.* A ventricular cannula is a device used to puncture the ventricles of the brain for aspiration or for injection. This device is frequently referred to as a ventricular needle.

(b) *Classification.* Class I (general controls). The device is exempt from the premarket notification procedures in subpart E of part 807 of this chapter subject to the limitations in § 882.9.

[44 FR 51730, Sept. 4, 1979, as amended at 65 FR 2319, Jan. 14, 2000; 84 FR 71815, Dec. 30, 2019]

**21 CFR Ch. I (4–1–20 Edition)**

**§ 882.4100 Ventricular catheter.**

(a) *Identification.* A ventricular catheter is a device used to gain access to the cavities of the brain for injection of material into, or removal of material from, the brain.

(b) *Classification.* Class II (performance standards).

**§ 882.4125 Neurosurgical chair.**

(a) *Identification.* A neurosurgical chair is an operating room chair used to position and support a patient during neurosurgery.

(b) *Classification.* Class I (general controls). The device is exempt from the premarket notification procedures in subpart E of part 807 of this chapter subject to the limitations in § 882.9.

[44 FR 51730, Sept. 4, 1979, as amended at 59 FR 63012, Dec. 7, 1994; 66 FR 38808, July 25, 2001]

**§ 882.4150 Scalp clip.**

(a) *Identification.* A scalp clip is a plastic or metal clip used to stop bleeding during surgery on the scalp.

(b) *Classification.* Class II (performance standards).

**§ 882.4175 Aneurysm clip applier.**

(a) *Identification.* An aneurysm clip applier is a device used by the surgeon for holding and applying intracranial aneurysm clips.

(b) *Classification.* Class II (performance standards).

**§ 882.4190 Clip forming/cutting instrument.**

(a) *Identification.* A clip forming/cutting instrument is a device used by the physician to make tissue clips from wire stock.

(b) *Classification.* Class I. The device is exempt from the premarket notification procedures in subpart E of part 807 of this chapter.

[44 FR 51730, Sept. 4, 1979, as amended at 59 FR 63012, Dec. 7, 1994]

**§ 882.4200 Clip removal instrument.**

(a) *Identification.* A clip removal instrument is a device used to remove surgical clips from the patient.

(b) *Classification.* Class I (general controls). The device is exempt from the premarket notification procedures in

## Food and Drug Administration, HHS

## § 882.4400

subpart E of part 807 of this chapter subject to the limitations in § 882.9.

[44 FR 51730, Sept. 4, 1979, as amended at 59 FR 63012, Dec. 7, 1994; 66 FR 38808, July 25, 2001]

### § 882.4215 Clip rack.

(a) *Identification.* A clip rack is a device used to hold or store surgical clips during surgery.

(b) *Classification.* Class I (general controls). The device is exempt from the premarket notification procedures in subpart E of part 807 of this chapter subject to the limitations in § 882.9.

[44 FR 51730, Sept. 4, 1979, as amended at 54 FR 25051, June 12, 1989; 59 FR 63012, Dec. 7, 1994; 66 FR 38808, July 25, 2001]

### § 882.4250 Cryogenic surgical device.

(a) *Identification.* A cryogenic surgical device is a device used to destroy nervous tissue or produce lesions in nervous tissue by the application of extreme cold to the selected site.

(b) *Classification.* Class II (performance standards).

### § 882.4275 Dowel cutting instrument.

(a) *Identification.* A dowel cutting instrument is a device used to cut dowels of bone for bone grafting.

(b) *Classification.* Class II (performance standards).

### § 882.4300 Manual cranial drills, burrs, trephines, and their accessories

(a) *Identification.* Manual cranial drills, burrs, trephines, and their accessories are bone cutting and drilling instruments that are used without a power source on a patient's skull.

(b) *Classification.* Class II (performance standards).

### § 882.4305 Powered compound cranial drills, burrs, trephines, and their accessories.

(a) *Identification.* Powered compound cranial drills, burrs, trephines, and their accessories are bone cutting and drilling instruments used on a patient's skull. The instruments employ a clutch mechanism to disengage the tip of the instrument after penetrating the skull to prevent plunging of the tip into the brain.

(b) *Classification.* Class II (performance standards).

### § 882.4310 Powered simple cranial drills, burrs, trephines, and their accessories.

(a) *Identification.* Powered simple cranial drills, burrs, trephines, and their accessories are bone cutting and drilling instruments used on a patient's skull. The instruments are used with a power source but do not have a clutch mechanism to disengage the tip after penetrating the skull.

(b) *Classification.* Class II (performance standards).

### § 882.4325 Cranial drill handpiece (brace).

(a) *Identification.* A cranial drill handpiece (brace) is a hand holder, which is used without a power source, for drills, burrs, trephines, or other cutting tools that are used on a patient's skull.

(b) *Classification.* Class I (general controls). The device is exempt from the premarket notification procedures in subpart E of part 807 of this chapter subject to the limitations in § 882.9.

[44 FR 51730, Sept. 4, 1979, as amended at 61 FR 1123, Jan. 16, 1996; 66 FR 38808, July 25, 2001]

### § 882.4360 Electric cranial drill motor.

(a) *Identification.* An electric cranial drill motor is an electrically operated power source used with removable rotating surgical cutting tools or drill bits on a patient's skull.

(b) *Classification.* Class II (performance standards).

### § 882.4370 Pneumatic cranial drill motor.

(a) *Identification.* A pneumatic cranial drill motor is a pneumatically operated power source used with removable rotating surgical cutting tools or drill bits on a patient's skull.

(b) *Classification.* Class II (performance standards).

### § 882.4400 Radiofrequency lesion generator.

(a) *Identification.* A radiofrequency lesion generator is a device used to produce lesions in the nervous system or other tissue by the direct application of radiofrequency currents to selected sites.

(b) *Classification.* Class II (performance standards).

## § 882.4440

### § 882.4440 Neurosurgical headrests.

(a) *Identification.* A neurosurgical headrest is a device used to support the patient's head during a surgical procedure.

(b) *Classification.* Class I (general controls). The device is exempt from the premarket notification procedures in subpart E of part 807 of this chapter subject to the limitations in § 882.9.

[44 FR 51730, Sept. 4, 1979, as amended at 59 FR 63012, Dec. 7, 1994; 66 FR 38808, July 25, 2001]

### § 882.4460 Neurosurgical head holder (skull clamp).

(a) *Identification.* A neurosurgical head holder (skull clamp) is a device used to clamp the patient's skull to hold head and neck in a particular position during surgical procedures.

(b) *Classification.* Class II (performance standards).

### § 882.4500 Cranioplasty material forming instrument.

(a) *Identification.* A cranioplasty material forming instrument is a roller used in the preparation and forming of cranioplasty (skull repair) materials.

(b) *Classification.* Class I (general controls). The device is exempt from the premarket notification procedures in subpart E of part 807 of this chapter subject to the limitations in § 882.9.

[44 FR 51730, Sept. 4, 1979, as amended at 59 FR 63012, Dec. 7, 1994; 66 FR 38808, July 25, 2001]

### § 882.4525 Microsurgical instrument.

(a) *Identification.* A microsurgical instrument is a nonpowered surgical instrument used in neurological microsurgery procedures.

(b) *Classification.* Class I (general controls). The device is exempt from the premarket notification procedures in subpart E of part 807 of this chapter subject to the limitations in § 882.9.

[44 FR 51730, Sept. 4, 1979, as amended at 59 FR 63012, Dec. 7, 1994; 66 FR 38808, July 25, 2001]

### § 882.4535 Nonpowered neurosurgical instrument.

(a) *Identification.* A nonpowered neurosurgical instrument is a hand instrument or an accessory to a hand in-

## 21 CFR Ch. I (4-1-20 Edition)

strument used during neurosurgical procedures to cut, hold, or manipulate tissue. It includes specialized chisels, osteotomes, curettes, dissectors, elevators, forceps, gouges, hooks, surgical knives, rasps, scissors, separators, spatulas, spoons, blades, blade holders, blade breakers, probes, etc.

(b) *Classification.* Class I (general controls). The device is exempt from the premarket notification procedures in subpart E of part 807 of this chapter subject to the limitations in § 882.9.

[44 FR 51730, Sept. 4, 1979, as amended at 59 FR 63012, Dec. 7, 1994; 66 FR 38808, July 25, 2001]

### § 882.4545 Shunt system implantation instrument.

(a) *Identification.* A shunt system implantation instrument is an instrument used in the implantation of cerebrospinal fluid shunts, and includes tunneling instruments for passing shunt components under the skin.

(b) *Classification.* Class I (general controls). The device is exempt from the premarket notification procedures in subpart E of part 807 of this chapter subject to the limitations in § 882.9.

[44 FR 51730, Sept. 4, 1979, as amended at 65 FR 2319, Jan. 14, 2000; 84 FR 71815, Dec. 30, 2019]

### § 882.4560 Stereotaxic instrument.

(a) *Identification.* A stereotaxic instrument is a device consisting of a rigid frame with a calibrated guide mechanism for precisely positioning probes or other devices within a patient's brain, spinal cord, or other part of the nervous system.

(b) *Classification.* Class II (performance standards).

### § 882.4600 Leukotome.

(a) *Identification.* A leukotome is a device used to cut sections out of the brain.

(b) *Classification.* Class I (general controls). The device is exempt from the premarket notification procedures in subpart E of part 807 of this chapter subject to the limitations in § 882.9.

[44 FR 51730, Sept. 4, 1979, as amended at 59 FR 63012, Dec. 7, 1994; 66 FR 38808, July 25, 2001]

**Food and Drug Administration, HHS**

**§ 882.5050**

**§ 882.4650 Neurosurgical suture needle.**

(a) *Identification.* A neurosurgical suture needle is a needle used in suturing during neurosurgical procedures or in the repair of nervous tissue.

(b) *Classification.* Class I (general controls). The device is exempt from the premarket notification procedures in subpart E of part 807 of this chapter subject to § 882.9.

[44 FR 51730, Sept. 4, 1979, as amended at 54 FR 25051, June 12, 1989; 65 FR 2319, Jan. 14, 2000]

**§ 882.4700 Neurosurgical paddie.**

(a) A neurosurgical paddie is a pad used during surgery to protect nervous tissue, absorb fluids, or stop bleeding.

(b) *Classification.* Class II (performance standards).

[44 FR 51730, Sept. 4, 1979, as amended at 69 FR 10332, Mar. 5, 2004]

**§ 882.4725 Radiofrequency lesion probe.**

(a) *Identification.* A radiofrequency lesion probe is a device connected to a radiofrequency (RF) lesion generator to deliver the RF energy to the site within the nervous system where a lesion is desired.

(b) *Classification.* Class II (performance standards).

**§ 882.4750 Skull punch.**

(a) *Identification.* A skull punch is a device used to punch holes through a patient's skull to allow fixation of cranioplasty plates or bone flaps by wire or other means.

(b) *Classification.* Class I (general controls). The device is exempt from the premarket notification procedures in subpart E of part 807 of this chapter subject to § 882.9. This exemption does not apply to powered compound cranial drills, burrs, trephines, and their accessories classified under § 882.4305.

[44 FR 51730, Sept. 4, 1979, as amended at 65 FR 2319, Jan. 14, 2000]

**§ 882.4800 Self-retaining retractor for neurosurgery.**

(a) *Identification.* A self-retaining retractor for neurosurgery is a self-locking device used to hold the edges of a wound open during neurosurgery.

(b) *Classification.* Class II (performance standards).

**§ 882.4840 Manual rongeur.**

(a) *Identification.* A manual rongeur is a manually operated instrument used for cutting or biting bone during surgery involving the skull or spinal column.

(b) *Classification.* Class II (performance standards).

**§ 882.4845 Powered rongeur.**

(a) *Identification.* A powered rongeur is a powered instrument used for cutting or biting bone during surgery involving the skull or spinal column.

(b) *Classification.* Class II (performance standards).

**§ 882.4900 Skullplate screwdriver.**

(a) *Identification.* A skullplate screwdriver is a tool used by the surgeon to fasten cranioplasty plates or skullplates to a patient's skull by screws.

(b) *Classification.* Class I (general controls). The device is exempt from the premarket notification procedures in subpart E of part 807 of this chapter subject to the limitations in § 882.9.

[44 FR 51730, Sept. 4, 1979, as amended at 59 FR 63012, Dec. 7, 1994; 66 FR 38808, July 25, 2001]

**Subpart F—Neurological Therapeutic Devices**

**§ 882.5030 Methyl methacrylate for aneurysmorrhaphy.**

(a) *Identification.* Methyl methacrylate for aneurysmorrhaphy (repair of aneurysms, which are balloonlike sacs formed on blood vessels) is a self-curing acrylic used to encase and reinforce intracranial aneurysms that are not amenable to conservative management, removal, or obliteration by aneurysm clip.

(b) *Classification.* Class II (performance standards).

**§ 882.5050 Biofeedback device.**

(a) *Identification.* A biofeedback device is an instrument that provides a visual or auditory signal corresponding to the status of one or more of a patient's physiological parameters (e.g.,

**§ 882.5070**

**21 CFR Ch. I (4–1–20 Edition)**

brain alpha wave activity, muscle activity, skin temperature, etc.) so that the patient can control voluntarily these physiological parameters.

(b) *Classification.* Class II (special controls). The device is exempt from the premarket notification procedures in subpart E of part 807 of this chapter when it is a prescription battery powered device that is indicated for relaxation training and muscle reeducation and prescription use, subject to § 882.9.

[44 FR 51730, Sept. 4, 1979, as amended at 63 FR 59229, Nov. 3, 1998]

**§ 882.5070 Bite block.**

(a) *Identification.* A bite block is a device inserted into a patient's mouth to protect the tongue and teeth while the patient is having convulsions.

(b) *Classification.* Class II (performance standards).

**§ 882.5150 Intravascular occluding catheter.**

(a) *Identification.* An intravascular occluding catheter is a catheter with an inflatable or detachable balloon tip that is used to block a blood vessel to treat malformations, e.g., aneurysms (balloonlike sacs formed on blood vessels) of intracranial blood vessels.

(b) *Classification.* Class III (premarket approval).

(c) *Date PMA or notice of completion of a PDP is required.* A PMA or a notice of completion of a PDP is required to be filed with the Food and Drug Administration on or before December 26, 1996 for any intravascular occluding catheter that was in commercial distribution before May 28, 1976, or that has, on or before December 26, 1996 been found to be substantially equivalent to an intravascular occluding catheter that was in commercial distribution before May 28, 1976. Any other intravascular occluding catheter shall have an approved PMA or a declared completed PDP in effect before being placed in commercial distribution.

[44 FR 51730, Sept. 4, 1979, as amended at 52 FR 17740, May 11, 1987; 61 FR 50708, Sept. 27, 1996]

**§ 882.5175 Carotid artery clamp.**

(a) *Identification.* A carotid artery clamp is a device that is surgically

placed around a patient's carotid artery (the principal artery in the neck that supplies blood to the brain) and has a removable adjusting mechanism that protrudes through the skin of the patient's neck. The clamp is used to occlude the patient's carotid artery to treat intracranial aneurysms (balloonlike sacs formed on blood vessels) or other intracranial vascular malformations that are difficult to attach directly by reducing the blood pressure and blood flow to the aneurysm or malformation.

(b) *Classification.* Class II (performance standards).

**§ 882.5200 Aneurysm clip.**

(a) *Identification.* An aneurysm clip is a device used to occlude an intracranial aneurysm (a balloonlike sac formed on a blood vessel) to prevent it from bleeding or bursting.

(b) *Classification.* Class II (performance standards).

**§ 882.5225 Implanted malleable clip.**

(a) *Identification.* An implanted malleable clip is a bent wire or staple that is forcibly closed with a special instrument to occlude an intracranial blood vessel or aneurysm (a balloonlike sac formed on a blood vessel), stop bleeding, or hold tissue or a mechanical device in place in a patient.

(b) *Classification.* Class II (performance standards).

**§ 882.5235 Aversive conditioning device.**

(a) *Identification.* An aversive conditioning device is an instrument used to administer an electrical shock or other noxious stimulus to a patient to modify undesirable behavioral characteristics.

(b) *Classification.* Class II (performance standards).

EFFECTIVE DATE NOTE: At 85 FR 13354, Mar. 6, 2020, § 882.5235 was revised, effective Apr. 6, 2020. For the convenience of the user, the revised text is set forth as follows:

**§ 882.5235 Aversive conditioning device.**

\* \* \* \* \*

(b) *Classification.* Class II (special controls), except for electrical stimulation devices for



## Food and Drug Administration, HHS

## § 882.5600

self-injurious or aggressive behavior. Electrical stimulation devices for self-injurious or aggressive behavior are banned. See § 895.105 of this chapter.

### § 882.5250 Burr hole cover.

(a) *Identification.* A burr hole cover is a plastic or metal device used to cover or plug holes drilled into the skull during surgery and to reattach cranial bone removed during surgery.

(b) *Classification.* Class II (performance standards).

### § 882.5275 Nerve cuff.

(a) *Identification.* A nerve cuff is a tubular silicone rubber sheath used to encase a nerve for aid in repairing the nerve (e.g., to prevent ingrowth of scar tissue) and for capping the end of the nerve to prevent the formation of neuroma (tumors).

(b) *Classification.* Class II (performance standards).

### § 882.5300 Methyl methacrylate for cranioplasty.

(a) *Identification.* Methyl methacrylate for cranioplasty (skull repair) is a self-curing acrylic that a surgeon uses to repair a skull defect in a patient. At the time of surgery, the surgeon initiates polymerization of the material and forms it into a plate or other appropriate shape to repair the defect.

(b) *Classification.* Class II (performance standards).

### § 882.5320 Preformed alterable cranioplasty plate.

(a) *Identification.* A preformed alterable cranioplasty plate is a device that is implanted into a patient to repair a skull defect. It is constructed of a material, e.g., tantalum, that can be altered or reshaped at the time of surgery without changing the chemical behavior of the material.

(b) *Classification.* Class II (performance standards).

### § 882.5330 Preformed nonalterable cranioplasty plate.

(a) *Identification.* A preformed nonalterable cranioplasty plate is a device that is implanted in a patient to repair a skull defect and is constructed of a material, e.g., stainless steel or vitallium, that cannot be altered or re-

shaped at the time of surgery without changing the chemical behavior of the material.

(b) *Classification.* Class II (performance standards).

### § 882.5360 Cranioplasty plate fastener.

(a) *Identification.* A cranioplasty plate fastener is a screw, wire, or other article made of tantalum, vitallium, or stainless steel used to secure a plate to the patient's skull to repair a skull defect.

(b) *Classification.* Class II (performance standards).

### § 882.5500 Lesion temperature monitor.

(a) *Identification.* A lesion temperature monitor is a device used to monitor the tissue temperature at the site where a lesion (tissue destruction) is to be made when a surgeon uses a radio-frequency (RF) lesion generator and probe.

(b) *Classification.* Class II (performance standards).

### § 882.5550 Central nervous system fluid shunt and components.

(a) *Identification.* A central nervous system fluid shunt is a device or combination of devices used to divert fluid from the brain or other part of the central nervous system to an internal delivery site or an external receptacle for the purpose of relieving elevated intracranial pressure or fluid volume (e.g., due to hydrocephalus). Components of a central nervous system shunt include catheters, valved catheters, valves, connectors, and other accessory components intended to facilitate use of the shunt or evaluation of a patient with a shunt.

(b) *Classification.* Class II (performance standards).

### § 882.5600 Neurovascular mechanical thrombectomy device for acute ischemic stroke treatment.

(a) *Identification.* A neurovascular mechanical thrombectomy device for acute ischemic stroke treatment is a prescription device used in the treatment of acute ischemic stroke to improve clinical outcomes. The device is delivered into the neurovasculature

§ 882.5700

21 CFR Ch. I (4–1–20 Edition)

with an endovascular approach, mechanically removes thrombus from the body, and restores blood flow in the neurovasculature.

(b) *Classification.* Class II (special controls). The special controls for this device are:

(1) The patient contacting components of the device must be demonstrated to be biocompatible.

(2) Non-clinical performance testing must demonstrate that the device performs as intended under anticipated conditions of use, including:

(i) Mechanical testing to demonstrate the device can withstand anticipated tensile, torsional, and compressive forces.

(ii) Mechanical testing to evaluate the radial forces exerted by the device.

(iii) Non-clinical testing to verify the dimensions of the device.

(iv) Non-clinical testing must demonstrate the device can be delivered to the target location in the neurovasculature and retrieve simulated thrombus under simulated use conditions.

(v) Non-clinical testing must demonstrate the device is radiopaque and can be visualized.

(vi) Non-clinical testing must evaluate the coating integrity and particulates under simulated use conditions.

(vii) Animal testing must evaluate the safety of the device, including damage to the vessels or tissue under anticipated use conditions.

(3) Performance data must support the sterility and pyrogenicity of the patient contacting components of the device.

(4) Performance data must support the shelf-life of the device by demonstrating continued sterility, package integrity, and device functionality over the specified shelf-life.

(5) Clinical performance testing of the device must demonstrate the device performs as intended for use in the treatment of acute ischemic stroke and must capture any adverse events associated with the device and procedure.

(6) The labeling must include:

(i) Information on the specific patient population for which the device is intended for use in the treatment of acute ischemic stroke, including but not limited to, specifying time from

symptom onset, vessels or location of the neurovasculature that can be accessed for treatment, and limitations on core infarct size.

(ii) Detailed instructions on proper device preparation and use for thrombus retrieval from the neurovasculature.

(iii) A summary of the clinical testing results, including a detailed summary of the device- and procedure-related complications and adverse events.

(iv) A shelf life.

[81 FR 94253, Dec. 23, 2016]

§ 882.5700 Thermal system for insomnia.

(a) *Identification.* A thermal system for insomnia is a prescription device for use in patients with insomnia that is used to apply a specified temperature to the skin surface.

(b) *Classification.* Class II (special controls). The special controls for this device are:

(1) The patient-contacting components of the device must be demonstrated to be biocompatible.

(2) Performance testing must demonstrate electromagnetic compatibility and electrical safety.

(3) Non-clinical performance testing must demonstrate that the device performs as intended under anticipated conditions of use. The following performance characteristics must be evaluated:

(i) Thermal performance of the device, including maintenance of the target temperature, must be evaluated under simulated use conditions.

(ii) Mechanical testing to demonstrate the device can withstand forces under anticipated use conditions.

(iii) Mechanical testing to demonstrate the device is resistant to leakage under anticipated use conditions.

(4) Software verification, validation, and hazard analysis must be performed.

(5) Patient labeling must be provided to convey information regarding safe use of the device, including instructions for assembly.

[81 FR 44772, July 11, 2016]

**§ 882.5800 Cranial electrotherapy stimulator.**

(a) *Identification.* A cranial electrotherapy stimulator is a prescription device that applies electrical current that is not intended to induce a seizure to a patient's head to treat psychiatric conditions.

(b) *Classification.* (1) Class II (special controls) when intended to treat insomnia and/or anxiety. The special controls for this device are:

(i) A detailed summary of the clinical testing pertinent to use of the device to demonstrate the effectiveness of the device to treat insomnia and/or anxiety.

(ii) Components of the device that come into human contact must be demonstrated to be biocompatible.

(iii) The device must be designed and tested for electrical safety and electromagnetic compatibility (EMC) in its intended use environment.

(iv) Appropriate software verification, validation, and hazard analysis must be performed.

(v) The technical parameters of the device, including waveform, output mode, pulse duration, frequency, train delivery, maximum charge, and energy, must be fully characterized and verified.

(vi) The labeling for the device must include the following:

(A) The intended use population and the intended use environment;

(B) A warning that patients should be monitored by their physician for signs of worsening;

(C) A warning that instructs patients on how to mitigate the risk of headaches, and what to do should a headache occur;

(D) A warning that instructs patients on how to mitigate the risk of dizziness, and what to do should dizziness occur;

(E) A detailed summary of the clinical testing, which includes the clinical outcomes associated with the use of the device, and a summary of adverse events and complications that occurred with the device;

(F) Instructions for use that address where to place the electrodes, what stimulation parameters to use, and duration and frequency of treatment sessions. This information must be based

on the results of clinical studies for the device;

(G) A detailed summary of the device technical parameters, including waveform, output mode, pulse duration, frequency, train delivery, and maximum charge and energy; and

(H) Information on validated methods for reprocessing any reusable components between uses.

(vii) Cranial electrotherapy stimulator devices marketed prior to the effective date of this reclassification must have an amendment submitted to the previously cleared premarket notification (510(k)) demonstrating compliance with these special controls.

(2) Class III (premarket approval) when intended to treat depression.

(c) Date premarket approval application (PMA) or notice of completion of product development protocol (PDP) is required. A PMA or notice of completion of a PDP is required to be filed with the Food and Drug Administration on or before March 19, 2020, for any cranial electrotherapy stimulator device with an intended use described in paragraph (b)(2) of this section, that was in commercial distribution before May 28, 1976, or that has, on or before March 19, 2020, been found to be substantially equivalent to any cranial electrotherapy stimulator device with an intended use described in paragraph (b)(2) of this section, that was in commercial distribution before May 28, 1976. Any other cranial electrotherapy stimulator device with an intended use described in paragraph (b)(2) of this section shall have an approved PMA or declared completed PDP in effect before being placed in commercial distribution.

[84 FR 70013, Dec. 20, 2019]

**§ 882.5801 Computerized behavioral therapy device for psychiatric disorders.**

(a) *Identification.* A computerized behavioral therapy device for psychiatric disorders is a prescription only device intended to provide a computerized version of condition-specific behavioral therapy as an adjunct to clinician supervised outpatient treatment to patients with psychiatric conditions. The digital therapy is intended to provide patients access to therapy tools used

**§ 882.5802**

during treatment sessions to improve recognized treatment outcomes.

(b) *Classification.* Class II (special controls). The special controls for this device are:

(1) Clinical data must be provided to fulfill the following:

(i) Describe a validated model of behavioral therapy for the psychiatric disorder; and

(ii) Validate the model of behavioral therapy as implemented by the device.

(2) Software must be described in detail in the software requirements specification (SRS) and software design specification (SDS). Software verification, validation, and hazard analysis must be performed. Software documentation must demonstrate that the device effectively implements the behavioral therapy model.

(3) The following labeling must be provided:

(i) Patient and physician labeling must include instructions for use, including images that demonstrate how to interact with the device.

(ii) Patient and physician labeling must list compatible devices.

(iii) Patient and physician labeling must include a warning that the device is not intended for use as a standalone therapy.

(iv) Patient and physician labeling must include a warning that the device does not represent a substitution for the patient's medication.

(v) Physician labeling must include a summary of the clinical testing with the device.

[82 FR 61167, Dec. 27, 2017]

**§ 882.5802 Transcranial magnetic stimulation system for neurological and psychiatric disorders and conditions.**

(a) *Identification.* A transcranial magnetic stimulation system for neurological and psychiatric disorders and conditions is a prescription, non-implantable device that uses brief duration, rapidly alternating, or pulsed, magnetic fields to induce neural activity in the cerebral cortex. It is not intended for applying or focusing magnetic fields towards brain areas outside cerebral cortex (e.g., cerebellum). A repetitive transcranial magnetic stimulation system that is intended to treat

**21 CFR Ch. I (4–1–20 Edition)**

major depressive disorder is classified in § 882.5805. A transcranial magnetic stimulation system for headache is classified in § 882.5808.

(b) *Classification.* Class II (special controls). The special controls for this device are:

(1) Performance testing must demonstrate electromagnetic compatibility, electrical safety, and thermal safety.

(2) Software verification, validation, and hazard analysis must be performed.

(3) The patient-contacting components of the device must be demonstrated to be biocompatible.

(4) Non-clinical performance testing must demonstrate that the device performs as intended under anticipated conditions of use. The following performance characteristics must be tested:

(i) Magnetic pulse output testing;

(ii) Magnetic and electrical field testing;

(iii) Testing of the safety features built into the device; and

(iv) Testing of the sound levels patients are exposed to during device use.

(5) The physician and patient labeling must include the following:

(i) The risks and benefits associated with use of the device;

(ii) Detailed instructions to prevent seizures, to monitor the patient for seizure activity during treatment, and to provide seizure management care if one were to occur during treatment; and

(iii) A description of the ear protection to be worn by the patient during use of the device, including the type of protection and its noise reduction rating.

[84 FR 9230, Mar. 14, 2019]

**§ 882.5805 Repetitive transcranial magnetic stimulation system.**

(a) *Identification.* A repetitive transcranial magnetic stimulation system is an external device that delivers transcranial repetitive pulsed magnetic fields of sufficient magnitude to induce neural action potentials in the prefrontal cortex to treat the symptoms of major depressive disorder without inducing seizure in patients who have failed at least one antidepressant medication and are currently not on any antidepressant therapy.

(b) *Classification.* Class II (special controls). The special control is FDA's "Class II Special Controls Guidance Document: Repetitive Transcranial Magnetic Stimulation System." See § 882.1(e) for the availability of this guidance document.

[76 FR 44491, July 26, 2011]

**§ 882.5808 Transcranial magnetic stimulator for headache.**

(a) *Identification.* A transcranial magnetic stimulator device for headache is a device that delivers brief duration, rapidly alternating, or pulsed, magnetic fields that are externally directed at spatially discrete regions of the brain to induce electrical currents for the treatment of headache.

(b) *Classification.* Class II (special controls). The special controls for this device are:

(1) Appropriate analysis/testing must demonstrate electromagnetic compatibility, electrical safety, and thermal safety.

(2) Appropriate verification, validation, and hazard analysis must be performed on the device software and firmware.

(3) The elements of the device that contact the patient must be assessed to be biocompatible.

(4) Non-clinical testing data must demonstrate that the device performs as intended under anticipated conditions of use. This includes full characterization of the magnetic pulse output and resulting magnetic field map. This also includes characterization of the sound level of the device during use.

(5) Clinical testing must demonstrate that the device is safe and effective for treating headache in the indicated patient population.

(6) The physician and patient labeling must include the following:

(i) A summary of the clinical performance testing, including any adverse events and complications.

(ii) The intended use population in terms of the types of headaches appropriate for use with the device.

(iii) Information on how to report adverse events and device malfunctions.

(iv) A diagram or picture depicting the proper placement of the device on the user.

[78 FR 38458, July 8, 2014]

**§ 882.5810 External functional neuromuscular stimulator.**

(a) *Identification.* An external functional neuromuscular stimulator is an electrical stimulator that uses external electrodes for stimulating muscles in the leg and ankle of partially paralyzed patients (e.g., after stroke) to provide flexion of the foot and thus improve the patient's gait.

(b) *Classification.* Class II (performance standards).

**§ 882.5820 Implanted cerebellar stimulator.**

(a) *Identification.* An implanted cerebellar stimulator is a device used to stimulate electrically a patient's cerebellar cortex for the treatment of intractable epilepsy, spasticity, and some movement disorders. The stimulator consists of an implanted receiver with electrodes that are placed on the patient's cerebellum and an external transmitter for transmitting the stimulating pulses across the patient's skin to the implanted receiver.

(b) *Classification.* Class III (premarket approval).

(c) *Date premarket approval application (PMA) or notice of completion of a product development protocol (PDP) is required.* A PMA or notice of completion of a PDP is required to be filed with the Food and Drug Administration on or before September 26, 1984. Any implanted cerebellar stimulator that was not in commercial distribution before May 28, 1976, or that has not on or before September 26, 1984 been found by FDA to be substantially equivalent to an implanted cerebellar stimulator that was in commercial distribution before May 28, 1976 shall have an approved PMA or declared completed PDP in effect before beginning commercial distribution.

[44 FR 51730, Sept. 4, 1979, as amended at 49 FR 26574, June 28, 1984]

**§ 882.5830 Implanted diaphragmatic/phrenic nerve stimulator.**

(a) *Identification.* An implanted diaphragmatic/phrenic nerve stimulator is a device that provides electrical stimulation of a patient's phrenic nerve to contract the diaphragm rhythmically and produce breathing in patients who have hypoventilation (a state in which an abnormally low amount of air enters the lungs) caused by brain stem disease, high cervical spinal cord injury, or chronic lung disease. The stimulator consists of an implanted receiver with electrodes that are placed around the patient's phrenic nerve and an external transmitter for transmitting the stimulating pulses across the patient's skin to the implanted receiver.

(b) *Classification.* Class III (premarket approval).

(c) *Date premarket approval application (PMA) or notice of completion of a product development protocol (PDP) is required.* A PMA or a notice of completion of a PDP is required to be filed with the Food and Drug Administration on or before July 7, 1986 for any implanted diaphragmatic/phrenic nerve stimulator that was in commercial distribution before May 28, 1976, or that has on or before July 7, 1986 been found to be substantially equivalent to an implanted diaphragmatic/phrenic nerve stimulator that was in commercial distribution before May 28, 1976. Any other implanted diaphragmatic/phrenic nerve stimulator shall have an approved PMA or a declared completed PDP in effect before being placed in commercial distribution.

[44 FR 51730, Sept. 4, 1979, as amended at 51 FR 12101, Apr. 8, 1986]

**§ 882.5840 Implanted intracerebral/subcortical stimulator for pain relief.**

(a) *Identification.* An implanted intracerebral/subcortical stimulator for pain relief is a device that applies electrical current to subsurface areas of a patient's brain to treat severe intractable pain. The stimulator consists of an implanted receiver with electrodes that are placed within a patient's brain and an external transmitter for transmitting the stimu-

lating pulses across the patient's skin to the implanted receiver.

(b) *Classification.* Class III (premarket approval).

(c) *Date premarket approval application (PMA) or notice of completion of a product development protocol (PDP) is required.* A PMA or a notice of completion of a PDP is required to be filed with the Food and Drug Administration on or before March 1, 1989, for any implanted intracerebral/subcortical stimulator for pain relief that was in commercial distribution before May 28, 1976, or that has on or before March 1, 1989, been found to be substantially equivalent to an implanted intracerebral/subcortical stimulator for pain relief that was in commercial distribution before May 28, 1976. Any other implanted intracerebral/subcortical stimulator for pain relief shall have an approved PMA or a declared completed PDP in effect before being placed in commercial distribution.

[44 FR 51730, Sept. 4, 1979, as amended at 53 FR 48621, Dec. 1, 1988]

**§ 882.5850 Implanted spinal cord stimulator for bladder evacuation.**

(a) *Identification.* An implanted spinal cord stimulator for bladder evacuation is an electrical stimulator used to empty the bladder of a paraplegic patient who has a complete transection of the spinal cord and who is unable to empty his or her bladder by reflex means or by the intermittent use of catheters. The stimulator consists of an implanted receiver with electrodes that are placed on the conus medullaris portion of the patient's spinal cord and an external transmitter for transmitting the stimulating pulses across the patient's skin to the implanted receiver.

(b) *Classification.* Class III (premarket approval).

(c) *Date PMA or notice of completion of a PDP is required.* A PMA or a notice of completion of a PDP is required to be filed with the Food and Drug Administration on or before December 26, 1996 for any implanted spinal cord stimulator for bladder evacuation that was in commercial distribution before May 28, 1976, or that has, on or before December 26, 1996 been found to be substantially equivalent to an implanted

spinal cord stimulator for bladder evacuation that was in commercial distribution before May 28, 1976. Any other implanted spinal cord stimulator for bladder evacuation shall have an approved PMA or a declared completed PDP in effect before being placed in commercial distribution.

[44 FR 51730, Sept. 4, 1979, as amended at 52 FR 17740, May 11, 1987; 61 FR 50708, Sept. 27, 1996]

**§ 882.5860 Implanted neuromuscular stimulator.**

(a) *Identification.* An implanted neuromuscular stimulator is a device that provides electrical stimulation to a patient's peroneal or femoral nerve to cause muscles in the leg to contract, thus improving the gait in a patient with a paralyzed leg. The stimulator consists of an implanted receiver with electrodes that are placed around a patient's nerve and an external transmitter for transmitting the stimulating pulses across the patient's skin to the implanted receiver. The external transmitter is activated by a switch in the heel in the patient's shoe.

(b) *Classification.* Class III (premarket approval).

(c) *Date PMA or notice of completion of PDP is required.* A PMA or notice of completion of a PDP for a device described in paragraph (b) of this section is required to be filed with the Food and Drug Administration on or before July 13, 1999 for any implanted neuromuscular stimulator that was in commercial distribution before May 28, 1976, or that has, on or before July 13, 1999, been found to be substantially equivalent to an implanted neuromuscular stimulator that was in commercial distribution before May 28, 1976. Any other implanted neuromuscular stimulator shall have an approved PMA or declared completed PDP in effect before being placed in commercial distribution.

[44 FR 51730, Sept. 4, 1979, as amended at 52 FR 17740, May 11, 1987; 64 FR 18329, Apr. 14, 1999]

**§ 882.5870 Implanted peripheral nerve stimulator for pain relief.**

(a) *Identification.* An implanted peripheral nerve stimulator for pain relief is a device that is used to stimulate

electrically a peripheral nerve in a patient to relieve severe intractable pain. The stimulator consists of an implanted receiver with electrodes that are placed around a peripheral nerve and an external transmitter for transmitting the stimulating pulses across the patient's skin to the implanted receiver.

(b) *Classification.* Class II (performance standards).

[44 FR 51730, Sept. 4, 1979, as amended at 78 FR 18234, Mar. 26, 2013]

**§ 882.5880 Implanted spinal cord stimulator for pain relief.**

(a) *Identification.* An implanted spinal cord stimulator for pain relief is a device that is used to stimulate electrically a patient's spinal cord to relieve severe intractable pain. The stimulator consists of an implanted receiver with electrodes that are placed on the patient's spinal cord and an external transmitter for transmitting the stimulating pulses across the patient's skin to the implanted receiver.

(b) *Classification.* Class II (performance standards).

**§ 882.5890 Transcutaneous electrical nerve stimulator for pain relief.**

(a) *Identification.* A transcutaneous electrical nerve stimulator for pain relief is a device used to apply an electrical current to electrodes on a patient's skin to treat pain.

(b) *Classification.* Class II (performance standards).

**§ 882.5891 Transcutaneous electrical nerve stimulator to treat headache.**

(a) *Identification.* A transcutaneous electrical nerve stimulator to treat headache is a device used to apply an electrical current to a patient's cranium through electrodes placed on the skin.

(b) *Classification.* Class II (special controls). The special controls for this device are:

(1) The patient-contacting components of the device must be demonstrated to be biocompatible.

(2) Appropriate analysis/testing must validate electromagnetic compatibility and electrical, mechanical, and thermal safety.

(3) The technical parameters of the device, including waveform, output modes, maximum output voltage and current (with 500, 2,000, and 10,000 ohm loads), pulse duration, frequency, net charge ( $\mu\text{C}$ ) per pulse, maximum phase charge at 500 ohms, maximum current density ( $\text{mA}/\text{cm}^2$ , r.m.s.), maximum average current (mA), maximum average power density ( $\text{W}/\text{cm}^2$ ), and the type of impedance monitoring system must be fully characterized.

(4) Electrical performance, adhesive integrity, shelf life, reusability, and current distribution testing of the electrodes must be conducted.

(5) Appropriate software verification, validation, and hazard analysis must be performed.

(6) Clinical performance data must demonstrate that the device is safe and effective as a treatment for headache in the indicated patient population.

(7) Labeling must include the following:

(i) Appropriate contraindications such as not for use in subjects with an implanted metallic or electronic device in the head, a cardiac pacemaker, or an implanted or wearable defibrillator.

(ii) Appropriate warnings such as not to apply the device on the neck or chest, not to use the device in the presence of electronic monitoring equipment, not to use in the bath or shower, not to use while sleeping, not to use while driving, not to use while operating machinery.

(iii) Appropriate precautions such as the long-term effects of chronic use of the device are unknown.

(iv) A summary of the expected risks and benefits of using the device.

(v) A summary of the clinical performance data, including information on the patient population for which the device has and has not been demonstrated to be effective, and any adverse events and complications.

(vi) Information on how the device operates and the typical sensations experienced during treatment.

(vii) A detailed summary of the device technical parameters.

(viii) An expiration date/shelf life for the electrodes and the number of times they can be reused.

(ix) Disposal instructions.

[79 FR 37948, July 3, 2014]

#### § 882.5892 External vagal nerve stimulator for headache.

(a) *Identification.* An external vagal nerve stimulator for headache is a prescription device used to apply an electrical current to a patient's vagus nerve through electrodes placed on the skin for the treatment of headache.

(b) *Classification.* Class II (special controls). The special controls for this device are:

(1) The technical parameters of the device, including waveform, output modes, maximum output voltage and current (with 500, 2,000, and 10,000 ohm loads), pulse duration, frequency, net charge ( $\mu\text{C}$ ) per pulse, maximum phase charge at 500 ohms, maximum current density ( $\text{mA}/\text{cm}^2$ , r.m.s.), maximum average current (mA), maximum average power density ( $\text{W}/\text{cm}^2$ ), and the type of impedance monitoring system shall be fully characterized through non-clinical performance testing.

(2) Software verification, validation, and hazard analysis shall be performed.

(3) Biocompatibility evaluation of the patient-contacting components of the device shall be performed.

(4) The device shall be tested for electrical, thermal, and mechanical safety, and for electromagnetic compatibility (EMC).

(5) The labeling must include:

(i) Instructions for proper use of the device, including placement of the device on the patient; and

(ii) Instructions on care and cleaning of the device.

[82 FR 61169, Dec. 27, 2017]

#### § 882.5893 Thermal vestibular stimulator for headache.

(a) *Identification.* The thermal vestibular stimulator for headache is a prescription device used to stimulate the vestibular system by applying thermal waveforms through earpieces placed in a patient's ear canal for the treatment of headache.

(b) *Classification.* Class II (special controls). The special controls for this device are:

(1) The patient-contacting components of the device must be demonstrated to be biocompatible.

(2) Performance testing must validate electromagnetic compatibility



and electrical, mechanical, and thermal safety.

(3) The technical parameters of the device, including waveform outputs and temperature limits, must be identified.

(4) Cleaning validation of earpieces must be conducted.

(5) Software verification, validation, and hazard analysis must be performed.

(6) Labeling must include the following:

(i) Information on how the device operates and the typical sensations experienced during treatment;

(ii) A detailed summary of the device's technical parameters; and

(iii) Instructions for maintenance and cleaning of the device.

[83 FR 52973, Oct. 19, 2018]

**§ 882.5894 Limited output transcutaneous piezoelectric stimulator for skin reactions associated with insect bites.**

(a) *Identification.* A limited output transcutaneous piezoelectric stimulator for skin reactions associated with insect bites is a device intended to alleviate skin reactions associated with insect bites via cutaneous, piezoelectric stimulation at the local site of the bite.

(b) *Classification.* Class II (special controls). The special controls for this device are:

(1) Appropriate testing to characterize the electrical output specifications of the device (*i.e.*, total charge delivered, maximum instantaneous output current, maximum instantaneous output voltage, pulse duration, charge density) must be conducted.

(2) Mechanical bench testing must demonstrate that the device will withstand the labeled number duration of uses.

(3) All elements of the device that may contact the patient must be assessed to be biocompatible.

(4) Labeling must include:

(i) Validated instructions which addresses the following:

(A) Identification of areas of the body which are appropriate and not appropriate for contact with the device.

(B) Whether use of the device in conjunction with flammable materials (*e.g.*, insect repellent) is appropriate.

(C) Use of the device on or near implanted devices.

(D) How to identify the correct type of skin condition.

(ii) Technical parameters of the device (maximum output voltage (instantaneous), maximum output current (instantaneous), and pulse duration).

(iii) Language to direct end users to contact the device manufacturer and MedWatch if they experience any adverse events with this device.

(iv) The anticipated number of device uses prior to failure.

[80 FR 15165, Mar. 23, 2015]

**§ 882.5895 Vibratory counter-stimulation device.**

(a) *Identification.* A vibratory counter-stimulation device is a prescription device that provides electrically powered mechanical vibration to improve the quality of sleep in patients with primary Restless Legs Syndrome.

(b) *Classification.* Class II (special controls). The device is exempt from the premarket notification procedures in subpart E of part 807 of this chapter subject to the limitations in § 882.9. The special controls for this device are:

(1) Appropriate analysis/testing must demonstrate electromagnetic compatibility (EMC), electrical safety, and thermal safety.

(2) If the device contains software or firmware, appropriate verification, validation, and hazard analysis must be performed.

(3) The elements of the device that contact the patient must be assessed to be biocompatible.

(4) Non-clinical testing data (including vibration frequency, amplitude, and acceleration) must demonstrate that the device performs as intended under anticipated conditions of use.

(5) Labeling must include:

(i) Specific information pertinent to use of the device by the intended patient population and the treatment regimen;

(ii) Warning to only use the device on normal, intact, clean, healthy skin;

(iii) Warning to not use the device if the user has leg skin disorders, such as eczema, psoriasis, cellulitis, non-healing wounds;

**§ 882.5896**

(iv) Warning to discontinue use if Restless Leg Syndrome symptoms worsen; and

(v) Instructions for end users to contact the device manufacturer and MedWatch in case they experience any adverse events when using this device.

[82 FR 13554, Mar. 14, 2017, as amended at 84 FR 71815, Dec. 30, 2019]

**§ 882.5896 Percutaneous nerve stimulator for substance use disorders.**

(a) *Identification.* A percutaneous nerve stimulator for substance use disorders is a device that stimulates nerves percutaneously to aid in the reduction of withdrawal symptoms associated with substance use disorders.

(b) *Classification.* Class II (special controls). The special controls for this device are:

(1) The patient-contacting components of the device must be demonstrated to be biocompatible.

(2) Electromagnetic compatibility and electrical, mechanical, and thermal safety testing must be performed.

(3) Electrical performance testing of the device and electrodes must be conducted to validate the specified electrical output and duration of stimulation of the device.

(4) Software verification, validation, and hazard analysis must be performed.

(5) Sterility testing of the percutaneous components of the device must be performed.

(6) Shelf life testing must be performed to demonstrate continued sterility, package integrity, and device functionality over the specified shelf life.

(7) Labeling must include the following:

(i) A detailed summary of the device technical parameters;

(ii) A warning stating that the device is only for use on clean, intact skin;

(iii) Instructions for use, including placement of the device on the patient; and

(iv) A shelf life.

[83 FR 5034, Feb. 5, 2018]

**§ 882.5900 Preformed craniosynostosis strip.**

(a) *Identification.* A preformed craniosynostosis strip is a plastic strip used to cover bone edges of craniec-

**21 CFR Ch. I (4–1–20 Edition)**

tomy sites (sites where the skull has been cut) to prevent the bone from regrowing in patients whose skull sutures are abnormally fused together.

(b) *Classification.* Class II (performance standards).

**§ 882.5897 External upper limb tremor stimulator.**

(a) *Identification.* An external upper limb tremor stimulator is a prescription device which is placed externally on the upper limb and designed to aid in tremor symptom relief of the upper limb.

(b) *Classification.* Class II (special controls). The special controls for this device are:

(1) Non-clinical performance testing must assess the following:

(i) Characterization of the electrical stimulation, including the following, must be performed: Waveforms, output modes, maximum output voltage, maximum output current, pulse duration, frequency, net charge per pulse, maximum phase charge at 500 ohms, maximum current density, maximum average current, and maximum average power density.

(ii) Impedance testing, current distribution across the electrode surface area, adhesive integrity, and shelf life testing of the electrodes and gels must be conducted.

(iii) Simulated use testing of sensor performance and the associated algorithms that determine the stimulation output must be conducted.

(2) Patient-contacting components of the device must be demonstrated to be biocompatible.

(3) Performance testing must demonstrate electrical, thermal, and mechanical safety along with electromagnetic compatibility (EMC) of the device in the intended use environment.

(4) Software verification, validation, and hazard analysis must be performed.

(5) Physician and patient labeling must include:

(i) Summaries of electrical stimulation parameters;

(ii) Instructions on how to correctly use and maintain the device;

(iii) Instructions and explanations of all user-interface components;

(iv) Instructions on how to clean the device;

(v) A shelf life for the electrodes and gel; and

(vi) Reuse information.

[83 FR 52316, Oct. 17, 2018]

**§ 882.5910 Dura substitute.**

(a) *Identification.* A dura substitute is a sheet or material that is used to repair the dura mater (the membrane surrounding the brain).

(b) *Classification.* Class II (performance standards).

**§ 882.5940 Electroconvulsive therapy device.**

(a) *Identification.* An electroconvulsive therapy device is a prescription device, including the pulse generator and its stimulation electrodes, used for treating severe psychiatric disturbances by inducing in the patient a major motor seizure by applying a brief intense electrical current to the patient's head.

(b) *Classification.* (1) Class II (special controls) when the device is intended to treat catatonia or a severe major depressive episode (MDE) associated with major depressive disorder (MDD) or bipolar disorder (BPD) in patients age 13 years and older who are treatment-resistant or who require a rapid response due to the severity of their psychiatric or medical condition. The special controls for this device are:

(i) The technical parameters of the device, including waveform, output mode, pulse duration, frequency, train delivery, maximum charge and energy, and the type of impedance monitoring system must be fully characterized to ensure that the device performance characteristics are consistent with existing clinical performance data.

(ii) Non-clinical testing data must confirm the electrical characteristics of the output waveform.

(iii) Components of the device that come into human contact must be demonstrated to be biocompatible.

(iv) Performance data must demonstrate electrical and mechanical safety and the functioning of all safety features built into the device including the static and dynamic impedance monitoring system.

(v) Appropriate analysis/testing must validate electromagnetic compatibility.

(vi) Appropriate software verification, validation, and hazard analysis must be performed.

(vii) Performance data must demonstrate electrical performance, adhesive integrity, and physical and chemical stability of the stimulation electrodes.

(viii) The labeling for the device must include the following:

(A) Information related to generic adverse events associated with electroconvulsive therapy device (ECT) treatment;

(B) Instructions must contain the following specific recommendations to the user of the device:

(1) Conduct of pre-ECT medical and psychiatric assessment (including pertinent medical and psychiatric history, physical examination, anesthesia assessment, dental assessment, and other studies as clinically appropriate);

(2) Use of patient monitoring during the procedure;

(3) Use of general anesthesia and neuromuscular blocking agents;

(4) Use of mouth/dental protection during the procedure;

(5) Use of EEG monitoring until seizure termination;

(6) Instructions on electrode placement, including adequate skin preparation and use of conductive gel; and

(7) Cognitive status monitoring prior to beginning ECT and during the course of treatment via formal neuropsychological assessment for evaluating specific cognitive functions (*e.g.*, orientation, attention, memory, executive function).

(C) Clinical training needed by users of the device;

(D) Information on the patient population in which the device is intended to be used;

(E) Information on how the device operates and the typical course of treatment;

(F) A detailed summary of the clinical testing, which includes the clinical outcomes associated with the use of the device, and a summary of adverse events and complications that occurred with the device;

(G) A detailed summary of the device technical parameters;

(H) Where appropriate, validated methods and instructions for reprocessing of any reusable components;

(I) The following statement, prominently placed: “Warning: ECT device use may be associated with: disorientation, confusion, and memory problems”; and

(J) Absent performance data demonstrating a beneficial effect of longer term use, generally considered treatment in excess of 3 months, the following statement, prominently placed: “Warning: When used as intended this device provides short-term relief of symptoms. The long-term safety and effectiveness of ECT treatment has not been demonstrated.”

(ix) Patient labeling must be provided and include:

(A) Relevant contraindications, warnings, precautions;

(B) A summation of the clinical testing, which includes the clinical outcomes associated with the use of the device, and a summary of adverse events and complications that occurred with the device;

(C) Information on how the device operates and the typical course of treatment;

(D) The potential benefits;

(E) Alternative treatments;

(F) The following statement, prominently placed: “Warning: ECT device use may be associated with: Disorientation, confusion, and memory problems”;

(G) Absent performance data demonstrating a beneficial effect of longer term use, generally considered treatment in excess of 3 months, the following statement, prominently placed: “Warning: When used as intended this device provides short-term relief of symptoms. The long-term safety and effectiveness of ECT treatment has not been demonstrated”; and

(H) The following statements on known risks of ECT, absent performance data demonstrating that these risks do not apply:

(1) ECT treatment may be associated with disorientation, confusion and memory loss, including short-term (anterograde) and long-term (autobiographical) memory loss following

treatment. Based on the majority of clinical evidence, these side effects tend to go away within a few days to a few months after the last treatment with ECT. Although the incidence of permanent cognitive memory loss was not supported by the clinical literature, some patients have reported a permanent loss of memories of personal life events (*i.e.*, autobiographical memory);

(2) Patients treated with ECT may experience manic symptoms (including euphoria and/or irritability, impulsivity, racing thoughts, distractibility, grandiosity, increased activity, talkativeness, and decreased need for sleep) or a worsening of the psychiatric symptoms they are being treated for; and

(3) The physical risks of ECT may include the following (in order of frequency of occurrence):

(i) Pain/somatic discomfort (including headache, muscle soreness, and nausea);

(ii) Skin burns;

(iii) Physical trauma (including fractures, contusions, injury from falls, dental and oral injury);

(iv) Prolonged or delayed onset seizures;

(v) Pulmonary complications (hypoxemia, hypoventilation, aspiration, upper-airway obstruction);

(vi) Cardiovascular complications (cardiac arrhythmias, heart attack, high or low blood pressure, and stroke); and

(vii) Death.

(2) *Classification*: Class III (premarket approval) for the following intended uses: schizophrenia, bipolar manic states, schizoaffective disorder, schizophreniform disorder, and catatonia or a severe MDE associated with MDD or BPD in:

(i) Patients under 13 years or

(ii) Patients 13 years and older who are not treatment-resistant or who do not require a rapid response due to the severity of their psychiatric or medical condition.

(c) *Date premarket approval application (PMA) or notice of completion of product development protocol (PDP) is required*. A PMA or notice of completion of a PDP is required to be filed with FDA on or before March 26, 2019, for any

electroconvulsive therapy device with an intended use described in paragraph (b)(2) of this section, that was in commercial distribution before May 28, 1976, or that has, on or before March 26, 2019, been found to be substantially equivalent to any electroconvulsive therapy device with an intended use described in paragraph (b)(2) of this section, that was in commercial distribution before May 28, 1976. Any other electroconvulsive therapy device with an intended use described in paragraph (b)(2) of this section shall have an approved PMA or declared completed PDP in effect before being placed in commercial distribution.

[83 FR 66123, Dec. 26, 2018]

**§ 882.5950 Neurovascular embolization device.**

(a) *Identification.* A neurovascular embolization device is an intravascular implant intended to permanently occlude blood flow to cerebral aneurysms and cerebral arteriovenous malformations. This does not include cyanoacrylates and other embolic agents, which act by polymerization or precipitation. Embolization devices used in other vascular applications are also not included in this classification, see § 870.3300.

(b) *Classification.* Class II (special controls.) The special control for this device is the FDA guidance document entitled “Class II Special Controls Guidance Document: Vascular and Neurovascular Embolization Devices.” For availability of this guidance document, see § 882.1(e).

[69 FR 77900, Dec. 29, 2004]

**§ 882.5960 Skull tongs for traction.**

(a) *Identification.* Skull tongs for traction is an instrument used to immobilize a patient with a cervical spine injury (e.g., fracture or dislocation). The device is caliper shaped with tips that penetrate the skin. It is anchored to the skull and has a heavy weight attached to it that maintains, by traction, the patient’s position.

(b) *Classification.* Class II (performance standards).

**§ 882.5970 Cranial orthosis.**

(a) *Identification.* A cranial orthosis is a device that is intended for medical purposes to apply pressure to prominent regions of an infant’s cranium in order to improve cranial symmetry and/or shape in infants from 3 to 18 months of age, with moderate to severe nonsynostotic positional plagiocephaly, including infants with plagiocephalic-, brachycephalic-, and scaphocephalic-shaped heads.

(b) *Classification.* Class II (special controls) (prescription use in accordance with § 801.109 of this chapter, biocompatibility testing, and labeling (contraindications, warnings, precautions, adverse events, instructions for physicians and parents)).

[63 FR 40651, July 30, 1998]

**§ 882.5975 Human dura mater.**

(a) *Identification.* Human dura mater is human pachymeninx tissue intended to repair defects in human dura mater.

(b) *Classification.* Class II (special controls). The special control for this device is the FDA guidance document entitled “Class II Special Controls Guidance Document: Human Dura Mater.” See § 882.1(e) for the availability of this guidance.

(c) *Scope.* The classification set forth in this section is only applicable to human dura mater recovered prior to May 25, 2005.

[68 FR 70436, Dec. 18, 2003, as amended at 76 FR 36993, June 24, 2011]

**PART 884—OBSTETRICAL AND GYNECOLOGICAL DEVICES**

**Subpart A—General Provisions**

Sec.

884.1 Scope.

884.3 Effective dates of requirement for pre-market approval.

884.9 Limitations of exemptions from section 510(k) of the Federal Food, Drug, and Cosmetic Act (the act).

**Subpart B—Obstetrical and Gynecological Diagnostic Devices**

884.1040 Viscometer for cervical mucus.

884.1050 Endocervical aspirator.

884.1060 Endometrial aspirator.

884.1100 Endometrial brush.

**Pt. 884**

**21 CFR Ch. I (4–1–20 Edition)**

- 884.1175 Endometrial suction curette and accessories.
- 884.1185 Endometrial washer.
- 884.1300 Uterotubal carbon dioxide insufflator and accessories.
- 884.1425 Perineometer.
- 884.1550 Amniotic fluid sampler (amniocentesis tray).
- 884.1560 Fetal blood sampler.
- 884.1600 Transabdominal amnioscope (fetoscope) and accessories.
- 884.1630 Colposcope.
- 884.1640 Culdoscope and accessories.
- 884.1660 Transcervical endoscope (amnioscope) and accessories.
- 884.1690 Hysteroscope and accessories.
- 884.1700 Hysteroscopic insufflator.
- 884.1710 Closed loop hysteroscopic insufflator with cutter-coagulator.
- 884.1720 Gynecologic laparoscope and accessories.
- 884.1730 Laparoscopic insufflator.

**Subpart C—Obstetrical and Gynecological Monitoring Devices**

- 884.2050 Obstetric data analyzer.
- 884.2225 Obstetric-gynecologic ultrasonic imager.
- 884.2600 Fetal cardiac monitor.
- 884.2620 Fetal electroencephalographic monitor.
- 884.2640 Fetal phonocardiographic monitor and accessories.
- 884.2660 Fetal ultrasonic monitor and accessories.
- 884.2675 Fetal scalp circular (spiral) electrode and applicator.
- 884.2685 Fetal scalp clip electrode and applicator.
- 884.2700 Intrauterine pressure monitor and accessories.
- 884.2720 External uterine contraction monitor and accessories.
- 884.2730 Home uterine activity monitor.
- 884.2740 Perinatal monitoring system and accessories.
- 884.2800 Computerized labor monitoring system.
- 884.2900 Fetal stethoscope.
- 884.2960 Obstetric ultrasonic transducer and accessories.
- 884.2980 Telethermographic system.
- 884.2982 Liquid crystal thermographic system.
- 884.2990 Breast lesion documentation system.

**Subpart D—Obstetrical and Gynecological Prosthetic Devices**

- 884.3200 Cervical drain.
- 884.3575 Vaginal pessary.
- 884.3650 Fallopian tube prosthesis.
- 884.3900 Vaginal stent.

**Subpart E—Obstetrical and Gynecological Surgical Devices**

- 884.4050 Gynecologic laparoscopic power morcellation containment system.
- 884.4100 Endoscopic electrocautery and accessories.
- 884.4120 Gynecologic electrocautery and accessories.
- 884.4150 Bipolar endoscopic coagulator-cutter and accessories.
- 884.4160 Unipolar endoscopic coagulator-cutter and accessories.
- 884.4250 Expandable cervical dilator.
- 884.4260 Hygroscopic Laminaria cervical dilator.
- 884.4270 Vibratory cervical dilators.
- 884.4340 Fetal vacuum extractor.
- 884.4350 Fetal head elevator.
- 884.4400 Obstetric forceps.
- 884.4500 Obstetric fetal destructive instrument.
- 884.4520 Obstetric-gynecologic general manual instrument.
- 884.4530 Obstetric-gynecologic specialized manual instrument.
- 884.4550 Gynecologic surgical laser.
- 884.4900 Obstetric table and accessories.
- 884.4910 Specialized surgical instrumentation for use with urogynecologic surgical mesh.

**Subpart F—Obstetrical and Gynecological Therapeutic Devices**

- 884.5050 Metreurynter-balloon abortion system.
- 884.5070 Vacuum abortion system.
- 884.5100 Obstetric anesthesia set.
- 884.5150 Nonpowered breast pump.
- 884.5160 Powered breast pump.
- 884.5200 Hemorrhoid prevention pressure wedge.
- 884.5210 Pressure wedge for the reduction of cesarean delivery.
- 884.5225 Abdominal decompression chamber.
- 884.5250 Cervical cap.
- 884.5300 Condom.
- 884.5310 Condom with spermicidal lubricant.
- 884.5320 Glans sheath.
- 884.5330 Multiple-use female condom.
- 884.5340 Single-use internal condom.
- 884.5350 Contraceptive diaphragm and accessories.
- 884.5360 Contraceptive intrauterine device (IUD) and introducer.
- 884.5370 Software application for contraception.
- 884.5380 Contraceptive tubal occlusion device (TOD) and introducer.
- 884.5390 Perineal heater.
- 884.5400 Menstrual cup.
- 884.5425 Scented or scented deodorized menstrual pad.
- 884.5435 Unscented menstrual pad.
- 884.5460 Scented or scented deodorized menstrual tampon.

## Food and Drug Administration, HHS

## § 884.3

- 884.5470 Unscented menstrual tampon.
- 884.5900 Therapeutic vaginal douche apparatus.
- 884.5920 Vaginal insufflator.
- 884.5940 Powered vaginal muscle stimulator for therapeutic use.
- 884.5960 Genital vibrator for therapeutic use.
- 884.5970 Clitoral engorgement device.
- 884.5980 Surgical mesh for transvaginal pelvic organ prolapse repair.

### Subpart G—Assisted Reproduction Devices

- 884.6100 Assisted reproduction needles.
- 884.6110 Assisted reproduction catheters.
- 884.6120 Assisted reproduction accessories.
- 884.6130 Assisted reproduction microtools.
- 884.6140 Assisted reproduction micropipette fabrication instruments.
- 884.6150 Assisted reproduction micro-manipulators and microinjectors.
- 884.6160 Assisted reproduction labware.
- 884.6165 Intravaginal culture system.
- 884.6170 Assisted reproduction water and water purification systems.
- 884.6180 Reproductive media and supplements.
- 884.6190 Assisted reproductive microscopes and microscope accessories.
- 884.6195 Assisted reproduction embryo image assessment system.
- 884.6200 Assisted reproduction laser system.

AUTHORITY: 21 U.S.C. 351, 360, 360c, 360e, 360j, 360l, 371.

SOURCE: 45 FR 12684, Feb. 26, 1980, unless otherwise noted.

### Subpart A—General Provisions

#### § 884.1 Scope.

(a) This part sets forth the classification of obstetrical and gynecological devices intended for human use that are in commercial distribution.

(b) The identification of a device in a regulation in this part is not a precise description of every device that is, or will be, subject to the regulation. A manufacturer who submits a premarket notification submission for a device under part 807 may not show merely that the device is accurately described by the section title and identification provisions of a regulation in this part, but shall state why the device is substantially equivalent to other devices, as required by § 807.87.

(c) To avoid duplicative listings, an obstetrical and gynecological device that has two or more types of uses (e.g., used both as a diagnostic device

and as a therapeutic device) is listed only in one subpart.

(d) References in this part to regulatory sections of the Code of Federal Regulations are to chapter I of title 21, unless otherwise noted.

(e) Guidance documents referenced in this part are available on the Internet at <http://www.fda.gov/MedicalDevices/DeviceRegulationandGuidance/GuidanceDocuments/default.htm>.

[52 FR 17740, May 11, 1987, as amended at 68 FR 44415, Aug. 27, 2003; 78 FR 18233, Mar. 26, 2013]

#### § 884.3 Effective dates of requirement for premarket approval.

A device included in this part that is classified into class III (premarket approval) shall not be commercially distributed after the date shown in the regulation classifying the device unless the manufacturer has an approval under section 515 of the act (unless an exemption has been granted under section 520(g)(2) of the act). An approval under section 515 of the act consists of FDA's issuance of an order approving an application for premarket approval (PMA) for the device or declaring completed a product development protocol (PDP) for the device.

(a) Before FDA requires that a device commercially distributed before the enactment date of the amendments, or a device that has been found substantially equivalent to such a device, has an approval under section 515 of the act FDA must promulgate a regulation under section 515(b) of the act requiring such approval, except as provided in paragraph (b) of this section. Such a regulation under section 515(b) of the act shall not be effective during the grace period ending on the 90th day after its promulgation or on the last day of the 30th full calendar month after the regulation that classifies the device into class III is effective, whichever is later. See section 501(f)(2)(B) of the act. Accordingly, unless an effective date of the requirement for premarket approval is shown in the regulation for a device classified into class III in this part, the device may be commercially distributed without FDA's issuance of an order approving a PMA or declaring completed a PDP for the

device. If FDA promulgates a regulation under section 515(b) of the act requiring premarket approval for a device, section 501(f)(1)(A) of the act applies to the device.

(b) Any new, not substantially equivalent, device introduced into commercial distribution on or after May 28, 1976, including a device formerly marketed that has been substantially altered, is classified by statute (section 513(f) of the act) into class III without any grace period and FDA must have issued an order approving a PMA or declaring completed a PDP for the device before the device is commercially distributed unless it is reclassified. If FDA knows that a device being commercially distributed may be a “new” device as defined in this section because of any new intended use or other reasons, FDA may codify the statutory classification of the device into class III for such new use. Accordingly, the regulation for such a class III device states that as of the enactment date of the amendments, May 28, 1976, the device must have an approval under section 515 of the act before commercial distribution.

[52 FR 17740, May 11, 1987]

**§ 884.9 Limitations of exemptions from section 510(k) of the Federal Food, Drug, and Cosmetic Act (the act).**

The exemption from the requirement of premarket notification (section 510(k) of the act) for a generic type of class I or II device is only to the extent that the device has existing or reasonably foreseeable characteristics of commercially distributed devices within that generic type or, in the case of in vitro diagnostic devices, only to the extent that misdiagnosis as a result of using the device would not be associated with high morbidity or mortality. Accordingly, manufacturers of any commercially distributed class I or II device for which FDA has granted an exemption from the requirement of premarket notification must still submit a premarket notification to FDA before introducing or delivering for introduction into interstate commerce for commercial distribution the device when:

(a) The device is intended for a use different from the intended use of a le-

gally marketed device in that generic type of device; e.g., the device is intended for a different medical purpose, or the device is intended for lay use where the former intended use was by health care professionals only;

(b) The modified device operates using a different fundamental scientific technology than a legally marketed device in that generic type of device; e.g., a surgical instrument cuts tissue with a laser beam rather than with a sharpened metal blade, or an in vitro diagnostic device detects or identifies infectious agents by using deoxyribonucleic acid (DNA) probe or nucleic acid hybridization technology rather than culture or immunoassay technology; or

(c) The device is an in vitro device that is intended:

(1) For use in the diagnosis, monitoring, or screening of neoplastic diseases with the exception of immunohistochemical devices;

(2) For use in screening or diagnosis of familial or acquired genetic disorders, including inborn errors of metabolism;

(3) For measuring an analyte that serves as a surrogate marker for screening, diagnosis, or monitoring life-threatening diseases such as acquired immune deficiency syndrome (AIDS), chronic or active hepatitis, tuberculosis, or myocardial infarction or to monitor therapy;

(4) For assessing the risk of cardiovascular diseases;

(5) For use in diabetes management;

(6) For identifying or inferring the identity of a microorganism directly from clinical material;

(7) For detection of antibodies to microorganisms other than immunoglobulin G (IgG) or IgG assays when the results are not qualitative, or are used to determine immunity, or the assay is intended for use in matrices other than serum or plasma;

(8) For noninvasive testing as defined in § 812.3(k) of this chapter; and

(9) For near patient testing (point of care).

[65 FR 2319, Jan. 14, 2000]



### Subpart B—Obstetrical and Gynecological Diagnostic Devices

#### § 884.1040 Viscometer for cervical mucus.

(a) *Identification.* A viscometer for cervical mucus is a device that is intended to measure the relative viscoelasticity of cervical mucus collected from a female patient. Measurements of relative viscoelasticity are intended for use as an adjunct in the clinical evaluation of a female with chronic infertility, to determine the time of ovulation and the penetrability of cervical mucus to motile sperm.

(b) *Classification.* Class I (general controls). The device is exempt from the premarket notification procedures in subpart E of part 807 of this chapter subject to § 884.9.

[47 FR 14706, Apr. 6, 1982, as amended at 65 FR 2320, Jan. 14, 2000]

#### § 884.1050 Endocervical aspirator.

(a) *Identification.* An endocervical aspirator is a device designed to remove tissue from the endocervix (mucous membrane lining the canal of the cervix of the uterus) by suction with a syringe, bulb and pipette, or catheter. This device is used to evaluate endocervical tissue to detect malignant and premalignant lesions.

(b) *Classification.* Class II (performance standards).

#### § 884.1060 Endometrial aspirator.

(a) *Identification.* An endometrial aspirator is a device designed to remove materials from the endometrium (the mucosal lining of the uterus) by suction with a syringe, bulb and pipette, or catheter. This device is used to study endometrial cytology (cells).

(b) *Classification.* Class II. The special controls for this device are:

(1) FDA's:

(i) "Use of International Standard ISO 10993 'Biological Evaluation of Medical Devices—Part I: Evaluation and Testing,'" and

(ii) "510(k) Sterility Review Guidance of 2/12/90 (K90-1),"

(2) Labeling:

(i) Indication: Only to evaluate the endometrium, and

(ii) Contraindications: Pregnancy, history of uterine perforation, or a recent cesarean section, and

(3) The sampling component is covered within vagina.

[45 FR 12684, Feb. 26, 1980, as amended at 52 FR 17741, May 11, 1987; 65 FR 17146, Mar. 31, 2000]

#### § 884.1100 Endometrial brush.

(a) *Identification.* An endometrial brush is a device designed to remove samples of the endometrium (the mucosal lining of the uterus) by brushing its surface. This device is used to study endometrial cytology (cells).

(b) *Classification.* Class II. The special controls for this device are:

(1) FDA's:

(i) "Use of International Standard ISO 10993 'Biological Evaluation of Medical Devices—Part I: Evaluation and Testing,'" and

(ii) "510(k) Sterility Review Guidance of 2/12/90 (K90-1),"

(2) Labeling:

(i) Indication: Only to evaluate the endometrium, and

(ii) Contraindications: Pregnancy, history of uterine perforation, or a recent cesarean section, and

(3) Design and testing:

(i) The sampling component is covered within the vagina, and

(ii) For adherence of the bristles and brush head.

[45 FR 12684, Feb. 26, 1980, as amended at 52 FR 17741, May 11, 1987; 65 FR 17146, Mar. 31, 2000]

#### § 884.1175 Endometrial suction curette and accessories.

(a) *Identification.* An endometrial suction curette is a device used to remove material from the uterus and from the mucosal lining of the uterus by scraping and vacuum suction. This device is used to obtain tissue for biopsy or for menstrual extraction. This generic type of device may include catheters, syringes, and tissue filters or traps.

(b) *Classification.* Class II (performance standards).

#### § 884.1185 Endometrial washer.

(a) *Identification.* An endometrial washer is a device used to remove materials from the endometrium (the

**§ 884.1300**

mucosal lining of the uterus) by washing with water or saline solution and then aspirating with negative pressure. This device is used to study endometrial cytology (cells).

(b) *Classification.* Class II. The special controls for this device are:

(1) FDA's:

(i) "Use of International Organization for Standardization's ISO 10993 'Biological Evaluation of Medical Devices—Part I: Evaluation and Testing,'" and

(ii) "510(k) Sterility Review Guidance of 2/12/90 (K90-1),"

(2) Labeling:

(i) Indication: Only to evaluate the endometrium,

(ii) Contraindications: Pregnancy, history of uterine perforation, or a recent cesarean section, and

(iii) Warning: Do not attach to a wall or any external suction, and

(3) Design and Testing:

(i) The sampling component is covered within the vagina, and

(ii) Intrauterine pressure should not exceed 50 millimeters of mercury.

[45 FR 12684, Feb. 26, 1980, as amended at 52 FR 17741, May 11, 1987; 65 FR 17146, Mar. 31, 2000]

**§ 884.1300 Uterotubal carbon dioxide insufflator and accessories.**

(a) *Identification.* A uterotubal carbon dioxide insufflator and accessories is a device used to test the patency (lack of obstruction) of the fallopian tubes by pressurizing the uterus and fallopian tubes and filling them with carbon dioxide gas.

(b) *Classification.* Class II (performance standards).

**§ 884.1425 Perineometer.**

(a) *Identification.* A perineometer is a device consisting of a fluid-filled sack for intravaginal use that is attached to an external manometer. The devices measure the strength of the perineal muscles by offering resistance to a patient's voluntary contractions of these muscles and is used to diagnose and to correct, through exercise, urinary incontinence or sexual dysfunction.

(b) *Classification.* Class II (performance standards).

**21 CFR Ch. I (4–1–20 Edition)**

**§ 884.1550 Amniotic fluid sampler (amniocentesis tray).**

(a) *Identification.* The amniotic fluid sampler (amniocentesis tray) is a collection of devices used to aspirate amniotic fluid from the amniotic sac via a transabdominal approach. Components of the amniocentesis tray include a disposable 3 inch 20 gauge needle with stylet and a 30 cc. syringe, as well as the various sample collection accessories, such as vials, specimen containers, medium, drapes, etc. The device is used at 16–18 weeks gestation for antepartum diagnosis of certain congenital abnormalities or anytime after 24 weeks gestation when used to assess fetal maturity.

(b) *Classification.* Class I (general controls). The device is exempt from the premarket notification procedures in subpart E of part 807 of this chapter subject to the limitations in § 884.9.

[61 FR 1123, Jan. 16, 1996, as amended at 66 FR 33808, July 25, 2001]

**§ 884.1560 Fetal blood sampler.**

(a) *Identification.* A fetal blood sampler is a device used to obtain fetal blood transcervically through an endoscope by puncturing the fetal skin with a short blade and drawing blood into a heparinized tube. The fetal blood pH is determined and used in the diagnosis of fetal distress and fetal hypoxia.

(b) *Classification.* Class II (performance standards).

**§ 884.1600 Transabdominal amnioscope (fetoscope) and accessories.**

(a) *Identification.* A transabdominal amnioscope is a device designed to permit direct visual examination of the fetus by a telescopic system via abdominal entry. The device is used to ascertain fetal abnormalities, to obtain fetal blood samples, or to obtain fetal tissue. This generic type of device may include the following accessories: trocar and cannula, instruments used through an operating channel or through a separate cannula associated with the amnioscope, light source and cables, and component parts.

(b) *Classification.* Class III (premarket approval).

(c) *Date premarket approval application (PMA) or notice of completion of a product development protocol (PDP) is required.* A PMA or a notice of completion of a PDP is required to be filed with the Food and Drug Administration on or before January 29, 1987 for any transabdominal amnioscope (fetoscope) and accessories that was in commercial distribution before May 28, 1976, or that has on or before January 29, 1987 been found to be substantially equivalent to a transabdominal amnioscope (fetoscope) and accessories that was in commercial distribution before May 28, 1976. Any other transabdominal amnioscope (fetoscope) and accessories shall have an approved PMA or a declared completed PDP in effect before being placed in commercial distribution.

[45 FR 12684, Feb. 26, 1980, as amended at 51 FR 39845, Oct. 31, 1986]

#### § 884.1630 Colposcope.

(a) *Identification.* A colposcope is a device designed to permit direct viewing of the tissues of the vagina and cervix by a telescopic system located outside the vagina. It is used to diagnose abnormalities and select areas for biopsy. This generic type of device may include a light source, cables, and component parts.

(b) *Classification.* Class II (special controls). The device, when it is a standard colposcope (or colpomicroscope) that uses only a white light source, does not use filters other than a green filter, does not include image analysis software, and is not smartphone-based, is exempt from the premarket notification procedures in subpart E of part 807 of this chapter subject to the limitations in § 884.9.

[45 FR 12684, Feb. 26, 1980, as amended at 84 FR 71816, Dec. 30, 2019]

#### § 884.1640 Culoscope and accessories.

(a) *Identification.* A culdoscope is a device designed to permit direct viewing of the organs within the peritoneum by a telescopic system introduced into the pelvic cavity through the posterior vaginal fornix. It is used to perform diagnostic and surgical procedures on the female genital organs. This generic type of device may in-

clude trocar and cannula, instruments used through an operating channel, scope preheaters, light source and cables, and component parts.

(b) *Classification.* (1) Class II (performance standards).

(2) Class I for culdoscope accessories that are not part of a specialized instrument or device delivery system; do not have adapters, connectors, channels, or do not have portals for electrosurgical, laser, or other power sources. Such culdoscope accessory instruments include: lens cleaning brush, biopsy brush, clip applier (without clips), applicator, cannula (without trocar or valves), ligature carrier/needle holder, clamp/hemostat/grasper, curette, instrument guide, ligature passing and knotting instrument, suture needle (without suture), retractor, mechanical (noninflatable), snare, stylet, forceps, dissector, mechanical (noninflatable) scissors, and suction/irrigation probe. The devices subject to this paragraph (b)(2) are exempt from the premarket notification procedures in subpart E of part 807 of this chapter, subject to the limitations in § 884.9.

[45 FR 12684, Feb. 26, 1980, as amended at 61 FR 1123, Jan. 16, 1996; 66 FR 38808, July 25, 2001]

#### § 884.1660 Transcervical endoscope (amnioscope) and accessories.

(a) *Identification.* A transcervical endoscope is a device designed to permit direct viewing of the fetus and amniotic sac by means of an open tube introduced into the uterus through the cervix. The device may be used to visualize the fetus or amniotic fluid and to sample fetal blood or amniotic fluid. This generic type of device may include obturators, instruments used through an operating channel, light sources and cables, and component parts.

(b) *Classification.* Class II (performance standards).

#### § 884.1690 Hysteroscope and accessories.

(a) *Identification.* A hysteroscope is a device used to permit direct viewing of the cervical canal and the uterine cavity by a telescopic system introduced into the uterus through the cervix. It is used to perform diagnostic and surgical

## § 884.1700

## 21 CFR Ch. I (4–1–20 Edition)

procedures other than sterilization. This generic type of device may include obturators and sheaths, instruments used through an operating channel, scope preheaters, light sources and cables, and component parts.

(b) *Classification.* (1) Class II (performance standards).

(2) Class I for hysteroscope accessories that are not part of a specialized instrument or device delivery system; do not have adapters, connectors, channels, or do not have portals for electrosurgical, laser, or other power sources. Such hysteroscope accessory instruments include: lens cleaning brush, cannula (without trocar or valves), clamp/hemostat/grasper, curette, instrument guide, forceps, dissector, mechanical (noninflatable), and scissors. The devices subject to this paragraph (b)(2) are exempt from the premarket notification procedures in subpart E of part 807 of this chapter, subject to the limitations in § 884.9.

[45 FR 12684, Feb. 26, 1980, as amended at 61 FR 1123, Jan. 16, 1996; 66 FR 38808, July 25, 2001]

### § 884.1700 Hysteroscopic insufflator.

(a) *Identification.* A hysteroscopic insufflator is a device designed to distend the uterus by filling the uterine cavity with a liquid or gas to facilitate viewing with a hysteroscope.

(b) *Classification.* (1) Class II (performance standards).

(2) Class I for tubing and tubing/filter fits which only include accessory instruments that are not used to effect intrauterine access, e.g., hysteroscopic introducer sheaths, etc.; and single-use tubing kits used for only intrauterine insufflation. The devices subject to this paragraph (b)(2) are exempt from the premarket notification procedures in subpart E of part 807 of this chapter, subject to the limitations in § 884.9.

[45 FR 12684, Feb. 26, 1980, as amended at 61 FR 1124, Jan. 16, 1996; 66 FR 38808, July 25, 2001]

### § 884.1710 Closed loop hysteroscopic insufflator with cutter-coagulator.

(a) *Identification.* A closed loop hysteroscopic insufflator with cutter-coagulator is a prescription device configured for hysteroscopic insufflation, resection, and coagulation. It is used to

perform diagnostic and surgical procedures (*i.e.*, resection and coagulation). This device type contains a closed-loop recirculating fluid management system for the controlled delivery of filtered distension fluid. This device type also contains a bipolar radiofrequency device used in conjunction with a hysteroscope for resection and coagulation of intrauterine tissues.

(b) *Classification.* Class II (special controls). The special control(s) for this device are:

(1) The patient-contacting components of the device must be demonstrated to be biocompatible.

(2) Software validation, verification, and hazard analysis must be provided.

(3) Electrical equipment safety, including appropriate thermal and mechanical safety and electromagnetic compatibility (EMC) testing must be performed.

(4) Device components that are labeled sterile must be validated to a sterility assurance level of  $10^{-6}$ .

(5) Shelf-life testing that demonstrates the device packaging maintains sterility and the functionality of the device is maintained following simulated shipping and handling must be provided to support the proposed shelf life.

(6) Non-clinical testing data must demonstrate the performance characteristics of the device. Detailed protocols and the test reports must be provided for each test.

(i) The following tests must be performed for the resection portion of the device:

(A) Mechanical testing to assess critical joint strength.

(B) Device electrode temperature testing.

(C) Coagulation depth testing.

(D) Simulated use testing.

(E) Device durability testing.

(ii) The following tests must be performed for the fluid management portion of the device:

(A) Mechanical testing to assess tensile strength of connections.

(B) Pressure testing that demonstrates the following parameters, including accuracy of the pressure displayed; appropriate detection and response to overpressure conditions; activation of a secondary overpressure relief valve at the maximum safe level; and all accessories within the fluid path meet the pressure requirements.

(C) Fluid delivery volume testing that demonstrates that the maximum fluid volume delivered is below a predefined level.

(D) Flow rate testing.

(E) Simulated use testing.

(F) Filtration testing.

(G) Blood filtration capacity testing.

(H) Tissue collection capacity testing.

(I) Filtrate characterization and testing that demonstrates that the continuous reintroduction of filtrate into the uterus does not pose a safety risk.

(7) Clinician labeling must include:

(i) Specific instructions and the clinical training needed for the safe use of the device.

(ii) Appropriate warnings, precautions, and information related to overpressurization.

(iii) Appropriate EMC information.

(iv) An expiration date/shelf life.

[82 FR 35073, July 28, 2017]

#### § 884.1720 Gynecologic laparoscope and accessories.

(a) *Identification.* A gynecologic laparoscope is a device used to permit direct viewing of the organs within the peritoneum by a telescopic system introduced through the abdominal wall. It is used to perform diagnostic and surgical procedures on the female genital organs. This generic type of device may include: Trocar and cannula, instruments used through an operating channel, scope preheater, light source and cables, and component parts.

(b) *Classification.* (1) Class II (performance standards).

(2) Class I for gynecologic laparoscope accessories that are not part of a specialized instrument or device delivery system, do not have adapters, connector channels, or do not have portals for electrosurgical, lasers, or other power sources. Such gynecologic laparoscope accessory instruments include: the lens cleaning

brush, biopsy brush, clip applier (without clips), applicator, cannula (without trocar or valves), ligature carrier/needle holder, clamp/hemostat/grasper, curette, instrument guide, ligature passing and knotting instrument, suture needle (without suture), retractor, mechanical (noninflatable), snare, stylet, forceps, dissector, mechanical (noninflatable), scissors, and suction/irrigation probe. The devices subject to this paragraph (b)(2) are exempt from the premarket notification procedures in subpart E of part 807 of this chapter, subject to the limitations in § 884.9.

[45 FR 12684, Feb. 26, 1980, as amended at 61 FR 1124, Jan. 16, 1996; 66 FR 38808, July 25, 2001]

#### § 884.1730 Laparoscopic insufflator.

(a) *Identification.* A laparoscopic insufflator is a device used to facilitate the use of the laparoscope by filling the peritoneal cavity with gas to distend it.

(b) *Classification.* (1) Class II (performance standards).

(2) Class I for tubing and tubing/filter kits which include accessory instruments that are not used to effect intra-abdominal insufflation (pneumoperitoneum). The devices subject to this paragraph (b)(2) are exempt from the premarket notification procedures in subpart E of part 807 of this chapter, subject to the limitations in § 884.9.

[45 FR 12684, Feb. 26, 1980, as amended at 61 FR 1124, Jan. 16, 1996; 66 FR 38809, July 25, 2001]

### Subpart C—Obstetrical and Gynecological Monitoring Devices

#### § 884.2050 Obstetric data analyzer.

(a) *Identification.* An obstetric data analyzer (fetal status data analyzer) is a device used during labor to analyze electronic signal data obtained from fetal and maternal monitors. The obstetric data analyzer provides clinical diagnosis of fetal status and recommendations for labor management and clinical interventions. This generic type of device may include signal analysis and display equipment, electronic interfaces for other equipment, and power supplies and component parts.

**§ 884.2225**

**21 CFR Ch. I (4–1–20 Edition)**

(b) *Classification*. Class III (premarket approval).

(c) *Date PMA or notice of completion of PDP is required*. A PMA or a notice of completion of a PDP is required to be filed with the Food and Drug Administration on or before October 3, 2000, for any obstetric data analyzer described in paragraph (a) of this section that was in commercial distribution before May 28, 1976, or that has been found, on or before October 3, 2000, to be substantially equivalent to an obstetric data analyzer described in paragraph (a) of this section that was in commercial distribution before May 28, 1976. Any other obstetric data analyzer described in paragraph (a) of this section shall have an approved PMA or declared completed PDP in effect before being placed in commercial distribution.

[65 FR 41332, July 5, 2000]

**§ 884.2225 Obstetric-gynecologic ultrasonic imager.**

(a) *Identification*. An obstetric-gynecologic ultrasonic imager is a device designed to transmit and receive ultrasonic energy into and from a female patient by pulsed echoscopy. This device is used to provide a visual representation of some physiological or artificial structure, or of a fetus, for diagnostic purposes during a limited period of time. This generic type of device may include the following: signal analysis and display equipment, electronic interfaces for other equipment, patient and equipment supports, coupling gel, and component parts. This generic type of device does not include devices used to monitor the changes in some physiological condition over long periods of time.

(b) *Classification*. Class II (performance standards).

**§ 884.2600 Fetal cardiac monitor.**

(a) *Identification*. A fetal cardiac monitor is a device used to ascertain fetal heart activity during pregnancy and labor. The device is designed to separate fetal heart signals from maternal heart signals by analyzing electrocardiographic signals (electrical potentials generated during contraction and relaxation of heart muscle) obtained from the maternal abdomen with external electrodes. This generic

type of device may include an alarm that signals when the heart rate crosses a preset threshold. This generic type of device includes the “fetal cardi tachometer (with sensors)” and the “fetal electrocardiographic monitor.”

(b) *Classification*. Class II (performance standards).

**§ 884.2620 Fetal electroencephalographic monitor.**

(a) *Identification*. A fetal electroencephalographic monitor is a device used to detect, measure, and record in graphic form (by means of one or more electrodes placed transcervically on the fetal scalp during labor) the rhythmically varying electrical skin potentials produced by the fetal brain.

(b) *Classification*. Class III (premarket approval).

(c) *Date PMA or notice of completion of a PDP is required*. A PMA or a notice of completion of a PDP is required to be filed with the Food and Drug Administration on or before December 26, 1996 for any fetal electroencephalographic monitor that was in commercial distribution before May 28, 1976, or that has, on or before December 26, 1996 been found to be substantially equivalent to a fetal electroencephalographic monitor in commercial distribution before May 28, 1976. Any other fetal electroencephalographic monitor shall have an approved PMA or a declared completed PDP in effect before being placed in commercial distribution.

[45 FR 12684, Feb. 26, 1980, as amended at 52 FR 17741, May 11, 1987; 61 FR 50708, Sept. 27, 1996]

**§ 884.2640 Fetal phonocardiographic monitor and accessories.**

(a) *Identification*. A fetal phonocardiographic monitor is a device designed to detect, measure, and record fetal heart sounds electronically, in graphic form, and noninvasively, to ascertain fetal condition during labor. This generic type of device includes the following accessories: signal analysis and display equipment, patient and equipment supports, and other component parts.

(b) *Classification*. Class II (performance standards).

**§ 884.2660 Fetal ultrasonic monitor and accessories.**

(a) *Identification.* A fetal ultrasonic monitor is a device designed to transmit and receive ultrasonic energy into and from the pregnant woman, usually by means of continuous wave (doppler) echoscopy. The device is used to represent some physiological condition or characteristic in a measured value over a period of time (e.g., perinatal monitoring during labor) or in an immediately perceptible form (e.g., use of the ultrasonic stethoscope). This generic type of device may include the following accessories: signal analysis and display equipment, electronic interfaces for other equipment, patient and equipment supports, and component parts. This generic type of device does not include devices used to image some relatively unchanging physiological structure or interpret a physiological condition, but does include devices which may be set to alarm automatically at a predetermined threshold value.

(b) *Classification.* Class II (performance standards).

**§ 884.2675 Fetal scalp circular (spiral) electrode and applicator.**

(a) *Identification.* A fetal scalp circular (spiral) electrode and applicator is a device used to obtain a fetal electrocardiogram during labor and delivery. It establishes electrical contact between fetal skin and an external monitoring device by a shallow subcutaneous puncture of fetal scalp tissue with a curved needle or needles. This generic type of device includes nonreusable spiral electrodes and reusable circular electrodes.

(b) *Classification.* Class II (performance standards).

**§ 884.2685 Fetal scalp clip electrode and applicator.**

(a) *Identification.* A fetal scalp clip electrode and applicator is a device designed to establish electrical contact between fetal skin and an external monitoring device by means of pinching skin tissue with a nonreusable clip. This device is used to obtain a fetal electrocardiogram. This generic type of device may include a clip electrode applicator.

(b) *Classification.* Class III (premarket approval).

(c) *Date PMA or notice of completion of a PDP is required.* A PMA or a notice of completion of a PDP is required to be filed with the Food and Drug Administration on or before December 26, 1996 for any fetal scalp clip electrode and applicator that was in commercial distribution before May 28, 1976, or that has, on or before December 26, 1996 been found to be substantially equivalent to a fetal scalp clip electrode and applicator that was in commercial distribution before May 28, 1976. Any other fetal scalp clip electrode and applicator shall have an approved PMA or a declared completed PDP in effect before being placed in commercial distribution.

[45 FR 12684, Feb. 26, 1980, as amended at 52 FR 17741, May 11, 1987; 61 FR 50708, Sept. 27, 1996]

**§ 884.2700 Intrauterine pressure monitor and accessories.**

(a) *Identification.* An intrauterine pressure monitor is a device designed to detect and measure intrauterine and amniotic fluid pressure with a catheter placed transcervically into the uterine cavity. The device is used to monitor intensity, duration, and frequency of uterine contractions during labor. This generic type of device may include the following accessories: signal analysis and display equipment, patient and equipment supports, and component parts.

(b) *Classification.* Class II (performance standards).

**§ 884.2720 External uterine contraction monitor and accessories.**

(a) *Identification.* An external uterine contraction monitor (i.e., the tokodynamometer) is a device used to monitor the progress of labor. It measures the duration, frequency, and relative pressure of uterine contractions with a transducer strapped to the maternal abdomen. This generic type of device may include an external pressure transducer, support straps, and other patient and equipment supports.

(b) *Classification.* Class II (performance standards).

## § 884.2730

## 21 CFR Ch. I (4–1–20 Edition)

### § 884.2730 Home uterine activity monitor.

(a) *Identification.* A home uterine activity monitor (HUAM) is an electronic system for at home antepartum measurement of uterine contractions, data transmission by telephone to a clinical setting, and for receipt and display of the uterine contraction data at the clinic. The HUAM system comprises a tocotransducer, an at-home recorder, a modem, and a computer and monitor that receive, process, and display data. This device is intended for use in women with a previous preterm delivery to aid in the detection of preterm labor.

(b) *Classification.* Class II (special controls); guidance document (Class II Special Controls Guidance for Home Uterine Activity Monitors).

[66 FR 14076, Mar. 9, 2001]

### § 884.2740 Perinatal monitoring system and accessories.

(a) *Identification.* A perinatal monitoring system is a device used to show graphically the relationship between maternal labor and the fetal heart rate by means of combining and coordinating uterine contraction and fetal heart monitors with appropriate displays of the well-being of the fetus during pregnancy, labor, and delivery. This generic type of device may include any of the devices subject to §§ 884.2600, 884.2640, 884.2660, 884.2675, 884.2700, and 884.2720. This generic type of device may include the following accessories: Central monitoring system and remote repeaters, signal analysis and display equipment, patient and equipment supports, and component parts.

(b) *Classification.* Class II (performance standards).

### § 884.2800 Computerized Labor Monitoring System.

(a) *Identification.* A computerized labor monitoring system is a system intended to continuously measure cervical dilation and fetal head descent and provide a display that indicates the progress of labor. The computerized labor monitoring system includes a monitor and ultrasound transducers. Ultrasound transducers are placed on

the maternal abdomen and cervix and on the fetal scalp to provide the matrix of measurements used to produce the display.

(b) *Classification.* Class II (special controls). The special controls are the FDA guidance document entitled: “Guidance for Industry and Food and Drug Administration Staff; Class II Special Controls Guidance Document: Computerized Labor Monitoring Systems.” See § 884.1(e) for availability of this guidance document.

[72 FR 20227, Apr. 24, 2007]

### § 884.2900 Fetal stethoscope.

(a) *Identification.* A fetal stethoscope is a device used for listening to fetal heart sounds. It is designed to transmit the fetal heart sounds not only through sound channels by air conduction, but also through the user’s head by tissue conduction into the user’s ears. It does not use ultrasonic energy. This device is designed to eliminate noise interference commonly caused by handling conventional stethoscopes.

(b) *Classification.* Class I (general controls). The device is exempt from the premarket notification procedures in subpart E of part 807 of this chapter, subject to the limitations in § 884.9.

[45 FR 12684, Feb. 26, 1980, as amended at 66 FR 38809, July 25, 2001]

### § 884.2960 Obstetric ultrasonic transducer and accessories.

(a) *Identification.* An obstetric ultrasonic transducer is a device used to apply ultrasonic energy to, and to receive ultrasonic energy from, the body in conjunction with an obstetric monitor or imager. The device converts electrical signals into ultrasonic energy, and vice versa, by means of an assembly distinct from an ultrasonic generator. This generic type of device may include the following accessories: coupling gel, preamplifiers, amplifiers, signal conditioners with their power supply, connecting cables, and component parts. This generic type of device does not include devices used to generate the ultrasonic frequency electrical signals for application.

(b) *Classification.* Class II (performance standards).



**§ 884.2980 Telethermographic system.**

(a) *Telethermographic system intended for adjunctive diagnostic screening for detection of breast cancer or other uses*—(1) *Identification.* A telethermographic system for adjunctive diagnostic screening for detection of breast cancer or other uses is an electrically powered device with a detector that is intended to measure, without touching the patient's skin, the self-emanating infrared radiation that reveals the temperature variations of the surface of the body. This generic type of device may include signal analysis and display equipment, patient and equipment supports, component parts, and accessories.

(2) *Classification.* Class I (general controls).

(b) *Telethermographic system intended for use alone in diagnostic screening for detection of breast cancer or other uses*—

(1) *Identification.* A telethermographic system for use as the sole diagnostic screening tool for detection of breast cancer or other uses is an electrically powered device with a detector that is intended to measure, without touching the patient's skin, the self-emanating infrared radiation that reveals the temperature variations of the surface of the body. This generic type of device may include signal analysis and display equipment, patient and equipment supports, component parts, and accessories.

(2) *Classification.* Class III.

(3) *Date PMA or notice of completion of a PDP is required.* As of the enactment date of the amendments, May 28, 1976, an approval under section 515 of the act is required before the device described in paragraph (b)(1) may be commercially distributed. See § 884.3.

[53 FR 1566, Jan. 20, 1988, as amended at 55 FR 48440, Nov. 20, 1990; 66 FR 46953, Sept. 10, 2001]

**§ 884.2982 Liquid crystal thermographic system.**

(a) *A nonelectrically powered or an AC-powered liquid crystal thermographic system intended for adjunctive use in diagnostic screening for detection of breast cancer or other uses*—(1) *Identification.* A nonelectrically powered or an AC-powered liquid crystal thermographic system intended for use as an adjunct to

physical palpation or mammography in diagnostic screening for detection of breast cancer or other uses is a nonelectrically powered or an AC-powered device applied to the skin that displays the color patterns of heat sensitive cholesteric liquid crystals that respond to temperature variations of the surface of the body. This generic type of device may include patient and equipment supports, a means to ensure thermal contact between the patient's skin and the liquid crystals, component parts, and accessories.

(2) *Classification.* Class I (general controls).

(b) A nonelectrically powered or an AC-powered liquid crystal thermographic system intended for use alone in diagnostic screening for detection of breast cancer or other uses—

(1) *Identification.* A nonelectrically powered or an AC-powered liquid crystal thermographic system intended for use as the sole diagnostic screening tool for detection of breast cancer or other uses is a nonelectrically powered or an AC-powered device applied to the skin that displays the color patterns of heat sensitive cholesteric liquid crystals that respond to temperature variations of the surface of the body. This generic type of device may include image display and recording equipment, patient and equipment supports, a means to ensure thermal contact between the patient's skin and the liquid crystals, component parts, and accessories.

(2) *Classification.* Class III.

(3) *Date PMA or notice of completion of a PDP is required.* As of the enactment date of the amendments, May 28, 1976, an approval under section 515 of the act is required before the device described in paragraph (b)(1) may be commercially distributed. See § 884.3.

[53 FR 1566, Jan. 20, 1988, as amended at 55 FR 48441, Nov. 20, 1990; 66 FR 46953, Sept. 10, 2001]

**§ 884.2990 Breast lesion documentation system.**

(a) *Identification.* A breast lesion documentation system is a device for use in producing a surface map of the breast as an aid to document palpable breast lesions identified during a clinical breast examination.

**§ 884.3200**

(b) *Classification.* Class II (special controls). The device, when it is a breast examination recording sheet, is exempt from the premarket notification procedures in subpart E of part 807 of this chapter subject to the limitations in § 884.9. The special control is FDA's guidance entitled "Class II Special Controls Guidance Document: Breast Lesion Documentation System." See § 884.1(e) for the availability of this guidance document.

[68 FR 44415, Aug. 27, 2003, as amended at 84 FR 71816, Dec. 30, 2019]

**Subpart D—Obstetrical and Gynecological Prosthetic Devices**

**§ 884.3200 Cervical drain.**

(a) *Identification.* A cervical drain is a device designed to provide an exit channel for draining discharge from the cervix after pelvic surgery.

(b) *Classification.* Class II (special controls). The device is exempt from the premarket notification procedures in subpart E of part 807 of this chapter subject to the limitations in § 884.9.

[45 FR 12684, Feb. 26, 1980, as amended at 84 FR 71816, Dec. 30, 2019]

**§ 884.3575 Vaginal pessary.**

(a) *Identification.* A vaginal pessary is a removable structure placed in the vagina to support the pelvic organs and is used to treat conditions such as uterine prolapse (falling down of uterus), uterine retroposition (backward displacement), or gynecologic hernia.

(b) *Classification.* Class II (performance standards).

**§ 884.3650 Fallopian tube prosthesis.**

(a) *Identification.* A fallopian tube prosthesis is a device designed to maintain the patency (openness) of the fallopian tube and is used after reconstructive surgery.

(b) *Classification.* Class II (performance standards).

**§ 884.3900 Vaginal stent.**

(a) *Identification.* A vaginal stent is a device used to enlarge the vagina by stretching, or to support the vagina and to hold a skin graft after reconstructive surgery.

**21 CFR Ch. I (4–1–20 Edition)**

(b) *Classification.* Class II (performance standards).

**Subpart E—Obstetrical and Gynecological Surgical Devices**

**§ 884.4050 Gynecologic laparoscopic power morcellation containment system.**

(a) *Identification.* A gynecologic laparoscopic power morcellation containment system is a prescription device consisting of an instrument port and tissue containment method that creates a working space allowing for direct visualization during a power morcellation procedure following a laparoscopic procedure for the excision of benign gynecologic tissue that is not suspected to contain malignancy.

(b) *Classification.* Class II (special controls). The special controls for this device are:

(1) The patient-contacting components of the device must be demonstrated to be biocompatible;

(2) Device components that are labeled sterile must be validated to a sterility assurance level of  $10^{-6}$ ;

(3) Performance data must support shelf life by demonstrating continued sterility of the device or the sterile components, package integrity, and device functionality over the intended shelf life;

(4) Non-clinical performance data must demonstrate that the device meets all design specifications and performance requirements. The following performance characteristics must be tested:

(i) Demonstration of the device impermeability to tissue, cells, and fluids;

(ii) Demonstration that the device allows for the insertion and withdrawal of laparoscopic instruments while maintaining pneumoperitoneum;

(iii) Demonstration that the containment system provides adequate space to perform morcellation and adequate visualization of the laparoscopic instruments and tissue specimen relative to the external viscera;

(iv) Demonstration that intended laparoscopic instruments and morcellators do not compromise the integrity of the containment system; and

(v) Demonstration that intended users can adequately deploy the device, morcellate a specimen without compromising the integrity of the device, and remove the device without spillage of contents;

(5) Training must be developed and validated to ensure users can follow the instructions for use; and

(6) Labeling must include the following:

(i) A contraindication for use in gynecologic surgery in which the tissue to be morcellated is known or suspected to contain malignancy;

(ii) Unless clinical performance data demonstrates that it can be removed or modified, a contraindication for removal of uterine tissue containing suspected fibroids in patients who are: Peri- or postmenopausal, or candidates for en bloc tissue removal, for example, through the vagina or via a mini-laparotomy incision;

(iii) The following boxed warning: “Warning: Information regarding the potential risks of a procedure with this device should be shared with patients. Uterine tissue may contain unsuspected cancer. The use of laparoscopic power morcellators during fibroid surgery may spread cancer. The use of this containment system has not been clinically demonstrated to reduce this risk.”

(iv) A statement limiting use of device to physicians who have completed the training program; and

(v) An expiration date or shelf life.

[81 FR 40183, June 21, 2016]

**§ 884.4100 Endoscopic electrocautery and accessories.**

(a) *Identification.* An endoscopic electrocautery is a device used to perform female sterilization under endoscopic observation. It is designed to coagulate fallopian tube tissue with a probe heated by low-voltage energy. This generic type of device may include the following accessories: electrical generators, probes, and electrical cables.

(b) *Classification.* Class II. The special controls for this device are:

(1) FDA’s:

(i) “Use of International Standard ISO 10993 ‘Biological Evaluation of

Medical Devices—Part I: Evaluation and Testing;”

(ii) “510(k) Sterility Review Guidance 2/12/90 (K-90),” and

(iii) “Guidance (‘Guidelines’) for Evaluation of Laproscopic Bipolar and Thermal Coagulators (and Accessories),”

(2) International Electrotechnical Commission’s IEC 60601-1-AM2 (1995-03), Amendment 2, “Medical Electrical Equipment—Part 1: General Requirements for Safety;”

(3) American National Standards Institute/American Association for Medical Instrumentation’s HF-18, 1993, “Electrosurgical Devices;”

(4) Labeling:

(i) Indication: For female tubal sterilization, and

(ii) Instructions for use:

(A) Destroy at least 2 centimeters of the fallopian tubes,

(B) Use a cut or undampened sinusoidal waveform,

(C) Use a minimum power of 25 watts, and

(D) For devices with ammeters: continue electrode activation for 5 seconds after the visual endpoint (tissue blanching) is reached or current flow ceases indicating adequate tissue destruction.

[45 FR 12684, Feb. 26, 1980, as amended at 52 FR 17741, May 11, 1987; 65 FR 17146, Mar. 31, 2000]

**§ 884.4120 Gynecologic electrocautery and accessories.**

(a) *Identification.* A gynecologic electrocautery is a device designed to destroy tissue with high temperatures by tissue contact with an electrically heated probe. It is used to excise cervical lesions, perform biopsies, or treat chronic cervicitis under direct visual observation. This generic type of device may include the following accessories: an electrical generator, a probe, and electrical cables.

(b) *Classification.* Class II (performance standards).

**§ 884.4150 Bipolar endoscopic coagulator-cutter and accessories.**

(a) *Identification.* A bipolar endoscopic coagulator-cutter is a device used to perform female sterilization and other operative procedures

§ 884.4160

21 CFR Ch. I (4-1-20 Edition)

under endoscopic observation. It destroys tissue with high temperatures by directing a high frequency electrical current through tissue between two electrical contacts of a probe. This generic type of device may include the following accessories: an electrical generator, probes, and electrical cables.

(b) *Classification.* Class II. The special controls for this device are:

(1) FDA's:

(i) "Use of International Standard ISO 10993 'Biological Evaluation of Medical Devices—Part I: Evaluation and Testing,'"

(ii) "510(k) Sterility Review Guidance 2/12/90 (K-90)," and

(iii) "Guidance ('Guidelines') for Evaluation of Laproscopic Bipolar and Thermal Coagulators (and Accessories),"

(2) International Electrotechnical Commission's IEC 60601-1-AM2 (1995-03), Amendment 2, "Medical Electrical Equipment—Part 1: General Requirements for Safety,"

(3) American National Standards Institute/American Association for Medical Instrumentation's HF-18, 1993, "Electrosurgical Devices,"

(4) Labeling:

(i) Indication: For female tubal sterilization, and

(ii) Instructions for use:

(A) Destroy at least 2 centimeters of the fallopian tubes,

(B) Use a cut or undampened sinusoidal waveform,

(C) Use a minimum power of 25 watts, and

(D) For devices with ammeters: continue electrode activation for 5 seconds after the visual endpoint (tissue blanching) is reached or current flow ceases indicating adequate tissue destruction.

[45 FR 12684, Feb. 26, 1980, as amended at 52 FR 17741, May 11, 1987; 65 FR 17146, Mar. 31, 2000]

§ 884.4160 Unipolar endoscopic coagulator-cutter and accessories.

(a) *Identification.* A unipolar endoscopic coagulator-cutter is a device designed to destroy tissue with high temperatures by directing a high frequency electrical current through the tissue between an energized probe

and a grounding plate. It is used in female sterilization and in other operative procedures under endoscopic observation. This generic type of device may include the following accessories: an electrical generator, probes and electrical cables, and a patient grounding plate. This generic type of device does not include devices used to perform female sterilization under hysteroscopic observation.

(b) *Classification.* Class II (performance standards).

§ 884.4250 Expandable cervical dilator.

(a) *Identification.* An expandable cervical dilator is an instrument with two handles and two opposing blades used manually to dilate (stretch open) the cervical os.

(b) *Classification.* Class III (premarket approval).

(c) *Date PMA or notice of completion of a PDP is required.* A PMA or a notice of completion of a PDP is required to be filed with the Food and Drug Administration on or before December 26, 1996 for any expandable cervical dilator that was in commercial distribution before May 28, 1976, or that has, on or before December 26, 1996 been found to be substantially equivalent to an expandable cervical dilator that was in commercial distribution before May 28, 1976. Any other expandable cervical dilator shall have an approved PMA or a declared completed PDP in effect before being placed in commercial distribution.

[45 FR 12684, Feb. 26, 1980, as amended at 52 FR 17741, May 11, 1987; 61 FR 50708, Sept. 27, 1996]

§ 884.4260 Hygroscopic Laminaria cervical dilator.

(a) *Identification.* A hygroscopic Laminaria cervical dilator is a device designed to dilate (stretch open) the cervical os by cervical insertion of a conical and expansible material made from the root of a seaweed (*Laminaria digitata* or *Laminaria japonica*). The device is used to induce abortion.

(b) *Classification.* Class II (performance standards).

§ 884.4270 Vibratory cervical dilators.

(a) *Identification.* A vibratory cervical dilator is a device designed to dilate

the cervical os by stretching it with a power-driven vibrating probe head. The device is used to gain access to the uterus or to induce abortion, but is not to be used during labor when a viable fetus is desired or anticipated.

(b) *Classification.* Class III (premarket approval).

(c) *Date PMA or notice of completion of a PDP is required.* A PMA or a notice of completion of a PDP is required to be filed with the Food and Drug Administration on or before December 26, 1996 for any vibratory cervical dilator that was in commercial distribution before May 28, 1976, or that has, on or before December 26, 1996 been found to be substantially equivalent to a vibratory cervical dilator that was in commercial distribution before May 28, 1976. Any other vibratory cervical dilator shall have an approved PMA or a declared completed PDP in effect before being placed in commercial distribution.

[45 FR 12684, Feb. 26, 1980, as amended at 52 FR 17741, May 11, 1987; 61 FR 50708, Sept. 27, 1996]

#### § 884.4340 Fetal vacuum extractor.

(a) *Identification.* A fetal vacuum extractor is a device used to facilitate delivery. The device enables traction to be applied to the fetal head (in the birth canal) by means of a suction cup attached to the scalp and is powered by an external vacuum source. This generic type of device may include the cup, hoses, vacuum source, and vacuum control.

(b) *Classification.* Class II (performance standards).

#### § 884.4350 Fetal head elevator.

(a) *Identification.* A fetal head elevator is a prescription device consisting of a mechanism that elevates the fetal head to facilitate delivery during a Cesarean section.

(b) *Classification.* Class II (special controls). The special controls for this device are:

(1) The patient-contacting components of the device must be demonstrated to be biocompatible.

(2) Performance data must demonstrate the sterility of patient-contacting components of the device.

(3) Performance data must support the shelf life of the device by demonstrating continued sterility, package integrity, and device functionality over the identified shelf life.

(4) Non-clinical performance data must demonstrate that the device performs as intended under anticipated conditions of use. The following performance characteristics must be tested:

(i) Reliability testing of device deployment and retrieval under relevant use conditions must be conducted.

(ii) Testing of the maximum force applied to the fetal head in an anatomic model must be conducted.

(iii) Testing of uniform application of the elevator mechanism on the fetal head must be conducted.

(5) Labeling must include the following:

(i) Contraindication for use in the presence of active genital infection;

(ii) Specific instructions regarding the proper placement and use of the device; and

(iii) A shelf life.

[82 FR 60114, Dec. 19, 2017]

#### § 884.4400 Obstetric forceps.

(a) *Identification.* An obstetric forceps is a device consisting of two blades, with handles, designed to grasp and apply traction to the fetal head in the birth passage and facilitate delivery.

(b) *Classification.* Class II (special controls). The device is exempt from the premarket notification procedures in subpart E of part 807 of this chapter subject to the limitations in § 884.9.

[45 FR 12684, Feb. 26, 1980, as amended at 84 FR 71816, Dec. 30, 2019]

#### § 884.4500 Obstetric fetal destructive instrument.

(a) *Identification.* An obstetric fetal destructive instrument is a device designed to crush or pull the fetal body to facilitate the delivery of a dead or anomalous (abnormal) fetus. This generic type of device includes the cleidoclast, cranioclast, craniotribe, and destructive hook.

(b) *Classification.* Class II (performance standards).

**§ 884.4520 Obstetric-gynecologic general manual instrument.**

(a) *Identification.* An obstetric-gynecologic general manual instrument is one of a group of devices used to perform simple obstetric and gynecologic manipulative functions. This generic type of device consists of the following:

(1) An episiotomy scissors is a cutting instrument, with two opposed shearing blades, used for surgical incision of the vulvar orifice for obstetrical purposes.

(2) A fiberoptic metal vaginal speculum is a metal instrument, with fiberoptic light, used to expose and illuminate the interior of the vagina.

(3) A metal vaginal speculum is a metal instrument used to expose the interior of the vagina.

(4) An umbilical scissors is a cutting instrument, with two opposed shearing blades, used to cut the umbilical cord.

(5) A uterine clamp is an instrument used to hold the uterus by compression.

(6) A uterine packer is an instrument used to introduce dressing into the uterus or vagina.

(7) A vaginal applicator is an instrument used to insert medication into the vagina.

(8) A vaginal retractor is an instrument used to maintain vaginal exposure by separating the edges of the vagina and holding back the tissue.

(9) A gynecological fibroid hook is an instrument used to exert traction upon a fibroid.

(10) A pelvimeter (external) is an instrument used to measure the external diameters of the pelvis.

(b) *Classification.* Class I (general controls). The devices are exempt from the premarket notification procedures in subpart E of part 807 of this chapter, subject to the limitations in § 884.9.

[45 FR 12684, Feb. 26, 1980, as amended at 54 FR 25052, June 12, 1989; 66 FR 38809, July 25, 2001]

**§ 884.4530 Obstetric-gynecologic specialized manual instrument.**

(a) *Identification.* An obstetric-gynecologic specialized manual instrument is one of a group of devices used during obstetric-gynecologic procedures to perform manipulative diag-

nostic and surgical functions (e.g., dilating, grasping, measuring, and scraping), where structural integrity is the chief criterion of device performance. This type of device consists of the following:

(1) An amniotome is an instrument used to rupture the fetal membranes.

(2) A circumcision clamp is an instrument used to compress the foreskin of the penis during circumcision of a male infant.

(3) An umbilical clamp is an instrument used to compress the umbilical cord.

(4) A uterine curette is an instrument used to scrape and remove material from the uterus.

(5) A fixed-size cervical dilator is any of a series of bougies of various sizes used to dilate the cervical os by stretching the cervix.

(6) A uterine elevator is an instrument inserted into the uterus used to lift and manipulate the uterus.

(7) A gynecological surgical forceps is an instrument with two blades and handles used to pull, grasp, or compress during gynecological examination.

(8) A cervical cone knife is a cutting instrument used to excise and remove tissue from the cervix.

(9) A gynecological cerclage needle is a looplike instrument used to suture the cervix.

(10) A hook-type contraceptive intrauterine device (IUD) remover is an instrument used to remove an IUD from the uterus.

(11) A gynecological fibroid screw is an instrument used to hold onto a fibroid.

(12) A uterine sound is an instrument used to determine the depth of the uterus by inserting it into the uterine cavity.

(13) A cytological cervical spatula is a blunt instrument used to scrape and remove cytological material from the surface of the cervix or vagina.

(14) A gynecological biopsy forceps is an instrument with two blades and handles used for gynecological biopsy procedures.

(15) A uterine tenaculum is a hook-like instrument used to seize and hold the cervix or fundus.

(16) An internal pelvimeter is an instrument used within the vagina to measure the diameter and capacity of the pelvis.

(17) A nonmetal vaginal speculum is a nonmetal instrument used to expose the interior of the vagina.

(18) A fiberoptic nonmetal vaginal speculum is a nonmetal instrument, with fiberoptic light, used to expose and illuminate the interior of the vagina.

(b) *Classification.* (1) Class II (special controls). The device, when it is an umbilical clamp with or without a cutter, a uterine tenaculum which is sterile and does not use suction and is intended for single use, a nonmetal vaginal speculum, or a fiberoptic nonmetal vaginal speculum, is exempt from the premarket notification procedures in subpart E of part 807 of this chapter subject to the limitations in § 884.9.

(2) Class I for the amniotome, uterine curette, cervical dilator (fixed-size bougies), cerclage needle, IUD remover, uterine sound, and gynecological biopsy forceps. The devices subject to this paragraph (b)(2) are exempt from the premarket notification procedures in subpart E of part 807 of this chapter, subject to the limitations in § 884.9.

[45 FR 12684, Feb. 26, 1980, as amended at 61 FR 1124, Jan. 16, 1996; 66 FR 38809, July 25, 2001; 84 FR 71816, Dec. 30, 2019]

#### § 884.4550 Gynecologic surgical laser.

(a) *Identification.* A gynecologic surgical laser is a continuous wave carbon dioxide laser designed to destroy tissue thermally or to remove tissue by radiant light energy. The device is used only in conjunction with a colposcope as part of a gynecological surgical system. A colposcope is a magnifying lens system used to examine the vagina and cervix.

(b) *Classification.* Class II (performance standards).

#### § 884.4900 Obstetric table and accessories.

(a) *Identification.* An obstetric table is a device with adjustable sections designed to support a patient in the various positions required during obstetric and gynecologic procedures. This generic type of device may include the following accessories: patient equip-

ment, support attachments, and cabinets for warming instruments and disposing of wastes.

(b) *Classification.* Class II (special controls). The device is exempt from the premarket notification procedures in subpart E of part 807 of this chapter subject to the limitations in § 884.9.

[45 FR 12684, Feb. 26, 1980, as amended at 84 FR 71816, Dec. 30, 2019]

#### § 884.4910 Specialized surgical instrumentation for use with urogynecologic surgical mesh.

(a) *Identification.* Specialized surgical instrumentation for use with urogynecologic surgical mesh is a prescription device specifically intended for use as an aid in the insertion, placement, fixation, or anchoring of surgical mesh during urogynecologic procedures. These procedures include transvaginal pelvic organ prolapse repair, sacrocolpopexy (transabdominal pelvic organ prolapse repair), and treatment of female stress urinary incontinence. Examples of specialized surgical instrumentation include needle passers and trocars, needle guides, fixation tools, and tissue anchors. This device is not a manual gastroenterology-urology surgical instrument and accessories (§ 876.4730) or a manual surgical instrument for general use (§ 878.4800).

(b) *Classification.* Class II (special controls). The special controls for specialized surgical instrumentation for use with urogynecologic surgical mesh are:

(1) The device must be demonstrated to be biocompatible;

(2) The device must be demonstrated to be sterile and, if reusable, it must be demonstrated that the device can be adequately reprocessed;

(3) Performance data must support the shelf life of the device by demonstrating package integrity and device functionality over the requested shelf life;

(4) Non-clinical performance testing must demonstrate that the device meets all design specifications and performance requirements, and that the device performs as intended under anticipated conditions of use; and

(5) Labeling must include:

**§ 884.5050**

(i) Information regarding the mesh design that may be used with the device;

(ii) Detailed summary of the clinical evaluations pertinent to use of the device;

(iii) Expiration date; and

(iv) Where components are intended to be sterilized by the user prior to initial use and/or are reusable, validated methods and instructions for sterilization and/or reprocessing of any reusable components.

[82 FR 1603, Jan. 6, 2017]

**Subpart F—Obstetrical and Gynecological Therapeutic Devices**

**§ 884.5050 Metreurynter-balloon abortion system.**

(a) *Identification.* A metreurynter-balloon abortion system is a device used to induce abortion. The device is inserted into the uterine cavity, inflated, and slowly extracted. The extraction of the balloon from the uterus causes dilation of the cervical os. This generic type of device may include pressure sources and pressure controls.

(b) *Classification.* Class III (premarket approval).

(c) *Date PMA or notice of completion of a PDP is required.* A PMA or a notice of completion of a PDP is required to be filed with the Food and Drug Administration on or before December 26, 1996 for any metreurynter-balloon abortion system that was in commercial distribution before May 28, 1976, or that has, on or before December 26, 1996 been found to be substantially equivalent to a metreurynter-balloon abortion system that was in commercial distribution before May 28, 1976. Any other metreurynter-balloon abortion system shall have an approved PMA or a declared completed PDP in effect before being placed in commercial distribution.

[45 FR 12684, Feb. 26, 1980, as amended at 52 FR 17741, May 11, 1987; 61 FR 50709, Sept. 27, 1996]

**§ 884.5070 Vacuum abortion system.**

(a) *Identification.* A vacuum abortion system is a device designed to aspirate transcervically the products of concep-

**21 CFR Ch. I (4–1–20 Edition)**

tion or menstruation from the uterus by using a cannula connected to a suction source. This device is used for pregnancy termination or menstrual regulation. This type of device may include aspiration cannula, vacuum source, and vacuum controller.

(b) *Classification.* Class II (performance standards).

**§ 884.5100 Obstetric anesthesia set.**

(a) *Identification.* An obstetric anesthesia set is an assembly of antiseptic solution, needles, needle guides, syringes, and other accessories, intended for use with an anesthetic drug. This device is used to administer regional blocks (e.g., paracervical, uterosacral, and pudendal) that may be used during labor, delivery, or both.

(b) *Classification.* Class II (performance standards).

**§ 884.5150 Nonpowered breast pump.**

(a) *Identification.* A nonpowered breast pump is a manual suction device used to express milk from the breast.

(b) *Classification.* Class I. The device is exempt from the premarket notification procedures in subpart E of part 807 of this chapter, subject to the limitations in § 884.9, if the device is using either a bulb or telescoping mechanism which does not develop more than 250 mm Hg suction, and the device materials that contact breast or breast milk do not produce cytotoxicity, irritation, or sensitization effects.

[45 FR 12684, Feb. 26, 1980, as amended at 61 FR 1124, Jan. 16, 1996; 66 FR 38809, July 25, 2001]

**§ 884.5160 Powered breast pump.**

(a) *Identification.* A powered breast pump in an electrically powered suction device used to express milk from the breast.

(b) *Classification.* Class II (performance standards).

**§ 884.5200 Hemorrhoid prevention pressure wedge.**

(a) *Identification.* A hemorrhoid prevention pressure wedge provides mechanical support to the perianal region during the labor and delivery process. External mechanical support of the



perianal region is intended to help prevent the occurrence of external hemorrhoids associated with vaginal childbirth.

(b) *Classification.* Class II (special controls). The device is exempt from the premarket notification procedures in subpart E of part 807 of this chapter subject to the limitations in § 884.9. The special controls for this device are:

(1) The sale, distribution, and use of this device are restricted to prescription use in accordance with § 801.109 of this chapter.

(2) The labeling must include specific instructions regarding the proper placement and use of the device.

(3) The device must be demonstrated to be biocompatible.

(4) Mechanical bench testing of material strength must demonstrate that the device will withstand forces encountered during use.

(5) Safety and effectiveness data must demonstrate that the device prevents hemorrhoids in women undergoing spontaneous vaginal delivery, in addition to general controls.

[76 FR 21238, Apr. 15, 2011, as amended at 84 FR 71816, Dec. 30, 2019]

**§ 884.5210 Pressure wedge for the reduction of cesarean delivery.**

(a) *Identification.* A pressure wedge for the reduction of cesarean delivery is a prescription device that provides external mechanical support to the perianal region during the labor and vaginal delivery process. External mechanical support of the perianal region is intended to help reduce the occurrence of cesarean delivery.

(b) *Classification.* Class II (special controls). The special controls for this device are:

(1) The patient contacting materials must be evaluated to be biocompatible.

(2) Nonclinical performance data must demonstrate that the device will not break when subjected to the forces it will be exposed to during labor.

(3) Performance data must validate the sterility of the device.

(4) Performance data must support the shelf life of the device by demonstrating continued sterility and package integrity over the labeled shelf life.

(5) Clinical performance data must be provided that characterizes the rate of skin/tissue trauma.

(6) The labeling must include:

(i) Specific instructions regarding the proper placement and use of the device.

(ii) A shelf life.

[82 FR 61448, Dec. 28, 2017]

**§ 884.5225 Abdominal decompression chamber.**

(a) *Identification.* An abdominal decompression chamber is a hoodlike device used to reduce pressure on the pregnant patient's abdomen for the relief of abdominal pain during pregnancy or labor.

(b) *Classification.* Class III (premarket approval).

(c) *Date PMA or notice of completion of a PDP is required.* A PMA or a notice of completion of a PDP is required to be filed with the Food and Drug Administration on or before December 26, 1996 for any abdominal decompression chamber that was in commercial distribution before May 28, 1976, or that has, on or before December 26, 1996 been found to be substantially equivalent to an abdominal decompression chamber that was in commercial distribution before May 28, 1976. Any other abdominal decompression chamber shall have an approved PMA or a declared completed PDP in effect before being placed in commercial distribution.

[45 FR 12684, Feb. 26, 1980, as amended at 52 FR 17741, May 11, 1987; 61 FR 50709, Sept. 27, 1996]

**§ 884.5250 Cervical cap.**

(a) *Identification.* A cervical cap is a flexible cuplike receptacle that fits over the cervix to collect menstrual flow or to aid artificial insemination. This generic type of device is not for contraceptive use.

(b) *Classification.* Class II (performance standards).

**§ 884.5300 Condom.**

(a) *Identification.* A condom is a sheath which completely covers the penis with a closely fitting membrane. The condom is used for contraceptive

## § 884.5310

and for prophylactic purposes (preventing transmission of sexually transmitted infections). The device may also be used to collect semen to aid in the diagnosis of infertility.

(b) *Classification*. (1) Class II (special controls) for condoms made of materials other than natural rubber latex, including natural membrane (skin) or synthetic.

(2) Class II (special controls) for natural rubber latex condoms. The guidance document entitled “Class II Special Controls Guidance Document: Labeling for Natural Rubber Latex Condoms Classified Under 21 CFR 884.5300” will serve as the special control. See § 884.1(e) for the availability of this guidance document.

[73 FR 66538, Nov. 10, 2008]

## § 884.5310 Condom with spermicidal lubricant.

(a) *Identification*. A condom with spermicidal lubricant is a sheath which completely covers the penis with a closely fitting membrane with a lubricant that contains a spermicidal agent, nonoxynol-9. This condom is used for contraceptive and prophylactic purposes (preventing transmission of venereal disease).

(b) *Classification*. Class II (performance standards).

[47 FR 49022, Oct. 29, 1982]

## § 884.5320 Glans sheath.

(a) *Identification*. A glans sheath device is a sheath which covers only the glans penis or part thereof and may also cover the area in the immediate proximity thereof, the corona and frenulum, but not the entire shaft of the penis. It is indicated only for the prevention of pregnancy and not for the prevention of sexually-transmitted diseases.

(b) *Classification*. Class III (premarket approval).

(c) *Date premarket approval application (PMA) or notice of completion of a product development protocol (PDP) is required*. A PMA or a notice of completion of a PDP is required to be filed with the Food and Drug Administration on or before September 12, 2002, for any glans sheath that was in commercial distribution before May 28, 1976, or

## 21 CFR Ch. I (4–1–20 Edition)

that has, on or before September 12, 2002, been found to be substantially equivalent to a glans sheath that was in commercial distribution before May 28, 1976. Any other glans sheath shall have an approved PMA or declared completed PDP in effect before being placed in commercial distribution.

[59 FR 67187, Dec. 29, 1994, as amended at 67 FR 40849, June 14, 2002]

## § 884.5330 Multiple-use female condom.

(a) *Identification*. A multiple-use female condom is a sheath-like device that lines the vaginal wall and is inserted into the vagina prior to the initiation of coitus. At the conclusion of coitus, the device can be reused. It is indicated for contraception and prophylactic (preventing the transmission of sexually transmitted infections) purposes.

(b) *Classification*. Class III (premarket approval).

(c) *Date PMA or notice of completion of PDP is required*. A PMA or notice of completion of a PDP is required to be filed with the Food and Drug Administration on or before November 21, 2011, for any female condom that was in commercial distribution before May 28, 1976, or that has, on or before November 21, 2011, been found to be substantially equivalent to any female condom that was in commercial distribution before May 28, 1976. Any other female condom shall have an approved PMA or declared completed PDP in effect before being placed in commercial distribution.

[65 FR 31455, May 18, 2000, as amended at 76 FR 50667, Aug. 16, 2011; 83 FR 48714, Sept. 27, 2018]

## § 884.5340 Single-use internal condom.

(a) *Identification*. A single-use internal condom is an over-the-counter sheath-like device that lines the vaginal or anal wall and is inserted into the vagina or anus prior to the initiation of coitus. At the conclusion of coitus, it is removed and discarded. It is indicated for contraception and/or prophylactic (preventing the transmission of sexually transmitted infections) purposes.

(b) *Classification.* Class II (special controls). The special controls for this device are:

(1) Clinical performance testing must evaluate the following:

(i) Rate of clinical failure of the device and rate of individual failure modes of the device based on an acute failure modes study evaluating the intended use (vaginal and/or anal intercourse); and

(ii) Cumulative pregnancy rate when using the device based on a contraceptive effectiveness study (when the device is indicated for vaginal intercourse).

(2) Viral penetration testing must demonstrate the device is an effective barrier to sexually transmitted infections.

(3) Nonclinical performance testing must demonstrate that the device performs as intended under anticipated conditions of use. The following performance characteristics must be evaluated:

(i) Mechanical testing must demonstrate the device can withstand forces under anticipated use conditions, include evaluation of tensile, tear, and burst properties of the device; and

(ii) Compatibility testing with personal lubricants must determine whether the physical properties of the device are adversely affected by use of additional lubricants.

(4) The device must be demonstrated to be biocompatible.

(5) Shelf-life testing must demonstrate that the device maintains its performance characteristics and the packaging of the device must maintain integrity for the duration of the shelf-life.

(6) Labeling of the device must include:

(i) Contraceptive effectiveness table comparing typical use and perfect use pregnancy rates with the device to other available methods of birth control;

(ii) Statement regarding the adverse events associated with the device, including potential transmission of infection, adverse tissue reaction, and ulceration or other physical trauma;

(iii) Expiration date; and

(iv) Statement regarding compatibility with additional types of personal lubricants.

[83 FR 48714, Sept. 27, 2018]

**§ 884.5350 Contraceptive diaphragm and accessories.**

(a) *Identification.* A contraceptive diaphragm is a closely fitting membrane placed between the posterior aspect of the pubic bone and the posterior vaginal fornix. The device covers the cervix completely and is used with a spermicide to prevent pregnancy. This generic type of device may include an introducer.

(b) *Classification.* Class II (performance standards).

**§ 884.5360 Contraceptive intrauterine device (IUD) and introducer.**

(a) *Identification.* A contraceptive intrauterine device (IUD) is a device used to prevent pregnancy. The device is placed high in the uterine fundus with a string extending from the device through the cervical os into the vagina. This generic type of device includes the introducer, but does not include contraceptive IUD's that function by drug activity, which are subject to the new drug provisions of the Federal Food, Drug, and Cosmetic Act (see § 310.502).

(b) *Classification.* Class III (premarket approval).

(c) *Labeling.* Labeling requirements for contraceptive IUD's are set forth in § 801.427.

(d) *Date premarket approval application (PMA) or notice of completion of a product development protocol (PDP) is required.* A PMA or a notice of completion of a PDP is required to be filed with the Food and Drug Administration on or before August 4, 1986, for any IUD and introducer that was in commercial distribution before May 28, 1976, or that has on or before August 4, 1986, been found to be substantially equivalent to an IUD and introducer that was in commercial distribution before May 28, 1976. Any other IUD and introducer shall have an approved PMA or a declared completed PDP in effect

**§ 884.5370**

before being placed in commercial distribution.

[45 FR 12684, Feb. 26, 1980, as amended at 51 FR 16649, May 5, 1986]

**§ 884.5370 Software application for contraception.**

(a) *Identification.* A software application for contraception is a device that provides user-specific fertility information for preventing a pregnancy. This device includes an algorithm that performs analysis of patient-specific data (e.g., temperature, menstrual cycle dates) to distinguish between fertile and non-fertile days, then provides patient-specific recommendations related to contraception.

(b) *Classification.* Class II (special controls). The special controls for this device are:

(1) Clinical performance testing must demonstrate the contraceptive effectiveness of the software in the intended use population.

(2) Human factors performance evaluation must be provided to demonstrate that the intended users can self-identify that they are in the intended use population and can correctly use the application, based solely on reading the directions for use for contraception.

(3) Software verification, validation, and hazard analysis must be performed. Documentation must include the following:

(i) A cybersecurity vulnerability and management process to assure software functionality; and

(ii) A description of the technical parameters of the software, including the algorithm used to determine fertility status and alerts for user inputs outside of expected ranges.

(4) Labeling must include:

(i) The following warnings and precautions:

(A) A statement that no contraceptive method is 100% effective.

(B) A statement that another form of contraception (or abstinence) must be used on days specified by the application.

(C) Statements of any factors that may affect the accuracy of the contraceptive information.

**21 CFR Ch. I (4–1–20 Edition)**

(D) A warning that the application cannot protect against sexually transmitted infections.

(ii) Hardware platform and operating system requirements.

(iii) Instructions identifying and explaining how to use the software application, including required user inputs and how to interpret the application outputs.

(iv) A summary of the clinical validation study and results, including effectiveness of the application as a stand-alone contraceptive and how this effectiveness compares to other forms of legally marketed contraceptives.

[84 FR 7995, Mar. 6, 2019]

**§ 884.5380 Contraceptive tubal occlusion device (TOD) and introducer.**

(a) *Identification.* A contraceptive tubal occlusion device (TOD) and introducer is a device designed to close a fallopian tube with a mechanical structure, e.g., a band or clip on the outside of the fallopian tube or a plug or valve on the inside. The devices are used to prevent pregnancy.

(b) *Classification.* Class III (premarket approval).

(c) *Date premarket approval application (PMA) or notice of completion of a product development protocol (PDP) is required.* A PMA or a notice of completion of a PDP is required to be filed with the Food and Drug Administration on or before December 30, 1987, for any TOD and introducer that was in commercial distribution before May 28, 1976, or that has on or before December 30, 1987, been found to be substantially equivalent to a TOD and introducer that was in commercial distribution before May 28, 1976. Any other TOD and introducer shall have an approved PMA or a declared completed PDP in effect before being placed in commercial distribution.

[45 FR 12684, Feb. 26, 1980, as amended at 52 FR 36883, Oct. 1, 1987]

**§ 884.5390 Perineal heater.**

(a) *Identification.* A perineal heater is a device designed to apply heat directly by contact, or indirectly from a radiant source, to the surface of the perineum (the area between the vulva and the anus) and is used to soothe or

to help heal the perineum after an episiotomy (incision of the vulvar orifice for obstetrical purposes).

(b) *Classification*. Class II (special controls). The device is exempt from the premarket notification procedures in subpart E of part 807 of this chapter subject to the limitations in § 884.9.

[45 FR 12684, Feb. 26, 1980, as amended at 84 FR 71816, Dec. 30, 2019]

#### § 884.5400 Menstrual cup.

(a) *Identification*. A menstrual cup is a receptacle placed in the vagina to collect menstrual flow.

(b) *Classification*. Class II (special controls). The device is exempt from the premarket notification procedures in subpart E of part 807 of this chapter subject to the limitations in § 884.9.

[45 FR 12684, Feb. 26, 1980, as amended at 84 FR 71816, Dec. 30, 2019]

#### § 884.5425 Scented or scented deodorized menstrual pad.

(a) *Identification*. A scented or scented deodorized menstrual pad is a device that is a pad made of cellulosic or synthetic material which is used to absorb menstrual or other vaginal discharge. It has scent (i.e., fragrance materials) added for aesthetic purposes (scented menstrual pad) or for deodorizing purposes (scented deodorized menstrual pad). This generic type of device includes sterile scented menstrual pads used for medically indicated conditions, but does not include menstrual pads treated with added antimicrobial agents or other drugs.

(b) *Classification*. (1) Class I (general controls) for menstrual pads made of common cellulosic and synthetic material with an established safety profile. The devices subject to this paragraph (b)(1) are exempt from the premarket notification procedures in subpart E of part 807 of this chapter, subject to the limitations in § 884.9. This exemption does not include the intralabial pads and reusable menstrual pads.

(2) Class II (special controls) for scented or scented deodorized menstrual pads made of materials not described in paragraph (b)(1). The device is exempt from the premarket notification procedures in subpart E of part 807

of this chapter subject to the limitations in § 884.9.

[45 FR 12684, Feb. 26, 1980, as amended at 45 FR 51185, Aug. 1, 1980; 61 FR 67714, Dec. 24, 1996; 66 FR 38809, July 25, 2001; 84 FR 71816, Dec. 30, 2019]

#### § 884.5435 Unscented menstrual pad.

(a) *Identification*. An unscented menstrual pad is a device that is a pad made of cellulosic or synthetic material which is used to absorb menstrual or other vaginal discharge. This generic type of device includes sterile unscented menstrual pads used for medically indicated conditions, but does not include menstrual pads treated with scent (i.e., fragrance materials) or those with added antimicrobial agents or other drugs.

(b) *Classification*. Class I (general controls). The device is exempt from the premarket notification procedures in subpart E of part 807 of this chapter subject to the limitations in § 884.9 only when the device is made of common cellulosic and synthetic material with an established safety profile.

[45 FR 12684, Feb. 26, 1980, as amended at 61 FR 67714, Dec. 24, 1996; 65 FR 2320, Jan. 14, 2000; 73 FR 34860, June 19, 2008; 84 FR 71816, Dec. 30, 2019]

#### § 884.5460 Scented or scented deodorized menstrual tampon.

(a) *Identification*. A scented or scented deodorized menstrual tampon is a device that is a plug made of cellulosic or synthetic material that is inserted into the vagina and used to absorb menstrual or other vaginal discharge. It has scent (i.e., fragrance materials) added for aesthetic purposes (scented menstrual tampon) or for deodorizing purposes (scented deodorized menstrual tampon). This generic type of device does not include menstrual tampons treated with added antimicrobial agents or other drugs.

(b) *Classification*. Class II (performance standards).

[45 FR 12684, Feb. 26, 1980, as amended at 45 FR 51186, Aug. 1, 1980]

#### § 884.5470 Unscented menstrual tampon.

(a) *Identification*. An unscented menstrual tampon is a device that is a plug

**§ 884.5900**

**21 CFR Ch. I (4–1–20 Edition)**

made of cellulosic or synthetic material that is inserted into the vagina and used to absorb menstrual or other vaginal discharge. This generic type of device does not include menstrual tampons treated with scent (i.e., fragrance materials) or those with added antimicrobial agents or other drugs.

(b) *Classification.* Class II (performance standards).

**§ 884.5900 Therapeutic vaginal douche apparatus.**

(a) *Identification.* A therapeutic vaginal douche apparatus is a device that is a bag or bottle with tubing and a nozzle. The apparatus does not include douche solutions. The apparatus is intended and labeled for use in the treatment of medical conditions except it is not for contraceptive use. After filling the therapeutic vaginal douche apparatus with a solution, the patient uses the device to direct a stream of solution into the vaginal cavity.

(b) *Classification.* (1) Class II (performance standards).

(2) Class I if the device is operated by gravity feed. Devices subject to this paragraph (b)(2) are exempt from the premarket notification procedures in subpart E of part 807 of this chapter, subject to the limitations in § 884.9.

[45 FR 12684, Feb. 26, 1980, as amended at 61 FR 1124, Jan. 16, 1996; 66 FR 38809, July 25, 2001]

**§ 884.5920 Vaginal insufflator.**

(a) *Identification.* A vaginal insufflator is a device used to treat vaginitis by introducing medicated powder from a hand-held bulb into the vagina through an open speculum.

(b) *Classification.* Class I. The device is exempt from the premarket notification procedures in subpart E of part 807 of this chapter, subject to the limitations in § 884.9.

[45 FR 12684, Feb. 26, 1980, as amended at 54 FR 25052, June 12, 1989; 66 FR 38809, July 25, 2001]

**§ 884.5940 Powered vaginal muscle stimulator for therapeutic use.**

(a) *Identification.* A powered vaginal muscle stimulator is an electrically powered device designed to stimulate directly the muscles of the vagina with pulsating electrical current. This de-

vice is intended and labeled for therapeutic use in increasing muscular tone and strength in the treatment of sexual dysfunction. This generic type of device does not include devices used to treat urinary incontinence.

(b) *Classification.* Class III (premarket approval).

(c) *Date PMA or notice of completion of a PDP is required.* A PMA or a notice of completion of a PDP for a device is required to be filed with the Food and Drug Administration on or before July 12, 2000, for any powered vaginal muscle stimulator for therapeutic use that was in commercial distribution before May 28, 1976, or that has, on or before July 12, 2000, been found to be substantially equivalent to a powered vaginal muscle stimulator that was in commercial distribution before May 28, 1976. Any other powered vaginal muscle stimulator for therapeutic use shall have an approved PMA or declared completed PDP in effect before being placed in commercial distribution.

[45 FR 12684, Feb. 26, 1980, as amended at 52 FR 17741, May 11, 1987; 65 FR 19834, Apr. 13, 2000]

**§ 884.5960 Genital vibrator for therapeutic use.**

(a) *Identification.* A genital vibrator for therapeutic use is an electrically operated device intended and labeled for therapeutic use in the treatment of sexual dysfunction or as an adjunct to Kegel's exercise (tightening of the muscles of the pelvic floor to increase muscle tone).

(b) *Classification.* Class II (performance standards). The device is exempt from the premarket notification procedures in part 807, subpart E, of this chapter subject to the limitations in § 884.9.

[45 FR 12684, Feb. 26, 1980, as amended at 83 FR 29215, June 5, 2018]

**§ 884.5970 Clitoral engorgement device.**

(a) *Identification.* A clitoral engorgement device is designed to apply a vacuum to the clitoris. It is intended for use in the treatment of female sexual arousal disorder.

(b) *Classification.* Class II (special controls). The special control is a guidance document entitled: "Guidance for

## Food and Drug Administration, HHS

## § 884.6120

Industry and FDA Reviewers: Class II Special Controls Guidance Document for Clitoral Engorgement Devices.”

[65 FR 47306, Aug. 2, 2000]

### § 884.5980 Surgical mesh for transvaginal pelvic organ prolapse repair.

(a) *Identification.* Surgical mesh for transvaginal pelvic organ prolapse repair is a prescription device intended to reinforce soft tissue in the pelvic floor. This device is a porous implant that is made of synthetic material, non-synthetic material, or a combination of synthetic and non-synthetic materials. This device does not include surgical mesh for other intended uses (§ 878.3300 of this chapter).

(b) *Classification.* Class III (premarket approval).

(c) *Date premarket application approval or notice of completion of a product development protocol is required.* A premarket application approval or notice of completion of a product development protocol for a device is required to be filed with the Food and Drug Administration on or before July 5, 2018, for any surgical mesh described in paragraph (a) of this section that was in commercial distribution before May 28, 1976, or that has, on or before July 5, 2018, been found substantially equivalent to a surgical mesh described in paragraph (a) of this section that was in commercial distribution before May 28, 1976. Any other surgical mesh for transvaginal pelvic organ prolapse repair shall have an approved premarket application or declared completed product development protocol in effect before being placed in commercial distribution.

[81 FR 361, Jan. 5, 2016, as amended at 81 FR 369, Jan. 5, 2016]

## Subpart G—Assisted Reproduction Devices

SOURCE: 63 FR 48436, Sept. 10, 1998, unless otherwise noted.

### § 884.6100 Assisted reproduction needles.

(a) *Identification.* Assisted reproduction needles are devices used in in vitro fertilization (IVF), gamete

intrafallopian transfer (GIFT), or other assisted reproduction procedures to obtain gametes from the body or introduce gametes, zygote(s), preembryo(s) and/or embryo(s) into the body. This generic type of device may include a single or double lumen needle and component parts, including needle guides, such as those used with ultrasound.

(b) *Classification.* Class II (special controls) (mouse embryo assay information, endotoxin testing, sterilization validation, design specifications, labeling requirements, biocompatibility testing, and clinical testing).

### § 884.6110 Assisted reproduction catheters.

(a) *Identification.* Assisted reproduction catheters are devices used in in vitro fertilization (IVF), gamete intrafallopian transfer (GIFT), or other assisted reproduction procedures to introduce or remove gametes, zygote(s), preembryo(s), and/or embryo(s) into or from the body. This generic type of device may include catheters, cannulae, introducers, dilators, sheaths, stylets, and component parts.

(b) *Classification.* Class II (special controls) (mouse embryo assay information, endotoxin testing, sterilization validation, design specifications, labeling requirements, biocompatibility testing, and clinical testing).

### § 884.6120 Assisted reproduction accessories.

(a) *Identification.* Assisted reproduction accessories are a group of devices used during assisted reproduction procedures, in conjunction with assisted reproduction needles and/or assisted reproduction catheters, to aspirate, incubate, infuse, and/or maintain temperature. This generic type of device may include:

(1) Powered aspiration pumps used to provide low flow, intermittent vacuum for the aspiration of eggs (ova).

(2) Syringe pumps (powered or manual) used to activate a syringe to infuse or aspirate small volumes of fluid during assisted reproduction procedures.

(3) Collection tube warmers, used to maintain the temperature of egg (oocyte) collection tubes at or near body temperature. A dish/plate/microscope

**§ 884.6130**

stage warmer is a device used to maintain the temperature of the egg (oocyte) during manipulation.

(4) Embryo incubators, used to store and preserve gametes and/or embryos at or near body temperature.

(5) Cryopreservation instrumentation and devices, used to contain, freeze, and maintain gametes and/or embryos at an appropriate freezing temperature.

(b) *Classification.* Class II (special controls) (design specifications, labeling requirements, and clinical testing). The device, when it is a simple embryo incubator with only temperature, gas, and humidity control; a syringe pump; a collection tube warmer; a dish/plate/microscope stage warmer; or a controlled-rate cryopreservation freezer, is exempt from the premarket notification procedures in subpart E of part 807 of this chapter subject to the limitations in § 884.9.

[45 FR 12684, Feb. 26, 1980, as amended at 84 FR 71816, Dec. 30, 2019]

**§ 884.6130 Assisted reproduction microtools.**

(a) *Identification.* Assisted reproduction microtools are pipettes or other devices used in the laboratory to denude, micromanipulate, hold, or transfer human gametes or embryos for assisted hatching, intracytoplasmic sperm injection (ICSI), or other assisted reproduction methods.

(b) *Classification.* Class II (special controls) (mouse embryo assay information, endotoxin testing, sterilization validation, design specifications, labeling requirements, and clinical testing). The device, when the assisted reproduction microtools (pipettes) are manufactured from glass, is exempt from the premarket notification procedures in subpart E of part 807 of this chapter subject to the limitations in § 884.9.

[45 FR 12684, Feb. 26, 1980, as amended at 84 FR 71816, Dec. 30, 2019]

**§ 884.6140 Assisted reproduction micropipette fabrication instruments.**

(a) *Identification.* Assisted reproduction micropipette fabrication devices are instruments intended to pull, bevel, or forge a micropipette or needle for intracytoplasmic sperm injection (ICSI), in vitro fertilization (IVF) or

**21 CFR Ch. I (4–1–20 Edition)**

other similar assisted reproduction procedures.

(b) *Classification.* Class II (special controls) (design specifications, labeling requirements, and clinical testing).

**§ 884.6150 Assisted reproduction micromanipulators and microinjectors.**

(a) *Identification.* Assisted reproduction micromanipulators are devices intended to control the position of an assisted reproduction microtool. Assisted reproduction microinjectors are any device intended to control aspiration or expulsion of the contents of an assisted reproduction microtool.

(b) *Classification.* Class II (special controls) (design specifications, labeling requirements, and clinical testing). The device is exempt from the premarket notification procedures in subpart E of part 807 of this chapter subject to the limitations in § 884.9.

[45 FR 12684, Feb. 26, 1980, as amended at 84 FR 71816, Dec. 30, 2019]

**§ 884.6160 Assisted reproduction labware.**

(a) *Identification.* Assisted reproduction labware consists of laboratory equipment or supplies intended to prepare, store, manipulate, or transfer human gametes or embryos for in vitro fertilization (IVF), gamete intrafallopian transfer (GIFT), or other assisted reproduction procedures. These include syringes, IVF tissue culture dishes, IVF tissue culture plates, pipette tips, dishes, plates, and other vessels that come into physical contact with gametes, embryos or tissue culture media.

(b) *Classification.* Class II (special controls) (mouse embryo assay information, endotoxin testing, sterilization validation, design specifications, labeling requirements, and clinical testing). The device, when it is a dish or plate intended for general assisted reproduction technology procedures, is exempt from the premarket notification procedures in subpart E of part 807 of this chapter subject to the limitations in § 884.9.

[45 FR 12684, Feb. 26, 1980, as amended at 84 FR 71816, Dec. 30, 2019]



**§ 884.6165 Intravaginal culture system.**

(a) *Identification.* An intravaginal culture system is a prescription device intended for preparing, holding, and transferring human gametes or embryos during intravaginal in vitro fertilization or intravaginal culture procedures.

(b) *Classification.* Class II (special controls). The special controls for this device are:

(1) Clinical performance testing must demonstrate the following:

(i) Comfort and retention of the intravaginal culture device;

(ii) Adverse vaginal tissue reactions associated with intravaginal culture;

(iii) Maximum number of gametes and/or embryos that can be placed in a device; and

(iv) Rates of embryo development to the designated stage, implantation rates, clinical pregnancy rates, live birth rates, and any adverse events or outcomes.

(2) Nonclinical performance testing must demonstrate that the device performs as intended under anticipated conditions of use. The following performance characteristics must be demonstrated:

(i) Mouse embryo assay testing to assess embryotoxicity by evaluating the gamete and embryo-contacting device components effect on the growth and development of mouse embryos to the blastocyst stage;

(ii) Endotoxin testing on gamete and embryo-contacting components of the device;

(iii) Cleaning and disinfection validation of reusable device components;

(iv) Sterility maintenance of the culture media within the device throughout the vaginal incubation period and subsequent embryo extraction; and

(v) Ability of the device to permit oxygen and carbon dioxide exchange between the media contained within the device and the external environment throughout the vaginal incubation period.

(3) The patient-contacting components of the device must be demonstrated to be biocompatible.

(4) Performance data must demonstrate the sterility of the device components intended to be provided sterile.

(5) Shelf life testing must demonstrate that the device maintains its performance characteristics and the packaging of device components labeled as sterile maintain integrity and sterility for the duration of the shelf life.

(6) Labeling for the device must include:

(i) A detailed summary of the clinical testing, including device effectiveness, device-related complications, and adverse events;

(ii) Validated methods and instructions for reprocessing of reusable components;

(iii) The maximum number of gametes or embryos that can be loaded into the device;

(iv) A warning that informs users that the embryo development is first evaluated following intravaginal culture; and

(v) A statement that instructs the user to use legally marketed assisted reproductive technology media that contain elements to mitigate the contamination risk (*e.g.*, antibiotics) and to support continued embryonic development over the intravaginal culture period.

(7) Patient labeling must be provided and must include:

(i) Relevant warnings, precautions, and adverse effects and complications;

(ii) Information on how to use the device;

(iii) The risks and benefits associated with the use of the device; and

(iv) A summary of the principal clinical device effectiveness results.

[81 FR 379, Jan. 6, 2016]

**§ 884.6170 Assisted reproduction water and water purification systems.**

(a) *Identification.* Assisted reproduction water purification systems are devices specifically intended to generate high quality, sterile, pyrogen-free water for reconstitution of media used for aspiration, incubation, transfer or storage of gametes or embryos for in vitro fertilization (IVF) or other assisted reproduction procedures. These devices may also be intended as the final rinse for labware or other assisted reproduction devices that will contact the gametes or embryos. These devices

## § 884.6180

also include bottled water ready for reconstitution available from a vendor that is specifically intended for reconstitution of media used for aspiration, incubation, transfer, or storage of gametes or embryos for IVF or other assisted reproduction procedures.

(b) *Classification.* Class II (special controls) (mouse embryo assay information, endotoxin testing, sterilization validation, water quality testing, design specifications, labeling requirements, biocompatibility testing, and clinical testing).

## § 884.6180 Reproductive media and supplements.

(a) *Identification.* Reproductive media and supplement are products that are used for assisted reproduction procedures. Media include liquid and powder versions of various substances that come in direct physical contact with human gametes or embryos (including water, acid solutions used to treat gametes or embryos, rinsing solutions, sperm separation media, supplements, or oil used to cover the media) for the purposes of preparation, maintenance, transfer or storage. Supplements are specific reagents added to media to enhance specific properties of the media (e.g., proteins, sera, antibiotics, etc.).

(b) *Classification.* Class II (special controls) (mouse embryo assay information, endotoxin testing, sterilization validation, design specifications, labeling requirements, biocompatibility testing, and clinical testing).

## § 884.6190 Assisted reproductive microscopes and microscope accessories.

(a) *Identification.* Assisted reproduction microscopes and microscope accessories (excluding microscope stage warmers, which are classified under assisted reproduction accessories) are optical instruments used to enlarge images of gametes or embryos. Variations of microscopes and accessories used for these purposes would include phase contrast microscopes, dissecting microscopes and inverted stage microscopes.

(b) *Classification.* Class I. The device is exempt from the premarket notification procedures in subpart E of part 807

## 21 CFR Ch. I (4–1–20 Edition)

of this chapter, subject to the limitations in § 884.9.

[63 FR 48436, Sept. 10, 1998, as amended at 64 FR 62977, Nov. 18, 1999; 66 FR 38809, July 25, 2001]

## § 884.6195 Assisted Reproduction Embryo Image Assessment System.

(a) *Identification.* An Assisted Reproduction Embryo Image Assessment System is a prescription device that is designed to obtain and analyze light microscopy images of developing embryos. This device provides information to aid in the selection of embryo(s) for transfer when there are multiple embryos deemed suitable for transfer or freezing.

(b) *Classification.* Class II (special controls). The special control(s) for this device are:

(1) Clinical performance testing must demonstrate a reasonable assurance of safety and effectiveness of the device to predict embryo development. Classification performance (sensitivity and specificity) and predictive accuracy (Positive Predictive Value and Negative Predictive Value) must be assessed at the subject and embryo levels.

(2) Software validation, verification, and hazard analysis must be provided.

(3) Non-clinical performance testing data must demonstrate the performance characteristics of the device. Testing must include the following:

(i) Total light exposure and output testing;

(ii) A safety analysis must be performed based on maximum (worst-case) light exposure to embryos, which also includes the safety of the light wavelength(s) emitted by the device;

(iii) Simulated-use testing;

(iv) Mouse Embryo Assay testing to assess whether device operation impacts growth and development of mouse embryos to the blastocyst stage;

(v) Cleaning and disinfection validation of reusable components;

(vi) Package integrity and transit testing;

(vii) Hardware fail-safe validation;

(viii) Electrical equipment safety and electromagnetic compatibility testing; and

(ix) Prediction algorithm reproducibility.

(4) Labeling must include the following:

(i) A detailed summary of clinical performance testing, including any adverse events;

(ii) Specific instructions, warnings, precautions, and training needed for safe use of the device

(iii) Appropriate electromagnetic compatibility information;

(iv) Validated methods and instructions for cleaning and disinfection of reusable components; and

(v) Information identifying compatible cultureware and explain how they are used with the device.

[80 FR 10332, Feb. 26, 2015]

**§ 884.6200 Assisted reproduction laser system.**

(a) *Identification.* The assisted reproduction laser system is a device that images, targets, and controls the power and pulse duration of a laser beam used to ablate a small tangential hole in, or to thin, the zona pellucida of an embryo for assisted hatching or other assisted reproduction procedures.

(b) *Classification.* Class II (special controls). The special control is FDA's guidance document entitled "Class II Special Controls Guidance Document: Assisted Reproduction Laser Systems." See § 884.1(e) for the availability of this guidance document.

[69 FR 77624, Dec. 28, 2004]

**PART 886—OPHTHALMIC DEVICES**

**Subpart A—General Provisions**

Sec.

886.1 Scope.

886.3 Effective dates of requirement for pre-market approval.

886.9 Limitations of exemptions from section 510(k) of the Federal Food, Drug, and Cosmetic Act (the act).

**Subpart B—Diagnostic Devices**

886.1040 Ocular esthesiometer.  
886.1050 Adaptometer (biophotometer).  
886.1070 Anomaloscope.  
886.1090 Haidinger brush.  
886.1120 Ophthalmic camera.  
886.1140 Ophthalmic chair.  
886.1150 Visual acuity chart.  
886.1160 Color vision plate illuminator.  
886.1170 Color vision tester.  
886.1190 Distometer.

886.1200 Optokinetic drum.  
886.1220 Corneal electrode.  
886.1250 Euthyscope.  
886.1270 Exophthalmometer.  
886.1290 Fixation device.  
886.1300 Afterimage flasher.  
886.1320 Fornixscope.  
886.1330 Amsler grid.  
886.1340 Haploscope.  
886.1342 Strabismus detection device.  
886.1350 Keratoscope.  
886.1360 Visual field laser instrument.  
886.1375 Bagolini lens.  
886.1380 Diagnostic condensing lens.  
886.1385 Polymethylmethacrylate (PMMA) diagnostic contact lens.  
886.1390 Flexible diagnostic Fresnel lens.  
886.1395 Diagnostic Hruby fundus lens.  
886.1400 Maddox lens.  
886.1405 Ophthalmic trial lens set.  
886.1410 Ophthalmic trial lens clip.  
886.1415 Ophthalmic trial lens frame.  
886.1420 Ophthalmic lens gauge.  
886.1425 Lens measuring instrument.  
886.1430 Ophthalmic contact lens radius measuring device.  
886.1435 Maxwell spot.  
886.1450 Corneal radius measuring device.  
886.1460 Stereopsis measuring instrument.  
886.1500 Headband mirror.  
886.1510 Eye movement monitor.  
886.1570 Ophthalmoscope.  
886.1605 Perimeter.  
886.1630 AC-powered photostimulator.  
886.1640 Ophthalmic preamplifier.  
886.1650 Ophthalmic bar prism.  
886.1655 Ophthalmic Fresnel prism.  
886.1660 Gonioscopic prism.  
886.1665 Ophthalmic rotary prism.  
886.1670 Ophthalmic isotope uptake probe.  
886.1680 Ophthalmic projector.  
886.1690 Pupillograph.  
886.1700 Pupillometer.  
886.1750 Skiascopic rack.  
886.1760 Ophthalmic refractometer.  
886.1770 Manual refractor.  
886.1780 Retinoscope.  
886.1790 Nearpoint ruler.  
886.1800 Schirmer strip.  
886.1810 Tangent screen (campimeter).  
886.1840 Simulatan (including crossed cylinder).  
886.1850 AC-powered slitlamp biomicroscope.  
886.1860 Ophthalmic instrument stand.  
886.1870 Stereoscope.  
886.1880 Fusion and stereoscopic target.  
886.1905 Nystagmus tape.  
886.1910 Spectacle dissociation test system.  
886.1925 Diurnal pattern recorder system.  
886.1930 Tonometer and accessories.  
886.1940 Tonometer sterilizer.  
886.1945 Transilluminator.

**Subpart C [Reserved]**

**Subpart D—Prosthetic Devices**

- 886.3100 Ophthalmic tantalum clip.
- 886.3130 Ophthalmic conformer.
- 886.3200 Artificial eye.
- 886.3300 Absorbable implant (scleral buckling method).
- 886.3320 Eye sphere implant.
- 886.3340 Extraocular orbital implant.
- 886.3400 Keratoprosthesis.
- 886.3600 Intraocular lens.
- 886.3800 Scleral shell.
- 886.3920 Aqueous shunt.

**Subpart E—Surgical Devices**

- 886.4070 Powered corneal burr.
- 886.4100 Radiofrequency electrosurgical cautery apparatus.
- 886.4115 Thermal cautery unit.
- 886.4150 Vitreous aspiration and cutting instrument.
- 886.4155 Scleral plug.
- 886.4170 Cryophthalmic unit.
- 886.4230 Ophthalmic knife test drum.
- 886.4250 Ophthalmic electrolysis unit.
- 886.4270 Intraocular gas.
- 886.4275 Intraocular fluid.
- 886.4280 Intraocular pressure measuring device.
- 886.4300 Intraocular lens guide.
- 886.4335 Operating headlamp.
- 886.4350 Manual ophthalmic surgical instrument.
- 886.4355 Corneal inlay inserter handle.
- 886.4360 Ocular surgery irrigation device.
- 886.4370 Keratome.
- 886.4390 Ophthalmic laser.
- 886.4392 Nd:YAG laser for posterior capsulotomy and peripheral iridotomy.
- 886.4400 Electronic metal locator.
- 886.4440 AC-powered magnet.
- 886.4445 Permanent magnet.
- 886.4570 Ophthalmic surgical marker.
- 886.4610 Ocular pressure applicator.
- 886.4670 Phacofragmentation system.
- 886.4690 Ophthalmic photocoagulator.
- 886.4750 Ophthalmic eye shield.
- 886.4770 Ophthalmic operating spectacles (loupes).
- 886.4790 Ophthalmic sponge.
- 886.4855 Ophthalmic instrument table.

**Subpart F—Therapeutic Devices**

- 886.5100 Ophthalmic beta radiation source.
- 886.5120 Low-power binocular loupe.
- 886.5200 Eyelid thermal pulsation system.
- 886.5300 Tear electrostimulation device.
- 886.5310 Intranasal electrostimulation device for dry eye symptoms.
- 886.5420 Contact lens inserter/remover.
- 886.5540 Low-vision magnifier.
- 886.5600 Ptosis crutch.
- 886.5700 Eyelid weight.
- 886.5800 Ophthalmic bar reader.
- 886.5810 Ophthalmic prism reader.

- 886.5820 Closed-circuit television reading system.
- 886.5838 Nasolacrimal compression device.
- 886.5840 Magnifying spectacles.
- 886.5842 Spectacle frame.
- 886.5844 Prescription spectacle lens.
- 886.5850 Sunglasses (nonprescription).
- 886.5870 Low-vision telescope.
- 886.5900 Electronic vision aid.
- 886.5905 Oral electronic vision aid.
- 886.5910 Image intensification vision aid.
- 886.5915 Optical vision aid.
- 886.5916 Rigid gas permeable contact lens.
- 886.5918 Rigid gas permeable contact lens care products.
- 886.5925 Soft (hydrophilic) contact lens.
- 886.5928 Soft (hydrophilic) contact lens care products.
- 886.5933 [Reserved]

AUTHORITY: 21 U.S.C. 351, 360, 360c, 360e, 360j, 360f, 371.

SOURCE: 52 FR 33355, Sept. 2, 1987, unless otherwise noted.

EDITORIAL NOTE: Nomenclature changes to part 886 appear at 73 FR 35341, June 23, 2008.

**Subpart A—General Provisions**

**§ 886.1 Scope.**

(a) This part sets forth the classification of ophthalmic devices intended for human use that are in commercial distribution.

(b) The identification of a device in a regulation in this part is not a precise description of every device that is, or will be, subject to the regulation. A manufacturer who submits a pre-market notification submission for a device under part 807 cannot show merely that the device is accurately described by the section title and identification provision of a regulation in this part but shall state why the device is substantially equivalent to other devices, as required by § 807.87.

(c) To avoid duplicative listings, an ophthalmic device that has two or more types of uses (e.g., used both as a diagnostic device and as a therapeutic device) is listed in one subpart only.

(d) References in this part to regulatory sections of the Code of Federal Regulations are to chapter I of title 21 unless otherwise noted.

(e) Guidance documents referenced in this part are available on the Internet at <http://www.fda.gov/MedicalDevices/>

*DeviceRegulationandGuidance/  
GuidanceDocuments/default.htm..*

[52 FR 33355, Sept. 2, 1987, as amended at 73 FR 34860, June 19, 2008; 78 FR 18233, Mar. 26, 2013]

**§ 886.3 Effective dates of requirement for premarket approval.**

A device included in this part that is classified into class III (premarket approval) shall not be commercially distributed after the date shown in the regulation classifying the device unless the manufacturer has an approval under section 515 of the act (unless an exemption has been granted under section 520(g)(2) of the act). An approval under section 515 of the act consists of FDA's issuance of an order approving an application for premarket approval (PMA) for the device or declaring completed a product development protocol (PDP) for the device.

(a) Before FDA requires that a device commercially distributed before the enactment date of the amendments, or a device that has been found substantially equivalent to such a device, has an approval under section 515 of the act, FDA must promulgate a regulation under section 515(b) of the act requiring such approval, except as provided in paragraphs (b) and (c) of this section. Such a regulation under section 515(b) of the act shall not be effective during the grace period ending on the 90th day after its promulgation or on the last day of the 30th full calendar month after the regulation that classifies the device into class III is effective, whichever is later. See section 501(f)(2)(B) of the act. Accordingly, unless an effective date of the requirement for premarket approval is shown in the regulation for a device classified into class III in this part, the device may be commercially distributed without FDA's issuance of an order approving a PMA or declaring completed a PDP for the device. If FDA promulgates a regulation under section 515(b) of the act requiring premarket approval for a device, section 501(f)(1)(A) of the act applies to the device.

(b) Any new, not substantially equivalent, device introduced into commercial distribution on or after May 28, 1976, including a device formerly marketed that has been substantially al-

tered, is classified by statute (section 513(f) of the act) into class III without any grace period and FDA must have issued an order approving a PMA or declaring completed a PDP for the device before the device is commercially distributed unless it is reclassified. If FDA knows that a device being commercially distributed may be a "new" device as defined in this section because of any new intended use or other reasons, FDA may codify the statutory classification of the device into class III for such new use. Accordingly, the regulation for such a class III device states that as of the enactment date of the amendments, May 28, 1976, the device must have an approval under section 515 of the act before commercial distribution.

(c) A device identified in a regulation in this part that is classified into class III and that is subject to the transitional provisions of section 520(1) of the act is automatically classified by statute into class III and must have an approval under section 515 of the act before being commercially distributed. Accordingly, the regulation for such a class III transitional device states that as of the enactment date of the amendments, May 28, 1976, the device must have an approval under section 515 of the act before commercial distribution.

**§ 886.9 Limitations of exemptions from section 510(k) of the Federal Food, Drug, and Cosmetic Act (the act).**

The exemption from the requirement of premarket notification (section 510(k) of the act) for a generic type of class I or II device is only to the extent that the device has existing or reasonably foreseeable characteristics of commercially distributed devices within that generic type or, in the case of in vitro diagnostic devices, only to the extent that misdiagnosis as a result of using the device would not be associated with high morbidity or mortality. Accordingly, manufacturers of any commercially distributed class I or II device for which FDA has granted an exemption from the requirement of premarket notification must still submit a premarket notification to FDA before introducing or delivering for introduction into interstate commerce

**§ 886.1040**

for commercial distribution the device when:

(a) The device is intended for a use different from the intended use of a legally marketed device in that generic type of device; e.g., the device is intended for a different medical purpose, or the device is intended for lay use where the former intended use was by health care professionals only;

(b) The modified device operates using a different fundamental scientific technology than a legally marketed device in that generic type of device; e.g., a surgical instrument cuts tissue with a laser beam rather than with a sharpened metal blade, or an in vitro diagnostic device detects or identifies infectious agents by using deoxyribonucleic acid (DNA) probe or nucleic acid hybridization technology rather than culture or immunoassay technology; or

(c) The device is an in vitro device that is intended:

(1) For use in the diagnosis, monitoring, or screening of neoplastic diseases with the exception of immunohistochemical devices;

(2) For use in screening or diagnosis of familial or acquired genetic disorders, including inborn errors of metabolism;

(3) For measuring an analyte that serves as a surrogate marker for screening, diagnosis, or monitoring life-threatening diseases such as acquired immune deficiency syndrome (AIDS), chronic or active hepatitis, tuberculosis, or myocardial infarction or to monitor therapy;

(4) For assessing the risk of cardiovascular diseases;

(5) For use in diabetes management;

(6) For identifying or inferring the identity of a microorganism directly from clinical material;

(7) For detection of antibodies to microorganisms other than immunoglobulin G (IgG) or IgG assays when the results are not qualitative, or are used to determine immunity, or the assay is intended for use in matrices other than serum or plasma;

(8) For noninvasive testing as defined in § 812.3(k) of this chapter; and

(9) For near patient testing (point of care).

[65 FR 2320, Jan. 14, 2000]

**Subpart B—Diagnostic Devices**

**§ 886.1040 Ocular esthesiometer.**

(a) *Identification.* An ocular esthesiometer is a device, such as a single-hair brush, intended to touch the cornea to assess corneal sensitivity.

(b) *Classification.* Class I (general controls). The device is exempt from the premarket notification procedures in subpart E of part 807 of this chapter, subject to the limitations in § 886.9.

[52 FR 33355, Sept. 2, 1987, as amended at 53 FR 35603, Sept. 14, 1988; 59 FR 63012, Dec. 7, 1994; 66 FR 38809, July 25, 2001]

**§ 886.1050 Adaptometer (biophotometer).**

(a) *Identification.* An adaptometer (biophotometer) is an AC-powered device that provides a stimulating light source which has various controlled intensities intended to measure the time required for retinal adaptation (regeneration of the visual purple) and the minimum light threshold.

(b) *Classification.* Class I (general controls). The device is exempt from the premarket notification procedures in subpart E of part 807 of this chapter, subject to the limitations in § 886.9.

[55 FR 48441, Nov. 20, 1990, as amended at 59 FR 63012, Dec. 7, 1994; 66 FR 38809, July 25, 2001]

**§ 886.1070 Anomaloscope.**

(a) *Identification.* An anomaloscope is an AC-powered device intended to test for anomalies of color vision by displaying mixed spectral lines to be matched by the patient.

(b) *Classification.* Class I (general controls). The device is exempt from the premarket notification procedures in subpart E of part 807 of this chapter, subject to the limitations in § 886.9.

[55 FR 48441, Nov. 20, 1990, as amended at 59 FR 63012, Dec. 7, 1994; 66 FR 38810, July 25, 2001]

**§ 886.1090 Haidinger brush.**

(a) *Identification.* A Haidinger brush is an AC-powered device that provides two conical brushlike images with apexes touching which are viewed by the patient through a Nicol prism and intended to evaluate visual function. It

may include a component for measuring macular integrity.

(b) *Classification.* Class I (general controls). The device is exempt from the premarket notification procedures in subpart E of part 807 of this chapter, subject to the limitations in § 886.9.

[55 FR 48441, Nov. 20, 1990, as amended at 59 FR 63012, Dec. 7, 1994; 66 FR 38810, July 25, 2001; 72 FR 17400, Apr. 9, 2007]

#### § 886.1120 Ophthalmic camera.

(a) *Identification.* An ophthalmic camera is an AC-powered device intended to take photographs of the eye and the surrounding area.

(b) *Classification.* Class II (special controls). The device, when it is a photorefractor or a general-use ophthalmic camera, is exempt from the premarket notification procedures in subpart E of part 807 of this chapter subject to the limitations in § 886.9.

[55 FR 48441, Nov. 20, 1990, as amended at 84 FR 71817, Dec. 30, 2019]

#### § 886.1140 Ophthalmic chair.

(a) *Identification.* An ophthalmic chair is an AC-powered or manual device with adjustable positioning in which a patient is to sit or recline during ophthalmological examination or treatment.

(b) *Classification.* Class I. The AC-powered device and the manual device are exempt from the premarket notification procedures in subpart E of part 807 of this chapter, subject to the limitations in § 886.9. The manual device is also exempt from the current good manufacturing practice requirements of the quality system regulation in part 820 of this chapter, with the exception of § 820.180, with respect to general requirements concerning records, and § 820.198, with respect to complaint files.

[55 FR 48441, Nov. 20, 1990, as amended at 59 FR 63012, Dec. 7, 1994; 66 FR 38810, July 25, 2001]

#### § 886.1150 Visual acuity chart.

(a) *Identification.* A visual acuity chart is a device that is a chart, such as a Snellen chart with block letters or other symbols in graduated sizes, intended to test visual acuity.

(b) *Classification.* Class I (general controls). The device is exempt from the premarket notification procedures in subpart E of part 807 of this chapter, subject to the limitations in § 886.9. The device is also exempt from the current good manufacturing practice requirements of the quality system regulation in part 820 of this chapter, with the exception of § 820.180, with respect to general requirements concerning records, and § 820.198, with respect to complaint files.

[52 FR 33355, Sept. 2, 1987, as amended at 53 FR 35603, Sept. 14, 1988; 53 FR 40825, Oct. 18, 1988; 66 FR 38810, July 25, 2001]

#### § 886.1160 Color vision plate illuminator.

(a) *Identification.* A color vision plate illuminator is an AC-powered device that is a lamp intended to properly illuminate color vision testing plates. It may include a filter.

(b) *Classification.* Class I (general controls). The device is exempt from the premarket notification procedures in subpart E of part 807 of this chapter, subject to the limitations in § 886.9.

[55 FR 48441, Nov. 20, 1990, as amended at 59 FR 63012, Dec. 7, 1994; 66 FR 38810, July 25, 2001]

#### § 886.1170 Color vision tester.

(a) *Identification.* A color vision tester is a device that consists of various colored materials, such as colored yarns or color vision plates (multicolored plates which patients with color vision deficiency would perceive as being of one color), intended to evaluate color vision.

(b) *Classification.* Class I (general controls). The device is exempt from the premarket notification procedures in subpart E of part 807 of this chapter, subject to the limitations in § 886.9. The device is also exempt from the current good manufacturing practice requirements of the quality system regulation in part 820 of this chapter, with the exception of § 820.180, with respect to general requirements concerning records, and § 820.198, with respect to complaint files.

[52 FR 33355, Sept. 2, 1987, as amended at 53 FR 35603, Sept. 14, 1988; 66 FR 38810, July 25, 2001]

## § 886.1190

## 21 CFR Ch. I (4–1–20 Edition)

### § 886.1190 Distometer.

(a) *Identification.* A distometer is a device intended to measure the distance between the cornea and a corrective lens during refraction to help measure the change of the visual image when a lens is in place.

(b) *Classification.* Class I (general controls). The device is exempt from the premarket notification procedures in subpart E of part 807 of this chapter, subject to the limitations in § 886.9. The device is also exempt from the current good manufacturing practice requirements of the quality system regulation in part 820 of this chapter, with the exception of § 820.180, with respect to general requirements concerning records, and § 820.198, with respect to complaint files.

[52 FR 33355, Sept. 2, 1987, as amended at 53 FR 35603, Sept. 14, 1988; 66 FR 38810, July 25, 2001]

### § 886.1200 Optokinetic drum.

(a) *Identification.* An optokinetic drum is a drum-like device covered with alternating white and dark stripes or pictures that can be rotated on its handle. The device is intended to elicit and evaluate nystagmus (involuntary rapid movement of the eyeball) in patients.

(b) *Classification.* Class I (general controls). The device is exempt from the premarket notification procedures in subpart E of part 807 of this chapter, subject to the limitations in § 886.9. The device is also exempt from the current good manufacturing practice requirements of the quality system regulation in part 820 of this chapter, with the exception of § 820.180, with respect to general requirements concerning records, and § 820.198, with respect to complaint files.

[52 FR 33355, Sept. 2, 1987, as amended at 53 FR 35604, Sept. 14, 1988; 66 FR 38810, July 25, 2001]

### § 886.1220 Corneal electrode.

(a) *Identification.* A corneal electrode is an AC-powered device, usually part of a special contact lens, intended to be applied directly to the cornea to provide data showing the changes in electrical potential in the retina after

electroretinography (stimulation by light).

(b) *Classification.* Class II.

### § 886.1250 Euthyscope.

(a) *Identification.* A euthyscope is a device that is a modified AC-powered or battery-powered ophthalmoscope (a perforated mirror device intended to inspect the interior of the eye) that projects a bright light encompassing an arc of about 30 degrees onto the fundus of the eye. The center of the light bundle is blocked by a black disk covering the fovea (the central depression of the macular retinae where only cones are present and blood vessels are lacking). The device is intended for use in the treatment of amblyopia (dimness of vision without apparent disease of the eye).

(b) *Classification.* (1) Class I (general controls) for the battery-powered device. The battery-powered device is exempt from the premarket notification procedures in subpart E of part 807 of this chapter subject to the limitations in § 886.9.

(2) Class II (special controls) for the AC-powered device. The AC-powered device is exempt from the premarket notification procedures in subpart E of part 807 of this chapter subject to the limitations in § 886.9.

[55 FR 48441, Nov. 20, 1990, as amended at 59 FR 63012, Dec. 7, 1994; 66 FR 38810, July 25, 2001; 84 FR 71817, Dec. 30, 2019]

### § 886.1270 Exophthalmometer.

(a) *Identification.* An exophthalmometer is a device, such as a ruler, gauge, or caliper, intended to measure the degree of exophthalmos (abnormal protrusion of the eyeball).

(b) *Classification.* Class I (general controls). The device is exempt from the premarket notification procedures in subpart E of part 807 of this chapter, subject to the limitations in § 886.9.

[52 FR 33355, Sept. 2, 1987, as amended at 53 FR 35604, Sept. 14, 1988; 66 FR 38810, July 25, 2001]

### § 886.1290 Fixation device.

(a) *Identification.* A fixation device is an AC-powered device intended for use as a fixation target for the patient during ophthalmological examination. The



patient directs his or her gaze so that the visual image of the object falls on the fovea centralis (the center of the macular retina of the eye.)

(b) *Classification*. Class I (general controls). The device is exempt from the premarket notification procedures in subpart E of part 807 of this chapter, subject to the limitations in § 886.9.

[55 FR 48441, Nov. 20, 1990, as amended at 59 FR 63012, Dec. 7, 1994; 66 FR 38810, July 25, 2001]

#### § 886.1300 Afterimage flasher.

(a) *Identification*. An afterimage flasher is an AC-powered light that automatically switches on and off to allow performance of an afterimage test in which the patient indicates the positions of afterimages after the light is off. The device is intended to determine harmonious/anomalous retinal correspondence (the condition in which corresponding points on the retina have the same directional value).

(b) *Classification*. Class II.

[55 FR 48441, Nov. 20, 1990]

#### § 886.1320 Fornixscope.

(a) *Identification*. A fornixscope is a device intended to pull back and hold open the eyelid to aid examination of the conjunctiva.

(b) *Classification*. Class I (general controls). The device is exempt from the premarket notification procedures in subpart E of part 807 of this chapter, subject to the limitations in § 886.9. The device is also exempt from the current good manufacturing practice requirements of the quality system regulation in part 820 of this chapter, with the exception of § 820.180, with respect to general requirements concerning records, and § 820.198, with respect to complaint files.

[52 FR 33355, Sept. 2, 1987, as amended at 53 FR 35604, Sept. 14, 1988; 66 FR 38810, July 25, 2001]

#### § 886.1330 Amsler grid.

(a) *Identification*. An Amsler grid is a device that is a series of charts with grids of different sizes that are held at 30 centimeters distance from the patient and intended to rapidly detect central and paracentral irregularities in the visual field.

(b) *Classification*. Class I (general controls). The device is exempt from the premarket notification procedures in subpart E of part 807 of this chapter, subject to the limitations in § 886.9. The device is also exempt from the current good manufacturing practice requirements of the quality system regulation in part 820 of this chapter, with the exception of § 820.180, with respect to general requirements concerning records, and § 820.198, with respect to complaint files.

[52 FR 33355, Sept. 2, 1987, as amended at 53 FR 35604, Sept. 14, 1988; 66 FR 38810, July 25, 2001]

#### § 886.1340 Haploscope.

(a) *Identification*. A haploscope is an AC-powered device that consists of two movable viewing tubes, each containing a slide carrier, a low-intensity light source for the illumination of the slides, and a high-intensity light source for creating afterimages. The device is intended to measure strabismus (eye muscle imbalance), to assess binocular vision (use of both eyes to see), and to treat suppression and amblyopia (dimness of vision without any apparent disease of the eye).

(b) *Classification*. Class I (general controls). The device is exempt from the premarket notification procedures in subpart E of part 807 of this chapter, subject to the limitations in § 886.9.

[55 FR 48441, Nov. 20, 1990, as amended at 59 FR 63012, Dec. 7, 1994; 66 FR 38810, July 25, 2001]

#### § 886.1342 Strabismus detection device.

(a) *Identification*. A strabismus detection device is a prescription device designed to simultaneously illuminate both eyes with polarized light for automated detection of strabismus by analyzing foveal birefringence properties.

(b) *Classification*. Class II (special controls). The special controls for this device are:

(1) Clinical performance testing must demonstrate the device performs as intended under anticipated conditions of use. Testing must be conducted in a representative patient population and clinical setting for the indicated use. Demonstration of clinical performance must include assessment of sensitivity

## § 886.1350

and specificity compared to a clearly defined reference standard (e.g., comprehensive ophthalmological examination comprises age-appropriate visual acuity testing, examination of the external ocular adnexae and orbit, anterior segment evaluation, extraocular motility evaluation, assessment of stereopsis, cycloplegic refraction, and dilated fundus examination).

(2) Non-clinical performance testing must demonstrate the device performs as intended under anticipated conditions of use. The following technical characteristics must be evaluated:

(i) Verification of lowest detectable amount of deviation; and

(ii) Validation of the accuracy and precision at the lowest detectable amount of deviation.

(3) Software verification, validation, and hazard analysis must be performed.

(4) Optical radiation safety testing must demonstrate the device is safe per the directions for use.

(5) Performance testing must demonstrate the electromagnetic compatibility of the device.

(6) Performance testing must demonstrate the electrical safety of the device.

(7) Labeling must include the following:

(i) Summaries of non-clinical and clinical performance testing;

(ii) Instructions on how to correctly use and maintain the device;

(iii) Instructions and explanation of all user-interface components; and

(iv) Information related to electromagnetic compatibility and optical radiation classification.

[81 FR 65280, Sept. 22, 2016]

## § 886.1350 Keratoscope.

(a) *Identification.* A keratoscope is an AC-powered or battery-powered device intended to measure and evaluate the corneal curvature of the eye. Lines and circles within the keratoscope are used to observe the corneal reflex. This generic type of device includes the photokeratoscope which records corneal curvature by taking photographs of the cornea.

(b) The device is exempt from the premarket notification procedures in subpart E of part 807 of this chapter subject to § 886.9. The battery-powered

## 21 CFR Ch. I (4–1–20 Edition)

device is exempt from the current good manufacturing practice requirements of the quality system regulation in part 820 of this chapter, with the exception of § 820.180 of this chapter, with respect to general requirements concerning records, and § 820.198 of this chapter, with respect to complaint files

[55 FR 48441, Nov. 20, 1990, as amended at 59 FR 63012, Dec. 7, 1994; 65 FR 2320, Jan. 14, 2000]

## § 886.1360 Visual field laser instrument.

(a) *Identification.* A visual field laser instrument is an AC-powered device intended to provide visible laser radiation that produces an interference pattern on the retina to evaluate retinal function.

(b) *Classification.* Class II.

## § 886.1375 Bagolini lens.

(a) *Identification.* A Bagolini lens is a device that consists of a plane lens containing almost imperceptible striations that do not obscure visualization of objects. The device is placed in a trial frame and intended to determine harmonious/anomalous retinal correspondence (a condition in which corresponding points on the retina have the same directional values).

(b) *Classification.* Class I (general controls). The device is exempt from the premarket notification procedures in subpart E of part 807 of this chapter, subject to the limitations in § 886.9. The device is also exempt from the current good manufacturing practice requirements of the quality system regulation in part 820 of this chapter, with the exception of § 820.180, with respect to general requirements concerning records, and § 820.198, with respect to complaint files.

[52 FR 33355, Sept. 2, 1987, as amended at 53 FR 35604, Sept. 14, 1988; 66 FR 38810, July 25, 2001]

## § 886.1380 Diagnostic condensing lens.

(a) *Identification.* A diagnostic condensing lens is a device used in binocular indirect ophthalmoscopy (a procedure that produces an inverted or reversed direct magnified image of the eye) intended to focus reflected light from the fundus of the eye.

(b) *Classification*. Class I (general controls). The device is exempt from the premarket notification procedures in subpart E of part 807 of this chapter, subject to the limitations in § 886.9. The device is also exempt from the current good manufacturing practice requirements of the quality system regulation in part 820 of this chapter, with the exception of § 820.180, with respect to general requirements concerning records, and § 820.198, with respect to complaint files.

[52 FR 33355, Sept. 2, 1987, as amended at 53 FR 35604, Sept. 14, 1988; 66 FR 38810, July 25, 2001]

**§ 886.1385 Polymethylmethacrylate (PMMA) diagnostic contact lens.**

(a) *Identification*. A polymethylmethacrylate (PMMA) diagnostic contact lens is a device that is a curved shell of PMMA intended to be applied for a short period of time directly on the globe or cornea of the eye for diagnosis or therapy of intraocular abnormalities.

(b) *Classification*. Class II.

**§ 886.1390 Flexible diagnostic Fresnel lens.**

(a) *Identification*. A flexible diagnostic Fresnel lens is a device that is a very thin lens which has its surface a concentric series of increasingly refractive zones. The device is intended to be applied to the back of the spectacle lenses of patients with aphakia (absence of the lens of the eye).

(b) *Classification*. Class I (general controls). The device is exempt from the premarket notification procedures in subpart E of part 807 of this chapter, subject to the limitations in § 886.9. The device is also exempt from the current good manufacturing practice requirements of the quality system regulation in part 820 of this chapter, with the exception of § 820.180, with respect to general requirements concerning records, and § 820.198, with respect to complaint files.

[52 FR 33355, Sept. 2, 1987, as amended at 53 FR 35604, Sept. 14, 1988; 66 FR 38811, July 25, 2001]

**§ 886.1395 Diagnostic Hruby fundus lens.**

(a) *Identification*. A diagnostic Hruby fundus lens is a device that is a 55 diopter lens intended for use in the examination of the vitreous body and the fundus of the eye under slitlamp illumination and magnification.

(b) *Classification*. Class I (general controls). The device is exempt from the premarket notification procedures in subpart E of part 807 of this chapter, subject to the limitations in § 886.9. The device is also exempt from the current good manufacturing practice requirements of the quality system regulation in part 820 of this chapter, with the exception of § 820.180, with respect to general requirements concerning records, and § 820.198, with respect to complaint files.

[52 FR 33355, Sept. 2, 1987, as amended at 53 FR 35604, Sept. 14, 1988; 66 FR 38811, July 25, 2001]

**§ 886.1400 Maddox lens.**

(a) *Identification*. A Maddox lens is a device that is a series of red cylinders that change the size, shape, and color of an image. The device is intended to be handheld or placed in a trial frame to evaluate eye muscle dysfunction.

(b) *Classification*. Class I (general controls). The device is exempt from the premarket notification procedures in subpart E of part 807 of this chapter, subject to the limitations in § 886.9. The device is also exempt from the current good manufacturing practice requirements of the quality system regulation in part 820 of this chapter, with the exception of § 820.180, with respect to general requirements concerning records, and § 820.198, with respect to complaint files.

[52 FR 33355, Sept. 2, 1987, as amended at 53 FR 35604, Sept. 14, 1988; 66 FR 38811, July 25, 2001]

**§ 886.1405 Ophthalmic trial lens set.**

(a) *Identification*. An ophthalmic trial lens set is a device that is a set of lenses of various dioptric powers intended to be handheld or inserted in a trial frame for vision testing to determine refraction.

(b) *Classification*. Class I (general controls). The device is exempt from the

## § 886.1410

premarket notification procedures in subpart E of part 807 of this chapter, subject to the limitations in § 886.9.

[52 FR 33355, Sept. 2, 1987, as amended at 61 FR 1124, Jan. 16, 1996; 66 FR 38811, July 25, 2001]

### § 886.1410 Ophthalmic trial lens clip.

(a) *Identification.* An ophthalmic trial lens clip is a device intended to hold prisms, spheres, cylinders, or occluders on a trial frame or spectacles for vision testing.

(b) *Classification.* Class I (general controls). The device is exempt from the premarket notification procedures in subpart E of part 807 of this chapter, subject to the limitations in § 886.9.

[52 FR 33355, Sept. 2, 1987, as amended at 53 FR 35604, Sept. 14, 1988; 66 FR 38811, July 25, 2001]

### § 886.1415 Ophthalmic trial lens frame.

(a) *Identification.* An ophthalmic trial lens frame is a mechanical device intended to hold trial lenses for vision testing.

(b) *Classification.* Class I (general controls). The device is exempt from the premarket notification procedures in subpart E of part 807 of this chapter, subject to the limitations in § 886.9. The device is also exempt from the current good manufacturing practice requirements of the quality system regulation in part 820 of this chapter, with the exception of § 820.180, with respect to general requirements concerning records, and § 820.198, with respect to complaint files.

[52 FR 33355, Sept. 2, 1987, as amended at 53 FR 35604, Sept. 14, 1988; 66 FR 38811, July 25, 2001]

### § 886.1420 Ophthalmic lens gauge.

(a) *Identification.* An ophthalmic lens gauge is a calibrated device intended to manually measure the curvature of a spectacle lens.

(b) *Classification.* Class I (general controls). The device is exempt from the premarket notification procedures in subpart E of part 807 of this chapter, subject to the limitations in § 886.9.

[52 FR 33355, Sept. 2, 1987, as amended at 53 FR 35604, Sept. 14, 1988; 66 FR 38811, July 25, 2001]

## 21 CFR Ch. I (4–1–20 Edition)

### § 886.1425 Lens measuring instrument.

(a) *Identification.* A lens measuring instrument is an AC-powered device intended to measure the power of lenses, prisms, and their centers (e.g., lensometer).

(b) *Classification.* Class I (general controls). The device is exempt from the premarket notification procedures in subpart E of part 807 of this chapter, subject to the limitations in § 886.9.

[55 FR 48442, Nov. 20, 1990, as amended at 59 FR 63013, Dec. 7, 1994; 66 FR 38811, July 25, 2001]

### § 886.1430 Ophthalmic contact lens radius measuring device.

(a) *Identification.* An ophthalmic contact lens radius measuring device is an AC-powered device that is a microscope and dial gauge intended to measure the radius of a contact lens.

(b) *Classification.* Class I (general controls). The device is exempt from the premarket notification procedures in subpart E of part 807 of this chapter, subject to the limitations in § 886.9.

[55 FR 48442, Nov. 20, 1990, as amended at 59 FR 63013, Dec. 7, 1994; 66 FR 38811, July 25, 2001]

### § 886.1435 Maxwell spot.

(a) *Identification.* A Maxwell spot is an AC-powered device that is a light source with a red and blue filter intended to test macular function.

(b) *Classification.* Class I (general controls). The device is exempt from the premarket notification procedures in subpart E of part 807 of this chapter, subject to the limitations in § 886.9.

[55 FR 48442, Nov. 20, 1990, as amended at 59 FR 63013, Dec. 7, 1994; 66 FR 38811, July 25, 2001]

### § 886.1450 Corneal radius measuring device.

(a) *Identification.* A corneal radius measuring device is an AC-powered device intended to measure corneal size by superimposing the image of the cornea on a scale at the focal length of the lens of a small, hand held, single tube penscope or eye gauge magnifier.

(b) *Classification.* Class I (general controls). The device is exempt from the premarket notification procedures in subpart E of part 807 of this chapter,

## Food and Drug Administration, HHS

## § 886.1630

subject to the limitations in § 886.9, only when the device does not include computer software in the unit or topographers.

[55 FR 48442, Nov. 20, 1990, as amended at 59 FR 63013, Dec. 7, 1994; 66 FR 38811, July 25, 2001]

### § 886.1460 Stereopsis measuring instrument.

(a) *Identification.* A stereopsis measuring instrument is a device intended to measure depth perception by illumination of objects placed on different planes.

(b) *Classification.* Class I (general controls). The device is exempt from the premarket notification procedures in subpart E of part 807 of this chapter, subject to the limitations in § 886.9. The device is also exempt from the current good manufacturing practice requirements of the quality system regulation in part 820 of this chapter, with the exception of § 820.180, with respect to general requirements concerning records, and § 820.198, with respect to complaint files.

[52 FR 33355, Sept. 2, 1987, as amended at 53 FR 35605, Sept. 14, 1988; 66 FR 38811, July 25, 2001]

### § 886.1500 Headband mirror.

(a) *Identification.* A headband mirror is a device intended to be strapped to the head of the user to reflect light for use in examination of the eye.

(b) *Classification.* Class I (general controls). The device is exempt from the premarket notification procedures in subpart E of part 807 of this chapter, subject to the limitations in § 886.9. The device is also exempt from the current good manufacturing practice requirements of the quality system regulation in part 820 of this chapter, with the exception of § 820.180, with respect to general requirements concerning records, and § 820.198, with respect to complaint files.

[52 FR 33355, Sept. 2, 1987, as amended at 53 FR 35605, Sept. 14, 1988; 66 FR 38811, July 25, 2001]

### § 886.1510 Eye movement monitor.

(a) *Identification.* An eye movement monitor is an AC-powered device with

an electrode intended to measure and record ocular movements.

(b) *Classification.* Class II.

### § 886.1570 Ophthalmoscope.

(a) *Identification.* An ophthalmoscope is an AC-powered or battery-powered device containing illumination and viewing optics intended to examine the media (cornea, aqueous, lens, and vitreous) and the retina of the eye.

(b) *Classification.* Class II (special controls). The device, when it is an AC-powered ophthalmoscope, a battery-powered ophthalmoscope, or a hand-held ophthalmoscope replacement battery, is exempt from the premarket notification procedures in subpart E of part 807 of this chapter subject to the limitations in § 886.9.

[52 FR 33355, Sept. 2, 1987, as amended at 84 FR 71817, Dec. 30, 2019]

### § 886.1605 Perimeter.

(a) *Identification.* A perimeter is an AC-powered or manual device intended to determine the extent of the peripheral visual field of a patient. The device projects light on various points of a curved surface, and the patient indicates whether he or she sees the light.

(b) *Classification.* Class I (general controls). The device is exempt from the premarket notification procedures in subpart E of part 807 of this chapter, subject to the limitations in § 886.9. The device is also exempt from the current good manufacturing practice requirements of the quality system regulation in part 820 of this chapter, with the exception of § 820.180, with respect to general requirements concerning records, and § 820.198, with respect to complaint files.

[55 FR 48442, Nov. 20, 1990, as amended at 66 FR 38811, July 25, 2001]

### § 886.1630 AC-powered photostimulator.

(a) *Identification.* An AC-powered photostimulator is an AC-powered device intended to provide light stimulus which allows measurement of retinal or visual function by perceptual or electrical methods (e.g., stroboscope).

(b) *Classification.* Class II.

## § 886.1640

## 21 CFR Ch. I (4–1–20 Edition)

### § 886.1640 Ophthalmic preamplifier.

(a) *Identification.* An ophthalmic preamplifier is an AC-powered or battery-powered device intended to amplify electrical signals from the eye in electroretinography (recording retinal action currents from the surface of the eyeball after stimulation by light), electrooculography (testing for retinal dysfunction by comparing the standing potential in the front and the back of the eyeball), and electromyography (recording electrical currents generated in active muscle).

(b) *Classification.* Class II.

### § 886.1650 Ophthalmic bar prism.

(a) *Identification.* An ophthalmic bar prism is a device that is a bar composed of fused prisms of gradually increasing strengths intended to measure latent and manifest strabismus (eye muscle deviation) or the power of fusion of a patient's eyes.

(b) *Classification.* Class I (general controls). The device is exempt from the premarket notification procedures in subpart E of part 807 of this chapter, subject to the limitations in § 886.9. The device is also exempt from the current good manufacturing practice requirements of the quality system regulation in part 820 of this chapter, with the exception of § 820.180, with respect to general requirements concerning records, and § 820.198, with respect to complaint files.

[52 FR 33355, Sept. 2, 1987, as amended at 53 FR 35605, Sept. 14, 1988; 66 FR 38812, July 25, 2001]

### § 886.1655 Ophthalmic Fresnel prism.

(a) *Identification.* An ophthalmic Fresnel prism is a device that is a thin plastic sheet with embossed rulings which provides the optical effect of a prism. The device is intended to be applied to spectacle lenses to give a prismatic effect.

(b) *Classification.* Class I (general controls). The device is exempt from the premarket notification procedures in subpart E of part 807 of this chapter, subject to the limitations in § 886.9. The device is also exempt from the current good manufacturing practice requirements of the quality system regulation in part 820 of this chapter, with the ex-

ception of § 820.180, with respect to general requirements concerning records, and § 820.198, with respect to complaint files.

[52 FR 33355, Sept. 2, 1987, as amended at 53 FR 35605, Sept. 14, 1988; 66 FR 38812, July 25, 2001]

### § 886.1660 Gonioscopic prism.

(a) *Identification.* A gonioscopic prism is a device that is a prism intended to be placed on the eye to study the anterior chamber. The device may have angled mirrors to facilitate visualization of anatomical features.

(b) *Classification.* Class I (general controls). The device is exempt from the premarket notification procedures in subpart E of part 807 of this chapter, subject to the limitations in § 886.9.

[52 FR 33355, Sept. 2, 1987, as amended at 53 FR 35605, Sept. 14, 1988; 59 FR 63013, Dec. 7, 1994; 66 FR 38812, July 25, 2001]

### § 886.1665 Ophthalmic rotary prism.

(a) *Identification.* An ophthalmic rotary prism is a device with various prismatic powers intended to be handheld and used to measure ocular deviation in patients with latent or manifest strabismus (eye muscle deviation).

(b) *Classification.* Class I (general controls). The device is exempt from the premarket notification procedures in subpart E of part 807 of this chapter, subject to the limitations in § 886.9. The device is also exempt from the current good manufacturing practice requirements of the quality system regulation in part 820 of this chapter, with the exception of § 820.180, with respect to general requirements concerning records, and § 820.198, with respect to complaint files.

[52 FR 33355, Sept. 2, 1987, as amended at 53 FR 35605, Sept. 14, 1988; 66 FR 38812, July 25, 2001]

### § 886.1670 Ophthalmic isotope uptake probe.

(a) *Identification.* An ophthalmic isotope uptake probe is an AC-powered device intended to measure, by a probe which is placed in close proximity to the eye, the uptake of a radioisotope (phosphorus 32) by tumors to detect

tumor masses on, around, or within the eye.

(b) *Classification*. Class II.

**§ 886.1680 Ophthalmic projector.**

(a) *Identification*. An ophthalmic projector is an AC-powered device intended to project an image on a screen for vision testing.

(b) *Classification*. Class I (general controls). The device is exempt from the premarket notification procedures in subpart E of part 807 of this chapter, subject to the limitations in § 886.9.

[55 FR 48442, Nov. 20, 1990, as amended at 59 FR 63013, Dec. 7, 1994; 66 FR 38812, July 25, 2001]

**§ 886.1690 Pupillograph.**

(a) *Identification*. A pupillograph is an AC-powered device intended to measure the pupil of the eye by reflected light and record the responses of the pupil.

(b) *Classification*. Class I (general controls). The device is exempt from the premarket notification procedures in subpart E of part 807 of this chapter, subject to the limitations in § 886.9.

[55 FR 48442, Nov. 20, 1990, as amended at 59 FR 63013, Dec. 7, 1994; 66 FR 38812, July 25, 2001]

**§ 886.1700 Pupillometer.**

(a) *Identification*. A pupillometer is an AC-powered or manual device intended to measure by reflected light the width or diameter of the pupil of the eye.

(b) *Classification*. Class I (general controls). The AC-powered device and the manual device are exempt from the premarket notification procedures in subpart E of part 807 of this chapter, subject to the limitations in § 886.9. The manual device is also exempt from the current good manufacturing practice requirements of the quality system regulation in part 820 of this chapter, with the exception of § 820.180, with respect to general requirements concerning records, and § 820.198, with respect to complaint files.

[55 FR 48442, Nov. 20, 1990, as amended at 59 FR 63013, Dec. 7, 1994; 66 FR 38812, July 25, 2001]

**§ 886.1750 Skiascopic rack.**

(a) *Identification*. A skiascopic rack is a device that is a rack and a set of attached ophthalmic lenses of various dioptric strengths intended as an aid in refraction.

(b) *Classification*. Class I (general controls). The device is exempt from the premarket notification procedures in subpart E of part 807 of this chapter, subject to the limitations in § 886.9.

[52 FR 33355, Sept. 2, 1987, as amended at 61 FR 1124, Jan. 16, 1996; 66 FR 38812, July 25, 2001]

**§ 886.1760 Ophthalmic refractometer.**

(a) *Identification*. An ophthalmic refractometer is an automatic AC-powered device that consists of a fixation system, a measurement and recording system, and an alignment system intended to measure the refractive power of the eye by measuring light reflexes from the retina.

(b) *Classification*. Class I (general controls). The device is exempt from the premarket notification procedures in subpart E of part 807 of this chapter, subject to the limitations in § 886.9.

[52 FR 33355, Sept. 2, 1987, as amended at 61 FR 1124, Jan. 16, 1996; 66 FR 38812, July 25, 2001]

**§ 886.1770 Manual refractor.**

(a) *Identification*. A manual refractor is a device that is a set of lenses of various dioptric powers intended to measure the refractive error of the eye.

(b) *Classification*. Class I (general controls). The device is exempt from the premarket notification procedures in subpart E of part 807 of this chapter, subject to the limitations in § 886.9. The device is also exempt from the current good manufacturing practice requirements of the quality system regulation in part 820 of this chapter, with the exception of § 820.180, with respect to general requirements concerning records, and § 820.198, with respect to complaint files.

[52 FR 33355, Sept. 2, 1987, as amended at 53 FR 35605, Sept. 14, 1988; 66 FR 38812, July 25, 2001]

**§ 886.1780 Retinoscope.**

(a) *Identification*. A retinoscope is an AC-powered or battery-powered device

## § 886.1790

intended to measure the refraction of the eye by illuminating the retina and noting the direction of movement of the light on the retinal surface and of the refraction by the eye of the emergent rays.

(b) *Classification.* (1) Class II (special controls) for the AC-powered device. The device is exempt from the premarket notification procedures in subpart E of part 807 of this chapter subject to the limitations in § 886.9.

(2) Class I (general controls) for the battery-powered device. The class I battery-powered device is exempt from the premarket notification procedures in subpart E of part 807 of this chapter subject to § 886.9. The battery-powered device is exempt from the current good manufacturing practice requirements of the quality system regulation in part 820 of this chapter, with the exception of § 820.180 of this chapter, with respect to general requirements concerning records, and § 820.198 of this chapter, with respect to complaint files.

[55 FR 48442, Nov. 20, 1990; 55 FR 51799, Dec. 17, 1990, as amended at 65 FR 2320, Jan. 14, 2000; 84 FR 71817, Dec. 30, 2019]

## § 886.1790 Nearpoint ruler.

(a) *Identification.* A nearpoint ruler is a device calibrated in centimeters intended to measure the nearpoint of convergence (the point to which the visual lines are directed when convergence is at its maximum).

(b) *Classification.* Class I (general controls). The device is exempt from the premarket notification procedures in subpart E of part 807 of this chapter, subject to the limitations in § 886.9. The device is also exempt from the current good manufacturing practice requirements of the quality system regulation in part 820 of this chapter, with the exception of § 820.180, with respect to general requirements concerning records, and § 820.198, with respect to complaint files.

[52 FR 33355, Sept. 2, 1987, as amended at 53 FR 35605, Sept. 14, 1988; 53 FR 40825, Oct. 18, 1988; 66 FR 38812, July 25, 2001]

## § 886.1800 Schirmer strip.

(a) *Identification.* A Schirmer strip is a device made of filter paper or similar material intended to be inserted under

## 21 CFR Ch. I (4–1–20 Edition)

a patient's lower eyelid to stimulate and evaluate formation of tears.

(b) *Classification.* Class I (general controls). If the device is made of the same materials that were used in the device before May 28, 1976, the device is exempt from the premarket notification procedures in subpart E of part 807 of this chapter, subject to the limitations in § 886.9.

[52 FR 33355, Sept. 2, 1987, as amended at 53 FR 35605, Sept. 14, 1988; 66 FR 38812, July 25, 2001]

## § 886.1810 Tangent screen (campimeter).

(a) *Identification.* A tangent screen (campimeter) is an AC-powered or battery-powered device that is a large square cloth chart with a central mark of fixation intended to map on a flat surface the central 30 degrees of a patient's visual field. This generic type of device includes projection tangent screens, target tangent screens and targets, felt tangent screens, and stereo campimeters.

(b) *Classification.* Class I (general controls). The AC-powered device and the battery-powered device are exempt from the premarket notification procedures in subpart E of part 807 of this chapter, subject to the limitations in § 886.9. The battery-powered device is also exempt from the current good manufacturing practice requirements of the quality system regulation in part 820 of this chapter, with the exception of § 820.180, with respect to general requirements concerning records, and § 820.198, with respect to complaint files.

[55 FR 48442, Nov. 20, 1990, as amended at 59 FR 63013, Dec. 7, 1994; 66 FR 38812, July 25, 2001]

## § 886.1840 Simulatan (including crossed cylinder).

(a) *Identification.* A simulatan (including crossed cylinder) is a device that is a set of pairs of cylinder lenses that provides various equal plus and minus refractive strengths. The lenses are arranged so that the user can exchange the positions of plus and minus cylinder lenses of equal strengths. The device is intended for subjective refraction (refraction in which the patient judges whether a given object is clearly



## Food and Drug Administration, HHS

## § 886.1880

in focus, as the examiner uses different lenses).

(b) *Classification.* Class I (general controls). The device is exempt from the premarket notification procedures in subpart E of part 807 of this chapter, subject to the limitations in § 886.9. The device is also exempt from the current good manufacturing practice requirements of the quality system regulation in part 820 of this chapter, with the exception of § 820.180, with respect to general requirements concerning records, and § 820.198, with respect to complaint files.

[52 FR 33355, Sept. 2, 1987, as amended at 53 FR 35605, Sept. 14, 1988; 66 FR 38812, July 25, 2001]

### § 886.1850 AC-powered slitlamp biomicroscope.

(a) *Identification.* An AC-powered slitlamp biomicroscope is an AC-powered device that is a microscope intended for use in eye examination that projects into a patient's eye through a control diaphragm a thin, intense beam of light.

(b) *Classification.* Class II (special controls). The device, when it is intended only for the visual examination of the anterior segment of the eye, is classified as Group 1 per FDA-recognized consensus standard ANSI Z80.36, does not provide any quantitative output, and is not intended for screening or automated diagnostic indications, is exempt from the premarket notification procedures in subpart E of part 807 of this chapter subject to the limitations in § 886.9.

[52 FR 33355, Sept. 2, 1987, as amended at 84 FR 71817, Dec. 30, 2019]

### § 886.1860 Ophthalmic instrument stand.

(a) *Identification.* An ophthalmic instrument stand is an AC-powered or nonpowered device intended to store ophthalmic instruments in a readily accessible position.

(b) *Classification.* Class I (general controls). The AC-powered device and the battery-powered device are exempt from the premarket notification procedures in subpart E of part 807 of this chapter, subject to the limitations in § 886.9. The battery-powered device is also exempt from the current good

manufacturing practice requirements of the quality system regulation in part 820 of this chapter, with the exception of § 820.180, with respect to general requirements concerning records, and § 820.198, with respect to complaint files.

[55 FR 48442, Nov. 20, 1990, as amended at 59 FR 63013, Dec. 7, 1994; 66 FR 38812, July 25, 2001]

### § 886.1870 Stereoscope.

(a) *Identification.* A stereoscope is an AC-powered or battery-powered device that combines the images of two similar objects to produce a three-dimensional appearance of solidity and relief. It is intended to measure the angle of strabismus (eye muscle deviation), evaluate binocular vision (usage of both eyes to see), and guide a patient's corrective exercises of eye muscles.

(b) *Classification.* Class I (general controls). The AC-powered device and the battery-powered device are exempt from the premarket notification procedures in subpart E of part 807 of this chapter, subject to the limitations in § 886.9. The battery-powered device is also exempt from the current good manufacturing practice requirements of the quality system regulation in part 820 of this chapter, with the exception of § 820.180, with respect to general requirements concerning records, and § 820.198, with respect to complaint files.

[55 FR 48442, Nov. 20, 1990, as amended at 59 FR 63013, Dec. 7, 1994; 66 FR 38813, July 25, 2001]

### § 886.1880 Fusion and stereoscopic target.

(a) *Identification.* A fusion and stereoscopic target is a device intended for use as a viewing object with a stereoscope (§ 886.1870).

(b) *Classification.* Class I (general controls). The device is exempt from the premarket notification procedures in subpart E of part 807 of this chapter, subject to the limitations in § 886.9. The device is also exempt from the current good manufacturing practice requirements of the quality system regulation in part 820 of this chapter, with the exception of § 820.180, with respect to general requirements concerning records,

## § 886.1905

and § 820.198, with respect to complaint files.

[52 FR 33355, Sept. 2, 1987, as amended at 53 FR 35606, Sept. 14, 1988; 66 FR 38813, July 25, 2001]

### § 886.1905 Nystagmus tape.

(a) *Identification.* Nystagmus tape is a device that is a long, narrow strip of fabric or other flexible material on which a series of objects are printed. The device is intended to be moved across a patient's field of vision to elicit optokinetic nystagmus (abnormal and irregular eye movements) and to test for blindness.

(b) *Classification.* Class I (general controls). The device is exempt from the premarket notification procedures in subpart E of part 807 of this chapter, subject to the limitations in § 886.9. The device is also exempt from the current good manufacturing practice requirements of the quality system regulation in part 820 of this chapter, with the exception of § 820.180, with respect to general requirements concerning records, and § 820.198, with respect to complaint files.

[52 FR 33355, Sept. 2, 1987, as amended at 53 FR 35606, Sept. 14, 1988; 66 FR 38813, July 25, 2001]

### § 886.1910 Spectacle dissociation test system.

(a) *Identification.* A spectacle dissociation test system is an AC-powered or battery-powered device, such as a Lancaster test system, that consists of a light source and various filters, usually red or green filters, intended to subjectively measure imbalance of ocular muscles.

(b) *Classification.* Class I (general controls). The AC-powered device and the battery-powered device are exempt from the premarket notification procedures in subpart E of part 807 of this chapter, subject to the limitations in § 886.9. The battery-powered device is also exempt from the current good manufacturing practice requirements of the quality system regulation in part 820 of this chapter, with the exception of § 820.180, with respect to general requirements concerning records, and

## 21 CFR Ch. I (4-1-20 Edition)

§ 820.198, with respect to complaint files.

[55 FR 48442, Nov. 20, 1990; 55 FR 51799, Dec. 17, 1990, as amended at 59 FR 63013, Dec. 7, 1994; 66 FR 38813, July 25, 2001]

### § 886.1925 Diurnal pattern recorder system.

(a) *Identification.* A diurnal pattern recorder system is a nonimplantable, prescription device incorporating a telemetric sensor to detect changes in ocular dimension for monitoring diurnal patterns of intraocular pressure (IOP) fluctuations.

(b) *Classification.* Class II (special controls). The special controls for this device are:

(1) Clinical performance data must demonstrate that the device and all of its components perform as intended under anticipated conditions of use. The following performance characteristics must be demonstrated:

(i) Ability of the device to detect diurnal changes.

(ii) Tolerability of the system at the corneoscleral interface in the intended use population.

(2) Nonclinical testing must validate measurements in an appropriate non-clinical testing model to ensure ability to detect changes in intraocular pressure.

(3) Patient-contacting components must be demonstrated to be biocompatible.

(4) Any component that is intended to contact the eye must be demonstrated to be sterile throughout its intended shelf life.

(5) Software verification, validation, and hazard analysis must be performed.

(6) Performance testing must demonstrate the electromagnetic compatibility and electromagnetic interference of the device.

(7) Performance testing must demonstrate electrical safety of the device.

(8) Labeling must include the following:

(i) Warning against activities and environments that may put the user at greater risk.

(ii) Specific instructions for the safe use of the device, which includes:

(A) Description of all device components and instructions for assembling the device;

## Food and Drug Administration, HHS

## § 886.3200

(B) Explanations of all available programs and instructions for their use;

(C) Instructions and explanation of all user-interface components;

(D) Instructions on all safety features of the device; and

(E) Instructions for properly maintaining the device.

(iii) A summary of nonclinical testing information to describe EMC safety considerations.

(iv) A summary of safety information obtained from clinical testing.

(v) Patient labeling to convey information regarding appropriate use of device.

[81 FR 34270, May 31, 2016]

### § 886.1930 Tonometer and accessories.

(a) *Identification.* A tonometer and accessories is a manual device intended to measure intraocular pressure by applying a known force on the globe of the eye and measuring the amount of indentation produced (Schiotz type) or to measure intraocular tension by applanation (applying a small flat disk to the cornea). Accessories for the device may include a tonometer calibrator or a tonograph recording system. The device is intended for use in the diagnosis of glaucoma.

(b) *Classification.* Class II.

### § 886.1940 Tonometer sterilizer.

(a) *Identification.* A tonometer sterilizer is an AC-powered device intended to heat sterilize a tonometer (a device used to measure intraocular pressure).

(b) *Classification.* Class I (general controls). The device is exempt from the premarket notification procedures in subpart E of part 807 of this chapter subject to § 886.9.

[55 FR 48443, Nov. 20, 1990, as amended at 65 FR 2321, Jan. 14, 2000]

### § 886.1945 Transilluminator.

(a) *Identification.* A transilluminator is an AC-powered or battery-powered device that is a light source intended to transmit light through tissues to aid examination of patients.

(b) *Classification.* (1) Class I (general controls) for the battery-powered device. The battery-powered device is exempt from the premarket notification procedures in subpart E of part 807 of

this chapter subject to the limitations in § 886.9.

(2) Class II (special controls) for the AC-powered device. The AC-powered device is exempt from the premarket notification procedures in subpart E of part 807 of this chapter subject to the limitations in § 886.9.

[55 FR 48443, Nov. 20, 1990, as amended at 59 FR 63013, Dec. 7, 1994; 66 FR 38813, July 25, 2001; 84 FR 71817, Dec. 30, 2019]

## Subpart C [Reserved]

## Subpart D—Prosthetic Devices

### § 886.3100 Ophthalmic tantalum clip.

(a) *Identification.* An ophthalmic tantalum clip is a malleable metallic device intended to be implanted permanently or temporarily to bring together the edges of a wound to aid healing or prevent bleeding from small blood vessels in the eye.

(b) *Classification.* Class II (special controls). The device is exempt from the premarket notification procedures in subpart E of part 807 of this chapter subject to § 886.9.

[52 FR 33355, Sept. 2, 1987, as amended at 63 FR 59230, Nov. 3, 1998]

### § 886.3130 Ophthalmic conformer.

(a) *Identification.* An ophthalmic conformer is a device usually made of molded plastic intended to be inserted temporarily between the eyeball and eyelid to maintain space in the orbital cavity and prevent closure or adhesions during the healing process following surgery.]

(b) *Classification.* Class II (special controls). The device is exempt from the premarket notification procedures in subpart E of part 807 of this chapter subject to § 886.9.

[52 FR 33355, Sept. 2, 1987, as amended at 63 FR 59230, Nov. 3, 1998]

### § 886.3200 Artificial eye.

(a) *Identification.* An artificial eye is a device resembling the anterior portion of the eye, usually made of glass or plastic, intended to be inserted in a patient's eye socket anterior to an orbital implant, or the eviscerated eyeball, for cosmetic purposes. The device is not intended to be implanted.

## § 886.3300

(b) *Classification*. Class I (general controls). The device is exempt from the premarket notification procedures in subpart E of part 807 of this chapter, subject to the limitations in § 886.9, if the device is made from the same materials, has the same chemical composition, and uses the same manufacturing processes as currently legally marketed devices.

[61 FR 1124, Jan. 16, 1996, as amended at 66 FR 38813, July 25, 2001]

### § 886.3300 Absorbable implant (scleral buckling method).

(a) *Identification*. An absorbable implant (scleral buckling method) is a device intended to be implanted on the sclera to aid retinal reattachment.

(b) *Classification*. Class II.

### § 886.3320 Eye sphere implant.

(a) *Identification*. An eye sphere implant is a device intended to be implanted in the eyeball to occupy space following the removal of the contents of the eyeball with the sclera left intact.

(b) *Classification*. Class II (special controls). The device, when it is an ocular peg which is supplied sterile only, is exempt from the premarket notification procedures in subpart E of part 807 of this chapter subject to the limitations in § 886.9.

[52 FR 33355, Sept. 2, 1987, as amended at 84 FR 71817, Dec. 30, 2019]

### § 886.3340 Extraocular orbital implant.

(a) *Identification*. An extraocular orbital implant is a nonabsorbable device intended to be implanted during scleral surgery for buckling or building up the floor of the eye, usually in conjunction with retinal reattachment. Injectable substances are excluded.

(b) *Classification*. Class II.

### § 886.3400 Keratoprosthesis.

(a) *Identification*. A keratoprosthesis is a device intended to provide a transparent optical pathway through an opacified cornea, either intraoperatively or permanently, in an eye that is not a reasonable candidate for a corneal transplant.

(b) *Classification*. Class II. The special controls for this device are FDA's:

## 21 CFR Ch. I (4–1–20 Edition)

(1) “Use of International Standard ISO 10993 ‘Biological Evaluation of Medical Devices—Part I: Evaluation and Testing,’”

(2) “510(k) Sterility Review Guidance of 2/12/90 (K90–1),” and

(3) “Guidance on 510(k) Submissions for Keratoprostheses.”

[65 FR 17147, Mar. 31, 2000]

### § 886.3600 Intraocular lens.

(a) *Identification*. An intraocular lens is a device made of materials such as glass or plastic intended to be implanted to replace the natural lens of an eye.

(b) *Classification*. Class III.

(c) *Date PMA or notice of completion of a PDP is required*. As of May 28, 1976, an approval under section 515 of the act is required before this device may be commercially distributed. See § 886.3.

### § 886.3800 Scleral shell.

(a) *Identification*. A scleral shell is a device made of glass or plastic that is intended to be inserted for short time periods over the cornea and proximal-cornea sclera for cosmetic or reconstructive purposes. An artificial eye is usually painted on the device. The device is not intended to be implanted.

(b) *Classification*. Class II (special controls). The device is exempt from the premarket notification procedures in subpart E of part 807 of this chapter subject to § 886.9.

[52 FR 33355, Sept. 2, 1987, as amended at 63 FR 59230, Nov. 3, 1998]

### § 886.3920 Aqueous shunt.

(a) *Identification*. An aqueous shunt is an implantable device intended to reduce intraocular pressure in the anterior chamber of the eye in patients with neovascular glaucoma or with glaucoma when medical and conventional surgical treatments have failed.

(b) *Classification*. Class II. The special controls for this device are FDA's:

(1) “Use of International Standard ISO 10993 ‘Biological Evaluation of Medical Devices—Part I: Evaluation and Testing,’”

(2) “510(k) Sterility Review Guidance of 2/12/90 (K90–1),” and

(3) “Aqueous Shunts—510(k) Submissions.”

[65 FR 17147, Mar. 31, 2000, as amended at 66 FR 18542, Apr. 10, 2001]

### Subpart E—Surgical Devices

#### § 886.4070 Powered corneal burr.

(a) *Identification.* A powered corneal burr is an AC-powered or battery-powered device that is a motor and drilling tool intended to remove rust rings from the cornea of the eye.

(b) *Classification.* Class I (general controls). The device is exempt from the premarket notification procedures in subpart E of part 807 of this chapter subject to the limitations in § 886.9.

[55 FR 48443, Nov. 20, 1990; 55 FR 51799, Dec. 17, 1990, as amended at 65 FR 2321, Jan. 14, 2000; 84 FR 71817, Dec. 30, 2019]

#### § 886.4100 Radiofrequency electro-surgical cautery apparatus.

(a) *Identification.* A radiofrequency electro-surgical cautery apparatus is an AC-powered or battery-powered device intended for use during ocular surgery to coagulate tissue or arrest bleeding by a high frequency electric current.

(b) *Classification.* Class II.

#### § 886.4115 Thermal cautery unit.

(a) *Identification.* A thermal cautery unit is an AC-powered or battery-powered device intended for use during ocular surgery to coagulate tissue or arrest bleeding by heat conducted through a wire tip.

(b) *Classification.* Class II.

#### § 886.4150 Vitreous aspiration and cutting instrument.

(a) *Identification.* A vitreous aspiration and cutting instrument is an electrically powered device, which may use ultrasound, intended to remove vitreous matter from the vitreous cavity or remove a crystalline lens.

(b) *Classification.* Class II (special controls). The device, when it is phacofragmentation unit replacement tubing, is exempt from the premarket notification procedures in subpart E of part 807 of this chapter subject to the limitations in § 886.9.

[52 FR 33355, Sept. 2, 1987, as amended at 84 FR 71817, Dec. 30, 2019]

#### § 886.4155 Scleral plug.

(a) *Identification.* A scleral plug is a prescription device intended to provide temporary closure of a scleral incision during an ophthalmic surgical procedure. These plugs prevent intraocular fluid and pressure loss when instruments are withdrawn from the eye. Scleral plugs include a head portion remaining above the sclera, which can be gripped for insertion and removal, and a shaft that fits inside the scleral incision. Scleral plugs are removed before completing the surgery.

(b) *Classification.* Class II (special controls). The special controls for the scleral plug are as follows:

(1) The device is exempt from the premarket notification procedures in subpart E of part 807 of this chapter subject to the limitations in § 886.9 if the material is a surgical grade stainless steel with or without a gold, silver, or titanium coating. The special controls for the surgical grade stainless steel scleral plug (with or without a gold, silver, or titanium coating) are:

(i) The device must be demonstrated to be sterile during the labeled shelf life;

(ii) The device must be demonstrated to be biocompatible; and

(iii) Labeling must include all information required for the safe and effective use of the device, including specific instructions regarding the proper sizing, placement, and removal of the device.

(2) The device is not exempt from premarket notification procedures if it is composed of a material other than surgical grade stainless steel (with or without a gold, silver, or titanium coating). The special controls for scleral plugs made of other materials are:

(i) The device must be demonstrated to be sterile during the labeled shelf life;

(ii) The device must be demonstrated to be biocompatible;

(iii) Characterization of the device materials must be performed;

(iv) Performance data must demonstrate acceptable mechanical properties under simulated clinical use conditions including insertion and removal of the device;

**§ 886.4170**

**21 CFR Ch. I (4–1–20 Edition)**

(v) Performance data must demonstrate adequately low levels of the extractables or residues from manufacturing (or processing) of the device; and

(vi) Labeling must include all information required for the safe and effective use of the device, including specific instructions regarding the proper sizing, placement, and removal of the device.

[78 FR 68715, Nov. 15, 2013]

**§ 886.4170 Cryophthalmic unit.**

(a) *Identification.* A cryophthalmic unit is a device that is a probe with a small tip that becomes extremely cold through the controlled use of a refrigerant or gas. The device may be AC-powered. The device is intended to remove cataracts by the formation of an adherent ice ball in the lens, to freeze the eye and adjunct parts for surgical removal of scars, and to freeze tumors.

(b) *Classification.* Class II.

**§ 886.4230 Ophthalmic knife test drum.**

(a) *Identification.* An ophthalmic knife test drum is a device intended to test the keenness of ophthalmic surgical knives to determine whether resharpening is needed.

(b) *Classification.* Class I (general controls). The device is exempt from the premarket notification procedures in subpart E of part 807 of this chapter, subject to the limitations in § 886.9. The device is also exempt from the current good manufacturing practice requirements of the quality system regulation in part 820 of this chapter, with the exception of § 820.180, with respect to general requirements concerning records, and § 820.198, with respect to complaint files.

[52 FR 33355, Sept. 2, 1987, as amended at 53 FR 35606, Sept. 14, 1988; 66 FR 38813, July 25, 2001]

**§ 886.4250 Ophthalmic electrolysis unit.**

(a) *Identification.* An ophthalmic electrolysis unit is an AC-powered or battery-powered device intended to destroy ocular hair follicles by applying a galvanic electrical current.

(b) *Classification.* (1) Class I (general controls) for the battery-powered de-

vice. The battery-powered device is exempt from the premarket notification procedures in subpart E of part 807 of this chapter subject to the limitations in § 886.9.

(2) Class II (special controls) for the AC-powered device. The AC-powered device is exempt from the premarket notification procedures in subpart E of part 807 of this chapter subject to the limitations in § 886.9.

[55 FR 48443, Nov. 20, 1990, as amended at 59 FR 63013, Dec. 7, 1994; 66 FR 38813, July 25, 2001; 84 FR 71817, Dec. 30, 2019]

**§ 886.4270 Intraocular gas.**

(a) *Identification.* An intraocular gas is a device consisting of a gaseous fluid intended to be introduced into the eye to place pressure on a detached retina.

(b) *Classification.* Class III.

(c) *Date PMA or notice of completion of a PDP is required.* As of May 28, 1976, an approval under section 515 of the act is required before this device may be commercially distributed. See § 886.3.

**§ 886.4275 Intraocular fluid.**

(a) *Identification.* An intraocular fluid is a device consisting of a nongaseous fluid intended to be introduced into the eye to aid performance of surgery, such as to maintain anterior chamber depth, preserve tissue integrity, protect tissue from surgical trauma, or function as a tamponade during retinal reattachment.

(b) *Classification.* Class III.

(c) *Date PMA or notice of completion of a PDP is required.* As of May 28, 1976, an approval under section 515 of the act is required before this device may be commercially distributed. See § 886.3.

**§ 886.4280 Intraocular pressure measuring device.**

(a) *Identification.* An intraocular pressure measuring device is a manual or AC-powered device intended to measure intraocular pressure. Also included are any devices found by FDA to be substantially equivalent to such devices. Accessories for the device may include calibrators or recorders. The device is intended for use in the diagnosis of glaucoma.

(b) *Classification.* Class III.

(c) *Date PMA or notice of completion of PDP is required.* As of May 28, 1976, an

approval under section 515 of the act is required before this device may be commercially distributed. See § 886.3.

**§ 886.4300 Intraocular lens guide.**

(a) *Identification.* An intraocular lens guide is a device intended to be inserted into the eye during surgery to direct the insertion of an intraocular lens and be removed after insertion is completed.

(b) *Classification.* Class I (general controls). Except when used as folders or injectors for soft or foldable intraocular lenses, the device is exempt from the premarket notification procedures in subpart E of part 807 of this chapter subject to § 886.9.

[52 FR 33355, Sept. 2, 1987, as amended at 65 FR 2321, 2000]

**§ 886.4335 Operating headlamp.**

(a) *Identification.* An operating headlamp is an AC-powered or battery-powered device intended to be worn on the user's head to provide a light source to aid visualization during surgical, diagnostic, or therapeutic procedures.

(b) *Classification.* (1) Class I (general controls) for the battery-powered device. The battery-powered device is exempt from the premarket notification procedures in subpart E of part 807 of this chapter subject to the limitations in § 886.9.

(2) Class II (special controls) for the AC-powered device. The AC-powered device is exempt from the premarket notification procedures in subpart E of part 807 of this chapter subject to the limitations in § 886.9.

[55 FR 48443, Nov. 20, 1990, as amended at 66 FR 38813, July 25, 2001; 84 FR 71817, Dec. 30, 2019]

**§ 886.4350 Manual ophthalmic surgical instrument.**

(a) *Identification.* A manual ophthalmic surgical instrument is a non-powered, handheld device intended to aid or perform ophthalmic surgical procedures. This generic type of device includes the manual corneal burr, ophthalmic caliper, ophthalmic cannula, eyelid clamp, ophthalmic muscle clamp, iris retractor clip, orbital compressor, ophthalmic curette,

cystotome, orbital depressor, lachrymal dilator, erisophake, expressor, ophthalmic forcep, ophthalmic hook, sphere introducer, ophthalmic knife, ophthalmic suturing needle, lachrymal probe, trabeculotomy probe, cornea-sclera punch, ophthalmic retractor, ophthalmic ring (Flieringa), lachrymal sac rongeur, ophthalmic scissors, enucleating snare, ophthalmic spatula, ophthalmic specula, ophthalmic spoon, ophthalmic spud, trabeculotome or ophthalmic manual trephine.

(b) *Classification.* Class I (general controls). The device is exempt from the premarket notification procedures in subpart E of part 807 of this chapter, subject to the limitations in § 886.9.

[52 FR 33355, Sept. 2, 1987, as amended at 53 FR 35606, Sept. 14, 1988; 59 FR 63013, Dec. 7, 1994; 60 FR 15872, Mar. 28, 1995; 66 FR 38813, July 25, 2001]

**§ 886.4355 Corneal inlay inserter handle.**

(a) *Identification.* The corneal inlay inserter handle is a hand-held device intended to be used as an accessory to a corneal inlay inserter. The device extends the length of the inlay inserter to aid in delivering the inlay implant.

(b) *Classification.* Class I (general controls). The device is exempt from the premarket notification procedures in subpart E of part 807 of this chapter subject to the limitations in § 886.9.

[84 FR 14870, Apr. 12, 2019]

**§ 886.4360 Ocular surgery irrigation device.**

(a) *Identification.* An ocular surgery irrigation device is a device intended to be suspended over the ocular area during ophthalmic surgery to deliver continuous, controlled irrigation to the surgical field.

(b) *Classification.* Class I (general controls). The device is exempt from the premarket notification procedures in subpart E of part 807 of this chapter, subject to the limitations in § 886.9.

[52 FR 33355, Sept. 2, 1987, as amended at 53 FR 35606, Sept. 14, 1988; 59 FR 63013, Dec. 7, 1994; 66 FR 38813, July 25, 2001]

**§ 886.4370 Keratome.**

(a) *Identification.* A keratome is an AC-powered or battery-powered device

**§ 886.4390**

intended to shave tissue from sections of the cornea for a lamellar (partial thickness) transplant.

(b) *Classification.* Class I.

[55 FR 48443, Nov. 20, 1990]

**§ 886.4390 Ophthalmic laser.**

(a) *Identification.* An ophthalmic laser is an AC-powered device intended to coagulate or cut tissue of the eye, orbit, or surrounding skin by a laser beam.

(b) *Classification.* Class II.

**§ 886.4392 Nd:YAG laser for posterior capsulotomy and peripheral iridotomy.**

(a) *Identification.* The Nd:YAG laser for posterior capsulotomy and peripheral iridotomy consists of a mode-locked or Q-switched solid state Nd:YAG laser intended for disruption of the posterior capsule or the iris via optical breakdown. The Nd:YAG laser generates short pulse, low energy, high power, coherent optical radiation. When the laser output is combined with focusing optics, the high irradiance at the target causes tissue disruption via optical breakdown. A visible aiming system is utilized to target the invisible Nd:YAG laser radiation on or in close proximity to the target tissue.

(b) *Classification.* Class II (special controls). Design Parameters: Device must emit a laser beam with the following parameters: wavelength = 1064 nanometers; spot size = 50 to 100 micros; pulse width = 3 to 30 nanoseconds; output energy per pulse = 0.5 to 15 millijoules (mJ); repetition rate = 1 to 10 pulses; and total energy = 20 to 120 mJ.

[65 FR 6894, Feb. 11, 2000]

**§ 886.4400 Electronic metal locator.**

(a) *Identification.* An electronic metal locator is an AC-powered device with probes intended to locate metallic foreign bodies in the eye or eye socket.

(b) *Classification.* Class II (special controls). The device is exempt from the premarket notification procedures in subpart E of part 807 of this chapter subject to the limitations in § 886.9.

[52 FR 33355, Sept. 2, 1987, as amended at 84 FR 71817, Dec. 30, 2019]

**21 CFR Ch. I (4–1–20 Edition)**

**§ 886.4440 AC-powered magnet.**

(a) *Identification.* An AC-powered magnet is an AC-powered device that generates a magnetic field intended to find and remove metallic foreign bodies from eye tissue.

(b) *Classification.* Class II (special controls). The device is exempt from the premarket notification procedures in subpart E of part 807 of this chapter subject to the limitations in § 886.9.

[52 FR 33355, Sept. 2, 1987, as amended at 84 FR 71817, Dec. 30, 2019]

**§ 886.4445 Permanent magnet.**

(a) *Identification.* A permanent magnet is a nonelectric device that generates a magnetic field intended to find and remove metallic foreign bodies from eye tissue.

(b) *Classification.* Class I (general controls). The device is exempt from the premarket notification procedures in subpart E of part 807 of this chapter, subject to the limitations in § 886.9. The device is also exempt from the current good manufacturing practice requirements of the quality system regulation in part 820 of this chapter, with the exception of § 820.180, with respect to general requirements concerning records, and § 820.198, with respect to complaint files.

[52 FR 33355, Sept. 2, 1987, as amended at 53 FR 35606, Sept. 14, 1988; 66 FR 38813, July 25, 2001]

**§ 886.4570 Ophthalmic surgical marker.**

(a) *Identification.* An ophthalmic surgical marker is a device intended to mark by use of ink, dye, or indentation the location of ocular or scleral surgical manipulation.

(b) *Classification.* Class I (general controls). The device is exempt from the premarket notification procedures in subpart E of part 807 of this chapter, subject to the limitations in § 886.9.

[52 FR 33355, Sept. 2, 1987, as amended at 53 FR 35606, Sept. 14, 1988; 59 FR 63013, Dec. 7, 1994; 66 FR 38813, July 25, 2001]

**§ 886.4610 Ocular pressure applicator.**

(a) *Identification.* An ocular pressure applicator is a manual device that consists of a sphygmomanometer-type squeeze bulb, a dial indicator, a band,



and bellows, intended to apply pressure on the eye in preparation for ophthalmic surgery.

(b) *Classification*. Class II.

**§ 886.4670 Phacofragmentation system.**

(a) *Identification*. A phacofragmentation system is an AC-powered device with a fragmenting needle intended for use in cataract surgery to disrupt a cataract with ultrasound and extract the cataract.

(b) *Classification*. Class II.

**§ 886.4690 Ophthalmic photocoagulator.**

(a) *Identification*. An ophthalmic photocoagulator is an AC-powered device intended to use the energy from an extended noncoherent light source to occlude blood vessels of the retina, choroid, or iris.

(b) *Classification*. Class II.

**§ 886.4750 Ophthalmic eye shield.**

(a) *Identification*. An ophthalmic eye shield is a device that consists of a plastic or aluminum eye covering intended to protect the eye or retain dressing materials in place.

(b) *Classification*. Class I (general controls). When made only of plastic or aluminum, the device is exempt from the premarket notification procedures in subpart E of part 807 of this chapter subject to § 886.9. When made only of plastic or aluminum, the devices are exempt from the current good manufacturing practice requirements of the quality system regulation in part 820 of this chapter, with the exception of § 820.180 of this chapter, with respect to general requirements concerning records, and § 820.198 of this chapter, with respect to complaint files.

[52 FR 33355, Sept. 2, 1987, as amended at 59 FR 63014, Dec. 7, 1994; 65 FR 2321, Jan. 14, 2000]

**§ 886.4770 Ophthalmic operating spectacles (loupes).**

(a) *Identification*. Ophthalmic operating spectacles (loupes) are devices that consist of convex lenses or lens systems intended to be worn by a surgeon to magnify the surgical site during ophthalmic surgery.

(b) *Classification*. Class I (general controls). The device is exempt from the

premarket notification procedures in subpart E of part 807 of this chapter, subject to the limitations in § 886.9. The device is also exempt from the current good manufacturing practice requirements of the quality system regulation in part 820 of this chapter, with the exception of § 820.180, with respect to general requirements concerning records, and § 820.198, with respect to complaint files.

[52 FR 33355, Sept. 2, 1987, as amended at 53 FR 35606, Sept. 14, 1988; 66 FR 38813, July 25, 2001]

**§ 886.4790 Ophthalmic sponge.**

(a) *Identification*. An ophthalmic sponge is a device that is an absorbant sponge, pad, or spear made of folded gauze, cotton, cellulose, or other material intended to absorb fluids from the operative field in ophthalmic surgery.

(b) *Classification*. Class II (special controls). The device is exempt from the premarket notification procedures in subpart E of part 807 of this chapter subject to the limitations in § 886.9.

[52 FR 33355, Sept. 2, 1987, as amended at 84 FR 71817, Dec. 30, 2019]

**§ 886.4855 Ophthalmic instrument table.**

(a) *Identification*. An ophthalmic instrument table is an AC-powered or manual device on which ophthalmic instruments are intended to be placed.

(b) *Classification*. Class I (general controls). The AC-powered device and the manual device are exempt from the premarket notification procedures in subpart E of part 807 of this chapter, subject to the limitations in § 886.9. The manual device is also exempt from the current good manufacturing practice requirements of the quality system regulation in part 820 of this chapter, with the exception of § 820.180, with respect to general requirements concerning records, and § 820.198, with respect to complaint files.

[55 FR 48443, Nov. 20, 1990, as amended at 59 FR 63014, Dec. 7, 1994; 66 FR 38814, July 25, 2001]

**Subpart F—Therapeutic Devices****§ 886.5100 Ophthalmic beta radiation source.**

(a) *Identification.* An ophthalmic beta radiation source is a device intended to apply superficial radiation to benign and malignant ocular growths.

(b) *Classification.* Class II.

**§ 886.5120 Low-power binocular loupe.**

(a) *Identification.* A low-power binocular loupe is a device that consists of two eyepieces, each with a lens or lens system, intended for medical purposes to magnify the appearance of objects.

(b) *Classification.* Class I (general controls). The device is exempt from the premarket notification procedures in subpart E of part 807 of this chapter, subject to the limitations in § 886.9. The device is also exempt from the current good manufacturing practice requirements of the quality system regulation in part 820 of this chapter, with the exception of § 820.180, with respect to general requirements concerning records, and § 820.198, with respect to complaint files.

[52 FR 33355, Sept. 2, 1987, as amended at 53 FR 35607, Sept. 14, 1988; 66 FR 38814, July 25, 2001]

**§ 886.5200 Eyelid thermal pulsation system.**

(a) *Identification.* An eyelid thermal pulsation system is an electrically-powered device intended for use in the application of localized heat and pressure therapy to the eyelids. The device is used in adult patients with chronic cystic conditions of the eyelids, including meibomian gland dysfunction (MGD), also known as evaporative dry eye or lipid deficiency dry eye. The system consists of a component that is inserted around the eyelids and a component to control the application of heat and pressure to the eyelids.

(b) *Classification.* Class II (special controls). The special controls for this device are:

(1) Appropriate analysis/testing should validate electromagnetic compatibility (EMC) and safety of exposure to non-ionizing radiation;

(2) Design, description, and performance data should validate safeguards related to the temperature and pres-

sure aspects of the device, including during fault conditions;

(3) Performance data should demonstrate the sterility of patient-contacting components and the shelf-life of these components;

(4) The device should be demonstrated to be biocompatible; and

(5) Performance data should demonstrate that any technological changes do not adversely effect safety and effectiveness.

[76 FR 51878, Aug. 19, 2011]

**§ 886.5300 Tear electrostimulation device.**

(a) *Identification.* A tear electrostimulation device is a non-implantable, electrostimulation device intended to increase tear production.

(b) *Classification.* Class II (special controls). The special controls for this device are:

(1) Non-clinical performance testing must assess the following electrical output specifications: waveforms, output modes, maximum output voltage, maximum output current, pulse duration, frequency, net charge per pulse, maximum phase charge at 500 ohms, maximum current density, maximum average current, and maximum average power density.

(2) Patient-contacting components of the device must be demonstrated to be biocompatible.

(3) Performance testing must demonstrate the electrical, thermal, and mechanical safety along with electromagnetic compatibility (EMC) of the device in the intended use environment.

(4) Software verification, validation, and hazard analysis must be performed.

(5) Physician and patient labeling must include:

(i) Summaries of electrical stimulation parameters;

(ii) Instructions on how to correctly use and maintain the device;

(iii) Instructions and explanations of all user-interface components;

(iv) Information related to electromagnetic compatibility classification; and

(v) Instructions on how to clean the device.

[82 FR 60116, Dec. 19, 2017]

**§ 886.5310 Intranasal electrostimulation device for dry eye symptoms.**

(a) *Identification.* An intranasal electrostimulation device for dry eye symptoms is a prescription non-implantable, electrostimulation device intended to increase tear production for improvement in dry eye symptoms.

(b) *Classification.* Class II (special controls). The special controls for this device are:

(1) Clinical performance testing must evaluate improvement of dry eye symptoms under anticipated conditions of use.

(2) Non-clinical performance testing must assess the following electrical output specifications: waveforms, output modes, maximum output voltage, maximum output current, pulse duration, frequency, net charge per pulse, maximum phase charge at 500 ohms, maximum current density, maximum average current, and maximum average power density.

(3) Patient-contacting components of the device must be demonstrated to be biocompatible.

(4) Performance testing must demonstrate the electrical, thermal, and mechanical safety along with electromagnetic compatibility (EMC) of the device in the intended use environment.

(5) Software verification, validation, and hazard analysis must be performed.

(6) Training for the proper use of the device must be provided.

(7) Physician and patient labeling must include:

(i) Summaries of electrical stimulation parameters;

(ii) Instructions on how to correctly use and maintain the device;

(iii) Instructions and explanations of all user-interface components;

(iv) Information related to electromagnetic compatibility classification;

(v) Instructions on how to clean the device; and

(vi) Summaries of clinical performance testing demonstrating safety and effectiveness.

[83 FR 52975, Oct. 19, 2018]

**§ 886.5420 Contact lens inserter/remover.**

(a) *Identification.* A contact lens inserter/remover is a handheld device intended to insert or remove contact lenses by surface adhesion or suction.

(b) *Classification.* Class I (general controls). The device is exempt from the premarket notification procedures in subpart E of part 807 of this chapter, subject to the limitations in § 886.9.

[52 FR 33355, Sept. 2, 1987, as amended at 53 FR 35607, Sept. 14, 1988; 66 FR 38814, July 25, 2001]

**§ 886.5540 Low-vision magnifier.**

(a) *Identification.* A low-vision magnifier is a device that consists of a magnifying lens intended for use by a patient who has impaired vision. The device may be held in the hand or attached to spectacles.

(b) *Classification.* Class I (general controls). The device is exempt from the premarket notification procedures in subpart E of part 807 of this chapter, subject to the limitations in § 886.9. The device is also exempt from the current good manufacturing practice requirements of the quality system regulation in part 820 of this chapter, with the exception of § 820.180, with respect to general requirements concerning records, and § 820.198, with respect to complaint files.

[52 FR 33355, Sept. 2, 1987, as amended at 53 FR 35607, Sept. 14, 1988; 66 FR 38814, July 25, 2001]

**§ 886.5600 Ptosis crutch.**

(a) *Identification.* A ptosis crutch is a device intended to be mounted on the spectacles of a patient who has ptosis (drooping of the upper eyelid as a result of faulty development or paralysis) to hold the upper eyelid open.

(b) *Classification.* Class I (general controls). The device is exempt from the premarket notification procedures in subpart E of part 807 of this chapter, subject to the limitations in § 886.9. The device is also exempt from the current good manufacturing practice requirements of the quality system regulation in part 820 of this chapter, with the exception of § 820.180, with respect to general requirements concerning records,

## § 886.5700

and § 820.198, with respect to complaint files.

[52 FR 33355, Sept. 2, 1987, as amended at 53 FR 35607, Sept. 14, 1988; 66 FR 38814, July 25, 2001]

### § 886.5700 Eyelid weight.

(a) *Identification.* An eyelid weight is a prescription device made of gold, tantalum, platinum, iridium, or surgical grade stainless steel that is rectangular in shape and contoured to the shape of the eye. The device is intended for the gravity assisted treatment of lagophthalmos (incomplete eyelid closure).

(1) The external eyelid weight is adhered to the outer skin of the upper eyelid.

(2) The implantable eyelid weight is implanted into the upper eyelid.

(b) *Classification.* (1) Class II (special controls) for the external eyelid weight. The external eyelid weight is exempt from the premarket notification procedures in subpart E of part 807 of this chapter subject to the limitations in § 886.9. The special controls for the external eyelid weight are:

(i) Testing demonstrating the biocompatibility of the device; and

(ii) Labeling must include the following information:

(A) Specific instructions regarding the proper placement, sizing, and removal of the device; and

(B) A warning stating that the patient should be instructed to remove the device prior to entering a magnetic resonance environment.

(2) Class II (special controls) for the implantable eyelid weight. The special controls for the implantable eyelid weight are:

(i) Testing demonstrating the biocompatibility of the device;

(ii) Testing demonstrating the sterility and shelf life of the device;

(iii) Nonclinical testing evaluating the compatibility of the device in a magnetic resonance environment.

(iv) Patient labeling to convey information regarding the safety and compatibility of the device in a magnetic resonance environment, the conditions under which a patient with the device can be safely scanned, and a mechanism for a healthcare provider to obtain detailed information about mag-

## 21 CFR Ch. I (4–1–20 Edition)

netic resonance safety and compatibility if needed.

[79 FR 22015, Apr. 21, 2014]

### § 886.5800 Ophthalmic bar reader.

(a) *Identification.* An ophthalmic bar reader is a device that consists of a magnifying lens intended for use by a patient who has impaired vision. The device is placed directly onto reading material to magnify print.

(b) *Classification.* Class I (general controls). The device is exempt from the premarket notification procedures in subpart E of part 807 of this chapter, subject to the limitations in § 886.9. The device is also exempt from the current good manufacturing practice requirements of the quality system regulation in part 820 of this chapter, with the exception of § 820.180, with respect to general requirements concerning records, and § 820.198, with respect to complaint files.

[52 FR 33355, Sept. 2, 1987, as amended at 53 FR 35607, Sept. 14, 1988; 66 FR 38814, July 25, 2001]

### § 886.5810 Ophthalmic prism reader.

(a) *Identification.* An ophthalmic prism reader is a device intended for use by a patient who is in a supine position to change the angle of print to aid reading.

(b) *Classification.* Class I (general controls). The device is exempt from the premarket notification procedures in subpart E of part 807 of this chapter, subject to the limitations in § 886.9. The device is also exempt from the current good manufacturing practice requirements of the quality system regulation in part 820 of this chapter, with the exception of § 820.180, with respect to general requirements concerning records, and § 820.198, with respect to complaint files.

[52 FR 33355, Sept. 2, 1987, as amended at 53 FR 35607, Sept. 14, 1988; 66 FR 38814, July 25, 2001]

### § 886.5820 Closed-circuit television reading system.

(a) *Identification.* A closed-circuit television reading system is a device that consists of a lens, video camera, and video monitor that is intended for use

by a patient who has subnormal vision to magnify reading material.

(b) *Classification*. Class I (general controls). The device is exempt from the premarket notification procedures in subpart E of part 807 of this chapter, subject to the limitations in § 886.9.

[55 FR 48443, Nov. 20, 1990, as amended at 59 FR 63014, Dec. 7, 1994; 66 FR 38814, July 25, 2001]

**§ 886.5838 Nasolacrimal compression device.**

(a) *Identification*. A nasolacrimal compression device is a prescription device that is fitted to apply mechanical pressure to the nasal aspect of the orbital rim to reduce outflow through the nasolacrimal ducts.

(b) *Classification*. Class I (general controls). The device is exempt from the premarket notification procedures in subpart E of part 807 of this chapter, subject to the limitations in § 886.9.

[81 FR 37500, June 10, 2016]

**§ 886.5840 Magnifying spectacles.**

(a) *Identification*. Magnifying spectacles are devices that consist of spectacle frames with convex lenses intended to be worn by a patient who has impaired vision to enlarge images.

(b) *Classification*. Class I (general controls). The device is exempt from the premarket notification procedures in subpart E of part 807 of this chapter, subject to the limitations in § 886.9.

[52 FR 33355, Sept. 2, 1987, as amended at 53 FR 35607, Sept. 14, 1988; 59 FR 63014, Dec. 7, 1994; 66 FR 38814, July 25, 2001]

**§ 886.5842 Spectacle frame.**

(a) *Identification*. A spectacle frame is a device made of metal or plastic intended to hold prescription spectacle lenses worn by a patient to correct refractive errors.

(b) *Classification*. Class I (general controls). The device is exempt from the premarket notification procedures in subpart E of part 807 of this chapter, subject to the limitations in § 886.9.

[52 FR 33355, Sept. 2, 1987, as amended at 59 FR 63014, Dec. 7, 1994; 66 FR 38814, July 25, 2001]

**§ 886.5844 Prescription spectacle lens.**

(a) *Identification*. A prescription spectacle lens is a glass or plastic device that is a lens intended to be worn by a patient in a spectacle frame to provide refractive corrections in accordance with a prescription for the patient. The device may be modified to protect the eyes from bright sunlight (i.e., prescription sunglasses). Prescription sunglasses lenses may be reflective, tinted, polarizing, or photosensitized.

(b) *Classification*. Class I (general controls). The device is exempt from the premarket notification procedures in subpart E of part 807 of this chapter, subject to the limitations in § 886.9.

[52 FR 33355, Sept. 2, 1987, as amended at 53 FR 35607, Sept. 14, 1988; 59 FR 63014, Dec. 7, 1994; 66 FR 38814, July 25, 2001]

**§ 886.5850 Sunglasses (nonprescription).**

(a) *Identification*. Sunglasses (nonprescription) are devices that consist of spectacle frames or clips with absorbing, reflective, tinted, polarizing, or photosensitized lenses intended to be worn by a person to protect the eyes from bright sunlight but not to provide refractive corrections. This device is usually available over-the-counter.

(b) *Classification*. Class I (general controls). The device is exempt from the premarket notification procedures in subpart E of part 807 of this chapter subject to § 886.9.

[52 FR 33355, Sept. 2, 1987, as amended at 65 FR 2321, 2000]

**§ 886.5870 Low-vision telescope.**

(a) *Identification*. A low-vision telescope is a device that consists of an arrangement of lenses or mirrors intended for use by a patient who has impaired vision to increase the apparent size of objects. This generic type of device includes handheld or spectacle telescopes.

(b) *Classification*. Class I (general controls). The device is exempt from the premarket notification procedures in subpart E of part 807 of this chapter, subject to the limitations in § 886.9. The device is also exempt from the current good manufacturing practice requirements of the quality system regulation

## § 886.5900

## 21 CFR Ch. I (4–1–20 Edition)

in part 820 of this chapter, with the exception of § 820.180, with respect to general requirements concerning records, and § 820.198, with respect to complaint files.

[52 FR 33355, Sept. 2, 1987, as amended at 53 FR 35607, Sept. 14, 1988; 66 FR 38814, July 25, 2001]

### § 886.5900 Electronic vision aid.

(a) *Identification.* An electronic vision aid is an AC-powered or battery-powered device that consists of an electronic sensor/transducer intended for use by a patient who has impaired vision or blindness to translate visual images of objects into tactile or auditory signals.

(b) *Classification.* Class I (general controls). The device is exempt from the premarket notification procedures in subpart E of part 807 of this chapter, subject to the limitations in § 886.9.

[55 FR 48443, Nov. 20, 1990, as amended at 59 FR 63014, Dec. 7, 1994; 66 FR 38814, July 25, 2001]

### § 886.5905 Oral electronic vision aid.

(a) *Identification.* An oral electronic vision aid is a battery-powered prescription device that contains an electrode stimulation array to generate electro tactile stimulation patterns that are derived from digital object images captured by a camera. It is intended to aid profoundly blind patients in orientation, mobility, and object recognition as an adjunctive device to other assistive methods such as a white cane or a guide dog.

(b) *Classification.* Class II (special controls). The special controls for this device are:

(1) Clinical performance testing must demonstrate an acceptable adverse event profile, including adverse events involving the mouth, tongue, and gums and demonstrate the effect of the stimulation to provide clinically meaningful outcomes. The clinical performance testing must also investigate the anticipated conditions of use, including potential use error, intended environment of use, and duration of use.

(2) Non-clinical performance testing must demonstrate that the device performs as intended under anticipated conditions of use, including simulated

moisture ingress, device durability, and battery reliability.

(3) Software verification, validation, and hazard analysis must be performed.

(4) Analysis/testing must validate electromagnetic compatibility.

(5) Analysis/testing must validate electrical safety.

(6) Analysis/testing must assess and validate wireless coexistence concerns.

(7) Any elements of the device that contact the patient must be demonstrated to be biocompatible.

(8) Training must include elements to ensure that the healthcare provider and user can identify the safe environments for device use, use all safety features of the device, and operate the device in the intended environment of use.

(9) Labeling for the trainer and user must include a summary of the clinical testing including adverse events encountered under use conditions, summary of study outcomes and endpoints, and information pertinent to use of the device including the conditions under which the device was studied (*e.g.*, level of supervision or assistance, and environment of use).

[80 FR 57092, Sept. 22, 2015]

### § 886.5910 Image intensification vision aid.

(a) *Identification.* An image intensification vision aid is a battery-powered device intended for use by a patient who has limited dark adaptation or impaired vision to amplify ambient light.

(b) *Classification.* Class I (general controls). The device is exempt from the premarket notification procedures in subpart E of part 807 of this chapter, subject to the limitations in § 886.9. The device is also exempt from the current good manufacturing practice requirements of the quality system regulation in part 820 of this chapter, with the exception of § 820.180, with respect to general requirements concerning records, and § 820.198, with respect to complaint files.

[52 FR 33355, Sept. 2, 1987, as amended at 53 FR 35607, Sept. 14, 1988; 66 FR 38814, July 25, 2001]

**§ 886.5915 Optical vision aid.**

(a) *Identification.* An optical vision aid is a device that consists of a magnifying lens with an accompanying AC-powered or battery-powered light source intended for use by a patient who has impaired vision to increase the apparent size of object detail.

(b) *Classification.* Class I (general controls). The AC-powered device and the battery-powered device are exempt from the premarket notification procedures in subpart E of part 807 of this chapter, subject to the limitations in § 886.9. The battery-powered device is also exempt from the current good manufacturing practice requirements of the quality system regulation in part 820 of this chapter, with the exception of § 820.180, with respect to general requirements concerning records, and § 820.198, with respect to complaint files.

[55 FR 48443, Nov. 20, 1990, as amended at 59 FR 63014, Dec. 7, 1994; 66 FR 38815, July 25, 2001]

**§ 886.5916 Rigid gas permeable contact lens.**

(a) *Identification.* A rigid gas permeable contact lens is a device intended to be worn directly against the cornea of the eye to correct vision conditions. The device is made of various materials, such as cellulose acetate butyrate, polyacrylate-silicone, or silicone elastomers, whose main polymer molecules generally do not absorb or attract water.

(b) *Classification.* (1) Class II if the device is intended for daily wear only.

(2) Class III if the device is intended for extended wear.

(c) *Date PMA or notice of completion of a PDP is required.* As of May 28, 1976, an approval under section 515 of the act is required before a device described in paragraph (b)(2) of this section may be commercially distributed. See § 886.3.

[52 FR 33355, Sept. 2, 1987, as amended at 59 FR 10284, Mar. 4, 1994]

**§ 886.5918 Rigid gas permeable contact lens care products.**

(a) *Identification.* A rigid gas permeable contact lens care product is a device intended for use in the cleaning, conditioning, rinsing, lubricating/re-

wetting, or storing of a rigid gas permeable contact lens. This includes all solutions and tablets used together with rigid gas permeable contact lenses.

(b) *Classification.* Class II (Special Controls) Guidance Document: "Guidance for Industry Premarket Notification (510(k)) Guidance Document for Contact Lens Care Products."

[62 FR 30987, June 6, 1997]

**§ 886.5925 Soft (hydrophilic) contact lens.**

(a) *Identification.* A soft (hydrophilic) contact lens is a device intended to be worn directly against the cornea and adjacent limbal and scleral areas of the eye to correct vision conditions or act as a therapeutic bandage. The device is made of various polymer materials the main polymer molecules of which absorb or attract a certain volume (percentage) of water.

(b) *Classification.* (1) Class II if the device is intended for daily wear only.

(2) Class III if the device is intended for extended wear.

(c) *Date PMA or notice of completion of a PDP is required.* As of May 28, 1976, an approval under section 515 of the act is required before a device described in paragraph (b)(2) of this section may be commercially distributed. See § 886.3.

[52 FR 33355, Sept. 2, 1987, as amended at 59 FR 10284, Mar. 4, 1994]

**§ 886.5928 Soft (hydrophilic) contact lens care products.**

(a) *Identification.* A soft (hydrophilic) contact lens care product is a device intended for use in the cleaning, rinsing, disinfecting, lubricating/rewetting, or storing of a soft (hydrophilic) contact lens. This includes all solutions and tablets used together with soft (hydrophilic) contact lenses and heat disinfecting units intended to disinfect a soft (hydrophilic) contact lens by means of heat.

(b) *Classification.* Class II (Special Controls) Guidance Document: "Guidance for Industry Premarket Notification (510(k)) Guidance Document for Contact Lens Care Products."

[62 FR 30988, June 6, 1997]

§ 886.5933 [Reserved]

**PART 888—ORTHOPEDIC DEVICES**

**Subpart A—General Provisions**

Sec.

- 888.1 Scope.
- 888.3 Effective dates of requirement for pre-market approval.
- 888.5 Resurfacing technique.
- 888.6 Degree of constraint.
- 888.9 Limitations of exemptions from section 510(k) of the Federal Food, Drug, and Cosmetic Act (the act).

**Subpart B—Diagnostic Devices**

- 888.1100 Arthroscope.
- 888.1240 AC-powered dynamometer.
- 888.1250 Nonpowered dynamometer.
- 888.1500 Goniometer.
- 888.1520 Nonpowered goniometer.

**Subpart C [Reserved]**

**Subpart D—Prosthetic Devices**

- 888.3000 Bone cap.
- 888.3010 Bone fixation cerclage.
- 888.3015 Bone heterograft.
- 888.3020 Intramedullary fixation rod.
- 888.3023 In vivo cured intramedullary fixation rod.
- 888.3025 Passive tendon prosthesis.
- 888.3027 Polymethylmethacrylate (PMMA) bone cement.
- 888.3030 Single/multiple component metallic bone fixation appliances and accessories.
- 888.3040 Smooth or threaded metallic bone fixation fastener.
- 888.3045 Resorbable calcium salt bone void filler device.
- 888.3050 Spinal interlaminar fixation orthosis.
- 888.3060 Spinal intervertebral body fixation orthosis.
- 888.3075 Posterior cervical screw system.
- 888.3070 Thoracolumbosacral pedicle screw system.
- 888.3080 Intervertebral body fusion device.
- 888.3100 Ankle joint metal/composite semi-constrained cemented prosthesis.
- 888.3110 Ankle joint metal/polymer semi-constrained cemented prosthesis.
- 888.3120 Ankle joint metal/polymer non-constrained cemented prosthesis.
- 888.3150 Elbow joint metal/polymer constrained cemented prosthesis.
- 888.3160 Elbow joint metal/polymer semi-constrained cemented prosthesis.
- 888.3170 Elbow joint radial (hemi-elbow) polymer prosthesis.
- 888.3180 Elbow joint humeral (hemi-elbow) metallic uncemented prosthesis.
- 888.3200 Finger joint metal/metal constrained uncemented prosthesis.

- 888.3210 Finger joint metal/metal constrained cemented prosthesis.
- 888.3220 Finger joint metal/polymer constrained cemented prosthesis.
- 888.3230 Finger joint polymer constrained prosthesis.
- 888.3300 Hip joint metal constrained cemented or uncemented prosthesis.
- 888.3310 Hip joint metal/polymer constrained cemented or uncemented prosthesis.
- 888.3320 Hip joint metal/metal semi-constrained, with a cemented acetabular component, prosthesis.
- 888.3330 Hip joint metal/metal semi-constrained, with an uncemented acetabular component, prosthesis.
- 888.3340 Hip joint metal/composite semi-constrained cemented prosthesis.
- 888.3350 Hip joint metal/polymer semi-constrained cemented prosthesis.
- 888.3353 Hip joint metal/ceramic/polymer semi-constrained cemented or nonporous uncemented prosthesis.
- 888.3358 Hip joint metal/polymer/metal semi-constrained porous-coated uncemented prosthesis.
- 888.3360 Hip joint femoral (hemi-hip) metallic cemented or uncemented prosthesis.
- 888.3370 Hip joint (hemi-hip) acetabular metal cemented prosthesis.
- 888.3380 Hip joint femoral (hemi-hip) trunion-bearing metal/polyacetal cemented prosthesis.
- 888.3390 Hip joint femoral (hemi-hip) metal/polymer cemented or uncemented prosthesis.
- 888.3400 Hip joint femoral (hemi-hip) metallic resurfacing prosthesis.
- 888.3410 Hip joint metal/polymer or ceramic/polymer semiconstrained resurfacing
- 888.3480 Knee joint femorotibial metallic constrained cemented prosthesis.
- 888.3490 Knee joint femorotibial metal/composite non-constrained cemented prosthesis.
- 888.3500 Knee joint femorotibial metal/composite semi-constrained cemented prosthesis.
- 888.3510 Knee joint femorotibial metal/polymer constrained cemented prosthesis.
- 888.3520 Knee joint femorotibial metal/polymer non-constrained cemented prosthesis.
- 888.3530 Knee joint femorotibial metal/polymer semi-constrained cemented prosthesis.
- 888.3535 Knee joint femorotibial (uni-compartmental) metal/polymer porous-coated uncemented prosthesis.
- 888.3540 Knee joint patellofemoral polymer/metal semi-constrained cemented prosthesis.
- 888.3550 Knee joint patellofemorotibial polymer/metal/metal constrained cemented prosthesis.



## Food and Drug Administration, HHS

## § 888.3

- 888.3560 Knee joint patellofemorotibial polymer/metal/polymer semi-constrained cemented prosthesis.
- 888.3565 Knee joint patellofemorotibial metal/polymer porous-coated uncemented prosthesis.
- 888.3570 Knee joint femoral (hemi-knee) metallic uncemented prosthesis.
- 888.3580 Knee joint patellar (hemi-knee) metallic resurfacing uncemented prosthesis.
- 888.3590 Knee joint tibial (hemi-knee) metallic resurfacing uncemented prosthesis.
- 888.3640 Shoulder joint metal/metal or metal/polymer constrained cemented prosthesis.
- 888.3650 Shoulder joint metal/polymer non-constrained cemented prosthesis.
- 888.3660 Shoulder joint metal/polymer semi-constrained cemented prosthesis.
- 888.3670 Shoulder joint metal/polymer/metal nonconstrained or semi-constrained porous-coated uncemented prosthesis.
- 888.3680 Shoulder joint glenoid (hemi-shoulder) metallic cemented prosthesis.
- 888.3690 Shoulder joint humeral (hemi-shoulder) metallic uncemented prosthesis.
- 888.3720 Toe joint polymer constrained prosthesis.
- 888.3730 Toe joint phalangeal (hemi-toe) polymer prosthesis.
- 888.3750 Wrist joint carpal lunate polymer prosthesis.
- 888.3760 Wrist joint carpal scaphoid polymer prosthesis.
- 888.3770 Wrist joint carpal trapezium polymer prosthesis.
- 888.3780 Wrist joint polymer constrained prosthesis.
- 888.3790 Wrist joint metal constrained cemented prosthesis.
- 888.3800 Wrist joint metal/polymer semi-constrained cemented prosthesis.
- 888.3810 Wrist joint ulnar (hemi-wrist) polymer prosthesis.

### Subpart E—Surgical Devices

- 888.4150 Calipers for clinical use.
- 888.4200 Cement dispenser.
- 888.4210 Cement mixer for clinical use.
- 888.4220 Cement monomer vapor evacuator.
- 888.4230 Cement ventilation tube.
- 888.4300 Depth gauge for clinical use.
- 888.4505 Orthopedic surgical instrumentation designed for osteochondral implants with press-fit fixation.
- 888.4540 Orthopedic manual surgical instrument.
- 888.4580 Sonic surgical instrument and accessories/attachments.
- 888.4600 Protractor for clinical use.
- 888.4800 Template for clinical use.
- 888.5850 Nonpowered orthopedic traction apparatus and accessories.
- 888.5890 Noninvasive traction component.
- 888.5940 Cast component.

- 888.5960 Cast removal instrument.
- 888.5980 Manual cast application and removal instrument.

AUTHORITY: 21 U.S.C. 351, 360, 360c, 360e, 360j, 360l, 371.

SOURCE: 52 FR 33702, Sept. 4, 1987, unless otherwise noted.

EDITORIAL NOTE: Nomenclature changes to part 888 appear at 73 FR 35341, June 23, 2008.

## Subpart A—General Provisions

### § 888.1 Scope.

(a) This part sets forth the classification of orthopedic devices intended for human use that are in commercial distribution.

(b) The identification of a device in a regulation in this part is not a precise description of every device that is, or will be, subject to the regulation. A manufacturer who submits a pre-market notification submission for a device under part 807 cannot show merely that the device is accurately described by the section title and identification provision of a regulation in this part, but shall state why the device is substantially equivalent to other devices, as required by § 807.87.

(c) To avoid duplicative listings, an orthopedic device that has two or more types of uses (e.g., used both as a diagnostic device and as a surgical device) is listed in one subpart only.

(d) References in this part to regulatory sections of the Code of Federal Regulations are to chapter I of title 21 unless otherwise noted.

(e) Guidance documents referenced in this part are available on the Internet at <http://www.fda.gov/MedicalDevices/DeviceRegulationandGuidance/GuidanceDocuments/default.htm>.

[52 FR 33702, Sept. 4, 1987, as amended at 68 FR 14137, Mar. 24, 2003; 78 FR 18233, Mar. 26, 2013]

### § 888.3 Effective dates of requirement for premarket approval.

A device included in this part that is classified into class III (premarket approval) shall not be commercially distributed after the date shown in the regulation classifying the device unless the manufacturer has an approval under section 515 of the act (unless an

exemption has been granted under section 520(g)(2) of the act). An approval under section 515 of the act consists of FDA's issuance of an order approving an application for premarket approval (PMA) for the device or declaring completed a product development protocol (PDP) for the device.

(a) Before FDA requires that a device commercially distributed before the enactment date of the amendments, or a device that has been found substantially equivalent to such a device, has an approval under section 515 of the act, FDA must promulgate a regulation under section 515(b) of the act requiring such approval, except as provided in paragraphs (b) and (c) of this section. Such a regulation under section 515(b) of the act shall not be effective during the grace period ending on the 90th day after its promulgation or on the last day of the 30th full calendar month after the regulation that classifies the device into class III is effective, whichever is later. See section 501(f)(2)(B) of the act. Accordingly, unless an effective date of the requirement for premarket approval is shown in the regulation for a device classified into class III in this part, the device may be commercially distributed without FDA's issuance of an order approving a PMA or declaring completed a PDP for the device. If FDA promulgates a regulation under section 515(b) of the act requiring premarket approval for a device, section 501(f)(1)(A) of the act applies to the device.

(b) Any new, not substantially equivalent, device introduced into commercial distribution on or after May 28, 1976, including a device formerly marketed that has been substantially altered, is classified by statute (section 513(f) of the act) into class III without any grace period and FDA must have issued an order approving a PMA or declaring completed a PDP for the device before the device is commercially distributed unless it is reclassified. If FDA knows that a device being commercially distributed may be a "new" device as defined in this section because of any new intended use or other reasons, FDA may codify the statutory classification of the device into class III for such new use. Accordingly, the regulation for such a class III device

states that as of the enactment date of the amendments, May 28, 1976, the device must have an approval under section 515 of the act before commercial distribution.

(c) A device identified in a regulation in this part that is classified into class III and that is subject to the transitional provisions of section 520(1) of the act is automatically classified by statute into class III and must have an approval under section 515 of the act before being commercially distributed. Accordingly, the regulation for such a class III transitional device states that as of the enactment date of the amendments, May 28, 1976, the device must have an approval under section 515 of the act before commercial distribution.

#### § 888.5 Resurfacing technique.

Because of resurfacing techniques, certain joint prostheses require far less bone resection than other devices intended to repair or replace the same joint. The amount of bone resection may or may not affect the safety and effectiveness of the implantation of the prosthesis. When a resurfacing technique is used, the name of the prosthesis includes this information.

#### § 888.6 Degree of constraint.

Certain joint prostheses provide more constraint of joint movement than others. FDA believes that the degree of constraint is an important factor affecting the safety and effectiveness of orthopedic prostheses. FDA is defining the following standard terms for categorizing the degree of constraint.

(a) A "constrained" joint prosthesis is used for joint replacement and prevents dislocation of the prosthesis in more than one anatomic plane and consists of either a single, flexible, across-the-joint component or more than one component linked together or affixed.

(b) A "semi-constrained" joint prosthesis is used for partial or total joint replacement and limits translation and rotation of the prosthesis in one or more planes via the geometry of its articulating surfaces. It has no across-the-joint linkage.

(c) A "non-constrained" joint prosthesis is used for partial or total joint replacement and restricts minimally prosthesis movement in one or more

planes. Its components have no across-the-joint linkage.

**§ 888.9 Limitations of exemptions from section 510(k) of the Federal Food, Drug, and Cosmetic Act (the act).**

The exemption from the requirement of premarket notification (section 510(k) of the act) for a generic type of class I or II device is only to the extent that the device has existing or reasonably foreseeable characteristics of commercially distributed devices within that generic type or, in the case of in vitro diagnostic devices, only to the extent that misdiagnosis as a result of using the device would not be associated with high morbidity or mortality. Accordingly, manufacturers of any commercially distributed class I or II device for which FDA has granted an exemption from the requirement of premarket notification must still submit a premarket notification to FDA before introducing or delivering for introduction into interstate commerce for commercial distribution the device when:

(a) The device is intended for a use different from the intended use of a legally marketed device in that generic type of device; e.g., the device is intended for a different medical purpose, or the device is intended for lay use where the former intended use was by health care professionals only;

(b) The modified device operates using a different fundamental scientific technology than a legally marketed device in that generic type of device; e.g., a surgical instrument cuts tissue with a laser beam rather than with a sharpened metal blade, or an in vitro diagnostic device detects or identifies infectious agents by using deoxyribonucleic acid (DNA) probe or nucleic acid hybridization technology rather than culture or immunoassay technology; or

(c) The device is an in vitro device that is intended:

(1) For use in the diagnosis, monitoring, or screening of neoplastic diseases with the exception of immunohistochemical devices;

(2) For use in screening or diagnosis of familial or acquired genetic disorders, including inborn errors of metabolism;

(3) For measuring an analyte that serves as a surrogate marker for screening, diagnosis, or monitoring life-threatening diseases such as acquired immune deficiency syndrome (AIDS), chronic or active hepatitis, tuberculosis, or myocardial infarction or to monitor therapy;

(4) For assessing the risk of cardiovascular diseases;

(5) For use in diabetes management;

(6) For identifying or inferring the identity of a microorganism directly from clinical material;

(7) For detection of antibodies to microorganisms other than immunoglobulin G (IgG) or IgG assays when the results are not qualitative, or are used to determine immunity, or the assay is intended for use in matrices other than serum or plasma;

(8) For noninvasive testing as defined in § 812.3(k) of this chapter; and

(9) For near patient testing (point of care).

[65 FR 2321, Jan. 14, 2000]

**Subpart B—Diagnostic Devices**

**§ 888.1100 Arthroscope.**

(a) *Identification.* An arthroscope is an electrically powered endoscope intended to make visible the interior of a joint. The arthroscope and accessories also is intended to perform surgery within a joint.

(b) *Classification.* (1) Class II (performance standards).

(2) Class I for the following manual arthroscopic instruments: cannulas, currettes, drill guides, forceps, gouges, graspers, knives, obturators, osteotomes, probes, punches, rasps, retractors, rongeurs, suture passers, suture knotpushers, suture punches, switching rods, and trocars. The devices subject to this paragraph (b)(2) are exempt from the premarket notification procedures in subpart E of part 807 of this chapter, subject to the limitations in § 888.9.

[52 FR 33702, Sept. 4, 1987, as amended at 61 FR 1124, Jan. 16, 1996; 66 FR 38815, July 25, 2001]

**§ 888.1240**

**21 CFR Ch. I (4–1–20 Edition)**

**§ 888.1240 AC-powered dynamometer.**

(a) *Identification.* An AC-powered dynamometer is an AC-powered device intended for medical purposes to assess neuromuscular function or degree of neuromuscular blockage by measuring, with a force transducer (a device that translates force into electrical impulses), the grip-strength of a patient's hand.

(b) *Classification.* Class II (special controls). The device is exempt from the premarket notification procedures in subpart E of part 807 of this chapter subject to the limitations in § 886.9.

[52 FR 33702, Sept. 4, 1987, as amended at 84 FR 71818, Dec. 30, 2019]

**§ 888.1250 Nonpowered dynamometer.**

(a) *Identification.* A nonpowered dynamometer is a mechanical device intended for medical purposes to measure the pinch and grip muscle strength of a patient's hand.

(b) *Classification.* Class I. The device is exempt from the premarket notification procedures in subpart E of part 807.

**§ 888.1500 Goniometer.**

(a) *Identification.* A goniometer is an AC-powered or battery powered device intended to evaluate joint function by measuring and recording ranges of motion, acceleration, or forces exerted by a joint.

(b) *Classification.* (1) Class I (general controls) for a goniometer that does not use electrode lead wires and patient cables. This device is exempt from the premarket notification procedures of subpart E of part 807 of this chapter subject to § 888.9.

(2) Class II (special controls) for a goniometer that uses electrode lead wires and patient cables. The special controls consist of:

(i) The performance standard under part 898 of this chapter, and

(ii) The guidance entitled "Guidance on the Performance Standard for Electrode Lead Wires and Patient Cables." This device is exempt from the premarket notification procedures of subpart E of part 807 of this chapter subject to § 888.9.

[65 FR 19319, Apr. 11, 2000]

**§ 888.1520 Nonpowered goniometer.**

(a) *Identification.* A nonpowered goniometer is a mechanical device intended for medical purposes to measure the range of motion of joints.

(b) *Classification.* Class I (general controls). The device is exempt from the premarket notification procedures in subpart E of part 807 of this chapter, subject to the limitations in § 888.9.

[52 FR 33702, Sept. 4, 1987, as amended at 66 FR 38815, July 25, 2001]

**Subpart C [Reserved]**

**Subpart D—Prosthetic Devices**

**§ 888.3000 Bone cap.**

(a) *Identification.* A bone cap is a mushroom-shaped device intended to be implanted made of either silicone elastomer or ultra-high molecular weight polyethylene. It is used to cover the severed end of a long bone, such as the humerus or tibia, to control bone overgrowth in juvenile amputees.

(b) *Classification.* Class I (general controls). The device is exempt from the premarket notification procedures in subpart E of part 807 of this chapter, subject to the limitations in § 888.9.

[52 FR 33702, Sept. 4, 1987, as amended at 61 FR 1124, Jan. 16, 1996; 66 FR 38815, July 25, 2001]

**§ 888.3010 Bone fixation cerclage.**

(a) *Identification.* A bone fixation cerclage is a device intended to be implanted that is made of alloys, such as cobalt-chromium-molybdenum, and that consists of a metallic ribbon or flat sheet or a wire. The device is wrapped around the shaft of a long bone, anchored to the bone with wire or screws, and used in the fixation of fractures.

(b) *Classification.* Class II.

**§ 888.3015 Bone heterograft.**

(a) *Identification.* Bone heterograft is a device intended to be implanted that is made from mature (adult) bovine bones and used to replace human bone following surgery in the cervical region of the spinal column.

(b) *Classification.* Class III.

(c) *Date PMA or notice of completion of a PDP is required.* As of May 28, 1976, an approval under section 515 of the act is required before this device may be commercially distributed. See § 888.3.

**§ 888.3020 Intramedullary fixation rod.**

(a) *Identification.* An intramedullary fixation rod is a device intended to be implanted that consists of a rod made of alloys such as cobalt-chromium-molybdenum and stainless steel. It is inserted into the medullary (bone marrow) canal of long bones for the fixation of fractures.

(b) *Classification.* Class II.

**§ 888.3023 In vivo cured intramedullary fixation rod.**

(a) *Identification.* An in vivo cured intramedullary fixation rod is a prescription implanted device consisting of a balloon that is inserted into the medullary canal of long bones for the fixation of fractures. The balloon is infused with, and completely encapsulates, a liquid monomer that is exposed to a curing agent which polymerizes the monomer within the balloon creating a hardened rigid structure.

(b) *Classification.* Class II (special controls). The special controls for this device are:

(1) Non-clinical performance testing must demonstrate that the device performs as intended under anticipated conditions of use. The following performance characteristics must be tested:

(i) Mechanical testing must be conducted on the final device to assess burst, abrasion, bending, and torsion in static and dynamic conditions.

(ii) Mechanical testing must demonstrate the integrity of the balloon including testing for leaks, ruptures, and release of cured/uncured material.

(iii) Performance testing must demonstrate that the device can be inserted and removed.

(iv) Performance testing must demonstrate the ability, in the event of a leak, to remove the uncured material from its in vivo location.

(v) Performance testing must demonstrate the reliability and accuracy of the curing method used.

(vi) Thermal safety testing must be conducted to evaluate the temperature rise during curing.

(2) Electrical safety, electromagnetic compatibility (EMC) testing, and electromagnetic interference (EMI) testing must be conducted for all electrical components.

(3) All patient-contacting components must be demonstrated to be bio-compatible.

(4) Performance data must demonstrate the sterility and pyrogenicity of patient contacting components of the device that are provided sterile.

(5) Performance data must validate the reprocessing instructions for any reusable components or instruments.

(6) Performance data must support the shelf life of the system by demonstrating continued sterility, package integrity, and system functionality over the established shelf life.

(7) Technological characterization of the device must include materials, curing agents, and a description of the operating principles of the device, including the delivery system and devices which initiate the curing process.

(8) Labeling must include the following:

(i) A detailed summary of the device technical parameters.

(ii) Information describing all materials of the device.

(iii) Information describing how to perform the procedure and use the device, including the delivery system and devices which initiate the curing process, as well as how to remove the device and any uncured materials.

(iv) A shelf life.

(v) Validated methods and instructions for reprocessing any reusable components or instruments.

[83 FR 26759, June 8, 2018]

**§ 888.3025 Passive tendon prosthesis.**

(a) *Identification.* A passive tendon prosthesis is a device intended to be implanted made of silicon elastomer or a polyester reinforced medical grade silicone elastomer intended for use in the surgical reconstruction of a flexor tendon of the hand. The device is implanted for a period of 2 to 6 months to aid growth of a new tendon sheath. The device is not intended as a permanent

**§ 888.3027**

implant nor to function as a replacement for the ligament or tendon nor to function as a scaffold for soft tissue ingrowth.

(b) *Classification.* Class II.

**§ 888.3027 Polymethylmethacrylate (PMMA) bone cement.**

(a) *Identification.* Polymethylmethacrylate (PMMA) bone cement is a device intended to be implanted that is made from methylmethacrylate, polymethylmethacrylate, esters of methacrylic acid, or copolymers containing polymethylmethacrylate and polystyrene. The device is intended for use in arthroplastic procedures of the hip, knee, and other joints for the fixation of polymer or metallic prosthetic implants to living bone.

(b) *Classification.* Class II (special controls). The special control for this device is the FDA guidance document entitled "Class II Special Controls Guidance Document: Polymethylmethacrylate (PMMA) Bone Cement."

[67 FR 46855, July 17, 2002]

**§ 888.3030 Single/multiple component metallic bone fixation appliances and accessories.**

(a) *Identification.* Single/multiple component metallic bone fixation appliances and accessories are devices intended to be implanted consisting of one or more metallic components and their metallic fasteners. The devices contain a plate, a nail/plate combination, or a blade/plate combination that are made of alloys, such as cobalt-chromium-molybdenum, stainless steel, and titanium, that are intended to be held in position with fasteners, such as screws and nails, or bolts, nuts, and washers. These devices are used for fixation of fractures of the proximal or distal end of long bones, such as intracapsular, intertrochanteric, inter-cervical, supracondylar, or condylar fractures of the femur; for fusion of a joint; or for surgical procedures that involve cutting a bone. The devices may be implanted or attached through the skin so that a pulling force (traction) may be applied to the skeletal system.

(b) *Classification.* Class II.

**21 CFR Ch. I (4-1-20 Edition)**

**§ 888.3040 Smooth or threaded metallic bone fixation fastener.**

(a) *Identification.* A smooth or threaded metallic bone fixation fastener is a device intended to be implanted that consists of a stiff wire segment or rod made of alloys, such as cobalt-chromium-molybdenum and stainless steel, and that may be smooth on the outside, fully or partially threaded, straight or U-shaped; and may be either blunt pointed, sharp pointed, or have a formed, slotted head on the end. It may be used for fixation of bone fractures, for bone reconstructions, as a guide pin for insertion of other implants, or it may be implanted through the skin so that a pulling force (traction) may be applied to the skeletal system.

(b) *Classification.* Class II.

**§ 888.3045 Resorbable calcium salt bone void filler device.**

(a) *Identification.* A resorbable calcium salt bone void filler device is a resorbable implant intended to fill bony voids or gaps of the extremities, spine, and pelvis that are caused by trauma or surgery and are not intrinsic to the stability of the bony structure.

(b) *Classification.* Class II (special controls). The special control for this device is the FDA guidance document entitled "Class II Special Controls Guidance: Resorbable Calcium Salt Bone Void Filler Device; Guidance for Industry and FDA." See § 888.1(e) of this chapter for the availability of this guidance.

[68 FR 32636, June 2, 2003]

**§ 888.3050 Spinal interlaminar fixation orthosis.**

(a) *Identification.* A spinal interlaminar fixation orthosis is a device intended to be implanted made of an alloy, such as stainless steel, that consists of various hooks and a posteriorly placed compression or distraction rod. The device is implanted, usually across three adjacent vertebrae, to straighten and immobilize the spine to allow bone grafts to unite and fuse the vertebrae together. The device is used primarily in the treatment of scoliosis (a lateral curvature of the spine), but it also may be used in the treatment of fracture or

dislocation of the spine, grades 3 and 4 of spondylolisthesis (a dislocation of the spinal column), and lower back syndrome.

(b) *Classification*. Class II.

**§ 888.3060 Spinal intervertebral body fixation orthosis.**

(a) *Identification*. A spinal intervertebral body fixation orthosis is a device intended to be implanted made of titanium. It consists of various vertebral plates that are punched into each of a series of vertebral bodies. An eye-type screw is inserted in a hole in the center of each of the plates. A braided cable is threaded through each eye-type screw. The cable is tightened with a tension device and it is fastened or crimped at each eye-type screw. The device is used to apply force to a series of vertebrae to correct "sway back," scoliosis (lateral curvature of the spine), or other conditions.

(b) *Classification*. Class II.

**§ 888.3070 Thoracolumbosacral pedicle screw system.**

(a) *Identification*. (1) Rigid pedicle screw systems are comprised of multiple components, made from a variety of materials that allow the surgeon to build an implant system to fit the patient's anatomical and physiological requirements. Such a spinal implant assembly consists of a combination of screws, longitudinal members (*e.g.*, plates, rods including dual diameter rods, plate/rod combinations), transverse or cross connectors, and interconnection mechanisms (*e.g.*, rod-to-rod connectors, offset connectors).

(2) Semi-rigid systems are defined as systems that contain one or more of the following features (including but not limited to): Non-uniform longitudinal elements, or features that allow more motion or flexibility compared to rigid systems.

(b) *Classification*. (1) Class II (special controls), when intended to provide immobilization and stabilization of spinal segments in skeletally mature patients as an adjunct to fusion in the treatment of the following acute and chronic instabilities or deformities of the thoracic, lumbar, and sacral spine: severe spondylolisthesis (grades 3 and 4) of the L5-S1 vertebra; degenerative

spondylolisthesis with objective evidence of neurologic impairment; fracture; dislocation; scoliosis; kyphosis; spinal tumor; and failed previous fusion (pseudarthrosis). These pedicle screw spinal systems must comply with the following special controls:

- (i) Compliance with material standards;
- (ii) Compliance with mechanical testing standards;
- (iii) Compliance with biocompatibility standards; and
- (iv) Labeling that contains these two statements in addition to other appropriate labeling information:

"Warning: The safety and effectiveness of pedicle screw spinal systems have been established only for spinal conditions with significant mechanical instability or deformity requiring fusion with instrumentation. These conditions are significant mechanical instability or deformity of the thoracic, lumbar, and sacral spine secondary to severe spondylolisthesis (grades 3 and 4) of the L5-S1 vertebra, degenerative spondylolisthesis with objective evidence of neurologic impairment, fracture, dislocation, scoliosis, kyphosis, spinal tumor, and failed previous fusion (pseudarthrosis). The safety and effectiveness of these devices for any other conditions are unknown."

"Precaution: The implantation of pedicle screw spinal systems should be performed only by experienced spinal surgeons with specific training in the use of this pedicle screw spinal system because this is a technically demanding procedure presenting a risk of serious injury to the patient."

(2) Class II (special controls), when a rigid pedicle screw system is intended to provide immobilization and stabilization of spinal segments in the thoracic, lumbar, and sacral spine as an adjunct to fusion in the treatment of degenerative disc disease and spondylolisthesis other than either severe spondylolisthesis (grades 3 and 4) at L5-S1 or degenerative spondylolisthesis with objective evidence of neurologic impairment. These pedicle screw systems must comply with the following special controls:

- (i) The design characteristics of the device, including engineering schematics, must ensure that the geometry and material composition are consistent with the intended use.
- (ii) Non-clinical performance testing must demonstrate the mechanical function and durability of the implant.

(iii) Device components must be demonstrated to be biocompatible.

(iv) Validation testing must demonstrate the cleanliness and sterility of, or the ability to clean and sterilize, the device components and device-specific instruments.

(v) Labeling must include the following:

(A) A clear description of the technological features of the device including identification of device materials and the principles of device operation;

(B) Intended use and indications for use, including levels of fixation;

(C) Identification of magnetic resonance (MR) compatibility status;

(D) Cleaning and sterilization instructions for devices and instruments that are provided non-sterile to the end user; and

(E) Detailed instructions of each surgical step, including device removal.

(3) Class II (special controls), when a semi-rigid system is intended to provide immobilization and stabilization of spinal segments in the thoracic, lumbar, and sacral spine as an adjunct to fusion for any indication. In addition to complying with the special controls in paragraphs (b)(2)(i) through (v) of this section, these pedicle screw systems must comply with the following special controls:

(i) Demonstration that clinical performance characteristics of the device support the intended use of the product, including assessment of fusion compared to a clinically acceptable fusion rate.

(ii) Semi-rigid systems marketed prior to the effective date of this reclassification must submit an amendment to their previously cleared premarket notification (510(k)) demonstrating compliance with the special controls in paragraphs (b)(2)(i) through (v) and paragraph (b)(3)(i) of this section.

[66 FR 28053, May 22, 2001, as amended at 81 FR 96373, Dec. 30, 2016]

**§ 888.3075 Posterior cervical screw system.**

(a) *Identification.* Posterior cervical screw systems are comprised of multiple, interconnecting components, made from a variety of materials that allow an implant system to be built

from the occiput to the upper thoracic spine to fit the patient's anatomical and physiological requirements, as determined by preoperative cross-sectional imaging. Such a spinal assembly consists of a combination of bone anchors via screws (*i.e.*, occipital screws, cervical lateral mass screws, cervical pedicle screws, C2 pars screws, C2 translaminar screws, C2 transarticular screws), longitudinal members (*e.g.*, plates, rods, including dual diameter rods, plate/rod combinations), transverse or cross connectors, interconnection mechanisms (*e.g.*, rod-to-rod connectors, offset connectors), and closure mechanisms (*e.g.*, set screws, nuts). Posterior cervical screw systems are rigidly fixed devices that do not contain dynamic features, including but not limited to: non-uniform longitudinal elements or features that allow more motion or flexibility compared to rigid systems.

Posterior cervical screw systems are intended to provide immobilization and stabilization of spinal segments in patients as an adjunct to fusion for acute and chronic instabilities of the cervical spine and/or craniocervical junction and/or cervicothoracic junction such as: (1) Traumatic spinal fractures and/or traumatic dislocations; (2) deformities; (3) instabilities; (4) failed previous fusions (*e.g.*, pseudarthrosis); (5) tumors; (6) inflammatory disorders; (7) spinal degeneration, including neck and/or arm pain of discogenic origin as confirmed by imaging studies (radiographs, CT, MRI); (8) degeneration of the facets with instability; and (9) reconstruction following decompression to treat radiculopathy and/or myelopathy. These systems are also intended to restore the integrity of the spinal column even in the absence of fusion for a limited time period in patients with advanced stage tumors involving the cervical spine in whom life expectancy is of insufficient duration to permit achievement of fusion.

(b) *Classification.* Class II (special controls). The special controls for posterior cervical screw systems are:

(1) The design characteristics of the device, including engineering schematics, must ensure that the geometry and material composition are consistent with the intended use.



(2) Nonclinical performance testing must demonstrate the mechanical function and durability of the implant.

(3) Device components must be demonstrated to be biocompatible.

(4) Validation testing must demonstrate the cleanliness and sterility of, or the ability to clean and sterilize, the device components and device-specific instruments.

(5) Labeling must include the following:

(i) A clear description of the technological features of the device including identification of device materials and the principles of device operation;

(ii) Intended use and indications for use including levels of fixation;

(iii) Device specific warnings, precautions, and contraindications that include the following statements:

(A) "Precaution: Preoperative planning prior to implantation of posterior cervical screw systems should include review of cross-sectional imaging studies (e.g., CT and/or MRI) to evaluate the patient's cervical anatomy including the transverse foramen, neurologic structures, and the course of the vertebral arteries. If any findings would compromise the placement of these screws, other surgical methods should be considered. In addition, use of intraoperative imaging should be considered to guide and/or verify device placement, as necessary."

(B) "Precaution: Use of posterior cervical pedicle screw fixation at the C3 through C6 spinal levels requires careful consideration and planning beyond that required for lateral mass screws placed at these spinal levels, given the proximity of the vertebral arteries and neurologic structures in relation to the cervical pedicles at these levels."

(iv) Identification of magnetic resonance (MR) compatibility status;

(v) Cleaning and sterilization instructions for devices and instruments that are provided non-sterile to the end user, and;

(vi) Detailed instructions of each surgical step, including device removal.

[84 FR 12092, Apr. 1, 2019]

**§ 888.3080 Intervertebral body fusion device.**

(a) *Identification.* An intervertebral body fusion device is an implanted sin-

gle or multiple component spinal device made from a variety of materials, including titanium and polymers. The device is inserted into the intervertebral body space of the cervical or lumbosacral spine, and is intended for intervertebral body fusion.

(b) *Classification.* (1) Class II (special controls) for intervertebral body fusion devices that contain bone grafting material. The special control is the FDA guidance document entitled "Class II Special Controls Guidance Document: Intervertebral Body Fusion Device." See § 888.1(e) for the availability of this guidance document.

(2) Class III (premarket approval) for intervertebral body fusion devices that include any therapeutic biologic (e.g., bone morphogenic protein). Intervertebral body fusion devices that contain any therapeutic biologic require premarket approval.

(c) *Date premarket approval application (PMA) or notice of product development protocol (PDP) is required.* Devices described in paragraph (b)(2) of this section shall have an approved PMA or a declared completed PDP in effect before being placed in commercial distribution.

[72 FR 32172, June 12, 2007]

**§ 888.3100 Ankle joint metal/composite semi-constrained cemented prosthesis.**

(a) *Identification.* An ankle joint metal/composite semi-constrained cemented prosthesis is a device intended to be implanted to replace an ankle joint. The device limits translation and rotation: in one or more planes via the geometry of its articulating surfaces. It has no linkage across-the-joint. This generic type of device includes prostheses that consist of a talar resurfacing component made of alloys, such as cobalt-chromium-molybdenum, and a tibial resurfacing component fabricated from ultra-high molecular weight polyethylene with carbon fibers composite, and is limited to those prostheses intended for use with bone cement (§ 888.3027).

(b) *Classification.* Class II.

**§ 888.3110**

**21 CFR Ch. I (4-1-20 Edition)**

**§ 888.3110 Ankle joint metal/polymer semi-constrained cemented prosthesis.**

(a) *Identification.* An ankle joint metal/polymer semi-constrained cemented prosthesis is a device intended to be implanted to replace an ankle joint. The device limits translation and rotation in one or more planes via the geometry of its articulating surfaces and has no linkage across-the-joint. This generic type of device includes prostheses that have a talar resurfacing component made of alloys, such as cobalt-chromium-molybdenum, and a tibial resurfacing component made of ultra-high molecular weight polyethylene and is limited to those prostheses intended for use with bone cement (§ 888.3027).

(b) *Classification.* Class II.

**§ 888.3120 Ankle joint metal/polymer non-constrained cemented prosthesis.**

(a) *Identification.* An ankle joint metal/polymer non-constrained cemented prosthesis is a device intended to be implanted to replace an ankle joint. The device limits minimally (less than normal anatomic constraints) translation in one or more planes. It has no linkage across-the-joint. This generic type of device includes prostheses that have a tibial component made of alloys, such as cobalt-chromium-molybdenum, and a talar component made of ultra-high molecular weight polyethylene, and is limited to those prostheses intended for use with bone cement (§ 888.3027).

(b) *Classification.* Class III.

(c) *Date PMA or notice of completion of a PDP is required.* A PMA or a notice of completion of a PDP is required to be filed with the Food and Drug Administration on or before December 26, 1996 for any ankle joint metal/polymer non-constrained cemented prosthesis that was in commercial distribution before May 28, 1976, or that has, on or before December 26, 1996, been found to be substantially equivalent to an ankle joint metal/polymer non-constrained cemented prosthesis that was in commercial distribution before May 28, 1976. Any other ankle joint metal/polymer non-constrained cemented prosthesis shall have an approved PMA or a

declared completed PDP in effect before being placed in commercial distribution.

[52 FR 33702, Sept. 4, 1987, as amended at 61 FR 50709, Sept. 27, 1996]

**§ 888.3150 Elbow joint metal/polymer constrained cemented prosthesis.**

(a) *Identification.* An elbow joint metal/polymer constrained cemented prosthesis is a device intended to be implanted to replace an elbow joint. It is made of alloys, such as cobalt-chromium-molybdenum, or of these alloys and of an ultra-high molecular weight polyethylene bushing. The device prevents dislocation in more than one anatomic plane and consists of two components that are linked together. This generic type of device is limited to those prostheses intended for use with bone cement (§ 888.3027).

(b) *Classification.* Class II. The special controls for this device are:

(1) FDA's:

(i) "Use of International Standard ISO 10993 'Biological Evaluation of Medical Devices—Part I: Evaluation and Testing,'" "

(ii) "510(k) Sterility Review Guidance of 2/12/90 (K90-1)," "

(iii) "Guidance Document for Testing Orthopedic Implants with Modified Metallic Surfaces Apposing Bone or Bone Cement," "

(iv) "Guidance Document for the Preparation of Premarket Notification (510(k)) Application for Orthopedic Devices," "

(v) "Guidance Document for Testing Non-articulating, 'Mechanically Locked' Modular Implant Components," "

(2) International Organization for Standardization's (ISO):

(i) ISO 5832-3:1996 "Implants for Surgery—Metallic Materials—Part 3: Wrought Titanium 6-Aluminum 4-Vandium Alloy," "

(ii) ISO 5832-4:1996 "Implants for Surgery—Metallic Materials—Part 4: Cobalt-Chromium-Molybdenum Casting Alloy," "

(iii) ISO 5832-12:1996 "Implants for Surgery—Metallic Materials—Part 12: Wrought Cobalt-Chromium-Molybdenum Alloy," "

(iv) ISO 5833:1992 "Implants for Surgery—Acrylic Resin Cements," "

(v) ISO 5834-2:1998 “Implants for Surgery—Ultra High Molecular Weight Polyethylene—Part 2: Moulded Forms,”

(vi) ISO 6018:1987 “Orthopaedic Implants—General Requirements for Marking, Packaging, and Labeling,”

(vii) ISO 9001:1994 “Quality Systems—Model for Quality Assurance in Design/Development, Production, Installation, and Servicing,” and

(viii) ISO 14630:1997 “Non-active Surgical Implants—General Requirements,”

(3) American Society for Testing and Materials’:

(i) F 75-92 “Specification for Cast Cobalt-28 Chromium-6 Molybdenum Alloy for Surgical Implant Material,”

(ii) F 648-98 “Specification for Ultra-High-Molecular-Weight Polyethylene Powder and Fabricated Form for Surgical Implants,”

(iii) F 799-96 “Specification for Cobalt-28 Chromium-6 Molybdenum Alloy Forgings for Surgical Implants,”

(iv) F 981-93 “Practice for Assessment of Compatibility of Biomaterials (Nonporous) for Surgical Implant with Respect to Effect of Material on Muscle and Bone,”

(v) F 1044-95 “Test Method for Shear Testing of Porous Metal Coatings,”

(vi) F 1108-97 “Specification for Titanium-6 Aluminum-4 Vanadium Alloy Castings for Surgical Implants,”

(vii) F 1147-95 “Test Method for Tension Testing of Porous Metal Coatings,” and

(viii) F 1537-94 “Specification for Wrought Cobalt-28 Chromium-6 Molybdenum Alloy for Surgical Implants.”

[65 FR 17147, Mar. 31, 2000]

**§ 888.3160 Elbow joint metal/polymer semi-constrained cemented prosthesis.**

(a) *Identification.* An elbow joint metal/polymer semi-constrained cemented prosthesis is a device intended to be implanted to replace an elbow joint. The device limits translation and rotation in one or more planes via the geometry of its articulating surfaces. It has no linkage across-the-joint. This generic type of device includes prostheses that consist of a humeral resurfacing component made of alloys, such as cobalt-chromium-molybdenum, and

a radial resurfacing component made of ultra-high molecular weight polyethylene. This generic type of device is limited to those prostheses intended for use with bone cement (§ 888.3027).

(b) *Classification.* Class II.

**§ 888.3170 Elbow joint radial (hemi-elbow) polymer prosthesis.**

(a) *Identification.* An elbow joint radial (hemi-elbow) polymer prosthesis is a device intended to be implanted made of medical grade silicone elastomer used to replace the proximal end of the radius.

(b) *Classification.* Class II.

**§ 888.3180 Elbow joint humeral (hemi-elbow) metallic uncemented prosthesis.**

(a) *Identification.* An elbow joint humeral (hemi-elbow) metallic uncemented prosthesis is a device intended to be implanted made of alloys, such as cobalt-chromium-molybdenum, that is used to replace the distal end of the humerus formed by the trochlea humeri and the capitulum humeri. The generic type of device is limited to prostheses intended for use without bone cement (§ 888.3027).

(b) *Classification.* Class III.

(c) *Date PMA or notice of completion of a PDP is required.* A PMA or a notice of completion of a PDP is required to be filed with the Food and Drug Administration on or before December 26, 1996 for any elbow joint humeral (hemi-elbow) metallic uncemented prosthesis that was in commercial distribution before May 28, 1976, or that has, on or before December 26, 1996 been found to be substantially equivalent to an elbow joint humeral (hemi-elbow) metallic uncemented prosthesis that was in commercial distribution before May 28, 1976. Any other elbow joint humeral (hemi-elbow) metallic uncemented prosthesis shall have an approved PMA or a declared completed PDP in effect before being placed in commercial distribution.

[52 FR 33702, Sept. 4, 1987, as amended at 61 FR 50709, Sept. 27, 1996]

**§ 888.3200 Finger joint metal/metal constrained uncemented prosthesis.**

(a) *Identification.* A finger joint metal/metal constrained uncemented

**§ 888.3210**

prosthesis is a device intended to be implanted to replace a metacarpophalangeal or proximal interphalangeal (finger) joint. The device prevents dislocation in more than one anatomic plane and consists of two components which are linked together. This generic type of device includes prostheses made of alloys, such as cobalt-chromium-molybdenum, or prostheses made from alloys and ultra-high molecular weight polyethylene. This generic type of device is limited to prostheses intended for use without bone cement (§ 888.3027).

(b) *Classification.* Class III.

(c) *Date PMA or notice of completion of a PDP is required.* A PMA or a notice of completion of a PDP is required to be filed with the Food and Drug Administration on or before December 26, 1996 for any finger joint metal/metal constrained uncemented prosthesis that was in commercial distribution before May 28, 1976, or that has, on or before December 26, 1996 been found to be substantially equivalent to a finger joint metal/metal constrained uncemented prosthesis that was in commercial distribution before May 28, 1976. Any other finger joint metal/metal constrained uncemented prosthesis shall have an approved PMA or a declared completed PDP in effect before being placed in commercial distribution.

[52 FR 33702, Sept. 4, 1987, as amended at 61 FR 50709, Sept. 27, 1996]

**§ 888.3210 Finger joint metal/metal constrained cemented prosthesis.**

(a) *Identification.* A finger joint metal/metal constrained cemented prosthesis is a device intended to be implanted to replace a metacarpophalangeal (finger) joint. This device prevents dislocation in more than one anatomic plane and has components which are linked together. This generic type of device includes prostheses that are made of alloys, such as cobalt-chromium-molybdenum, and is limited to those prostheses intended for use with bone cement (§ 888.3027).

(b) *Classification.* Class III.

(c) *Date PMA or notice of completion of a PDP is required.* A PMA or a notice of completion of a PDP is required to be filed with the Food and Drug Adminis-

**21 CFR Ch. I (4-1-20 Edition)**

tration on or before December 26, 1996 for any finger joint metal/metal constrained cemented prosthesis that was in commercial distribution before May 28, 1976, or that has, on or before December 26, 1996 been found to be substantially equivalent to a finger joint metal/metal constrained cemented prosthesis that was in commercial distribution before May 28, 1976. Any other finger joint metal/metal constrained cemented prosthesis shall have an approved PMA or a declared completed PDP in effect before being placed in commercial distribution.

[52 FR 33702, Sept. 4, 1987, as amended at 61 FR 50709, Sept. 27, 1996]

**§ 888.3220 Finger joint metal/polymer constrained cemented prosthesis.**

(a) *Identification.* A finger joint metal/polymer constrained cemented prosthesis is a device intended to be implanted to replace a metacarpophalangeal or proximal interphalangeal (finger) joint. The device prevents dislocation in more than one anatomic plane, and consists of two components which are linked together. This generic type of device includes prostheses that are made of alloys, such as cobalt-chromium-molybdenum, and ultra-high molecular weight polyethylene, and is limited to those prostheses intended for use with bone cement (§ 888.3027).

(b) *Classification.* Class III.

(c) *Date PMA or notice of completion of a PDP is required.* A PMA or a notice of completion of a PDP is required to be filed with the Food and Drug Administration on or before December 26, 1996 for any finger joint metal/polymer constrained cemented prosthesis that was in commercial distribution before May 28, 1976, or that has, on or before December 26, 1996 been found to be substantially equivalent to a finger joint metal/polymer constrained cemented prosthesis that was in commercial distribution before May 28, 1976. Any other finger joint metal/polymer constrained cemented prosthesis shall have an approved PMA or a declared completed PDP in effect before being placed in commercial distribution.

[52 FR 33702, Sept. 4, 1987, as amended at 61 FR 50709, Sept. 27, 1996]

**§ 888.3230 Finger joint polymer constrained prosthesis.**

(a) *Identification.* A finger joint polymer constrained prosthesis is a device intended to be implanted to replace a metacarpophalangeal or proximal interphalangeal (finger) joint. This generic type of device includes prostheses that consist of a single flexible across-the-joint component made from either a silicone elastomer or a combination of polypropylene and polyester material. The flexible across-the-joint component may be covered with a silicone rubber sleeve.

(b) *Classification.* Class II.

**§ 888.3300 Hip joint metal constrained cemented or uncemented prosthesis.**

(a) *Identification.* A hip joint metal constrained cemented or uncemented prosthesis is a device intended to be implanted to replace a hip joint. The device prevents dislocation in more than one anatomic plane and has components that are linked together. This generic type of device includes prostheses that have components made of alloys, such as cobalt-chromium-molybdenum, and is intended for use with or without bone cement (§ 888.3027). This device is not intended for biological fixation.

(b) *Classification.* Class III.

(c) *Date PMA or notice of completion of a PDP is required.* A PMA or a notice of completion of a PDP is required to be filed with the Food and Drug Administration on or before December 26, 1996 for any hip joint metal constrained cemented or uncemented prosthesis that was in commercial distribution before May 28, 1976, or that has, on or before December 26, 1996 been found to be substantially equivalent to a hip joint metal constrained cemented or uncemented prosthesis that was in commercial distribution before May 28, 1976. Any other hip joint metal constrained cemented or uncemented prosthesis shall have an approved PMA or a declared completed PDP in effect before being placed in commercial distribution.

[52 FR 33702, Sept. 4, 1987, as amended at 61 FR 50709, Sept. 27, 1996]

**§ 888.3310 Hip joint metal/polymer constrained cemented or uncemented prosthesis.**

(a) *Identification.* A hip joint metal/polymer constrained cemented or uncemented prosthesis is a device intended to be implanted to replace a hip joint. The device prevents dislocation in more than one anatomic plane and has components that are linked together. This generic type of device includes prostheses that have a femoral component made of alloys, such as cobalt-chromium-molybdenum, and an acetabular component made of ultra-high-molecular-weight polyethylene with or without a metal shell, made of alloys, such as cobalt-chromium-molybdenum and titanium alloys. This generic type of device is intended for use with or without bone cement (§ 888.3027).

(b) *Classification.* Class II (special controls). The special control for this device is the FDA guidance document entitled “Class II Special Controls Guidance: Hip Joint Metal/Polymer Constrained Cemented or Uncemented Prosthesis.”

[67 FR 21173, Apr. 30, 2002]

**§ 888.3320 Hip joint metal/metal semi-constrained, with a cemented acetabular component, prosthesis.**

(a) *Identification.* A hip joint metal/metal semi-constrained, with a cemented acetabular component, prosthesis is a two-part device intended to be implanted to replace a hip joint. The device limits translation and rotation in one or more planes via the geometry of its articulating surfaces. It has no linkage across-the-joint. This generic type of device includes prostheses that consist of a femoral and an acetabular component, both made of alloys, such as cobalt-chromium-molybdenum. This generic type of device is limited to those prostheses intended for use with bone cement (§ 888.3027).

(b) *Classification.* Class III.

(c) *Date PMA or notice of completion of PDP is required.* A PMA or a notice of completion of a PDP is required to be filed with the Food and Drug Administration on or before May 18, 2016, for any hip joint metal/metal semi-constrained prosthesis with a cemented

## § 888.3330

acetabular component that was in commercial distribution before May 28, 1976, or that has, on or before May 18, 2016, been found to be substantially equivalent to a hip joint metal/metal semi-constrained prosthesis with a cemented acetabular component that was in commercial distribution before May 28, 1976. Any other hip joint metal/metal semi-constrained prosthesis with a cemented acetabular component shall have an approved PMA or a declared completed PDP in effect before being placed in commercial distribution.

[52 FR 33702, Sept. 4, 1987, as amended at 81 FR 8149, Feb. 18, 2016]

## § 888.3330 Hip joint metal/metal semi-constrained, with an uncemented acetabular component, prosthesis.

(a) *Identification.* A hip joint metal/metal semi-constrained, with an uncemented acetabular component, prosthesis is a two-part device intended to be implanted to replace a hip joint. The device limits translation and rotation in one or more planes via the geometry of its articulating surfaces. It has no linkage across-the-joint. This generic type of device includes prostheses that consist of a femoral and an acetabular component, both made of alloys, such as cobalt-chromium-molybdenum. The femoral component is intended to be fixed with bone cement. The acetabular component is intended for use without bone cement (§ 888.3027).

(b) *Classification.* Class III.

(c) *Date PMA or notice of completion of PDP is required.* A PMA or a notice of completion of a PDP is required to be filed with the Food and Drug Administration on or before May 18, 2016, for any hip joint metal/metal semi-constrained prosthesis with an uncemented acetabular component that was in commercial distribution before May 28, 1976, or that has, on or before May 18, 2016, been found to be substantially equivalent to a hip joint metal/metal semi-constrained prosthesis with an uncemented acetabular component that was in commercial distribution before May 28, 1976. Any other hip joint metal/metal semi-constrained prosthesis with an uncemented acetabular component shall have an approved PMA or a de-

## 21 CFR Ch. I (4-1-20 Edition)

clared completed PDP in effect before being placed in commercial distribution.

[52 FR 33702, Sept. 4, 1987, as amended at 81 FR 8149, Feb. 18, 2016]

## § 888.3340 Hip joint metal/composite semi-constrained cemented prosthesis.

(a) *Identification.* A hip joint metal/composite semi-constrained cemented prosthesis is a two-part device intended to be implanted to replace a hip joint. The device limits translation and rotation in one or more planes via the geometry of its articulating surfaces. It has no linkage across-the-joint. This generic type of device includes prostheses that consist of a femoral component made of alloys, such as cobalt-chromium-molybdenum, and an acetabular component made of ultra-high molecular weight polyethylene with carbon fibers composite. Both components are intended for use with bone cement (§ 888.3027).

(b) *Classification.* Class II.

## § 888.3350 Hip joint metal/polymer semi-constrained cemented prosthesis.

(a) *Identification.* A hip joint metal/polymer semi-constrained cemented prosthesis is a device intended to be implanted to replace a hip joint. The device limits translation and rotation in one or more planes via the geometry of its articulating surfaces. It has no linkage across-the-joint. This generic type of device includes prostheses that have a femoral component made of alloys, such as cobalt-chromium-molybdenum, and an acetabular resurfacing component made of ultra-high molecular weight polyethylene and is limited to those prostheses intended for use with bone cement (§ 888.3027).

(b) *Classification.* Class II.

## § 888.3353 Hip joint metal/ceramic/polymer semi-constrained cemented or nonporous uncemented prosthesis.

(a) *Identification.* A hip joint metal/ceramic/polymer semi-constrained cemented or nonporous uncemented prosthesis is a device intended to be implanted to replace a hip joint. This device limits translation and rotation in

one or more planes via the geometry of its articulating surfaces. It has no linkage across-the-joint. The two-part femoral component consists of a femoral stem made of alloys to be fixed in the intramedullary canal of the femur by impaction with or without use of bone cement. The proximal end of the femoral stem is tapered with a surface that ensures positive locking with the spherical ceramic (aluminium oxide, Al<sub>2</sub>O<sub>3</sub>) head of the femoral component. The acetabular component is made of ultra-high molecular weight polyethylene or ultra-high molecular weight polyethylene reinforced with nonporous metal alloys, and used with or without bone cement.

(b) *Classification.* Class II.

[54 FR 48239, Nov. 22, 1989; 54 FR 51342, Dec. 14, 1989]

**§ 888.3358 Hip joint metal/polymer/metal semi-constrained porous-coated uncemented prosthesis.**

(a) *Identification.* A hip joint metal/polymer/metal semi-constrained porous-coated uncemented prosthesis is a device intended to be implanted to replace a hip joint. The device limits translation and rotation in one or more planes via the geometry of its articulating surfaces. It has no linkage across the joint. This generic type of device has a femoral component made of a cobalt-chromium-molybdenum (Co-Cr-Mo) alloy or a titanium-aluminum-vanadium (Ti-6Al-4V) alloy and an acetabular component composed of an ultra-high molecular weight polyethylene articulating bearing surface fixed in a metal shell made of Co-Cr-Mo or Ti-6Al-4V. The femoral stem and acetabular shell have a porous coating made of, in the case of Co-Cr-Mo substrates, beads of the same alloy, and in the case of Ti-6Al-4V substrates, fibers of commercially pure titanium or Ti-6Al-4V alloy. The porous coating has a volume porosity between 30 and 70 percent, an average pore size between 100 and 1,000 microns, interconnecting porosity, and a porous coating thickness between 500 and 1,500 microns. The generic type of device has a design to achieve biological fixation to bone without the use of bone cement.

(b) *Classification.* Class II.

[58 FR 3228, Jan. 8, 1993]

**§ 888.3360 Hip joint femoral (hemi-hip) metallic cemented or uncemented prosthesis.**

(a) *Identification.* A hip joint femoral (hemi-hip) metallic cemented or uncemented prosthesis is a device intended to be implanted to replace a portion of the hip joint. This generic type of device includes prostheses that have a femoral component made of alloys, such as cobalt-chromium-molybdenum. This generic type of device includes designs which are intended to be fixed to the bone with bone cement (§888.3027) as well as designs which have large window-like holes in the stem of the device and which are intended for use without bone cement. However, in these latter designs, fixation of the device is not achieved by means of bone ingrowth.

(b) *Classification.* Class II.

**§ 888.3370 Hip joint (hemi-hip) acetabular metal cemented prosthesis.**

(a) *Identification.* A hip joint (hemi-hip) acetabular metal cemented prosthesis is a device intended to be implanted to replace a portion of the hip joint. This generic type of device includes prostheses that have an acetabular component made of alloys, such as cobalt-chromium-molybdenum. This generic type of device is limited to those prostheses intended for use with bone cement (§888.3027).

(b) *Classification.* Class III.

(c) *Date PMA or notice of completion of a PDP is required.* A PMA or a notice of completion of a PDP is required to be filed with the Food and Drug Administration on or before December 26, 1996 for any hip joint (hemi-hip) acetabular metal cemented prosthesis that was in commercial distribution before May 28, 1976, or that has, on or before December 26, 1996 been found to be substantially equivalent to a hip joint (hemi-hip) acetabular metal cemented prosthesis that was in commercial distribution before May 28, 1976. Any other hip joint metal (hemi-hip) acetabular metal cemented prosthesis shall have an approved PMA or a declared completed PDP in effect before being placed in commercial distribution.

[52 FR 33702, Sept. 4, 1987, as amended at 61 FR 50710, Sept. 27, 1996]

**§ 888.3380 Hip joint femoral (hemi-hip) trunnion-bearing metal/polyacetal cemented prosthesis.**

(a) *Identification.* A hip joint femoral (hemi-hip) trunnion-bearing metal/polyacetal cemented prosthesis is a two-part device intended to be implanted to replace the head and neck of the femur. This generic type of device includes prostheses that consist of a metallic stem made of alloys, such as cobalt-chromium-molybdenum, with an integrated cylindrical trunnion bearing at the upper end of the stem that fits into a recess in the head of the device. The head of the device is made of polyacetal (polyoxymethylene) and it is covered by a metallic alloy, such as cobalt-chromium-molybdenum. The trunnion bearing allows the head of the device to rotate on its stem. The prosthesis is intended for use with bone cement (§ 888.3027).

(b) *Classification.* Class III.

(c) *Date PMA or notice of completion of a PDP is required.* A PMA or a notice of completion of a PDP is required to be filed with the Food and Drug Administration on or before December 26, 1996 for any hip joint femoral (hemi-hip) trunnion-bearing metal/polyacetal cemented prosthesis that was in commercial distribution before May 28, 1976, or that has, on or before December 26, 1996 been found to be substantially equivalent to a hip joint femoral (hemi-hip) trunnion-bearing metal/polyacetal cemented prosthesis that was in commercial distribution before May 28, 1976. Any other hip joint femoral (hemi-hip) trunnion-bearing metal/polyacetal cemented prosthesis shall have an approved PMA or a declared completed PDP in effect before being placed in commercial distribution.

[52 FR 33702, Sept. 4, 1987, as amended at 61 FR 50710, Sept. 27, 1996]

**§ 888.3390 Hip joint femoral (hemi-hip) metal/polymer cemented or uncemented prosthesis.**

(a) *Identification.* A hip joint femoral (hemi-hip) metal/polymer cemented or uncemented prosthesis is a two-part device intended to be implanted to replace the head and neck of the femur. This generic type of device includes prostheses that have a femoral component made of alloys, such as cobalt-

chromium-molybdenum, and a snap-fit acetabular component made of an alloy, such as cobalt-chromium-molybdenum, and ultra-high molecular weight polyethylene. This generic type of device may be fixed to the bone with bone cement (§ 888.3027) or implanted by impaction.

(b) *Classification.* Class II.

**§ 888.3400 Hip joint femoral (hemi-hip) metallic resurfacing prosthesis.**

(a) *Identification.* A hip joint femoral (hemi-hip) metallic resurfacing prosthesis is a device intended to be implanted to replace a portion of the hip joint. This generic type of device includes prostheses that have a femoral resurfacing component made of alloys, such as cobalt-chromium-molybdenum.

(b) *Classification.* Class II.

**§ 888.3410 Hip joint metal/polymer or ceramic/polymer semiconstrained resurfacing cemented prosthesis.**

(a) *Identification.* A hip joint metal/polymer or ceramic/polymer semi-constrained resurfacing cemented prosthesis is a two-part device intended to be implanted to replace the articulating surfaces of the hip while preserving the femoral head and neck. The device limits translation and rotation in one or more planes via the geometry of its articulating surfaces. It has no linkage across the joint. This generic type of device includes prostheses that consist of a femoral cap component made of a metal alloy, such as cobalt-chromium-molybdenum, or a ceramic material, that is placed over a surgically prepared femoral head, and an acetabular resurfacing polymer component. Both components are intended for use with bone cement (§ 888.3027).

(b) *Classification.* Class III.

(c) *Date PMA or notice of completion of a PDP is required.* A PMA or a notice of completion of a PDP is required to be filed with the Food and Drug Administration on or before January 3, 2005, for any hip joint metal/polymer or ceramic/polymer semiconstrained resurfacing cemented prosthesis that was in commercial distribution before May 28, 1976, or that has, on or before January 3, 2005, been found to be substantially equivalent to a hip joint metal/polymer or ceramic/polymer semiconstrained



resurfacing cemented prosthesis that was in commercial distribution before May 28, 1976. Any other hip joint metal/polymer or ceramic/polymer semiconstrained resurfacing cemented prosthesis must have an approved PMA or a declared completed PDP in effect before being placed in commercial distribution.

[69 FR 59134, Oct. 4, 2004]

**§ 888.3480 Knee joint femorotibial metallic constrained cemented prosthesis.**

(a) *Identification.* A knee joint femorotibial metallic constrained cemented prosthesis is a device intended to be implanted to replace part of a knee joint. The device prevents dislocation in more than one anatomic plane and has components that are linked together. The only knee joint movement allowed by the device is in the sagittal plane. This generic type of device includes prostheses that have an intramedullary stem at both the proximal and distal locations. The upper and lower components may be joined either by a solid bolt or pin, an internally threaded bolt with locking screw, or a bolt retained by circlip. The components of the device are made of alloys, such as cobalt-chromium-molybdenum. The stems of the device may be perforated, but are intended for use with bone cement (§ 888.3027).

(b) *Classification.* Class III.

(c) *Date PMA or notice of completion of a PDP is required.* A PMA or a notice of completion of a PDP is required to be filed with the Food and Drug Administration on or before December 26, 1996 for any knee joint femorotibial metallic constrained cemented prosthesis that was in commercial distribution before May 28, 1976, or that has, on or before December 26, 1996 been found to be substantially equivalent to a knee joint femorotibial metallic constrained cemented prosthesis that was in commercial distribution before May 28, 1976. Any other knee joint femorotibial metallic constrained cemented prosthesis shall have an approved PMA or a declared completed PDP in effect before being placed in commercial distribution.

[52 FR 33702, Sept. 4, 1987, as amended at 61 FR 50710, Sept. 27, 1996]

**§ 888.3490 Knee joint femorotibial metal/composite non-constrained cemented prosthesis.**

(a) *Identification.* A knee joint femorotibial metal/composite non-constrained cemented prosthesis is a device intended to be implanted to replace part of a knee joint. The device limits minimally (less than normal anatomic constraints) translation in one or more planes. It has no linkage across-the-joint. This generic type of device includes prostheses that have a femoral condylar resurfacing component or components made of alloys, such as cobalt-chromium-molybdenum, and a tibial condylar component or components made of ultra-high molecular weight polyethylene with carbon fibers composite and are intended for use with bone cement (§ 888.3027).

(b) *Classification.* Class II.

**§ 888.3500 Knee joint femorotibial metal/composite semi-constrained cemented prosthesis.**

(a) *Identification.* A knee joint femorotibial metal/composite semi-constrained cemented prosthesis is a two-part device intended to be implanted to replace part of a knee joint. The device limits translation and rotation in one or more planes via the geometry of its articulating surfaces. It has no linkage across-the-joint. This generic type of device includes prostheses that have a femoral component made of alloys, such as cobalt-chromium-molybdenum, and a tibial component with the articulating surfaces made of ultra-high molecular weight polyethylene with carbon-fibers composite and is limited to those prostheses intended for use with bone cement (§ 888.3027).

(b) *Classification.* Class II.

**§ 888.3510 Knee joint femorotibial metal/polymer constrained cemented prosthesis.**

(a) *Identification.* A knee joint femorotibial metal/polymer constrained cemented prosthesis is a device intended to be implanted to replace part of a knee joint. The device limits translation or rotation in one or more planes and has components that are linked together or affixed. This generic type of device includes prostheses

§ 888.3520

composed of a ball-and-socket joint located between a stemmed femoral and a stemmed tibial component and a runner and track joint between each pair of femoral and tibial condyles. The ball-and-socket joint is composed of a ball at the head of a column rising from the stemmed tibial component. The ball, the column, the tibial plateau, and the stem for fixation of the tibial component are made of an alloy, such as cobalt-chromium-molybdenum. The ball of the tibial component is held within the socket of the femoral component by the femoral component's flat outer surface. The flat outer surface of the tibial component abuts both a reciprocal flat surface within the cavity of the femoral component and flanges on the femoral component designed to prevent distal displacement. The stem of the femoral component is made of an alloy, such as cobalt-chromium-molybdenum, but the socket of the component is made of ultra-high molecular weight polyethylene. The femoral component has metallic runners which align with the ultra-high molecular weight polyethylene tracks that press-fit into the metallic tibial component. The generic class also includes devices whose upper and lower components are linked with a solid bolt passing through a journal bearing of greater radius, permitting some rotation in the transverse plane, a minimal arc of abduction/adduction. This generic type of device is limited to those prostheses intended for use with bone cement (§888.3027).

(b) *Classification.* Class II.

**§ 888.3520 Knee joint femorotibial metal/polymer non-constrained cemented prosthesis.**

(a) *Identification.* A knee joint femorotibial metal/polymer non-constrained cemented prosthesis is a device intended to be implanted to replace part of a knee joint. The device limits minimally (less than normal anatomic constraints) translation in one or more planes. It has no linkage across-the-joint. This generic type of device includes prostheses that have a femoral condylar resurfacing component or components made of alloys, such as cobalt-chromium-molybdenum, and a tibial component or components

21 CFR Ch. I (4-1-20 Edition)

made of ultra-high molecular weight polyethylene and are intended for use with bone cement (§888.3027).

(b) *Classification.* Class II.

**§ 888.3530 Knee joint femorotibial metal/polymer semi-constrained cemented prosthesis.**

(a) *Identification.* A knee joint femorotibial metal/polymer semi-constrained cemented prosthesis is a device intended to be implanted to replace part of a knee joint. The device limits translation and rotation in one or more planes via the geometry of its articulating surfaces. It has no linkage across-the-joint. This generic type of device includes prostheses that consist of a femoral component made of alloys, such as cobalt-chromium-molybdenum, and a tibial component made of ultra-high molecular weight polyethylene and is limited to those prostheses intended for use with bone cement (§888.3027).

(b) *Classification.* Class II.

**§ 888.3535 Knee joint femorotibial (uni-compartmental) metal/polymer porous-coated uncemented prosthesis.**

(a) *Identification.* A knee joint femorotibial (uni-compartmental) metal/polymer porous-coated uncemented prosthesis is a device intended to be implanted to replace part of a knee joint. The device limits translation and rotation in one or more planes via the geometry of its articulating surface. It has no linkage across-the-joint. This generic type of device is designed to achieve biological fixation to bone without the use of bone cement. This identification includes fixed-bearing knee prostheses where the ultra-high molecular weight polyethylene tibial bearing is rigidly secured to the metal tibial baseplate.

(b) *Classification.* Class II (special controls). The special control is FDA's guidance: "Class II Special Controls Guidance Document: Knee Joint Patellofemorotibial and Femorotibial Metal/Polymer Porous-Coated Uncemented Prostheses; Guidance for Industry and FDA." See §888.1 for the availability of this guidance.

[68 FR 14137, Mar. 24, 2003]

**§ 888.3540 Knee joint patellofemoral polymer/metal semi-constrained cemented prosthesis.**

(a) *Identification.* A knee joint patellofemoral polymer/metal semi-constrained cemented prosthesis is a two-part device intended to be implanted to replace part of a knee joint in the treatment of primary patellofemoral arthritis or chondromalacia. The device limits translation and rotation in one or more planes via the geometry of its articulating surfaces. It has no linkage across-the-joint. This generic type of device includes a component made of alloys, such as cobalt-chromium-molybdenum or austenitic steel, for resurfacing the intercondylar groove (femoral sulcus) on the anterior aspect of the distal femur, and a patellar component made of ultra-high molecular weight polyethylene. This generic type of device is limited to those devices intended for use with bone cement (§ 888.3027). The patellar component is designed to be implanted only with its femoral component.

(b) *Classification.* Class II. The special controls for this device are:

(1) FDA's:

(i) "Use of International Standard ISO 10993 'Biological Evaluation of Medical Devices—Part I: Evaluation and Testing,'" "

(ii) "510(k) Sterility Review Guidance of 2/12/90 (K90-1)," "

(iii) "Guidance Document for Testing Orthopedic Implants with Modified Metallic Surfaces Apposing Bone or Bone Cement," "

(iv) "Guidance Document for the Preparation of Premarket Notification (510(k)) Applications for Orthopedic Devices," and

(v) "Guidance Document for Testing Non-articulating, 'Mechanically Locked' Modular Implant Components," and

(2) International Organization for Standardization's (ISO):

(i) ISO 5832-3:1996 "Implants for Surgery—Metallic Materials—Part 3: Wrought Titanium 6-Aluminum 4-Vandium Alloy," "

(ii) ISO 5832-4:1996 "Implants for Surgery—Metallic Materials—Part 4: Cobalt-Chromium-Molybdenum Casting Alloy," "

(iii) ISO 5832-12:1996 "Implants for Surgery—Metallic Materials—Part 12: Wrought Cobalt-Chromium-Molybdenum Alloy," "

(iv) ISO 5833:1992 "Implants for Surgery—Acrylic Resin Cements," "

(v) ISO 5834-2:1998 "Implants for Surgery—Ultra-high Molecular Weight Polyethylene—Part 2: Moulded Forms," "

(vi) ISO 6018:1987 "Orthopaedic Implants—General Requirements for Marking, Packaging, and Labeling," "

(vii) ISO 7207-2:1998 "Implants for Surgery—Components for Partial and Total Knee Joint Prostheses—Part 2: Articulating Surfaces Made of Metal, Ceramic and Plastic Materials," and

(viii) ISO 9001:1994 "Quality Systems—Model for Quality Assurance in Design/Development, Production, Installation, and Servicing," and

(3) American Society for Testing and Materials':

(i) F 75-92 "Specification for Cast Cobalt-28 Chromium-6 Molybdenum Alloy for Surgical Implant Material," "

(ii) F 648-98 "Specification for Ultra-High-Molecular-Weight Polyethylene Powder and Fabricated Form for Surgical Implants," "

(iii) F 799-96 "Specification for Cobalt-28 Chromium-6 Molybdenum Alloy Forgings for Surgical Implants," "

(iv) F 1044-95 "Test Method for Shear Testing of Porous Metal Coatings," "

(v) F 1108-97 "Titanium-6 Aluminum-4 Vanadium Alloy Castings for Surgical Implants," "

(vi) F 1147-95 "Test Method for Tension Testing of Porous Metal Coatings," "

(vii) F 1537-94 "Specification for Wrought Cobalt-28 Chromium-6 Molybdenum Alloy for Surgical Implants," and

(viii) F 1672-95 "Specification for Resurfacing Patellar Prosthesis." "

[52 FR 33702, Sept. 4, 1987, as amended at 61 FR 50710, Sept. 27, 1996; 65 FR 17147, Mar. 31, 2000]

**§ 888.3550 Knee joint patellofemorotibial polymer/metal/metal constrained cemented prosthesis.**

(a) *Identification.* A knee joint patellofemorotibial polymer/metal/metal constrained cemented prosthesis

§ 888.3560

21 CFR Ch. I (4-1-20 Edition)

is a device intended to be implanted to replace a knee joint. The device prevents dislocation in more than one anatomic plane and has components that are linked together. This generic type of device includes prostheses that have a femoral component, a tibial component, a cylindrical bolt and accompanying locking hardware that are all made of alloys, such as cobalt-chromium-molybdenum, and a retropatellar resurfacing component made of ultra-high molecular weight polyethylene. The retropatellar surfacing component may be attached to the resected patella either with a metallic screw or bone cement. All stemmed metallic components within this generic type are intended for use with bone cement (§ 888.3027).

(b) *Classification.* Class III.

(c) *Date PMA or notice of completion of a PDP is required.* A PMA or a notice of completion of a PDP is required to be filed with the Food and Drug Administration on or before December 26, 1996 for any knee joint patellofemorotibial polymer/metal/metal constrained cemented prosthesis that was in commercial distribution before May 28, 1976, or that has, on or before December 26, 1996 been found to be substantially equivalent to a knee joint patellofemorotibial polymer/metal/metal constrained cemented prosthesis that was in commercial distribution before May 28, 1976. Any other knee joint patellofemorotibial polymer/metal/metal constrained cemented prosthesis shall have an approved PMA or a declared completed PDP in effect before being placed in commercial distribution.

[52 FR 33702, Sept. 4, 1987, as amended at 61 FR 50710, Sept. 27, 1996]

§ 888.3560 **Knee joint patellofemorotibial polymer/metal/polymer semi-constrained cemented prosthesis.**

(a) *Identification.* A knee joint patellofemorotibial polymer/metal/polymer semi-constrained cemented prosthesis is a device intended to be implanted to replace a knee joint. The device limits translation and rotation in one or more planes via the geometry of its articulating surfaces. It has no linkage across-the-joint. This generic

type of device includes prostheses that have a femoral component made of alloys, such as cobalt-chromium-molybdenum, and a tibial component or components and a retropatellar resurfacing component made of ultra-high molecular weight polyethylene. This generic type of device is limited to those prostheses intended for use with bone cement (§ 888.3027).

(b) *Classification.* Class II.

§ 888.3565 **Knee joint patellofemorotibial metal/polymer porous-coated uncemented prosthesis.**

(a) *Identification.* A knee joint patellofemorotibial metal/polymer porous-coated uncemented prosthesis is a device intended to be implanted to replace a knee joint. The device limits translation and rotation in one or more planes via the geometry of its articulating surfaces. It has no linkage across-the-joint. This generic type of device is designed to achieve biological fixation to bone without the use of bone cement. This identification includes fixed-bearing knee prostheses where the ultra high molecular weight polyethylene tibial bearing is rigidly secured to the metal tibial base plate.

(b) *Classification.* Class II (special controls). The special control is FDA's guidance: "Class II Special Controls Guidance Document: Knee Joint Patellofemorotibial and Femorotibial Metal/Polymer Porous-Coated Uncemented Prostheses; Guidance for Industry and FDA." See § 888.1 for the availability of this guidance.

[68 FR 14137, Mar. 24, 2003]

§ 888.3570 **Knee joint femoral (hemi-knee) metallic uncemented prosthesis.**

(a) *Identification.* A knee joint femoral (hemi-knee) metallic uncemented prosthesis is a device made of alloys, such as cobalt-chromium-molybdenum, intended to be implanted to replace part of a knee joint. The device limits translation and rotation in one or more planes via the geometry of its articulating surfaces. It has no linkage across-the-joint. This generic type of device includes prostheses that consist

of a femoral component with or without protuberance(s) for the enhancement of fixation and is limited to those prostheses intended for use without bone cement (§ 888.3027).

(b) *Classification*. Class III.

(c) *Date PMA or notice of completion of a PDP is required*. A PMA or a notice of completion of a PDP is required to be filed with the Food and Drug Administration on or before December 26, 1996 for any knee joint femoral (hemi-knee) metallic uncemented prosthesis that was in commercial distribution before May 28, 1976, or that has, on or before December 26, 1996 been found to be substantially equivalent to a knee joint femoral (hemi-knee) metallic uncemented prosthesis that was in commercial distribution before May 28, 1976. Any other knee joint femoral (hemi-knee) metallic uncemented prosthesis shall have an approved PMA or a declared completed PDP in effect before being placed in commercial distribution.

[52 FR 33702, Sept. 4, 1987, as amended at 61 FR 50710, Sept. 27, 1996]

**§ 888.3580 Knee joint patellar (hemi-knee) metallic resurfacing uncemented prosthesis.**

(a) *Identification*. A knee joint patellar (hemi-knee) metallic resurfacing uncemented prosthesis is a device made of alloys, such as cobalt-chromium-molybdenum, intended to be implanted to replace the retropatellar articular surface of the patellofemoral joint. The device limits minimally (less than normal anatomic constraints) translation in one or more planes. It has no linkage across-the-joint. This generic type of device includes prostheses that have a retropatellar resurfacing component and an orthopedic screw to transfix the patellar remnant. This generic type of device is limited to those prostheses intended for use without bone cement (§ 888.3027).

(b) *Classification*. (1) Class II when intended for treatment of degenerative and posttraumatic patellar arthritis.

(2) Class III when intended for uses other than treatment of degenerative and posttraumatic patellar arthritis.

(c) *Date PMA or notice of completion of a PDP is required*. A PMA or a notice of completion of a PDP is required to be

filed with the Food and Drug Administration on or before December 26, 1996 for any knee joint patellar (hemi-knee) metallic resurfacing uncemented prosthesis described in paragraph (b)(2) of this section that was in commercial distribution before May 28, 1976, or that has, on or before December 26, 1996 been found to be substantially equivalent to a knee joint patellar (hemi-knee) metallic resurfacing uncemented prosthesis that was in commercial distribution before May 28, 1976. Any other knee joint patellar (hemi-knee) metallic resurfacing uncemented prosthesis shall have an approved PMA or a declared completed PDP in effect before being placed in commercial distribution.

[52 FR 33702, Sept. 4, 1987, as amended at 61 FR 50711, Sept. 27, 1996]

**§ 888.3590 Knee joint tibial (hemi-knee) metallic resurfacing uncemented prosthesis.**

(a) *Identification*. A knee joint tibial (hemi-knee) metallic resurfacing uncemented prosthesis is a device intended to be implanted to replace part of a knee joint. The device limits minimally (less than normal anatomic constraints) translation in one or more planes. It has no linkage across-the-joint. This prosthesis is made of alloys, such as cobalt-chromium-molybdenum, and is intended to resurface one tibial condyle. The generic type of device is limited to those prostheses intended for use without bone cement (§ 888.3027).

(b) *Classification*. Class II.

**§ 888.3640 Shoulder joint metal/metal or metal/polymer constrained cemented prosthesis.**

(a) *Identification*. A shoulder joint metal/metal or metal/polymer constrained cemented prosthesis is a device intended to be implanted to replace a shoulder joint. The device prevents dislocation in more than one anatomic plane and has components that are linked together. This generic type of device includes prostheses that have a humeral component made of alloys, such as cobalt-chromium-molybdenum, and a glenoid component made of this alloy or a combination of this alloy and ultra-high molecular weight

polyethylene. This generic type of device is limited to those prostheses intended for use with bone cement (§ 888.3027).

(b) *Classification*. Class III.

(c) *Date PMA or notice of completion of a PDP is required*. A PMA or a notice of completion of a PDP is required to be filed with the Food and Drug Administration on or before December 26, 1996 for any shoulder joint metal/metal or metal/polymer constrained cemented prosthesis that was in commercial distribution before May 28, 1976, or that has, on or before December 26, 1996 been found to be substantially equivalent to a shoulder joint metal/metal or metal/polymer constrained cemented prosthesis that was in commercial distribution before May 28, 1976. Any other shoulder joint metal/metal or metal/polymer constrained cemented prosthesis shall have an approved PMA or a declared completed PDP in effect before being placed in commercial distribution.

[52 FR 33702, Sept. 4, 1987, as amended at 61 FR 50711, Sept. 27, 1996]

**§ 888.3650 Shoulder joint metal/polymer non-constrained cemented prosthesis.**

(a) *Identification*. A shoulder joint metal/polymer non-constrained cemented prosthesis is a device intended to be implanted to replace a shoulder joint. The device limits minimally (less than normal anatomic constraints) translation in one or more planes. It has no linkage across-the-joint. This generic type of device includes prostheses that have a humeral component made of alloys, such as cobalt-chromium-molybdenum, and a glenoid resurfacing component made of ultra-high molecular weight polyethylene, and is limited to those prostheses intended for use with bone cement (§ 888.3027).

(b) *Classification*. Class II. The special controls for this device are:

(1) FDA's:

(i) "Use of International Standard ISO 10993 'Biological Evaluation of Medical Devices—Part I: Evaluation and Testing,'" "

(ii) "510(k) Sterility Review Guidance of 2/12/90 (K90-1)," "

(iii) "Guidance Document for Testing Orthopedic Implants with Modified Metallic Surfaces Apposing Bone or Bone Cement," "

(iv) "Guidance Document for the Preparation of Premarket Notification (510(k)) Application for Orthopedic Devices," and

(v) "Guidance Document for Testing Non-articulating, 'Mechanically Locked' Modular Implant Components," "

(2) International Organization for Standardization's (ISO):

(i) ISO 5832-3:1996 "Implants for Surgery—Metallic Materials—Part 3: Wrought Titanium 6-Aluminum 4-Vandium Alloy," "

(ii) ISO 5832-4:1996 "Implants for Surgery—Metallic Materials—Part 4: Cobalt-Chromium-Molybdenum Casting Alloy," "

(iii) ISO 5832-12:1996 "Implants for Surgery—Metallic Materials—Part 12: Wrought Cobalt-Chromium-Molybdenum Alloy," "

(iv) ISO 5833:1992 "Implants for Surgery—Acrylic Resin Cements," "

(v) ISO 5834-2:1998 "Implants for Surgery—Ultra-high Molecular Weight Polyethylene—Part 2: Moulded Forms," "

(vi) ISO 6018:1987 "Orthopaedic Implants—General Requirements for Marking, Packaging, and Labeling," and

(vii) ISO 9001:1994 "Quality Systems—Model for Quality Assurance in Design/Development, Production, Installation, and Servicing," and

(3) American Society for Testing and Materials':

(i) F 75-92 "Specification for Cast Cobalt-28 Chromium-6 Molybdenum Alloy for Surgical Implant Material," "

(ii) F 648-98 "Specification for Ultra-High-Molecular-Weight Polyethylene Powder and Fabricated Form for Surgical Implants," "

(iii) F 799-96 "Specification for Cobalt-28 Chromium-6 Molybdenum Alloy Forgings for Surgical Implants," "

(iv) F 1044-95 "Test Method for Shear Testing of Porous Metal Coatings," "

(v) F 1108-97 "Titanium-6 Aluminum-4 Vanadium Alloy Castings for Surgical Implants," "

(vi) F 1147-95 "Test Method for Tension Testing of Porous Metal Coatings,"

(vii) F 1378-97 "Specification for Shoulder Prosthesis," and

(viii) F 1537-94 "Specification for Wrought Cobalt-28 Chromium-6 Molybdenum Alloy for Surgical Implants."

[52 FR 33702, Sept. 4, 1987, as amended at 65 FR 17148, Mar. 31, 2000]

**§ 888.3660 Shoulder joint metal/polymer semi-constrained cemented prosthesis.**

(a) *Identification.* A shoulder joint metal/polymer semi-constrained cemented prosthesis is a device intended to be implanted to replace a shoulder joint. The device limits translation and rotation in one or more planes via the geometry of its articulating surfaces. It has no linkage across-the-joint. This generic type of device includes prostheses that have a humeral resurfacing component made of alloys, such as cobalt-chromium-molybdenum, and a glenoid resurfacing component made of ultra-high molecular weight polyethylene, and is limited to those prostheses intended for use with bone cement (§ 888.3027).

(b) *Classification.* Class II. The special controls for this device are:

(1) FDA's:

(i) "Use of International Standard ISO 10993 'Biological Evaluation of Medical Devices—Part I: Evaluation and Testing,'" "

(ii) "510(k) Sterility Review Guidance of 2/12/90 (K90-1)," "

(iii) "Guidance Document for Testing Orthopedic Implants with Modified Metallic Surfaces Apposing Bone or Bone Cement," "

(iv) "Guidance Document for the Preparation of Premarket Notification (510(k)) Application for Orthopedic Devices," and

(v) "Guidance Document for Testing Non-articulating, 'Mechanically Locked' Modular Implant Components," "

(2) International Organization for Standardization's (ISO):

(i) ISO 5832-3:1996 "Implants for Surgery—Metallic Materials—Part 3: Wrought Titanium 6-aluminum 4-vandium Alloy," "

(ii) ISO 5832-4:1996 "Implants for Surgery—Metallic Materials—Part 4: Cobalt-chromium-molybdenum casting alloy," "

(iii) ISO 5832-12:1996 "Implants for Surgery—Metallic Materials—Part 12: Wrought Cobalt-chromium-molybdenum alloy," "

(iv) ISO 5833:1992 "Implants for Surgery—Acrylic Resin Cements," "

(v) ISO 5834-2:1998 "Implants for Surgery—Ultra-high Molecular Weight Polyethylene—Part 2: Moulded Forms," "

(vi) ISO 6018:1987 "Orthopaedic Implants—General Requirements for Marking, Packaging, and Labeling," and

(vii) ISO 9001:1994 "Quality Systems—Model for Quality Assurance in Design/Development, Production, Installation, and Servicing," and

(3) American Society for Testing and Materials':

(i) F 75-92 "Specification for Cast Cobalt-28 Chromium-6 Molybdenum Alloy for Surgical Implant Material," "

(ii) F 648-98 "Specification for Ultra-High-Molecular-Weight Polyethylene Powder and Fabricated Form for Surgical Implants," "

(iii) F 799-96 "Specification for Cobalt-28 Chromium-6 Molybdenum Alloy Forgings for Surgical Implants," "

(iv) F 1044-95 "Test Method for Shear Testing of Porous Metal Coatings," "

(v) F 1108-97 "Specification for Titanium-6 Aluminum-4 Vanadium Alloy Castings for Surgical Implants," "

(vi) F 1147-95 "Test Method for Tension Testing of Porous Metal," "

(vii) F 1378-97 "Standard Specification for Shoulder Prosthesis," and

(viii) F 1537-94 "Specification for Wrought Cobalt-28 Chromium-6 Molybdenum Alloy for Surgical Implants."

[52 FR 33702, Sept. 4, 1987, as amended at 65 FR 17148, Mar. 31, 2000]

**§ 888.3670 Shoulder joint metal/polymer/metal nonconstrained or semi-constrained porous-coated uncemented prosthesis.**

(a) *Identification.* A shoulder joint metal/polymer/metal nonconstrained or semi-constrained porous-coated uncemented prosthesis is a device intended to be implanted to replace a

**§ 888.3680**

shoulder joint. The device limits movement in one or more planes. It has no linkage across-the-joint. This generic type of device includes prostheses that have a humeral component made of alloys such as cobalt-chromium-molybdenum (Co-Cr-Mo) and titanium-aluminum-vanadium (Ti-6Al-4V) alloys, and a glenoid resurfacing component made of ultra-high molecular weight polyethylene, or a combination of an articulating ultra-high molecular weight bearing surface fixed in a metal shell made of alloys such as Co-Cr-Mo and Ti-6Al-4V. The humeral component and glenoid backing have a porous coating made of, in the case of Co-Cr-Mo components, beads of the same alloy or commercially pure titanium powder, and in the case of Ti-6Al-4V components, beads or fibers of commercially pure titanium or Ti-6Al-4V alloy, or commercially pure titanium powder. The porous coating has a volume porosity between 30 and 70 percent, an average pore size between 100 and 1,000 microns, interconnecting porosity, and a porous coating thickness between 500 and 1,500 microns. This generic type of device is designed to achieve biological fixation to bone without the use of bone cement.

(b) *Classification.* Class II (special controls). The special control for this device is FDA's "Class II Special Controls Guidance: Shoulder Joint Metal/Polymer/Metal Nonconstrained or Semi-Constrained Porous-Coated Uncemented Prosthesis."

[66 FR 12737, Feb. 28, 2001]

**§ 888.3680 Shoulder joint glenoid (hemi-shoulder) metallic cemented prosthesis.**

(a) *Identification.* A shoulder joint glenoid (hemi-shoulder) metallic cemented prosthesis is a device that has a glenoid (socket) component made of alloys, such as cobalt-chromium-molybdenum, or alloys with ultra-high molecular weight polyethylene and intended to be implanted to replace part of a shoulder joint. This generic type of device is limited to those prostheses intended for use with bone cement (§ 888.3027).

(b) *Classification.* Class III.

(c) *Date PMA or notice of completion of a PDP is required.* A PMA or a notice of

**21 CFR Ch. I (4-1-20 Edition)**

completion of a PDP is required to be filed with the Food and Drug Administration on or before December 26, 1996 for any shoulder joint glenoid (hemi-shoulder) metallic cemented prosthesis that was in commercial distribution before May 28, 1976, or that has, on or before December 26, 1996 been found to be substantially equivalent to a shoulder joint glenoid (hemi-shoulder) metallic cemented prosthesis that was in commercial distribution before May 28, 1976. Any other shoulder joint glenoid (hemi-shoulder) metallic cemented prosthesis shall have an approved PMA or a declared completed PDP in effect before being placed in commercial distribution.

[52 FR 33702, Sept. 4, 1987, as amended at 61 FR 50711, Sept. 27, 1996]

**§ 888.3690 Shoulder joint humeral (hemi-shoulder) metallic uncemented prosthesis.**

(a) *Identification.* A shoulder joint humeral (hemi-shoulder) metallic uncemented prosthesis is a device made of alloys, such as cobalt-chromium-molybdenum. It has an intramedullary stem and is intended to be implanted to replace the articular surface of the proximal end of the humerus and to be fixed without bone cement (§ 888.3027). This device is not intended for biological fixation.

(b) *Classification.* Class II.

**§ 888.3720 Toe joint polymer constrained prosthesis.**

(a) *Identification.* A toe joint polymer constrained prosthesis is a device made of silicone elastomer or polyester reinforced silicone elastomer intended to be implanted to replace the first metatarsophalangeal (big toe) joint. This generic type of device consists of a single flexible across-the-joint component that prevents dislocation in more than one anatomic plane.

(b) *Classification.* Class II.

**§ 888.3730 Toe joint phalangeal (hemi-toe) polymer prosthesis.**

(a) *Identification.* A toe joint phalangeal (hemi-toe) polymer prosthesis is a device made of silicone elastomer intended to be implanted to replace the base of the proximal phalanx of the toe.



(b) *Classification*. Class II.

**§ 888.3750 Wrist joint carpal lunate polymer prosthesis.**

(a) *Identification*. A wrist joint carpal lunate prosthesis is a one-piece device made of silicone elastomer intended to be implanted to replace the carpal lunate bone of the wrist.

(b) *Classification*. Class II.

**§ 888.3760 Wrist joint carpal scaphoid polymer prosthesis.**

(a) *Identification*. A wrist joint carpal scaphoid polymer prosthesis is a one-piece device made of silicone elastomer intended to be implanted to replace the carpal scaphoid bone of the wrist.

(b) *Classification*. Class II.

**§ 888.3770 Wrist joint carpal trapezium polymer prosthesis.**

(a) *Identification*. A wrist joint carpal trapezium polymer prosthesis is a one-piece device made of silicone elastomer or silicone elastomer/polyester material intended to be implanted to replace the carpal trapezium bone of the wrist.

(b) *Classification*. Class II.

**§ 888.3780 Wrist joint polymer constrained prosthesis.**

(a) *Identification*. A wrist joint polymer constrained prosthesis is a device made of polyester-reinforced silicone elastomer intended to be implanted to replace a wrist joint. This generic type of device consists of a single flexible across-the-joint component that prevents dislocation in more than one anatomic plane.

(b) *Classification*. Class II.

**§ 888.3790 Wrist joint metal constrained cemented prosthesis.**

(a) *Identification*. A wrist joint metal constrained cemented prosthesis is a device intended to be implanted to replace a wrist joint. The device prevents dislocation in more than one anatomic plane and consists of either a single flexible across-the-joint component or two components linked together. This generic type of device is limited to a device which is made of alloys, such as cobalt-chromium-molybdenum, and is limited to those prostheses intended for use with bone cement (§ 888.3027).

(b) *Classification*. Class III.

(c) *Date PMA or notice of completion of a PDP is required*. A PMA or a notice of completion of a PDP is required to be filed with the Food and Drug Administration on or before December 26, 1996 for any wrist joint metal constrained cemented prosthesis that was in commercial distribution before May 28, 1976, or that has, on or before December 26, 1996 been found to be substantially equivalent to a wrist joint metal constrained cemented prosthesis that was in commercial distribution before May 28, 1976. Any other wrist joint metal constrained cemented prosthesis shall have an approved PMA or a declared completed PDP in effect before being placed in commercial distribution.

[52 FR 33702, Sept. 4, 1987, as amended at 61 FR 50711, Sept. 27, 1996]

**§ 888.3800 Wrist joint metal/polymer semi-constrained cemented prosthesis.**

(a) *Identification*. A wrist joint metal/polymer semi-constrained cemented prosthesis is a device intended to be implanted to replace a wrist joint. The device limits translation and rotation in one or more planes via the geometry of its articulating surfaces. It has no linkage across-the-joint. This generic type of device includes prostheses that have either a one-part radial component made of alloys, such as cobalt-chromium-molybdenum, with an ultra-high molecular weight polyethylene bearing surface, or a two-part radial component made of alloys and an ultra-high molecular weight polyethylene ball that is mounted on the radial component with a trunnion bearing. The metallic portion of the two-part radial component is inserted into the radius. These devices have a meta-carpal component(s) made of alloys, such as cobalt-chromium-molybdenum. This generic type of device is limited to those prostheses intended for use with bone cement (§ 888.3027).

(b) *Classification*. Class II.

**§ 888.3810 Wrist joint ulnar (hemi-wrist) polymer prosthesis.**

(a) *Identification*. A wrist joint ulnar (hemi-wrist) polymer prosthesis is a mushroom-shaped device made of a

## § 888.4150

medical grade silicone elastomer or ultra-high molecular weight polyethylene intended to be implanted into the intramedullary canal of the bone and held in place by a suture. Its purpose is to cover the resected end of the distal ulna to control bone overgrowth and to provide an articular surface for the radius and carpus.

(b) *Classification.* Class II.

### Subpart E—Surgical Devices

#### § 888.4150 Calipers for clinical use.

(a) *Identification.* A caliper for clinical use is a compass-like device intended for use in measuring the thickness or diameter of a part of the body or the distance between two body surfaces, such as for measuring an excised skeletal specimen to determine the proper replacement size of a prosthesis.

(b) *Classification.* Class I (general controls). The device is exempt from the premarket notification procedures in subpart E of part 807 of this chapter, subject to the limitations in § 888.9.

[52 FR 33702, Sept. 4, 1987, as amended at 66 FR 38815, July 25, 2001]

#### § 888.4200 Cement dispenser.

(a) *Identification.* A cement dispenser is a nonpowered syringe-like device intended for use in placing bone cement (§ 888.3027) into surgical sites.

(b) *Classification.* Class I (general controls). The device is exempt from the premarket notification procedures in subpart E of part 807 of this chapter, subject to the limitations in § 888.9.

[52 FR 33702, Sept. 4, 1987, as amended at 53 FR 52953, Dec. 29, 1988; 59 FR 63014, Dec. 7, 1994; 66 FR 38815, July 25, 2001]

#### § 888.4210 Cement mixer for clinical use.

(a) *Identification.* A cement mixer for clinical use is a device consisting of a container intended for use in mixing bone cement (§ 888.3027).

(b) *Classification.* Class I (general controls). The device is exempt from the premarket notification procedures in subpart E of part 807 of this chapter, subject to the limitations in § 888.9.

[52 FR 33702, Sept. 4, 1987, as amended at 53 FR 52953, Dec. 29, 1988; 59 FR 63014, Dec. 7, 1994; 66 FR 38815, July 25, 2001]

## 21 CFR Ch. I (4–1–20 Edition)

#### § 888.4220 Cement monomer vapor evacuator.

(a) *Identification.* A cement monomer vapor evacuator is a device intended for use during surgery to contain or remove undesirable fumes, such as monomer vapor from bone cement (§ 888.3027).

(b) *Classification.* Class I (general controls). The device is exempt from the premarket notification procedures in subpart E of part 807 of this chapter, subject to the limitations in § 888.9.

[52 FR 33702, Sept. 4, 1987, as amended at 53 FR 52954, Dec. 29, 1988; 66 FR 38815, July 25, 2001]

#### § 888.4230 Cement ventilation tube.

(a) *Identification.* A cement ventilation tube is a tube-like device usually made of plastic intended to be inserted into a surgical cavity to allow the release of air or fluid from the cavity as it is being filled with bone cement (§ 888.3027).

(b) *Classification.* Class I (general controls). The device is exempt from the premarket notification procedures in subpart E of part 807 of this chapter, subject to the limitations in § 888.9.

[52 FR 33702, Sept. 4, 1987, as amended at 53 FR 52954, Dec. 29, 1988; 59 FR 63014, Dec. 7, 1994; 66 FR 38815, July 25, 2001]

#### § 888.4300 Depth gauge for clinical use.

(a) *Identification.* A depth gauge for clinical use is a measuring device intended for various medical purposes, such as to determine the proper length of screws for fastening the ends of a fractured bone.

(b) *Classification.* Class I (general controls). The device is exempt from the premarket notification procedures in subpart E of part 807 of this chapter, subject to the limitations in § 888.9.

[52 FR 33702, Sept. 4, 1987, as amended at 66 FR 38815, July 25, 2001]

#### § 888.4505 Orthopedic surgical instrumentation designed for osteochondral implants with press-fit fixation.

(a) *Identification.* Orthopedic surgical instruments designed for osteochondral implants with press-fit fixation are hand-held devices intended to manipulate bone and cartilage tissue or the

implant for the positioning, alignment, defect creation, and placement of press-fit osteochondral implants that utilize no additional means of fixation (*e.g.*, suture fixation, adhesives). This type of device includes instruments specific to the geometry of the implant.

(b) *Classification.* Class II (special controls). The special controls for this device are:

(1) Technical specifications regarding geometry of the instruments must be specified and validated to demonstrate that the instruments can safely position and place the implant.

(2) The patient contacting components of the device must be demonstrated to be biocompatible.

(3) Labeling must include:

(i) Identification of implant(s) and instruments which have been validated for use together; and

(ii) Validated methods and instructions for reprocessing any reusable parts.

[84 FR 57321, Oct. 25, 2019]

**§ 888.4540 Orthopedic manual surgical instrument.**

(a) *Identification.* An orthopedic manual surgical instrument is a nonpowered hand-held device intended for medical purposes to manipulate tissue, or for use with other devices in orthopedic surgery. This generic type of device includes the cerclage applier, awl, bender, drill brace, broach, burr, cork-screw, countersink, pin crimper, wire cutter, prosthesis driver, extractor, file, fork, needle holder, impactor, bending or contouring instrument, compression instrument, passer, socket positioner, probe, femoral neck punch, socket pusher, reamer, rongeur, scissors, screwdriver, bone skid, staple driver, bone screw starter, surgical stripper, tamp, bone tap, trephine, wire twister, and wrench.

(b) *Classification.* Class I (general controls). The device is exempt from the premarket notification procedures in subpart E of part 807 of this chapter, subject to the limitations in § 888.9.

[52 FR 33702, Sept. 4, 1987, as amended at 59 FR 63014, Dec. 7, 1994; 66 FR 38815, July 25, 2001]

**§ 888.4580 Sonic surgical instrument and accessories/attachments.**

(a) *Identification.* A sonic surgical instrument is a hand-held device with various accessories or attachments, such as a cutting tip that vibrates at high frequencies, and is intended for medical purposes to cut bone or other materials, such as acrylic.

(b) *Classification.* Class II (special controls). The device is exempt from the premarket notification procedures in subpart E of part 807 of this chapter subject to the limitations in § 888.9.

[52 FR 33702, Sept. 4, 1987, as amended at 84 FR 71818, Dec. 30, 2019]

**§ 888.4600 Protractor for clinical use.**

(a) *Identification.* A protractor for clinical use is a device intended for use in measuring the angles of bones, such as on x-rays or in surgery.

(b) *Classification.* Class I (general controls). The device is exempt from the premarket notification procedures in subpart E of part 807 of this chapter, subject to the limitations in § 888.9.

[52 FR 33702, Sept. 4, 1987, as amended at 66 FR 38815, July 25, 2001]

**§ 888.4800 Template for clinical use.**

(a) *Identification.* A template for clinical use is a device that consists of a pattern or guide intended for medical purposes, such as selecting or positioning orthopedic implants or guiding the marking of tissue before cutting.

(b) *Classification.* Class I (general controls). The device is exempt from the premarket notification procedures in subpart E of part 807 of this chapter, subject to the limitations in § 888.9.

[52 FR 33702, Sept. 4, 1987, as amended at 66 FR 38815, July 25, 2001]

**§ 888.5850 Nonpowered orthopedic traction apparatus and accessories.**

(a) *Identification.* A nonpowered orthopedic traction apparatus is a device that consists of a rigid frame with nonpowered traction accessories, such as cords, pulleys, or weights, and that is intended to apply a therapeutic pulling force to the skeletal system.

(b) *Classification.* Class I (general controls). The device is exempt from the premarket notification procedures in subpart E of part 807 of this chapter,

## § 888.5890

subject to the limitations in § 888.9. The device is also exempt from the current good manufacturing practice requirements of the quality system regulation in part 820 of this chapter, with the exception of § 820.180, regarding general requirements concerning records, and § 820.198, regarding complaint files.

[52 FR 33702, Sept. 4, 1987, as amended at 66 FR 38815, July 25, 2001]

### § 888.5890 Noninvasive traction component.

(a) *Identification.* A noninvasive traction component is a device, such as a head halter, pelvic belt, or a traction splint, that does not penetrate the skin and is intended to assist in connecting a patient to a traction apparatus so that a therapeutic pulling force may be applied to the patient's body.

(b) *Classification.* Class I (general controls). The device is exempt from the premarket notification procedures in subpart E of part 807 of this chapter, subject to the limitations in § 888.9. The device is also exempt from the current good manufacturing practice requirements of the quality system regulation in part 820 of this chapter, with the exception of § 820.180, regarding general requirements concerning records, and § 820.198, regarding complaint files.

[52 FR 33702, Sept. 4, 1987, as amended at 53 FR 52954, Dec. 29, 1988; 66 FR 38815, July 25, 2001]

### § 888.5940 Cast component.

(a) *Identification.* A cast component is a device intended for medical purposes to protect or support a cast. This generic type of device includes the cast heel, toe cap, cast support, and walking iron.

(b) *Classification.* Class I (general controls). The device is exempt from the premarket notification procedures in subpart E of part 807 of this chapter, subject to the limitations in § 888.9. The device is also exempt from the current good manufacturing practice requirements of the quality system regulation in part 820 of this chapter, with the exception of § 820.180, regarding general

## 21 CFR Ch. I (4–1–20 Edition)

requirements concerning records, and § 820.198, regarding complaint files.

[52 FR 33702, Sept. 4, 1987, as amended at 53 FR 52954, Dec. 29, 1988; 59 FR 63014, Dec. 7, 1994; 66 FR 38815, July 25, 2001]

### § 888.5960 Cast removal instrument.

(a) *Identification.* A cast removal instrument is an AC-powered, hand-held device intended to remove a cast from a patient. This generic type of device includes the electric cast cutter and cast vacuum.

(b) *Classification.* Class I (general controls). The device is exempt from the premarket notification procedures in subpart E of part 807 of this chapter, subject to the limitations in § 888.9.

[55 FR 48443, Nov. 20, 1990, as amended at 61 FR 1125, Jan. 16, 1996; 66 FR 38816, July 25, 2001]

### § 888.5980 Manual cast application and removal instrument.

(a) *Identification.* A manual cast application and removal instrument is a nonpowered hand-held device intended to be used in applying or removing a cast. This generic type of device includes the cast knife, cast spreader, plaster saw, plaster dispenser, and casting stand.

(b) *Classification.* Class I (general controls). The device is exempt from the premarket notification procedures in subpart E of part 807 of this chapter, subject to the limitations in § 888.9. The device is also exempt from the current good manufacturing practice requirements of the quality system regulation in part 820 of this chapter, with the exception of § 820.180, regarding general requirements concerning records, and § 820.198, regarding complaint files.

[52 FR 33702, Sept. 4, 1987, as amended at 53 FR 52954, Dec. 29, 1988; 66 FR 38816, July 25, 2001]

## PART 890—PHYSICAL MEDICINE DEVICES

### Subpart A—General Provisions

Sec.

890.1 Scope.

890.3 Effective dates of requirement for premarket approval.

890.9 Limitations of exemptions from section 510(k) of the Federal Food, Drug, and Cosmetic Act (the act).

#### Subpart B—Physical Medicine Diagnostic Devices

890.1175 Electrode cable.  
 890.1225 Chronaximeter.  
 890.1375 Diagnostic electromyograph.  
 890.1385 Diagnostic electromyograph needle electrode.  
 890.1450 Powered reflex hammer.  
 890.1575 Force-measuring platform.  
 890.1600 Intermittent pressure measurement system.  
 890.1615 Miniature pressure transducer.  
 890.1850 Diagnostic muscle stimulator.  
 890.1925 Isokinetic testing and evaluation system.

#### Subpart C [Reserved]

#### Subpart D—Physical Medicine Prosthetic Devices

890.3025 Prosthetic and orthotic accessory.  
 890.3075 Cane.  
 890.3100 Mechanical chair.  
 890.3110 Electric positioning chair.  
 890.3150 Crutch.  
 890.3175 Flotation cushion.  
 890.3410 External limb orthotic component.  
 890.3420 External limb prosthetic component.  
 890.3450 Upper extremity prosthesis including a simultaneously powered elbow and/or shoulder with greater than two simultaneous powered degrees of freedom and controlled by non-implanted electrical components.  
 890.3475 Limb orthosis.  
 890.3480 Powered lower extremity exoskeleton.  
 890.3490 Truncal orthosis.  
 890.3500 External assembled lower limb prosthesis.  
 890.3520 Plinth.  
 890.3610 Rigid pneumatic structure orthosis.  
 890.3640 Arm sling.  
 890.3665 Congenital hip dislocation abduction splint.  
 890.3675 Denis Brown splint.  
 890.3690 Powered wheeled stretcher.  
 890.3700 Nonpowered communication system.  
 890.3710 Powered communication system.  
 890.3725 Powered environmental control system.  
 890.3750 Mechanical table.  
 890.3760 Powered table.  
 890.3790 Cane, crutch, and walker tips and pads.  
 890.3800 Motorized three-wheeled vehicle.  
 890.3825 Mechanical walker.  
 890.3850 Mechanical wheelchair.  
 890.3860 Powered wheelchair.

890.3880 Special grade wheelchair.  
 890.3890 Stair-climbing wheelchair.  
 890.3900 Standup wheelchair.  
 890.3910 Wheelchair accessory.  
 890.3920 Wheelchair component.  
 890.3930 Wheelchair elevator.  
 890.3940 Wheelchair platform scale.

#### Subpart E [Reserved]

#### Subpart F—Physical Medicine Therapeutic Devices

890.5050 Daily activity assist device.  
 890.5100 Immersion hydrobath.  
 890.5110 Paraffin bath.  
 890.5125 Nonpowered sitz bath.  
 890.5150 Powered patient transport.  
 890.5160 Air-fluidized bed.  
 890.5170 Powered flotation therapy bed.  
 890.5180 Manual patient rotation bed.  
 890.5225 Powered patient rotation bed.  
 890.5250 Moist steam cabinet.  
 890.5275 Microwave diathermy.  
 890.5290 Shortwave diathermy.  
 890.5300 Ultrasonic diathermy.  
 890.5350 Exercise component.  
 890.5360 Measuring exercise equipment.  
 890.5370 Nonmeasuring exercise equipment.  
 890.5380 Powered exercise equipment.  
 890.5410 Powered finger exerciser.  
 890.5500 Infrared lamp.  
 890.5525 Iontophoresis device.  
 890.5575 Powered external limb overload warning device.  
 890.5650 Powered inflatable tube massager.  
 890.5660 Therapeutic massager.  
 890.5670 Internal therapeutic massager.  
 890.5700 Cold pack.  
 890.5710 Hot or cold disposable pack.  
 890.5720 Water circulating hot or cold pack.  
 890.5730 Moist heat pack.  
 890.5740 Powered heating pad.  
 890.5760 Nonpowered lower extremity pressure wrap.  
 890.5765 Pressure-applying device.  
 890.5850 Powered muscle stimulator.  
 890.5860 Ultrasound and muscle stimulator.  
 890.5880 Multi-function physical therapy table.  
 890.5900 Powered traction equipment.  
 890.5925 Traction accessory.  
 890.5940 Chilling unit.  
 890.5950 Powered heating unit.  
 890.5975 Therapeutic vibrator.

AUTHORITY: 21 U.S.C. 351, 360, 360c, 360e, 360j, 360l, 371.

SOURCE: 48 FR 53047, Nov. 23, 1983, unless otherwise noted.

EDITORIAL NOTE: Nomenclature changes to part 890 appear at 73 FR 35341, June 23, 2008.

### Subpart A—General Provisions

#### § 890.1 Scope.

(a) This part sets forth the classification of physical medicine devices intended for human use that are in commercial distribution.

(b) The identification of a device in a regulation in this part is not a precise description of every device that is, or will be, subject to the regulation. A manufacturer who submits a premarket notification submission for a device under part 807 may not show merely that the device is accurately described by the section title and identification provisions of a regulation in this part, but shall state why the device is substantially equivalent to other devices, as required by § 807.87.

(c) To avoid duplicative listings, a physical medicine device that has two or more types of uses (e.g., used both as a diagnostic device and as a therapeutic device) is listed only in one subpart.

(d) References in this part to regulatory sections of the Code of Federal Regulations are to chapter I of title 21, unless otherwise noted.

(e) Guidance documents referenced in this part are available on the Internet at <http://www.fda.gov/MedicalDevices/DeviceRegulationandGuidance/GuidanceDocuments/default.htm>.

[52 FR 17741, May 11, 1987, as amended at 73 FR 34860, June 19, 2008; 78 FR 18233, Mar. 26, 2013]

#### § 890.3 Effective dates of requirement for premarket approval.

A device included in this part that is classified into class III (premarket approval) shall not be commercially distributed after the date shown in the regulation classifying the device unless the manufacturer has an approval under section 515 of the act (unless an exemption has been granted under section 520(g)(2) of the act). An approval under section 515 of the act consists of FDA's issuance of an order approving an application of premarket approval (PMA) for the device or declaring completed a product development protocol (PDP) for the device.

(a) Before FDA requires that a device commercially distributed before the enactment date of the amendments, or

a device that has been found substantially equivalent to such a device, has an approval under section 515 of the act FDA must promulgate a regulation under section 515(b) of the act requiring such approval, except as provided in paragraph (b) of this section. Such a regulation under section 515(b) of the act shall not be effective during the grace period ending on the 90th day after its promulgation or on the last day of the 30th full calendar month after the regulation that classifies the device into class III is effective, whichever is later. See section 501(f)(2)(B) of the act. Accordingly, unless an effective date of the requirement for premarket approval is shown in the regulation for a device classified into class III in this part, the device may be commercially distributed without FDA's issuance of an order approving a PMA or declaring completed a PDP for the device. If FDA promulgates a regulation under section 515(b) of the act requiring premarket approval for a device, section 501(f)(1)(A) of the act applies to the device.

(b) Any new, not substantially equivalent, device introduced into commercial distribution on or after May 28, 1976, including a device formerly marketed that has been substantially altered, is classified by statute (section 513(f) of the act) into class III without any grace period and FDA must have issued an order approving a PMA or declaring completed a PDP for the device before the device is commercially distributed unless it is reclassified. If FDA knows that a device being commercially distributed may be a "new" device as defined in this section because of any new intended use or other reasons, FDA may codify the statutory classification of the device into class III for such new use. Accordingly, the regulation for such a class III device states that as of the enactment date of the amendments, May 28, 1976, the device must have an approval under section 515 of the act before commercial distribution.

[52 FR 17741, May 11, 1987]

**§ 890.9 Limitations of exemptions from section 510(k) of the Federal Food, Drug, and Cosmetic Act (the act).**

The exemption from the requirement of premarket notification (section 510(k) of the act) for a generic type of class I or II device is only to the extent that the device has existing or reasonably foreseeable characteristics of commercially distributed devices within that generic type or, in the case of in vitro diagnostic devices, only to the extent that misdiagnosis as a result of using the device would not be associated with high morbidity or mortality. Accordingly, manufacturers of any commercially distributed class I or II device for which FDA has granted an exemption from the requirement of premarket notification must still submit a premarket notification to FDA before introducing or delivering for introduction into interstate commerce for commercial distribution the device when:

(a) The device is intended for a use different from the intended use of a legally marketed device in that generic type of device; e.g., the device is intended for a different medical purpose, or the device is intended for lay use where the former intended use was by health care professionals only;

(b) The modified device operates using a different fundamental scientific technology than a legally marketed device in that generic type of device; e.g., a surgical instrument cuts tissue with a laser beam rather than with a sharpened metal blade, or an in vitro diagnostic device detects or identifies infectious agents by using deoxyribonucleic acid (DNA) probe or nucleic acid hybridization technology rather than culture or immunoassay technology; or

(c) The device is an in vitro device that is intended:

(1) For use in the diagnosis, monitoring, or screening of neoplastic diseases with the exception of immunohistochemical devices;

(2) For use in screening or diagnosis of familial or acquired genetic disorders, including inborn errors of metabolism;

(3) For measuring an analyte that serves as a surrogate marker for screening, diagnosis, or monitoring

life-threatening diseases such as acquired immune deficiency syndrome (AIDS), chronic or active hepatitis, tuberculosis, or myocardial infarction or to monitor therapy;

(4) For assessing the risk of cardiovascular diseases;

(5) For use in diabetes management;

(6) For identifying or inferring the identity of a microorganism directly from clinical material;

(7) For detection of antibodies to microorganisms other than immunoglobulin G (IgG) or IgG assays when the results are not qualitative, or are used to determine immunity, or the assay is intended for use in matrices other than serum or plasma;

(8) For noninvasive testing as defined in § 812.3(k) of this chapter; and

(9) For near patient testing (point of care).

[65 FR 2321, Jan. 14, 2000]

**Subpart B—Physical Medicine Diagnostic Devices**

**§ 890.1175 Electrode cable.**

(a) *Identification.* An electrode cable is a device composed of strands of insulated electrical conductors laid together around a central core and intended for medical purposes to connect an electrode from a patient to a diagnostic machine.

(b) *Classification.* Class II (special controls). The special controls consist of:

(1) The performance standard under part 898 of this chapter, and

(2) The guidance document entitled “Guidance on the Performance Standard for Electrode Lead Wires and Patient Cables.” This device is exempt from the premarket notification procedures of subpart E of part 807 of this chapter subject to § 890.9.

[48 FR 53047, Nov. 23, 1983, as amended at 59 FR 63014, Dec. 7, 1994; 65 FR 19319, Apr. 11, 2000]

**§ 890.1225 Chronaximeter.**

(a) *Identification.* A chronaximeter is a device intended for medical purposes to measure neuromuscular excitability by means of a strength-duration curve that provides a basis for diagnosis and prognosis of neurological dysfunction.

## § 890.1375

(b) *Classification.* Class II (performance standards).

### § 890.1375 Diagnostic electromyograph.

(a) *Identification.* A diagnostic electromyograph is a device intended for medical purposes, such as to monitor and display the bioelectric signals produced by muscles, to stimulate peripheral nerves, and to monitor and display the electrical activity produced by nerves, for the diagnosis and prognosis of neuromuscular disease.

(b) *Classification.* Class II (performance standards).

### § 890.1385 Diagnostic electromyograph needle electrode.

(a) *Identification.* A diagnostic electromyograph needle electrode is a monopolar or bipolar needle intended to be inserted into muscle or nerve tissue to sense bioelectrical signals. The device is intended for medical purposes for use in connection with electromyography (recording the intrinsic electrical properties of skeletal muscle).

(b) *Classification.* Class II (performance standards).

### § 890.1450 Powered reflex hammer.

(a) *Identification.* A powered reflex hammer is a motorized device intended for medical purposes to elicit and determine controlled deep tendon reflexes.

(b) *Classification.* Class II (special controls). The device is exempt from the premarket notification procedures in subpart E of part 807 of this chapter subject to the limitations in § 890.9.

[48 FR 53047, Nov. 23, 1983, as amended at 84 FR 71818, Dec. 30, 2019]

### § 890.1575 Force-measuring platform.

(a) *Identification.* A force-measuring platform is a device intended for medical purposes that converts pressure applied upon a planar surface into analog mechanical or electrical signals. This device is used to determine ground reaction force, centers of percussion, centers of torque, and their variations in both magnitude and direction with time.

(b) *Classification.* Class I (general controls). The device is exempt from the

## 21 CFR Ch. I (4–1–20 Edition)

premarket notification procedures in subpart E of part 807 of this chapter, subject to the limitations in § 890.9.

[48 FR 53047, Nov. 23, 1983, as amended at 61 FR 1125, Jan. 16, 1996; 66 FR 38816, July 25, 2001]

### § 890.1600 Intermittent pressure measurement system.

(a) *Identification.* An intermittent pressure measurement system is an evaluative device intended for medical purposes, such as to measure the actual pressure between the body surface and the supporting media.

(b) *Classification.* Class I (general controls). The device is exempt from the premarket notification procedures in subpart E of part 807 of this chapter, subject to the limitations in § 890.9.

[48 FR 53047, Nov. 23, 1983, as amended at 61 FR 1125, Jan. 16, 1996; 66 FR 38816, July 25, 2001]

### § 890.1615 Miniature pressure transducer.

(a) *Identification.* A miniature pressure transducer is a device intended for medical purposes to measure the pressure between a device and soft tissue by converting mechanical inputs to analog electrical signals.

(b) *Classification.* Class I (general controls). The device is exempt from the premarket notification procedures in subpart E of part 807 of this chapter, subject to the limitations in § 890.9.

[48 FR 53047, Nov. 23, 1983, as amended at 61 FR 1125, Jan. 16, 1996; 66 FR 38816, July 25, 2001]

### § 890.1850 Diagnostic muscle stimulator.

(a) *Identification.* A diagnostic muscle stimulator is a device used mainly with an electromyograph machine to initiate muscle activity. It is intended for medical purposes, such as to diagnose motor nerve or sensory neuromuscular disorders and neuromuscular function.

(b) *Classification.* Class II (performance standards).

### § 890.1925 Isokinetic testing and evaluation system.

(a) *Identification.* An isokinetic testing and evaluation system is a rehabilitative exercise device intended for medical purposes, such as to measure,



evaluate, and increase the strength of muscles and the range of motion of joints.

(b) *Classification.* Class II (special controls). The device is exempt from the premarket notification procedures in subpart E of part 807 of this chapter subject to § 890.9.

[48 FR 53047, Nov. 23, 1983, as amended at 63 FR 59230, Nov. 3, 1998]

### Subpart C [Reserved]

### Subpart D—Physical Medicine Prosthetic Devices

#### § 890.3025 Prosthetic and orthotic accessory.

(a) *Identification.* A prosthetic and orthotic accessory is a device intended for medical purposes to support, protect, or aid in the use of a cast, orthosis (brace), or prosthesis. Examples of prosthetic and orthotic accessories include the following: A pelvic support band and belt, a cast shoe, a cast bandage, a limb cover, a prosthesis alignment device, a postsurgical pylon, a transverse rotator, and a temporary training splint.

(b) *Classification.* Class I (general controls). The device is exempt from the premarket notification procedures in subpart E of part 807 of this chapter, subject to the limitations in § 890.9. The device is also exempt from the current good manufacturing practice requirements of the quality system regulation in part 820 of this chapter, with the exception of § 820.180, regarding general requirements concerning records and § 820.198, regarding complaint files.

[48 FR 53047, Nov. 23, 1983, as amended at 66 FR 38816, July 25, 2001]

#### § 890.3075 Cane.

(a) *Identification.* A cane is a device intended for medical purposes that is used to provide minimal weight support while walking. Examples of canes include the following: A standard cane, a forearm cane, and a cane with a tripod, quad, or retractable stud on the ground end.

(b) *Classification.* Class I (general controls). The device is exempt from the premarket notification procedures in subpart E of part 807 of this chapter,

subject to the limitations in § 890.9. The device is also exempt from the current good manufacturing practice requirements of the quality system regulation in part 820 of this chapter, with the exception of § 820.180, regarding general requirements concerning records and § 820.198, regarding complaint files.

[48 FR 53047, Nov. 23, 1983, as amended at 66 FR 38816, July 25, 2001]

#### § 890.3100 Mechanical chair.

(a) *Identification.* A mechanical chair is a manually operated device intended for medical purposes that is used to assist a disabled person in performing an activity that the person would otherwise find difficult to do or be unable to do. Examples of mechanical chairs include the following: A chair with an elevating seat used to raise a person from a sitting position to a standing position and a chair with casters used by a person to move from one place to another while sitting.

(b) *Classification.* Class I (general controls). The device is exempt from the premarket notification procedures in subpart E of part 807 of this chapter, subject to the limitations in § 890.9.

[48 FR 53047, Nov. 23, 1983, as amended at 59 FR 63014, Dec. 7, 1994; 66 FR 38816, July 25, 2001]

#### § 890.3110 Electric positioning chair.

(a) *Identification.* An electric positioning chair is a device with a motorized positioning control that is intended for medical purposes and that can be adjusted to various positions. The device is used to provide stability for patients with athetosis (involuntary spasms) and to alter postural positions.

(b) *Classification.* Class II. The electric positioning chair is exempt from premarket notification procedures in subpart E of part 807 of this chapter, subject to § 890.9 and the following conditions for exemption:

(1) Appropriate analysis and non-clinical testing must demonstrate that the safety controls are adequate to ensure safe use of the device and prevent user falls from the device in the event of a device failure;

## § 890.3150

(2) Appropriate analysis and non-clinical testing must demonstrate the ability of the device to withstand the rated user weight load with an appropriate factor of safety;

(3) Appropriate analysis and non-clinical testing must demonstrate the longevity of the device to withstand external forces applied to the device and provide the user with an expected service life of the device;

(4) Appropriate analysis and non-clinical testing must demonstrate proper environments of use and storage of the device to maximize the longevity of the device;

(5) Appropriate analysis and non-clinical testing (such as that outlined in the currently FDA-recognized editions of ANSI/AAMI/ES60601-1, "Medical Electrical Equipment—Part 1: General Requirements for Basic Safety and Essential Performance," and ANSI/AAMI/IEC 60601-1-2, "Medical Electrical Equipment—Part 1-2: General Requirements for Basic Safety and Essential Performance—Collateral Standard: Electromagnetic Disturbances—Requirements and Tests") must validate electromagnetic compatibility and electrical safety;

(6) Appropriate analysis and non-clinical testing (such as that outlined in the currently FDA-recognized editions of ANSI/AAMI/ISO 10993-1, "Biological Evaluation of Medical Devices—Part 1: Evaluation and Testing Within a Risk Management Process," ANSI/AAMI/ISO 10993-5, "Biological Evaluation of Medical Devices—Part 5: Tests for In Vitro Cytotoxicity," and ANSI/AAMI/ISO 10993-10, "Biological Evaluation of Medical Devices—Part 10: Tests for Irritation and Skin Sensitization") must validate that the skin-contacting components of the device are biocompatible;

(7) Appropriate analysis and non-clinical testing (such as that outlined in the currently FDA-recognized editions of IEC 62304, "Medical Device Software—Software Life Cycle Processes") must validate the software life cycle and that all processes, activities, and tasks are implemented and documented;

(8) Appropriate analysis and non-clinical testing must validate that the de-

## 21 CFR Ch. I (4-1-20 Edition)

vice components are found to be non-flammable;

(9) Appropriate analysis and non-clinical testing must validate that the battery in the device (if applicable) performs as intended over the anticipated service life of the device; and

(10) Adequate patient labeling is provided to the user to document proper use and maintenance of the device to ensure safe use of the device by the patient in the intended use environment.

[48 FR 53047, Nov. 23, 1983, as amended at 80 FR 72950, Nov. 20, 2015]

### § 890.3150 Crutch.

(a) *Identification.* A crutch is a device intended for medical purposes for use by disabled persons to provide minimal to moderate weight support while walking.

(b) *Classification.* Class I (general controls). The device is exempt from the premarket notification procedures in subpart E of part 807 of this chapter, subject to the limitations in § 890.9. The device is also exempt from the current good manufacturing practice requirements of the quality system regulation in part 820 of this chapter, with the exception of § 820.180, regarding general requirements concerning records and § 820.198, regarding complaint files.

[48 FR 53047, Nov. 23, 1983, as amended at 66 FR 38816, July 25, 2001]

### § 890.3175 Flotation cushion.

(a) *Identification.* A flotation cushion is a device intended for medical purposes that is made of plastic, rubber, or other type of covering, that is filled with water, air, gel, mud, or any other substance allowing a flotation media, used on a seat to lessen the likelihood of skin ulcers.

(b) *Classification.* Class I (general controls). The device is exempt from the premarket notification procedures in subpart E of part 807 of this chapter, subject to the limitations in § 890.9.

[48 FR 53047, Nov. 23, 1983, as amended at 61 FR 1125, Jan. 16, 1996; 66 FR 38816, July 25, 2001]

**§ 890.3410 External limb orthotic component.**

(a) *Identification.* An external limb orthotic component is a device intended for medical purposes for use in conjunction with an orthosis (brace) to increase the function of the orthosis for a patient's particular needs. Examples of external limb orthotic components include the following: A brace-setting twister and an external brace stirrup.

(b) *Classification.* Class I (general controls). The device is exempt from the premarket notification procedures in subpart E of part 807 of this chapter, subject to the limitations in § 890.9. The device is also exempt from the current good manufacturing practice requirements of the quality system regulation in part 820 of this chapter, with the exception of § 820.180, regarding general requirements concerning records and § 820.198, regarding complaint files.

[48 FR 53047, Nov. 23, 1983, as amended at 66 FR 38816, July 25, 2001]

**§ 890.3420 External limb prosthetic component.**

(a) *Identification.* An external limb prosthetic component is a device intended for medical purposes that, when put together with other appropriate components, constitutes a total prosthesis. Examples of external limb prosthetic components include the following: Ankle, foot, hip, knee, and socket components; mechanical or powered hand, hook, wrist unit, elbow joint, and shoulder joint components; and cable and prosthesis suction valves.

(b) *Classification.* Class I (general controls). The device is exempt from the premarket notification procedures in subpart E of part 807 of this chapter, subject to the limitations in § 890.9. The device is also exempt from the current good manufacturing practice requirements of the quality system regulation in part 820 of this chapter, with the exception of § 820.180, regarding general requirements concerning records and § 820.198, regarding complaint files.

[48 FR 53047, Nov. 23, 1983, as amended at 66 FR 38816, July 25, 2001]

**§ 890.3450 Upper extremity prosthesis including a simultaneously powered elbow and/or shoulder with greater than two simultaneous powered degrees of freedom and controlled by non-implanted electrical components.**

(a) *Identification.* A upper extremity prosthesis including a simultaneously powered elbow and/or shoulder with greater than two simultaneous powered degrees of freedom and controlled by non-implanted electrical components, is a prescription device intended for medical purposes, and is intended to replace a partially or fully amputated or congenitally absent upper extremity. It uses electronic inputs (other than simple, manually controlled electrical components such as switches) to provide greater than two independent and simultaneously powered degrees of freedom and includes a simultaneously powered elbow and/or shoulder. Prosthetic arm components that are intended to be used as a system with other arm components must include all degrees of freedom of the total upper extremity prosthesis system.

(b) *Classification.* Class II (special controls). The special controls for this device are:

(1) Appropriate analysis/testing must validate electronic compatibility, electrical safety, thermal safety, mechanical safety, battery performance and safety, and wireless performance, if applicable.

(2) Appropriate software verification, validation, and hazard analysis must be performed.

(3) Non-clinical performance data must demonstrate that the device performs as intended under anticipated conditions of use. Performance testing must include:

(i) Mechanical bench data, including durability testing, to demonstrate that the device will withstand forces, conditions, and environments encountered during use.

(ii) Simulated use testing to demonstrate performance of arm commands and available safeguard(s) under worst case conditions and after durability testing.

(iii) Verification and validation of force sensors and hand release button, if applicable, are necessary.

(iv) Device functionality in terms of flame retardant materials, liquid/particle ingress prevention, sensor and actuator performance, and motor and brake performance.

(v) The accuracy of the device features and safeguards.

(4) Non-clinical and clinical performance testing must demonstrate the accuracy of device features and safeguards.

(5) Elements of the device that may contact the patient must be demonstrated to be biocompatible.

(6) Documented clinical experience and human factors testing must demonstrate safe and effective use, capture any adverse events observed during clinical use and demonstrate the accuracy of device features and safeguards.

(7) Labeling for the Prosthetist and User Guide must include:

(i) Appropriate instructions, warning, cautions, limitations, and information related to the necessary safeguards of the device, including warning against activities that may put the user at greater risk (*e.g.*, driving).

(ii) Specific instructions and the clinical training needed for the safe use of the device, which includes:

(A) Instructions on assembling the device in all available configurations,

(B) Instructions on fitting the patient,

(C) Instructions and explanations of all available programs and how to program the device,

(D) Instructions and explanation of all controls, input, and outputs,

(E) Instructions on all available modes or states of the device,

(F) Instructions on all safety features of the device, and

(G) Instructions for maintaining the device.

(iii) Information on the patient population for which the device has been demonstrated to be effective.

(iv) A detailed summary of the non-clinical and clinical testing pertinent to use of the device.

[81 FR 71612, Oct. 18, 2016]

#### § 890.3475 Limb orthosis.

(a) *Identification.* A limb orthosis (brace) is a device intended for medical purposes that is worn on the upper or lower extremities to support, to cor-

rect, or to prevent deformities or to align body structures for functional improvement. Examples of limb orthoses include the following: A whole limb and joint brace, a hand splint, an elastic stocking, a knee cage, and a corrective shoe.

(b) *Classification.* Class I (general controls). The device is exempt from the premarket notification procedures in subpart E of part 807 of this chapter, subject to the limitations in § 890.9. The device is also exempt from the current good manufacturing practice requirements of the quality system regulation in part 820 of this chapter, with the exception of § 820.180, regarding general requirements concerning records and § 820.198, regarding complaint files.

[48 FR 53047, Nov. 23, 1983, as amended at 66 FR 38816, July 25, 2001]

#### § 890.3480 Powered lower extremity exoskeleton.

(a) *Identification.* A powered lower extremity exoskeleton is a prescription device that is composed of an external, powered, motorized orthosis that is placed over a person's paralyzed or weakened limbs for medical purposes.

(b) *Classification.* Class II (special controls). The special controls for this device are:

(1) Elements of the device materials that may contact the patient must be demonstrated to be biocompatible.

(2) Appropriate analysis/testing must validate electromagnetic compatibility/interference (EMC/EMI), electrical safety, thermal safety, mechanical safety, battery performance and safety, and wireless performance, if applicable.

(3) Appropriate software verification, validation, and hazard analysis must be performed.

(4) Design characteristics must ensure geometry and materials composition are consistent with intended use.

(5) Non-clinical performance testing must demonstrate that the device performs as intended under anticipated conditions of use. Performance testing must include:

(i) Mechanical bench testing (including durability testing) to demonstrate that the device will withstand forces, conditions, and environments encountered during use;

(ii) Simulated use testing (*i.e.*, cyclic loading testing) to demonstrate performance of device commands and safeguard under worst case conditions and after durability testing;

(iii) Verification and validation of manual override controls are necessary, if present;

(iv) The accuracy of device features and safeguards; and

(v) Device functionality in terms of flame retardant materials, liquid/particle ingress prevention, sensor and actuator performance, and motor performance.

(6) Clinical testing must demonstrate a reasonable assurance of safe and effective use and capture any adverse events observed during clinical use when used under the proposed conditions of use, which must include considerations for:

(i) Level of supervision necessary, and

(ii) Environment of use (*e.g.*, indoors and/or outdoors) including obstacles and terrain representative of the intended use environment.

(7) A training program must be included with sufficient educational elements so that upon completion of training program, the clinician, user, and companion can:

(i) Identify the safe environments for device use,

(ii) Use all safety features of device, and

(iii) Operate the device in simulated or actual use environments representative of indicated environments and use.

(8) Labeling for the Physician and User must include the following:

(i) Appropriate instructions, warning, cautions, limitations, and information related to the necessary safeguards of the device, including warning against activities and environments that may put the user at greater risk.

(ii) Specific instructions and the clinical training needed for the safe use of the device, which includes:

(A) Instructions on assembling the device in all available configurations;

(B) Instructions on fitting the patient;

(C) Instructions and explanations of all available programs and how to program the device;

(D) Instructions and explanation of all controls, input, and outputs;

(E) Instructions on all available modes or states of the device;

(F) Instructions on all safety features of the device; and

(G) Instructions for properly maintaining the device.

(iii) Information on the patient population for which the device has been demonstrated to have a reasonable assurance of safety and effectiveness.

(iv) Pertinent non-clinical testing information (*e.g.*, EMC, battery longevity).

(v) A detailed summary of the clinical testing including:

(A) Adverse events encountered under use conditions,

(B) Summary of study outcomes and endpoints, and

(C) Information pertinent to use of the device including the conditions under which the device was studied (*e.g.*, level of supervision or assistance, and environment of use (*e.g.*, indoors and/or outdoors) including obstacles and terrain).

[80 FR 25529, May 4, 2015]

#### § 890.3490 Truncal orthosis.

(a) *Identification.* A truncal orthosis is a device intended for medical purposes to support or to immobilize fractures, strains, or sprains of the neck or trunk of the body. Examples of truncal orthoses are the following: Abdominal, cervical, cervical-thoracic, lumbar, lumbo-sacral, rib fracture, sacroiliac, and thoracic orthoses and clavicle splints.

(b) *Classification.* Class I (general controls). The device is exempt from the premarket notification procedures in subpart E of part 807 of this chapter, subject to the limitations in § 890.9. The device is also exempt from the current good manufacturing practice requirements of the quality system regulation in part 820 of this chapter, with the exception of § 820.180, regarding general requirements concerning records and § 820.198, regarding complaint files.

[48 FR 53047, Nov. 23, 1983, as amended at 66 FR 38816, July 25, 2001]

## § 890.3500

## 21 CFR Ch. I (4–1–20 Edition)

### § 890.3500 External assembled lower limb prosthesis.

(a) *Identification.* An external assembled lower limb prosthesis is a device that is intended for medical purposes and is a preassembled external artificial limb for the lower extremity. Examples of external assembled lower limb prostheses are the following: Knee/shank/ankle/foot assembly and thigh/knee/shank/ankle/foot assembly.

(b) *Classification.* Class II (special controls). The device is exempt from the premarket notification procedures in subpart E of part 807 of this chapter subject to § 890.9.

[48 FR 53047, Nov. 23, 1983, as amended at 63 FR 59231, Nov. 3, 1998]

### § 890.3520 Plinth.

(a) *Identification.* A plinth is a flat, padded board with legs that is intended for medical purposes. A patient is placed on the device for treatment or examination.

(b) *Classification.* Class I (general controls). The device is exempt from the premarket notification procedures in subpart E of part 807 of this chapter, subject to the limitations in § 890.9. The device is also exempt from the current good manufacturing practice requirements of the quality system regulation in part 820 of this chapter, with the exception of § 820.180, regarding general requirements concerning records and § 820.198, regarding complaint files.

[48 FR 53047, Nov. 23, 1983, as amended at 66 FR 38817, July 25, 2001]

### § 890.3610 Rigid pneumatic structure orthosis.

(a) *Identification.* A rigid pneumatic structure orthosis is a device intended for medical purposes to provide whole body support by means of a pressurized suit to help thoracic paraplegics walk.

(b) *Classification.* Class III (premarket approval).

(c) *Date PMA or notice of completion of a PDP is required.* A PMA or a notice of completion of a PDP is required to be filed with the Food and Drug Administration on or before December 26, 1996 for any rigid pneumatic structure orthosis that was in commercial distribution before May 28, 1976, or that has, on or before December 26, 1996 been found

to be substantially equivalent to a rigid pneumatic structure orthosis that was in commercial distribution before May 28, 1976. Any other rigid pneumatic structure orthosis shall have an approved PMA or a declared completed PDP in effect before being placed in commercial distribution.

[48 FR 53047, Nov. 23, 1983, as amended at 52 FR 17742, May 11, 1987; 61 FR 50711, Sept. 27, 1996]

### § 890.3640 Arm sling.

(a) *Identification.* An arm sling is a device intended for medical purposes to immobilize the arm, by means of a fabric band suspended from around the neck.

(b) *Classification.* Class I (general controls). The device is exempt from the premarket notification procedures in subpart E of part 807 of this chapter, subject to the limitations in § 890.9. The device is also exempt from the current good manufacturing practice requirements of the quality system regulation in part 820 of this chapter, with the exception of § 820.180, regarding general requirements concerning records and § 820.198, regarding complaint files.

[48 FR 53047, Nov. 23, 1983, as amended at 66 FR 38817, July 25, 2001]

### § 890.3665 Congenital hip dislocation abduction splint.

(a) *Identification.* A congenital hip dislocation abduction splint is a device intended for medical purposes to stabilize the hips of a young child with dislocated hips in an abducted position (away from the midline).

(b) *Classification.* Class I (general controls). The device is exempt from the premarket notification procedures in subpart E of part 807 of this chapter, subject to the limitations in § 890.9. The device is also exempt from the current good manufacturing practice requirements of the quality system regulation in part 820 of this chapter, with the exception of § 820.180, regarding general requirements concerning records and § 820.198, regarding complaint files.

[48 FR 53047, Nov. 23, 1983, as amended at 66 FR 38817, July 25, 2001]

**§ 890.3675 Denis Brown splint.**

(a) *Identification.* A Denis Brown splint is a device intended for medical purposes to immobilize the foot. It is used on young children with tibial torsion (excessive rotation of the lower leg) or club foot.

(b) *Classification.* Class I (general controls). The device is exempt from the premarket notification procedures in subpart E of part 807 of this chapter, subject to the limitations in § 890.9. The device is also exempt from the current good manufacturing practice requirements of the quality system regulation in part 820 of this chapter, with the exception of § 820.180, regarding general requirements concerning records and § 820.198, regarding complaint files.

[48 FR 53047, Nov. 23, 1983, as amended at 66 FR 38817, July 25, 2001]

**§ 890.3690 Powered wheeled stretcher.**

(a) *Identification.* A powered wheeled stretcher is a battery-powered table with wheels that is intended for medical purposes for use by patients who are unable to propel themselves independently and who must maintain a prone or supine position for prolonged periods because of skin ulcers or contractures (muscle contractions).

(b) *Classification.* Class II (performance standards). The powered wheeled stretcher is exempt from premarket notification procedures in subpart E of part 807 of this chapter, subject to § 890.9, and the following conditions for exemption:

(1) Appropriate analysis and nonclinical testing must demonstrate that the safety controls are adequate to ensure safe use of the device and prevent user falls from the device in the event of a device failure;

(2) Appropriate analysis and nonclinical testing must demonstrate the ability of the device to withstand the rated user weight load with an appropriate factor of safety;

(3) Appropriate analysis and nonclinical testing must demonstrate the longevity of the device to withstand external forces applied to the device and provide the user with an expected service life of the device;

(4) Appropriate analysis and nonclinical testing must demonstrate proper

environments of use and storage of the device to maximize the longevity of the device;

(5) Appropriate analysis and nonclinical testing (such as outlined in appropriate FDA-recognized consensus standards) must validate electromagnetic compatibility and electrical safety;

(6) Appropriate analysis and nonclinical testing (such as outlined in appropriate FDA-recognized consensus standards) must validate that the skin-contacting components of the device are biocompatible;

(7) Appropriate analysis and nonclinical testing (such as outlined in appropriate FDA-recognized consensus standards) must validate the software life cycle and that all processes, activities, and tasks are implemented and documented;

(8) Appropriate analysis and nonclinical testing must validate that the device components are found to be non-flammable;

(9) Appropriate analysis and nonclinical testing (such as outlined in appropriate FDA-recognized consensus standards) must validate that the battery in the device performs as intended over the anticipated service life of the device;

(10) Adequate labeling is provided to the user to document proper use and maintenance of the device to ensure safe use of the device in the intended use environment; and

(11) Appropriate risk assessment including, but not limited to, evaluating the dimensional limits of the gaps in hospital beds, and mitigation strategy to reduce entrapment.

[48 FR 53047, Nov. 23, 1983, as amended at 85 FR 2020, Jan. 14, 2020]

**§ 890.3700 Nonpowered communication system.**

(a) *Identification.* A nonpowered communication system is a mechanical device intended for medical purposes that is used to assist a patient in communicating when physical impairment prevents writing, telephone use, reading, or talking. Examples of nonpowered communications systems include an alphabet board and a page turner.

(b) *Classification.* Class I (general controls). The device is exempt from the

## § 890.3710

premarket notification procedures in subpart E of part 807 of this chapter, subject to the limitations in § 890.9. The device is also exempt from the current good manufacturing practice requirements of the quality system regulation in part 820 of this chapter, with the exception of § 820.180, regarding general requirements concerning records and § 820.198, regarding complaint files.

[48 FR 53047, Nov. 23, 1983, as amended at 54 FR 25052, June 12, 1989; 66 FR 38817, July 25, 2001]

## § 890.3710 Powered communication system.

(a) *Identification.* A powered communication system is an AC- or battery-powered device intended for medical purposes that is used to transmit or receive information. It is used by persons unable to use normal communication methods because of physical impairment. Examples of powered communication systems include the following: a specialized typewriter, a reading machine, and a video picture and word screen.

(b) *Classification.* Class II (special controls). The device is exempt from the premarket notification procedures in subpart E of part 807 of this chapter subject to § 890.9.

[48 FR 53047, Nov. 23, 1983, as amended at 63 FR 59231, Nov. 3, 1998]

## § 890.3725 Powered environmental control system.

(a) *Identification.* A powered environmental control system is an AC- or battery-powered device intended for medical purposes that is used by a patient to operate an environmental control function. Examples of environmental control functions include the following: to control room temperature, to answer a doorbell or telephone, or to sound an alarm for assistance.

(b) *Classification.* Class II (special controls). The device is exempt from the premarket notification procedures in subpart E of part 807 of this chapter subject to § 890.9.

[48 FR 53047, Nov. 23, 1983, as amended at 63 FR 59231, Nov. 3, 1998]

## 21 CFR Ch. I (4–1–20 Edition)

## § 890.3750 Mechanical table.

(a) *Identification.* A mechanical table is a device intended for medical purposes that has a flat surface that can be inclined or adjusted to various positions. It is used by patients with circulatory, neurological, or musculoskeletal conditions to increase tolerance to an upright or standing position.

(b) *Classification.* Class I (general controls). The device is exempt from the premarket notification procedures in subpart E of part 807 of this chapter, subject to the limitations in § 890.9.

[48 FR 53047, Nov. 23, 1983, as amended at 59 FR 63014, Dec. 7, 1994; 66 FR 38817, July 25, 2001]

## § 890.3760 Powered table.

(a) *Identification.* A powered table is a device intended for medical purposes that is an electrically operated flat surface table that can be adjusted to various positions. It is used by patients with circulatory, neurological, or musculoskeletal conditions to increase tolerance to an upright or standing position.

(b) *Classification.* Class I (general controls). The device is exempt from the premarket notification procedures in subpart E of part 807 of this chapter, subject to the limitations in § 890.9.

[48 FR 53047, Nov. 23, 1983, as amended at 61 FR 1125, Jan. 16, 1996; 66 FR 38817, July 25, 2001]

## § 890.3790 Cane, crutch, and walker tips and pads.

(a) *Identification.* Cane, crutch, and walker tips and pads are rubber (or rubber substitute) device accessories intended for medical purposes that are applied to the ground end of mobility aids to prevent skidding or that are applied to the body contact area of the device for comfort or as an aid in using an ambulatory assist device.

(b) *Classification.* Class I (general controls). The device is exempt from the premarket notification procedures in subpart E of part 807 of this chapter, subject to the limitations in § 890.9. The device is also exempt from the current good manufacturing practice requirements of the quality system regulation



## Food and Drug Administration, HHS

## § 890.3890

in part 820 of this chapter, with the exception of § 820.180, regarding general requirements concerning records and § 820.198, regarding complaint files.

[48 FR 53047, Nov. 23, 1983, as amended at 66 FR 38817, July 25, 2001]

### § 890.3800 Motorized three-wheeled vehicle.

(a) *Identification.* A motorized three-wheeled vehicle is a gasoline-fueled or battery-powered device intended for medical purposes that is used for outside transportation by disabled persons.

(b) *Classification.* Class II (performance standards).

### § 890.3825 Mechanical walker.

(a) *Identification.* A mechanical walker is a four-legged device with a metal frame intended for medical purposes to provide moderate weight support while walking. It is used by disabled persons who lack strength, good balance, or endurance.

(b) *Classification.* Class I (general controls). The device is exempt from the premarket notification procedures in subpart E of part 807 of this chapter, subject to the limitations in § 890.9. The device is also exempt from the current good manufacturing practice requirements of the quality system regulation in part 820 of this chapter, with the exception of § 820.180, regarding general requirements concerning records and § 820.198, regarding complaint files.

[48 FR 53047, Nov. 23, 1983, as amended at 66 FR 38817, July 25, 2001]

### § 890.3850 Mechanical wheelchair.

(a) *Identification.* A mechanical wheelchair is a manually operated device with wheels that is intended for medical purposes to provide mobility to persons restricted to a sitting position.

(b) *Classification.* Class I (general controls).

### § 890.3860 Powered wheelchair.

(a) *Identification.* A powered wheelchair is a battery-operated device with wheels that is intended for medical purposes to provide mobility to persons restricted to a sitting position.

(b) *Classification.* Class II (performance standards).

### § 890.3880 Special grade wheelchair.

(a) *Identification.* A special grade wheelchair is a device with wheels that is intended for medical purposes to provide mobility to persons restricted to a sitting position. It is intended to be used in all environments for long-term use, e.g., for paraplegics, quadraplegics, and amputees.

(b) *Classification.* Class II (performance standards).

### § 890.3890 Stair-climbing wheelchair.

(a) *Identification.* A stair-climbing wheelchair is a device with wheels that is intended for medical purposes to provide mobility to persons restricted to a sitting position. The device is intended to climb stairs.

(b) *Classification.* Class II (special controls). The special controls for this device are:

(1) The design characteristics of the device must ensure that the geometry and material composition are consistent with the intended use.

(2) Performance testing must demonstrate adequate mechanical performance under simulated use conditions and environments. Performance testing must include the following:

- (i) Fatigue testing;
- (ii) Resistance to dynamic loads (impact testing);
- (iii) Effective use of the braking mechanism and how the device stops in case of an electrical brake failure;
- (iv) Demonstration of adequate stability of the device on inclined planes (forward, backward, and lateral);
- (v) Demonstration of the ability of the device to safely ascend and descend obstacles (i.e., stairs, curb); and
- (vi) Demonstration of ability to effectively use the device during adverse temperatures and following storage in adverse temperatures and humidity conditions.

(3) The skin-contacting components of the device must be demonstrated to be biocompatible.

(4) Software design, verification, and validation must demonstrate that the device controls, alarms, and user interfaces function as intended.

(4) Software design, verification, and validation must demonstrate that the device controls, alarms, and user interfaces function as intended.

## § 890.3900

(5) Appropriate analysis and performance testing must be conducted to verify electrical safety and electromagnetic compatibility of the device.

(6) Performance testing must demonstrate battery safety and evaluate longevity.

(7) Performance testing must evaluate the flammability of device components.

(8) Patient labeling must bear all information required for the safe and effective use of the device, specifically including the following:

(i) A clear description of the technological features of the device and the principles of how the device works;

(ii) A clear description of the appropriate use environments/conditions, including prohibited environments;

(iii) Preventive maintenance recommendations;

(iv) Operating specifications for proper use of the device such as patient weight limitations, device width, and clearance for maneuverability; and

(v) A detailed summary of the device-related adverse events and how to report any complications.

(9) Clinician labeling must include all the information in the Patient labeling noted in paragraph (b)(8) of this section but must also include the following:

(i) Identification of patients who can effectively operate the device; and

(ii) Instructions on how to fit, modify, or calibrate the device.

(10) Usability studies of the device must demonstrate that the device can be used by the patient in the intended use environment with the instructions for use and user training.

[79 FR 20782, Apr. 14, 2014]

### § 890.3900 Standup wheelchair.

(a) *Identification.* A standup wheelchair is a device with wheels that is intended for medical purposes to provide mobility to persons restricted to a sitting position. The device incorporates an external manually controlled mechanical system that is intended to raise a paraplegic to an upright position by means of an elevating seat.

(b) *Classification.* Class II (performance standards).

## 21 CFR Ch. I (4–1–20 Edition)

### § 890.3910 Wheelchair accessory.

(a) *Identification.* A wheelchair accessory is a device intended for medical purposes that is sold separately from a wheelchair and is intended to meet the specific needs of a patient who uses a wheelchair. Examples of wheelchair accessories include but are not limited to the following: armboard, lapboard, pusher cuff, crutch and cane holder, overhead suspension sling, head and trunk support, and blanket and leg rest strap.

(b) *Classification.* Class I (general controls). If the device is not intended for use as a protective restraint as defined in § 880.6760 of this chapter, it is exempt from the premarket notification procedures in subpart E of part 807 of this chapter, subject to the limitations in § 890.9. The device is also exempt from the current good manufacturing practice requirements of the quality system regulation in part 820 of this chapter, with the exception of § 820.180, regarding general requirements concerning records, and § 820.198, regarding complaint files.

[61 FR 8439, Mar. 4, 1996, as amended at 66 FR 38817, July 25, 2001]

### § 890.3920 Wheelchair component.

(a) *Identification.* A wheelchair component is a device intended for medical purposes that is generally sold as an integral part of a wheelchair, but may also be sold separately as a replacement part. Examples of wheelchair components are the following: Armrest, narrowing attachment, belt, extension brake, curb climber, cushion, antitip device, footrest, handrim, hill holder, leg rest, heel loops, and toe loops.

(b) *Classification.* Class I (general controls). The device is exempt from the premarket notification procedures in subpart E of part 807 of this chapter, subject to the limitations in § 890.9.

[48 FR 53047, Nov. 23, 1983, as amended at 59 FR 63014, Dec. 7, 1994; 66 FR 38817, July 25, 2001]

### § 890.3930 Wheelchair elevator.

(a) *Permanently mounted wheelchair platform lift—(1) Identification.* A permanently mounted wheelchair platform lift is a motorized vertical or inclined

platform lift device permanently installed in one location that is intended for use in mitigating mobility impairment caused by injury or other disease by providing a guided platform to move a person from one level to another, with or without a wheelchair.

(2) *Classification*. Class II. The permanently mounted wheelchair platform lift is exempt from premarket notification procedures in subpart E of part 807 of this chapter, subject to §890.9 and the following conditions for exemption:

(i) Appropriate analysis and nonclinical testing (such as that outlined in the currently FDA-recognized edition of ASME A18.1 “Safety Standard for Platform Lifts and Stairway Chair Lifts”) must demonstrate that the safety controls are adequate to prevent a free fall of the platform in the event of a device failure;

(ii) Appropriate analysis and nonclinical testing (such as that outlined in the currently FDA-recognized edition of ASME A18.1 “Safety Standard for Platform Lifts and Stairway Chair Lifts”) must demonstrate the ability of the device to withstand the rated load with an appropriate factor of safety;

(iii) Appropriate analysis and nonclinical testing (such as that outlined in the currently FDA-recognized edition of ASME A18.1 “Safety Standard for Platform Lifts and Stairway Chair Lifts”) must demonstrate the ability of the enclosures to prevent the user from falling from the device; and

(iv) Appropriate analysis and nonclinical testing (such as that outlined in the currently FDA-recognized editions of AAMI/ANSI/IEC 60601-1-2, “Medical Electrical Equipment—Part 1-2: General Requirements for Safety—Collateral Standard: Electromagnetic Compatibility—Requirements and Tests,” and ASME A18.1 “Safety Standard for Platform Lifts and Stairway Chair Lifts”) must validate electromagnetic compatibility and electrical safety.

(b) *Portable wheelchair elevators*—(1) *Identification*. A portable wheelchair elevator is a motorized lift device that is not permanently mounted in one location and that is intended for use in mitigating mobility impairment caused by injury or other disease by providing a means to move a person,

with or without a wheelchair, from one level to another (e.g., portable platform lifts, attendant-operated stair climbing devices for wheelchairs).

(2) *Classification*. Class II.

[78 FR 14015, Mar. 4, 2013]

#### § 890.3940 Wheelchair platform scale.

(a) *Identification*. A wheelchair platform scale is a device with a base designed to accommodate a wheelchair. It is intended for medical purposes to weigh a person who is confined to a wheelchair.

(b) *Classification*. Class I (general controls). The device is exempt from the premarket notification procedures in subpart E of part 807 of this chapter, subject to the limitations in §890.9. The device is also exempt from the current good manufacturing practice requirements of the quality system regulation in part 820 of this chapter, with the exception of §820.180, regarding general requirements concerning records and §820.198, regarding complaint files.

[48 FR 53047, Nov. 23, 1983, as amended at 59 FR 63015, Dec. 7, 1994; 66 FR 38817, July 25, 2001]

### Subpart E [Reserved]

### Subpart F—Physical Medicine Therapeutic Devices

#### § 890.5050 Daily activity assist device.

(a) *Identification*. A daily activity assist device is a modified adaptor or utensil (e.g., a dressing, grooming, recreational activity, transfer, eating, or homemaking aid) that is intended for medical purposes to assist a patient to perform a specific function.

(b) *Classification*. Class I (general controls). The device is exempt from the premarket notification procedures in subpart E of part 807 of this chapter, subject to the limitations in §890.9. If the device is not labeled or otherwise represented as sterile, the device is also exempt from the current good manufacturing practice requirements of the quality system regulation in

## § 890.5100

part 820 of this chapter, with the exception of § 820.180, regarding general requirements concerning records and § 820.198, regarding complaint files.

[48 FR 53047, Nov. 23, 1983, as amended at 66 FR 38817, July 25, 2001]

### § 890.5100 Immersion hydrobath.

(a) *Identification.* An immersion hydrobath is a device intended for medical purposes that consists of water agitators and that may include a tub to be filled with water. The water temperature may be measured by a gauge. It is used in hydrotherapy to relieve pain and itching and as an aid in the healing process of inflamed and traumatized tissue, and it serves as a setting for removal of contaminated tissue.

(b) *Classification.* Class II (special controls). The device, when it is a hydromassage bath or a powered sitz bath, is exempt from the premarket notification procedures in subpart E of part 807 of this chapter subject to the limitations in § 890.9.

[48 FR 53047, Nov. 23, 1983, as amended at 84 FR 71818, Dec. 30, 2019]

### § 890.5110 Paraffin bath.

(a) *Identification.* A paraffin bath is a device intended for medical purposes that consists of a tub to be filled with liquid paraffin (wax) and maintained at an elevated temperature in which the patient's appendages (e.g., hands or fingers) are placed to relieve pain and stiffness.

(b) *Classification.* Class II (special controls). The device is exempt from the premarket notification procedures in subpart E of part 807 of this chapter subject to the limitations in § 890.9.

[48 FR 53047, Nov. 23, 1983, as amended at 84 FR 71818, Dec. 30, 2019]

### § 890.5125 Nonpowered sitz bath.

(a) *Identification.* A nonpowered sitz bath is a device intended for medical purposes that consists of a tub to be filled with water for use in external hydrotherapy to relieve pain or pruritis and to accelerate the healing of inflamed or traumatized tissues of the perianal and perineal areas.

(b) *Classification.* Class I (general controls). The device is exempt from the

## 21 CFR Ch. I (4–1–20 Edition)

premarket notification procedures in subpart E of part 807 of this chapter, subject to the limitations in § 890.9. The device is also exempt from the current good manufacturing practice requirements of the quality system regulation in part 820 of this chapter, with the exception of § 820.180, regarding general requirements concerning records and § 820.198, regarding complaint files.

[48 FR 53047, Nov. 23, 1983, as amended at 54 FR 25052, June 12, 1989; 66 FR 38818, July 25, 2001]

### § 890.5150 Powered patient transport.

(a) *Powered patient stairway chair lifts—(1) Identification.* A powered patient stairway chair lift is a motorized lift equipped with a seat and permanently mounted in one location that is intended for use in mitigating mobility impairment caused by injury or other disease by moving a person up and down a stairway.

(2) *Classification.* Class II. The stairway chair lift is exempt from premarket notification procedures in subpart E of part 807 of this chapter, subject to § 890.9 and the following conditions for exemption:

(i) Appropriate analysis and nonclinical testing (such as that outlined in the currently FDA-recognized edition of American Society of Mechanical Engineers (ASME) A18.1 “Safety Standard for Platform Lifts and Stairway Chair Lifts”) must demonstrate that the safety controls are adequate to prevent a free fall of the chair in the event of a device failure;

(ii) Appropriate analysis and nonclinical testing must demonstrate the ability of the device, including armrests, to withstand the rated load with an appropriate factor of safety;

(iii) Appropriate restraints must be provided to prevent the user from falling from the device (such as that outlined in the currently FDA-recognized edition of ASME A18.1 “Safety Standard for Platform Lifts and Stairway Chair Lifts”);

(iv) Appropriate analysis and nonclinical testing (such as that outlined in the currently FDA-recognized editions of AAMI/ANSI/IEC 60601–1–2, “Medical Electrical Equipment—Part 1–2: General Requirements for Safety—Collateral Standard: Electromagnetic

## Food and Drug Administration, HHS

## § 890.5250

Compatibility—Requirements and Tests,” and ASME A18.1 “Safety Standard for Platform Lifts and Stairway Chair Lifts”) must validate electromagnetic compatibility and electrical safety; and

(v) Appropriate analysis and nonclinical testing must demonstrate the resistance of the device upholstery to ignition.

(b) *All other powered patient transport*—(1) *Identification*. A powered patient transport is a motorized device intended for use in mitigating mobility impairment caused by injury or other disease by moving a person from one location or level to another, such as up and down flights of stairs (e.g., attendant-operated portable stair-climbing chairs). This generic type of device does not include motorized three-wheeled vehicles or wheelchairs.

(2) *Classification*. Class II.

[78 FR 14017, Mar. 4, 2013]

### § 890.5160 Air-fluidized bed.

(a) *Identification*. An air-fluidized bed is a device employing the circulation of filtered air through ceramic spherules (small, round ceramic objects) that is intended for medical purposes to treat or prevent bedsores, to treat severe or extensive burns, or to aid circulation.

(b) *Classification*. Class II (special controls). The device is exempt from the premarket notification procedures in subpart E of part 807 of this chapter subject to § 890.9.

[48 FR 53047, Nov. 23, 1983, as amended at 63 FR 59231, Nov. 3, 1998]

### § 890.5170 Powered flotation therapy bed.

(a) *Identification*. A powered flotation therapy bed is a device that is equipped with a mattress that contains a large volume of constantly moving water, air, mud, or sand. It is intended for medical purposes to treat or prevent a patient’s bedsores, to treat severe or extensive burns, or to aid circulation. The mattress may be electrically heated.

(b) *Classification*. Class II (special controls). The device is exempt from the premarket notification procedures

in subpart E of part 807 of this chapter subject to § 890.9.

[48 FR 53047, Nov. 23, 1983, as amended at 63 FR 59231, Nov. 3, 1998]

### § 890.5180 Manual patient rotation bed.

(a) *Identification*. A manual patient rotation bed is a device that turns a patient who is restricted to a reclining position. It is intended for medical purposes to treat or prevent bedsores, to treat severe and extensive burns, or to aid circulation.

(b) *Classification*. Class I (general controls). The device is exempt from the premarket notification procedures in subpart E of part 807 of this chapter subject to § 890.9.

[48 FR 53047, Nov. 23, 1983, as amended at 65 FR 2322, Jan. 14, 2000]

### § 890.5225 Powered patient rotation bed.

(a) *Identification*. A powered patient rotation bed is a device that turns a patient who is restricted to a reclining position. It is intended for medical purposes to treat or prevent bedsores, to treat severe and extensive burns, urinary tract blockage, and to aid circulation.

(b) *Classification*. Class II (special controls). The device is exempt from the premarket notification procedures in subpart E of part 807 of this chapter subject to § 890.9.

[48 FR 53047, Nov. 23, 1983, as amended at 63 FR 59231, Nov. 3, 1998]

### § 890.5250 Moist steam cabinet.

(a) *Identification*. A moist steam cabinet is a device intended for medical purposes that delivers a flow of heated, moisturized air to a patient in an enclosed unit. It is used to treat arthritis and fibrosis (a formation of fibrosis tissue) and to increase local blood flow.

(b) *Classification*. Class II (special controls). The device is exempt from the premarket notification procedures in subpart E of part 807 of this chapter subject to the limitations in § 890.9.

[48 FR 53047, Nov. 23, 1983, as amended at 84 FR 71818, Dec. 30, 2019]

§ 890.5275

21 CFR Ch. I (4-1-20 Edition)

§ 890.5275 Microwave diathermy.

(a) *Microwave diathermy for use in applying therapeutic deep heat for selected medical conditions*—(1) *Identification*. A microwave diathermy for use in applying therapeutic deep heat for selected medical conditions is a device that applies to specific areas of the body electromagnetic energy in the microwave frequency bands of 915 megahertz to 2,450 megahertz and that is intended to generate deep heat within body tissues for the treatment of selected medical conditions such as relief of pain, muscle spasms, and joint contractures, but not for the treatment of malignancies.

(2) *Classification*. Class II (performance standards).

(b) *Microwave diathermy for all other uses*—(1) *Identification*. A microwave diathermy for all other uses except for the treatment of malignancies is a device that applies to the body electromagnetic energy in the microwave frequency bands of 915 megahertz to 2,450 megahertz and that is intended for the treatment of medical conditions by means other than the generation of deep heat within body tissues as described in paragraph (a) of this section.

(2) *Classification*. Class III (premarket approval).

(c) *Date PMA or notice of completion of PDP is required*. A PMA or a notice of completion of a PDP for a device described in paragraph (b) of this section is required to be filed with the Food and Drug Administration on or before July 13, 1999, for any microwave diathermy described in paragraph (b) of this section that was in commercial distribution before May 28, 1976, or that has, on or before July 13, 1999, been found to be substantially equivalent to a microwave diathermy described in paragraph (b) of this section that was in commercial distribution before May 28, 1976. Any other microwave diathermy described in paragraph (b) of this section shall have an approved PMA or declared completed PDP in effect before being placed in commercial distribution.

[48 FR 53047, Nov. 23, 1983, as amended at 52 FR 17742, May 11, 1987; 64 FR 18331, Apr. 14, 1999]

§ 890.5290 Shortwave diathermy.

(a) *Shortwave diathermy for use in applying therapeutic deep heat for selected medical conditions*—(1) *Identification*. A shortwave diathermy for use in applying therapeutic deep heat for selected medical conditions is a device that applies to specific areas of the body electromagnetic energy in the radio-frequency (RF) bands of 13.56 megahertz (MHz) or 27.12 MHz and that is intended to generate deep heat within body tissues for the treatment of selected medical conditions such as relief of pain, muscle spasms, and joint contractures, but not for the treatment of malignancies.

(2) *Classification*. Class II (performance standards).

(b) *Nonthermal shortwave therapy*—(1) *Identification*. A nonthermal shortwave therapy is a prescription device that applies to the body pulsed electromagnetic energy in the RF bands of 13.56 MHz or 27.12 MHz and that is intended for adjunctive use in the palliative treatment of postoperative pain and edema of soft tissue by means other than the generation of deep heat within body tissues as described in paragraph (a) of this section.

(2) *Classification: Class II (special controls)*. The device is classified as class II. The special controls for this device are:

(i) Components of the device that come into human contact must be demonstrated to be biocompatible.

(ii) Appropriate analysis/testing must demonstrate that the device is electrically safe and electromagnetically compatible in its intended use environment.

(iii) Non-clinical performance testing must demonstrate that the device performs as intended under anticipated conditions of use. Non-clinical performance testing must characterize the output waveform of the device and demonstrate that the device meets appropriate output performance specifications. The output characteristics and the methods used to determine these characteristics, including the following, must be determined:

- (A) Peak output power;
- (B) Pulse width;
- (C) Pulse frequency;
- (D) Duty cycle;

(E) Characteristics of other types of modulation that may be used;

(F) Average measured output power into the RF antenna/applicator;

(G) Specific absorption rates in saline gel test load or other appropriate model;

(H) Characterization of the electrical and magnetic fields in saline gel test load or other appropriate model for each RF antenna and prescribed RF antenna orientation/position; and

(I) Characterization of the deposited energy density in saline gel test load or other appropriate model.

(iv) A detailed summary of the clinical testing pertinent to use of the device to demonstrate the effectiveness of the device in its intended use.

(v) Labeling must include the following:

(A) Output characteristics of the device;

(B) Recommended treatment regimens, including duration of use; and

(C) A detailed summary of the clinical testing pertinent to the use of the device and a summary of the adverse events and complications.

(vi) Nonthermal shortwave therapy devices marketed prior to the effective date of this reclassification must submit an amendment to their previously cleared premarket notification (510(k)) demonstrating compliance with these special controls.

[48 FR 53047, Nov. 23, 1983, as amended at 52 FR 17742, May 11, 1987; 80 FR 61302, Oct. 13, 2015]

#### § 890.5300 Ultrasonic diathermy.

(a) *Ultrasonic diathermy for use in applying therapeutic deep heat for selected medical conditions*—(1) *Identification*. An ultrasonic diathermy for use in applying therapeutic deep heat for selected medical conditions is a device that applies to specific areas of the body ultrasonic energy at a frequency beyond 20 kilohertz and that is intended to generate deep heat within body tissues for the treatment of selected medical conditions such as relief of pain, muscle spasms, and joint contractures, but not for the treatment of malignancies.

(2) *Classification*. Class II (performance standards).

(b) *Ultrasonic diathermy for all other uses*—(1) *Identification*. An ultrasonic

diathermy for all other uses except for the treatment of malignancies is a device that applies to the body ultrasonic energy at a frequency beyond 20 kilohertz and that is intended for the treatment of medical conditions by means other than the generation of deep heat within body tissues as described in paragraph (a) of this section.

(2) *Classification*. Class III (premarket approval).

(c) *Date PMA or notice of completion of PDP is required*. A PMA or notice of completion of a PDP for a device described in paragraph (b) of this section is required to be filed with the Food and Drug Administration on or before July 13, 1999, for any ultrasonic diathermy described in paragraph (b) of this section that was in commercial distribution before May 28, 1976, or that has, on or before July 13, 1999, been found to be substantially equivalent to an ultrasonic diathermy described in paragraph (b) of this section that was in commercial distribution before May 28, 1976. Any other ultrasonic diathermy described in paragraph (b) of this section shall have an approved PMA or declared completed PDP in effect before being placed in commercial distribution.

[48 FR 53047, Nov. 23, 1983, as amended at 52 FR 17742, May 11, 1987; 64 FR 18331, Apr. 14, 1999]

#### § 890.5350 Exercise component.

(a) *Identification*. An exercise component is a device that is used in conjunction with other forms of exercise and that is intended for medical purposes, such as to redevelop muscles or restore motion to joints or for use as an adjunct treatment for obesity. Examples include weights, dumbbells, straps, and adaptive hand mitts.

(b) *Classification*. Class I (general controls). The device is exempt from the premarket notification procedures in subpart E of part 807 of this chapter, subject to the limitations in § 890.9. The device is also exempt from the current good manufacturing practice requirements of the quality system regulation in part 820 of this chapter, with the exception of § 820.180, regarding general

## § 890.5360

requirements concerning records and § 820.198, regarding complaint files.

[48 FR 53047, Nov. 23, 1983, as amended at 66 FR 38818, July 25, 2001]

## § 890.5360 Measuring exercise equipment.

(a) *Identification.* Measuring exercise equipment consist of manual devices intended for medical purposes, such as to redevelop muscles or restore motion to joints or for use as an adjunct treatment for obesity. These devices also include instrumentation, such as the pulse rate monitor, that provide information used for physical evaluation and physical planning purposes., Examples include a therapeutic exercise bicycle with measuring instrumentation, a manually propelled treadmill with measuring instrumentation, and a rowing machine with measuring instrumentation.

(b) *Classification.* Class II (special controls). The device, when it is a measuring exerciser, is exempt from the premarket notification procedures in subpart E of part 807 of this chapter subject to the limitations in § 890.9.

[48 FR 53047, Nov. 23, 1983, as amended at 84 FR 71818, Dec. 30, 2020]

## § 890.5370 Nonmeasuring exercise equipment.

(a) *Identification.* Nonmeasuring exercise equipment consist of devices intended for medical purposes, such as to redevelop muscles or restore motion to joints or for use as an adjunct treatment for obesity. Examples include a prone scooter board, parallel bars, a mechanical treadmill, an exercise table, and a manually propelled exercise bicycle.

(b) *Classification.* Class I (general controls). The device is exempt from the premarket notification procedures in subpart E of part 807 of this chapter, subject to the limitations in § 890.9. The device is also exempt from the current good manufacturing practice requirements of the quality system regulation in part 820 of this chapter, with the exception of § 820.180, regarding general requirements concerning records and § 820.198, regarding complaint files.

[48 FR 53047, Nov. 23, 1983, as amended at 66 FR 38818, July 25, 2001]

## 21 CFR Ch. I (4–1–20 Edition)

## § 890.5380 Powered exercise equipment.

(a) *Identification.* Powered exercise equipment consist of powered devices intended for medical purposes, such as to redevelop muscles or restore motion to joints or for use as an adjunct treatment for obesity. Examples include a powered treadmill, a powered bicycle, and powered parallel bars.

(b) *Classification.* Class I (general controls). The device is exempt from the premarket notification procedures in subpart E of part 807 of this chapter, subject to the limitations in § 890.9.

[48 FR 53047, Nov. 23, 1983, as amended at 61 FR 1125, Jan. 16, 1996; 66 FR 38818, July 25, 2001]

## § 890.5410 Powered finger exerciser.

(a) *Identification.* A powered finger exerciser is a device intended for medical purposes to increase flexion and the extension range of motion of the joints of the second to the fifth fingers of the hand.

(b) *Classification.* Class I (general controls). The device is exempt from the premarket notification procedures in subpart E of part 807 of this chapter, subject to the limitations in § 890.9.

[48 FR 53047, Nov. 23, 1983, as amended at 61 FR 1125, Jan. 16, 1996; 66 FR 38818, July 25, 2001]

## § 890.5500 Infrared lamp.

(a) *Identification.* An infrared lamp is a device intended for medical purposes that emits energy at infrared frequencies (approximately 700 nanometers to 50,000 nanometers) to provide topical heating.

(b) *Classification.* Class II (special controls). The device, when it is an infrared therapeutic heating lamp, is exempt from the premarket notification procedures in subpart E of part 807 of this chapter subject to the limitations in § 890.9.

[48 FR 53047, Nov. 23, 1983, as amended at 84 FR 71818, Dec. 30, 2019]

## § 890.5525 Iontophoresis device.

(a) *Iontophoresis device intended for certain specified uses—(1) Identification.* An iontophoresis device is a device that is intended to use a direct current to introduce ions of soluble salts or



other drugs into the body and induce sweating for use in the diagnosis of cystic fibrosis or for other uses if the labeling of the drug intended for use with the device bears adequate directions for the device's use with that drug. When used in the diagnosis of cystic fibrosis, the sweat is collected and its composition and weight are determined.

(2) *Classification*. Class II (performance standards).

(b) *Iontophoresis device intended for any other purposes*—(1) *Identification*. An iontophoresis device intended for any other purposes is a prescription device that is intended to use a current to introduce ions of drugs or non-drug solutions into the body for medical purposes other than those specified in paragraph (a) of this section, meaning that the device is not intended for use in diagnosis of cystic fibrosis, or a specific drug is not specified in the labeling of the iontophoresis device.

(2) *Classification*. Class II (special controls). The device is classified as class II. The special controls for this device are:

(i) The following performance testing must be conducted:

(A) Testing using a drug approved for iontophoretic delivery, or a solution if identified in the labeling, to demonstrate safe use of the device as intended;

(B) Testing of the ability of the device to maintain a safe pH level; and

(C) If used in the ear, testing of the device to demonstrate mechanical safety.

(ii) Labeling must include adequate instructions for use, including sufficient information for the health care provider to determine the device characteristics that affect delivery of the drug or solution and to select appropriate drug or solution dosing information for administration by iontophoresis. This includes the following:

(A) A description and/or graphical representation of the electrical output;

(B) A description of the electrode materials and pH buffer;

(C) When intended for general drug delivery, language referring the user to drug labeling approved for iontophoretic delivery to determine if the drug they intend to deliver is spe-

cifically approved for use with that type of device and to obtain relevant dosing information; and

(D) A detailed summary of the device-related and procedure-related complications pertinent to use of the device, and appropriate warnings and contraindications, including the following warning:

*Warning*: Potential systemic adverse effects may result from use of this device. Drugs or solutions delivered with this device have the potential to reach the blood stream and cause systemic effects. Carefully read all labeling of the drug or solution used with this device to understand all potential adverse effects and to ensure appropriate dosing information. If systemic manifestations occur, refer to the drug or solution labeling for appropriate action.

(iii) Appropriate analysis/testing must demonstrate electromagnetic compatibility, electrical safety, thermal safety, and mechanical safety.

(iv) Appropriate software verification, validation, and hazard analysis must be performed.

(v) The elements of the device that may contact the patient must be demonstrated to be biocompatible.

(vi) The elements of the device that may contact the patient must be assessed for sterility, for devices labeled as sterile.

(vii) Performance data must support the shelf life of the elements of the device that may be affected by aging by demonstrating continued package integrity and device functionality over the stated shelf life.

[48 FR 53047, Nov. 23, 1983, as amended at 52 FR 17742, May 11, 1987; 81 FR 48706, July 26, 2016; 83 FR 13864, Apr. 2, 2018]

#### § 890.5575 Powered external limb overload warning device.

(a) *Identification*. A powered external limb overload warning device is a device intended for medical purposes to warn a patient of an overload or an underload in the amount of pressure placed on a leg.

(b) *Classification*. Class II (special controls). The device is exempt from the premarket notification procedures

## § 890.5650

in subpart E of part 807 of this chapter subject to the limitations in § 890.9.

[48 FR 53047, Nov. 23, 1983, as amended at 84 FR 71818, Dec. 30, 2019]

### § 890.5650 Powered inflatable tube massager.

(a) *Identification.* A powered inflatable tube massager is a powered device intended for medical purposes, such as to relieve minor muscle aches and pains and to increase circulation. It simulates kneading and stroking of tissues with the hands by use of an inflatable pressure cuff.

(b) *Classification.* Class II (performance standards).

### § 890.5660 Therapeutic massager.

(a) *Identification.* A therapeutic massager is an electrically powered device intended for medical purposes, such as to relieve minor muscle aches and pains.

(b) *Classification.* Class I (general controls). The device is exempt from the premarket notification procedures in subpart E of part 807 of this chapter, subject to the limitations in § 890.9.

[48 FR 53047, Nov. 23, 1983, as amended at 61 FR 1125, Jan. 16, 1996; 66 FR 38818, July 25, 2001]

### § 890.5670 Internal therapeutic massager.

(a) *Identification.* A hand-held internal therapeutic massager device is a prescription device intended for medical purposes to manually provide direct pressure applied to localized areas of pain or tenderness in the myofascial tissue associated with chronic pelvic pain syndromes. The device is inserted rectally or vaginally and provides quantitative feedback to the user of the applied force to the target tissue.

(b) *Classification.* Class II (special controls). The special controls for this device are:

(1) Labeling must include adequate directions for use.

(2) Non-clinical performance testing must demonstrate electromagnetic compatibility (EMC), electrical safety and mechanical safety.

(3) Non-clinical performance testing must demonstrate that the device performs as intended under anticipated conditions of use. The following per-

## 21 CFR Ch. I (4–1–20 Edition)

formance characteristics must be tested:

(i) Mechanical durability; and  
(ii) Accuracy of the feedback mechanism.

(4) Software verification, validation, and hazard analysis must be performed.

(5) The patient-contacting components of the device must be demonstrated to be biocompatible.

[84 FR 57323, Oct. 25, 2019]

### § 890.5700 Cold pack.

(a) *Identification.* A cold pack is a device intended for medical purposes that consists of a compact fabric envelope containing a specially hydrated pliable silicate gel capable of forming to the contour of the body and that provides cold therapy for body surfaces.

(b) *Classification.* Class I (general controls). The device is exempt from the premarket notification procedures in subpart E of part 807. The device also is exempt from the current good manufacturing practice requirements of the quality system regulation in part 820, with the exception of § 820.180, with respect to general requirements concerning records, and § 820.198, with respect to complaint files.

### § 890.5710 Hot or cold disposable pack.

(a) *Identification.* A hot or cold disposable pack is a device intended for medical purposes that consists of a sealed plastic bag incorporating chemicals that, upon activation, provides hot or cold therapy for body surfaces.

(b) *Classification.* Class I (general controls). Except when intended for use on infants, the device is exempt from the premarket notification procedures in subpart E of part 807 of this chapter subject to § 890.9.

[48 FR 53047, Nov. 23, 1983, as amended at 65 FR 2322, Jan. 14, 2000]

### § 890.5720 Water circulating hot or cold pack.

(a) *Identification.* A water circulating hot or cold pack is a device intended for medical purposes that operates by pumping heated or chilled water through a plastic bag and that provides hot or cold therapy for body surfaces.

(b) *Classification.* Class II (special controls). The device is exempt from

the premarket notification procedures in subpart E of part 807 of this chapter subject to § 890.9.

[48 FR 53047, Nov. 23, 1983, as amended at 63 FR 59231, Nov. 3, 1998]

**§ 890.5730 Moist heat pack.**

(a) *Identification.* A moist heat pack is a device intended for medical purposes that consists of silica gel in a fabric container used to retain an elevated temperature and that provides moist heat therapy for body surfaces.

(b) *Classification.* Class I (general controls). The device is exempt from the premarket notification procedures in subpart E of part 807 of this chapter, subject to the limitations in § 890.9. The device is also exempt from the current good manufacturing practice requirements of the quality system regulation in part 820 of this chapter, with the exception of § 820.180, regarding general requirements concerning records and § 820.198, regarding complaint files.

[48 FR 53047, Nov. 23, 1983, as amended at 66 FR 38818, July 25, 2001]

**§ 890.5740 Powered heating pad.**

(a) *Identification.* A powered heating pad is an electrical device intended for medical purposes that provides dry heat therapy for body surfaces. It is capable of maintaining an elevated temperature during use.

(b) *Classification.* Class II (special controls). The device is exempt from the premarket notification procedures in subpart E part 807 of this chapter subject to § 890.9.

[48 FR 53047, Nov. 23, 1983, as amended at 63 FR 59231, Nov. 3, 1998]

**§ 890.5760 Nonpowered lower extremity pressure wrap.**

(a) *Identification.* A nonpowered lower extremity pressure wrap is a prescription device that applies mechanical pressure by wrapping around the lower extremity, such as the leg or foot, and is intended for primary Restless Leg Syndrome.

(b) *Classification.* Class I (general controls). The device is exempt from the premarket notification procedures in subpart E of part 807 of this chapter, subject to the limitations in § 890.9.

[79 FR 37950, July 3, 2014]

**§ 890.5765 Pressure-applying device.**

(a) *Identification.* A pressure-applying device is a device intended for medical purposes to apply continuous pressure to the paravertebral tissues for muscular relaxation and neuro-inhibition. It consists of a table with an adjustable overhead weight that, in place of the therapist's hands, presses on the back of a prone patient.

(b) *Classification.* Class I (general controls). The device is exempt from the premarket notification procedures in subpart E of part 807 of this chapter, subject to the limitations in § 890.9.

[48 FR 53047, Nov. 23, 1983, as amended at 59 FR 63015, Dec. 7, 1994; 66 FR 38818, July 25, 2001]

**§ 890.5850 Powered muscle stimulator.**

(a) *Identification.* A powered muscle stimulator is an electrically powered device intended for medical purposes that repeatedly contracts muscles by passing electrical currents through electrodes contacting the affected body area.

(b) *Classification.* Class II (performance standards).

**§ 890.5860 Ultrasound and muscle stimulator.**

(a) *Ultrasound and muscle stimulator for use in applying therapeutic deep heat for selected medical conditions—(1) Identification.* An ultrasound and muscle stimulator for use in applying therapeutic deep heat for selected medical conditions is a device that applies to specific areas of the body ultrasonic energy at a frequency beyond 20 kilohertz and that is intended to generate deep heat within body tissues for the treatment of selected medical conditions such as relief of pain, muscle spasms, and joint contractures, but not for the treatment of malignancies. The device also passes electrical currents through the body area to stimulate or relax muscles.

(2) *Classification.* Class II (performance standards).

(b) *Ultrasound and muscle stimulator for all other uses—(1) Identification.* An ultrasound and muscle stimulator for all other uses except for the treatment of malignancies is a device that applies

**§ 890.5880**

to the body ultrasonic energy at a frequency beyond 20 kilohertz and applies to the body electrical currents and that is intended for the treatment of medical conditions by means other than the generation of deep heat within body tissues and the stimulation or relaxation of muscles as described in paragraph (a) of this section.

(2) *Classification*. Class III (premarket approval).

(c) *Date PMA or notice of completion of PDP is required*. A PMA or notice of completion of a PDP for a device described in paragraph (b) of this section is required to be filed with the Food and Drug Administration on or before July 13, 1999 for any ultrasound and muscle stimulator described in paragraph (b) of this section that was in commercial distribution before May 28, 1976, or that has, on or before July 13, 1999, been found to be substantially equivalent to an ultrasound and muscle stimulator described in paragraph (b) of this section that was in commercial distribution before May 28, 1976. Any other ultrasound and muscle stimulator described in paragraph (b) of this section shall have an approved PMA or declared completed PDP in effect before being placed in commercial distribution.

[48 FR 53047, Nov. 23, 1983, as amended at 52 FR 17742, May 11, 1987; 64 FR 18331, Apr. 14, 1999]

**§ 890.5880 Multi-function physical therapy table.**

(a) *Identification*. A multi-function physical therapy table is a device intended for medical purposes that consists of a motorized table equipped to provide patients with heat, traction, and muscle relaxation therapy.

(b) *Classification*. Class II (performance standards).

**§ 890.5900 Power traction equipment.**

(a) *Identification*. Powered traction equipment consists of powered devices intended for medical purposes for use in conjunction with traction accessories, such as belts and harnesses, to exert therapeutic pulling forces on the patient's body.

(b) *Classification*. Class II (performance standards).

**21 CFR Ch. I (4-1-20 Edition)**

**§ 890.5925 Traction accessory.**

(a) *Identification*. A traction accessory is a nonpowered accessory device intended for medical purposes to be used with powered traction equipment to aid in exerting therapeutic pulling forces on the patient's body. This generic type of device includes the pulley, strap, head halter, and pelvic belt.

(b) *Classification*. Class I (general controls). The device is exempt from the premarket notification procedures in subpart E of part 807 of this chapter, subject to the limitations in § 890.9. The device is also exempt from the current good manufacturing practice requirements of the quality system regulation in part 820 of this chapter, with the exception of § 820.180, regarding general requirements concerning records and § 820.198, regarding complaint files.

[48 FR 53047, Nov. 23, 1983, as amended at 61 FR 1125, Jan. 16, 1996; 66 FR 38818, July 25, 2001]

**§ 890.5940 Chilling unit.**

(a) *Identification*. A chilling unit is a refrigerative device intended for medical purposes to chill and maintain cold packs at a reduced temperature.

(b) *Classification*. Class I (general controls). The device is exempt from the premarket notification procedures in subpart E of part 807 of this chapter, subject to the limitations in § 890.9

[48 FR 53047, Nov. 23, 1983, as amended at 61 FR 1125, Jan. 16, 1996; 66 FR 38818, July 25, 2001]

**§ 890.5950 Powered heating unit.**

(a) *Identification*. A powered heating unit is a device intended for medical purposes that consists of an encased cabinet containing hot water and that is intended to heat and maintain hot packs at an elevated temperature.

(b) *Classification*. Class I (general controls). The device is exempt from the premarket notification procedures in subpart E of part 807 of this chapter, subject to the limitations in § 890.9.

[48 FR 53047, Nov. 23, 1983, as amended at 61 FR 1125, Jan. 16, 1996; 66 FR 38818, July 25, 2001]

**§ 890.5975 Therapeutic vibrator.**

(a) *Identification.* A therapeutic vibrator is an electrically powered device intended for medical purposes that incorporates various kinds of pads and that is held in the hand or attached to the hand or to a table. It is intended for various uses, such as relaxing muscles and relieving minor aches and pains.

(b) *Classification.* Class I (general controls). The device is exempt from the premarket notification procedures in subpart E of part 807 of this chapter, subject to the limitations in § 890.9.

[48 FR 53047, Nov. 23, 1983, as amended at 61 FR 1125, Jan. 16, 1996; 66 FR 38818, July 25, 2001]

**PART 892—RADIOLOGY DEVICES****Subpart A—General Provisions**

## Sec.

- 892.1 Scope.
- 892.3 Effective dates of requirement for premarket approval.
- 892.9 Limitations of exemptions from section 510(k) of the Federal Food, Drug, and Cosmetic Act (the act).

**Subpart B—Diagnostic Devices**

- 892.1000 Magnetic resonance diagnostic device.
- 892.1100 Scintillation (gamma) camera.
- 892.1110 Positron camera.
- 892.1130 Nuclear whole body counter.
- 892.1170 Bone densitometer.
- 892.1180 Bone sonometer.
- 892.1200 Emission computed tomography system.
- 892.1220 Fluorescent scanner.
- 892.1300 Nuclear rectilinear scanner.
- 892.1310 Nuclear tomography system.
- 892.1320 Nuclear uptake probe.
- 892.1330 Nuclear whole body scanner.
- 892.1350 Nuclear scanning bed.
- 892.1360 Radionuclide dose calibrator.
- 892.1370 Nuclear anthropomorphic phantom.
- 892.1380 Nuclear flood source phantom.
- 892.1390 Radionuclide rebreathing system.
- 892.1400 Nuclear sealed calibration source.
- 892.1410 Nuclear electrocardiograph synchronizer.
- 892.1420 Radionuclide test pattern phantom.
- 892.1540 Nonfetal ultrasonic monitor.
- 892.1550 Ultrasonic pulsed doppler imaging system.
- 892.1560 Ultrasonic pulsed echo imaging system.
- 892.1570 Diagnostic ultrasonic transducer.
- 892.1600 Angiographic x-ray system.
- 892.1610 Diagnostic x-ray beam-limiting device.

- 892.1620 Cine or spot fluorographic x-ray camera.
- 892.1630 Electrostatic x-ray imaging system.
- 892.1640 Radiographic film marking system.
- 892.1650 Image-intensified fluoroscopic x-ray system.
- 892.1660 Non-image-intensified fluoroscopic x-ray system.
- 892.1670 Spot-film device.
- 892.1680 Stationary x-ray system.
- 892.1700 Diagnostic x-ray high voltage generator.
- 892.1710 Mammographic x-ray system.
- 892.1715 Full-field digital mammography system.
- 892.1720 Mobile x-ray system.
- 892.1730 Photofluorographic x-ray system.
- 892.1740 Tomographic x-ray system.
- 892.1750 Computed tomography x-ray system.
- 892.1760 Diagnostic x-ray tube housing assembly.
- 892.1770 Diagnostic x-ray tube mount.
- 892.1820 Pneumoencephalographic chair.
- 892.1830 Radiologic patient cradle.
- 892.1840 Radiographic film.
- 892.1850 Radiographic film cassette.
- 892.1860 Radiographic film/cassette changer.
- 892.1870 Radiographic film/cassette changer programmer.
- 892.1880 Wall-mounted radiographic cassette holder.
- 892.1890 Radiographic film illuminator.
- 892.1900 Automatic radiographic film processor.
- 892.1910 Radiographic grid.
- 892.1920 Radiographic head holder.
- 892.1940 Radiologic quality assurance instrument.
- 892.1950 Radiographic anthropomorphic phantom.
- 892.1960 Radiographic intensifying screen.
- 892.1970 Radiographic ECG/respirator synchronizer.
- 892.1980 Radiologic table.
- 892.1990 Transilluminator for breast evaluation.
- 892.2010 Medical image storage device.
- 892.2020 Medical image communications device.
- 892.2030 Medical image digitizer.
- 892.2040 Medical image hardcopy device.
- 892.2050 Picture archiving and communications system.
- 892.2060 Radiological computer-assisted diagnostic software for lesions suspicious of cancer.
- 892.2070 Medical image analyzer.
- 892.2080 Radiological computer aided triage and notification software.

**Subparts C–E [Reserved]****Subpart F—Therapeutic Devices**

- 892.5050 Medical charged-particle radiation therapy system.

## § 892.1

- 892.5300 Medical neutron radiation therapy system.
- 892.5650 Manual radionuclide applicator system.
- 892.5700 Remote controlled radionuclide applicator system.
- 892.5710 Radiation therapy beam-shaping block.
- 892.5720 Rectal balloon for prostate immobilization.
- 892.5725 Absorbable perirectal spacer.
- 892.5730 Radionuclide brachytherapy source.
- 892.5740 Radionuclide teletherapy source.
- 892.5750 Radionuclide radiation therapy system.
- 892.5770 Powered radiation therapy patient support assembly.
- 892.5780 Light beam patient position indicator.
- 892.5840 Radiation therapy simulation system.
- 892.5900 X-ray radiation therapy system.
- 892.5930 Therapeutic x-ray tube housing assembly.

### Subpart G—Miscellaneous Devices

- 892.6500 Personnel protective shield.

AUTHORITY: 21 U.S.C. 351, 360, 360c, 360e, 360j, 360l, 371.

SOURCE: 53 FR 1567, Jan. 20, 1988, unless otherwise noted.

EDITORIAL NOTE: Nomenclature changes to part 892 appear at 73 FR 35341, June 23, 2008.

### Subpart A—General Provisions

#### § 892.1 Scope.

(a) This part sets forth the classification of radiology devices intended for human use that are in commercial distribution.

(b) The identification of a device in a regulation in this part is not a precise description of every device that is, or will be, subject to the regulation. A manufacturer who submits a premarket notification submission for a device under part 807 cannot show merely that the device is accurately described by the section title and identification provision of a regulation in this part but shall state why the device is substantially equivalent to other devices, as required by § 807.87.

(c) To avoid duplicative listings, a radiology device that has two or more types of uses (e.g., use both as a diagnostic device and a therapeutic device) is listed in one subpart only.

(d) References in this part to regulatory sections of the Code of Federal

## 21 CFR Ch. I (4–1–20 Edition)

Regulations are to chapter I of this title 21, unless otherwise noted.

(e) Guidance documents referenced in this part are available on the Internet at <http://www.fda.gov/MedicalDevices/DeviceRegulationandGuidance/GuidanceDocuments/default.htm>.

[53 FR 1567, Jan. 20, 1988, as amended at 73 FR 40969, July 17, 2008; 78 FR 18233, Mar. 26, 2013]

#### § 892.3 Effective dates of requirement for premarket approval.

A device included in this part that is classified into class III (premarket approval) shall not be commercially distributed after the date shown in the regulation classifying the device unless the manufacturer has an approval under section 515 of the act (unless an exemption has been granted under section 520(g)(2) of the act). An approval under section 515 of the act consists of FDA's issuance of an order approving an application for premarket approval (PMA) for the device or declaring completed a product development protocol (PDP) for the device.

(a) Before FDA requires that a device commercially distributed before the enactment date of the amendments, or a device that has been found substantially equivalent to such a device, has an approval under section 515 of the act, FDA must promulgate a regulation under section 515(b) of the act requiring such approval, except as provided in paragraph (b) of this section. Such a regulation under section 515(b) of the act shall not be effective during the grace period ending on the 90th day after its promulgation or on the last day of the 30th full calendar month after the regulation that classifies the device into class III is effective, whichever is later. See section 501(f)(2)(B) of the act. Accordingly, unless an effective date of the requirement for premarket approval is shown in the regulation for a device classified into class III in this part, the device may be commercially distributed without FDA's issuance of an order approving a PMA or declaring completed a PDP for the device. If FDA promulgates a regulation under section 515(b) of the act requiring premarket approval for a device, section 501(f)(1)(A) of the act applies to the device.

(b) Any new, not substantially equivalent, device introduced into commercial distribution on or after May 28, 1976, including a device formerly marketed that has been substantially altered, is classified by statute (section 513(f) of the act) into class III without any grace period and FDA must have issued an order approving a PMA or declaring completed a PDP for the device before the device is commercially distributed unless it is reclassified. If FDA knows that a device being commercially distributed may be a "new" device as defined in this section because of any new intended use or other reasons, FDA may codify the statutory classification of the device into class III for such new use. Accordingly, the regulation for such a class III device states that as of the enactment date of the amendments, May 28, 1976, the device must have an approval under section 515 of the act before commercial distribution.

**§ 892.9 Limitations of exemptions from section 510(k) of the Federal Food, Drug, and Cosmetic Act (the act).**

The exemption from the requirement of premarket notification (section 510(k) of the act) for a generic type of class I or II device is only to the extent that the device has existing or reasonably foreseeable characteristics of commercially distributed devices within that generic type or, in the case of in vitro diagnostic devices, only to the extent that misdiagnosis as a result of using the device would not be associated with high morbidity or mortality. Accordingly, manufacturers of any commercially distributed class I or II device for which FDA has granted an exemption from the requirement of premarket notification must still submit a premarket notification to FDA before introducing or delivering for introduction into interstate commerce for commercial distribution the device when:

(a) The device is intended for a use different from the intended use of a legally marketed device in that generic type of device; e.g., the device is intended for a different medical purpose, or the device is intended for lay use where the former intended use was by health care professionals only;

(b) The modified device operates using a different fundamental scientific technology than a legally marketed device in that generic type of device; e.g., a surgical instrument cuts tissue with a laser beam rather than with a sharpened metal blade, or an in vitro diagnostic device detects or identifies infectious agents by using deoxyribonucleic acid (DNA) probe or nucleic acid hybridization technology rather than culture or immunoassay technology; or

(c) The device is an in vitro device that is intended:

(1) For use in the diagnosis, monitoring, or screening of neoplastic diseases with the exception of immunohistochemical devices;

(2) For use in screening or diagnosis of familial or acquired genetic disorders, including inborn errors of metabolism;

(3) For measuring an analyte that serves as a surrogate marker for screening, diagnosis, or monitoring life-threatening diseases such as acquired immune deficiency syndrome (AIDS), chronic or active hepatitis, tuberculosis, or myocardial infarction or to monitor therapy;

(4) For assessing the risk of cardiovascular diseases;

(5) For use in diabetes management;

(6) For identifying or inferring the identity of a microorganism directly from clinical material;

(7) For detection of antibodies to microorganisms other than immunoglobulin G (IgG) or IgG assays when the results are not qualitative, or are used to determine immunity, or the assay is intended for use in matrices other than serum or plasma;

(8) For noninvasive testing as defined in § 812.3(k) of this chapter; and

(9) For near patient testing (point of care).

[65 FR 2322, Jan. 14, 2000]

**Subpart B—Diagnostic Devices**

**§ 892.1000 Magnetic resonance diagnostic device.**

(a) *Identification.* A magnetic resonance diagnostic device is intended for general diagnostic use to present images which reflect the spatial distribution and/or magnetic resonance spectra

**§ 892.1100**

**21 CFR Ch. I (4–1–20 Edition)**

which reflect frequency and distribution of nuclei exhibiting nuclear magnetic resonance. Other physical parameters derived from the images and/or spectra may also be produced. The device includes hydrogen-1 (proton) imaging, sodium-23 imaging, hydrogen-1 spectroscopy, phosphorus-31 spectroscopy, and chemical shift imaging (preserving simultaneous frequency and spatial information).

(b) *Classification.* Class II (special controls). A magnetic resonance imaging disposable kit intended for use with a magnetic resonance diagnostic device only is exempt from the premarket notification procedures in subpart E of part 807 of this chapter subject to the limitations in § 892.9.

[53 FR 5078, Feb. 1, 1989, as amended at 84 FR 71818, Dec. 30, 2019]

**§ 892.1100 Scintillation (gamma) camera.**

(a) *Identification.* A scintillation (gamma) camera is a device intended to image the distribution of radionuclides in the body by means of a photon radiation detector. This generic type of device may include signal analysis and display equipment, patient and equipment supports, radionuclide anatomical markers, component parts, and accessories.

(b) *Classification.* Class I (general controls).

[55 FR 48443, Nov. 20, 1990, as amended at 66 FR 46953, Sept. 10, 2001]

**§ 892.1110 Positron camera.**

(a) *Identification.* A positron camera is a device intended to image the distribution of positron-emitting radionuclides in the body. This generic type of device may include signal analysis and display equipment, patient and equipment supports, radionuclide anatomical markers, component parts, and accessories.

(b) *Classification.* Class I (general controls).

[55 FR 48444, Nov. 20, 1990, as amended at 66 FR 46953, Sept. 10, 2001]

**§ 892.1130 Nuclear whole body counter.**

(a) *Identification.* A nuclear whole body counter is a device intended to

measure the amount of radionuclides in the entire body. This generic type of device may include signal analysis and display equipment, patient and equipment supports, component parts, and accessories.

(b) *Classification.* Class I (general controls). The device is exempt from the premarket notification procedures in subpart E of part 807 of this chapter, subject to the limitations in § 892.9.

[53 FR 1567, Jan. 20, 1988, as amended at 59 FR 63015, Dec. 7, 1994; 66 FR 38818, July 25, 2001]

[55 FR 48444, Nov. 20, 1990]

**§ 892.1170 Bone densitometer.**

(a) *Identification.* A bone densitometer is a device intended for medical purposes to measure bone density and mineral content by x-ray or gamma ray transmission measurements through the bone and adjacent tissues. This generic type of device may include signal analysis and display equipment, patient and equipment supports, component parts, and accessories.

(b) *Classification.* Class II.

**§ 892.1180 Bone sonometer.**

(a) *Identification.* A bone sonometer is a device that transmits ultrasound energy into the human body to measure acoustic properties of bone that indicate overall bone health and fracture risk. The primary components of the device are a voltage generator, a transmitting transducer, a receiving transducer, and hardware and software for reception and processing of the received ultrasonic signal.

(b) *Classification.* Class II (special controls). The special control for this device is FDA's "Guidance for Industry and FDA Staff; Class II Special Controls Guidance Document: Bone Sonometers." See § 892.1(e) for the availability of this guidance document.

[73 FR 40969, July 17, 2008]

**§ 892.1200 Emission computed tomography system.**

(a) *Identification.* An emission computed tomography system is a device intended to detect the location and distribution of gamma ray- and positron-emitting radionuclides in the body and produce cross-sectional images through



computer reconstruction of the data. This generic type of device may include signal analysis and display equipment, patient and equipment supports, radionuclide anatomical markers, component parts, and accessories.

(b) *Classification*. Class II.

**§ 892.1220 Fluorescent scanner.**

(a) *Identification*. A fluorescent scanner is a device intended to measure the induced fluorescent radiation in the body by exposing the body to certain x-rays or low-energy gamma rays. This generic type of device may include signal analysis and display equipment, patient and equipment supports, component parts and accessories.

(b) *Classification*. Class II.

**§ 892.1300 Nuclear rectilinear scanner.**

(a) *Identification*. A nuclear rectilinear scanner is a device intended to image the distribution of radionuclides in the body by means of a detector (or detectors) whose position moves in two directions with respect to the patient. This generic type of device may include signal analysis and display equipment, patient and equipment supports, radionuclide anatomical markers, component parts, and accessories.

(b) *Classification*. Class I (general controls). The device is exempt from the premarket notification procedures in subpart E of part 807 of this chapter, subject to the limitations in § 892.9.

[55 FR 48444, Nov. 20, 1990, as amended at 65 FR 2322, Jan. 14, 2000; 66 FR 38818, July 25, 2001]

**§ 892.1310 Nuclear tomography system.**

(a) *Identification*. A nuclear tomography system is a device intended to detect nuclear radiation in the body and produce images of a specific cross-sectional plane of the body by blurring or eliminating detail from other planes. This generic type of devices may include signal analysis and display equipment, patient and equipment supports, radionuclide anatomical markers, component parts, and accessories.

(b) *Classification*. Class II.

**§ 892.1320 Nuclear uptake probe.**

(a) *Identification*. A nuclear uptake probe is a device intended to measure

the amount of radionuclide taken up by a particular organ or body region. This generic type of device may include a single or multiple detector probe, signal analysis and display equipment, patient and equipment supports, component parts, and accessories.

(b) *Classification*. Class I (general controls). The device is exempt from the premarket notification procedures in subpart E of part 807 of this chapter subject to § 892.9.

[55 FR 48444, Nov. 20, 1990, as amended at 65 FR 2322, Jan. 14, 2000]

**§ 892.1330 Nuclear whole body scanner.**

(a) *Identification*. A nuclear whole body scanner is a device intended to measure and image the distribution of radionuclides in the body by means of a wide-aperture detector whose position moves in one direction with respect to the patient. This generic type of device may include signal analysis and display equipment, patient and equipment supports, radionuclide anatomical markers, component parts, and accessories.

(b) *Classification*. Class I (general controls). The device is exempt from the premarket notification procedures in subpart E of part 807 of this chapter subject to § 892.9.

[55 FR 48444, Nov. 20, 1990, as amended at 65 FR 2322, Jan. 14, 2000]

**§ 892.1350 Nuclear scanning bed.**

(a) *Identification*. A nuclear scanning bed is an adjustable bed intended to support a patient during a nuclear medicine procedure.

(b) *Classification*. Class I (general controls). The device is exempt from the premarket notification procedures in subpart E of part 807 of this chapter subject to § 892.9.

[55 FR 48444, Nov. 20, 1990, as amended at 59 FR 63015, Dec. 7, 1994; 65 FR 2322, Jan. 14, 2000]

**§ 892.1360 Radionuclide dose calibrator.**

(a) *Identification*. A radionuclide dose calibrator is a radiation detection device intended to assay radionuclides before their administration to patients.

**§ 892.1370**

(b) *Classification*. Class II.

**§ 892.1370 Nuclear anthropomorphic phantom.**

(a) *Identification*. A nuclear anthropomorphic phantom is a human tissue facsimile that contains a radioactive source or a cavity in which a radioactive sample can be inserted. It is intended to calibrate nuclear uptake probes or other medical instruments.

(b) *Classification*. Class I (general controls). The device is exempt from the premarket notification procedures in subpart E of part 807 of this chapter, subject to the limitations in § 892.9.

[53 FR 1567, Jan. 20, 1988, as amended at 54 FR 13832, Apr. 5, 1989; 66 FR 38818, July 25, 2001]

**§ 892.1380 Nuclear flood source phantom.**

(a) *Identification*. A nuclear flood source phantom is a device that consists of a radiolucent container filled with a uniformly distributed solution of a desired radionuclide. It is intended to calibrate a medical gamma camera-collimator system for uniformity of response.

(b) *Classification*. Class I (general controls). The device is exempt from the premarket notification procedures in subpart E of part 807 of this chapter, subject to the limitations in § 892.9.

[53 FR 1567, Jan. 20, 1988, as amended at 54 FR 13832, Apr. 5, 1989; 66 FR 38819, July 25, 2001]

**§ 892.1390 Radionuclide rebreathing system.**

(a) *Identification*. A radionuclide rebreathing system is a device intended to be used to contain a gaseous or volatile radionuclide or a radionuclide-labeled aerosol and permit it to be respired by the patient during nuclear medicine ventilatory tests (testing process of exchange between the lungs and the atmosphere). This generic type of device may include signal analysis and display equipment, patient and equipment supports, component parts, and accessories.

(b) *Classification*. Class II.

**21 CFR Ch. I (4–1–20 Edition)**

**§ 892.1400 Nuclear sealed calibration source.**

(a) *Identification*. A nuclear sealed calibration source is a device that consists of an encapsulated reference radionuclide intended for calibration of medical nuclear radiation detectors.

(b) *Classification*. Class I (general controls). The device is exempt from the premarket notification procedures in subpart E of part 807 of this chapter, subject to the limitations in § 892.9.

[53 FR 1567, Jan. 20, 1988, as amended at 54 FR 13832, Apr. 5, 1989; 66 FR 38819, July 25, 2001]

**§ 892.1410 Nuclear electrocardiograph synchronizer.**

(a) *Identification*. A nuclear electrocardiograph synchronizer is a device intended for use in nuclear radiology to relate the time of image formation to the cardiac cycle during the production of dynamic cardiac images.

(b) *Classification*. Class I (general controls). The device is exempt from the premarket notification procedures in subpart E of part 807 of this chapter subject to § 892.9.

[55 FR 4844, Nov. 20, 1990, as amended at 65 FR 2322, Jan. 14, 2000]

**§ 892.1420 Radionuclide test pattern phantom.**

(a) *Identification*. A radionuclide test pattern phantom is a device that consists of an arrangement of radiopaque or radioactive material sealed in a solid pattern intended to serve as a test for a performance characteristic of a nuclear medicine imaging device.

(b) *Classification*. Class I (general controls). The device is exempt from the premarket notification procedures in subpart E of part 807 of this chapter, subject to the limitations in § 892.9.

[53 FR 1567, Jan. 20, 1988, as amended at 54 FR 13832, Apr. 5, 1989; 66 FR 38819, July 25, 2001]

**§ 892.1540 Nonfetal ultrasonic monitor.**

(a) *Identification*. A nonfetal ultrasonic monitor is a device that projects a continuous high-frequency sound wave into body tissue other than a fetus to determine frequency changes (doppler shift) in the reflected wave

## Food and Drug Administration, HHS

## § 892.1630

and is intended for use in the investigation of nonfetal blood flow and other nonfetal body tissues in motion. This generic type of device may include signal analysis and display equipment, patient and equipment supports, component parts, and accessories.

(b) *Classification*. Class II.

### § 892.1550 Ultrasonic pulsed doppler imaging system.

(a) *Identification*. An ultrasonic pulsed doppler imaging system is a device that combines the features of continuous wave doppler-effect technology with pulsed-echo effect technology and is intended to determine stationary body tissue characteristics, such as depth or location of tissue interfaces or dynamic tissue characteristics such as velocity of blood or tissue motion. This generic type of device may include signal analysis and display equipment, patient and equipment supports, component parts, and accessories.

(b) *Classification*. Class II.

### § 892.1560 Ultrasonic pulsed echo imaging system.

(a) *Identification*. An ultrasonic pulsed echo imaging system is a device intended to project a pulsed sound beam into body tissue to determine the depth or location of the tissue interfaces and to measure the duration of an acoustic pulse from the transmitter to the tissue interface and back to the receiver. This generic type of device may include signal analysis and display equipment, patient and equipment supports, component parts, and accessories.

(b) *Classification*. Class II (special controls). A biopsy needle guide kit intended for use with an ultrasonic pulsed echo imaging system only is exempt from the premarket notification procedures in subpart E of part 807 of this chapter subject to the limitations in § 892.9.

[48 FR 53047, Nov. 23, 1983, as amended at 84 FR 71818, Dec. 30, 2019]

### § 892.1570 Diagnostic ultrasonic transducer.

(a) *Identification*. A diagnostic ultrasonic transducer is a device made of a piezoelectric material that converts electrical signals into acoustic signals

and acoustic signals into electrical signals and intended for use in diagnostic ultrasonic medical devices. Accessories of this generic type of device may include transmission media for acoustically coupling the transducer to the body surface, such as acoustic gel, paste, or a flexible fluid container.

(b) *Classification*. Class II.

### § 892.1600 Angiographic x-ray system.

(a) *Identification*. An angiographic x-ray system is a device intended for radiologic visualization of the heart, blood vessels, or lymphatic system during or after injection of a contrast medium. This generic type of device may include signal analysis and display equipment, patient and equipment supports, component parts, and accessories.

(b) *Classification*. Class II.

### § 892.1610 Diagnostic x-ray beam-limiting device.

(a) *Identification*. A diagnostic x-ray beam-limiting device is a device such as a collimator, a cone, or an aperture intended to restrict the dimensions of a diagnostic x-ray field by limiting the size of the primary x-ray beam.

(b) *Classification*. Class II (special controls). The device is exempt from the premarket notification procedures in subpart E of part 807 of this chapter subject to the limitations in § 892.9.

[48 FR 53047, Nov. 23, 1983, as amended at 84 FR 71818, Dec. 30, 2019]

### § 892.1620 Cine or spot fluorographic x-ray camera.

(a) *Identification*. A cine or spot fluorographic x-ray camera is a device intended to photograph diagnostic images produced by x-rays with an image intensifier.

(b) *Classification*. Class II.

### § 892.1630 Electrostatic x-ray imaging system.

(a) *Identification*. An electrostatic x-ray imaging system is a device intended for medical purposes that uses an electrostatic field across a semiconductive plate, a gas-filled chamber, or other similar device to convert a pattern of x-radiation into an electrostatic image and, subsequently, into a visible image. This generic type

## § 892.1640

of device may include signal analysis and display equipment, patient and equipment supports, component parts, and accessories.

(b) *Classification.* Class II.

### § 892.1640 Radiographic film marking system.

(a) *Identification.* A radiographic film marking system is a device intended for medical purposes to add identification and other information onto radiographic film by means of exposure to visible light.

(b) *Classification.* Class I (general controls). The device is exempt from the premarket notification procedures in subpart E of part 807 of this chapter, subject to the limitations in § 892.9.

[55 FR 48444, Nov. 20, 1990, as amended at 59 FR 63015, Dec. 7, 1994; 66 FR 38819, July 25, 2001]

### § 892.1650 Image-intensified fluoroscopic x-ray system.

(a) *Identification.* An image-intensified fluoroscopic x-ray system is a device intended to visualize anatomical structures by converting a pattern of x-radiation into a visible image through electronic amplification. This generic type of device may include signal analysis and display equipment, patient and equipment supports, component parts, and accessories.

(b) *Classification.* Class II (special controls). An anthrogram tray or radiology dental tray intended for use with an image-intensified fluoroscopic x-ray system only is exempt from the premarket notification procedures in subpart E of part 807 of this chapter subject to the limitations in § 892.9. In addition, when intended as an accessory to the device described in paragraph (a) of this section, the fluoroscopic compression device is exempt from the premarket notification procedures in subpart E of part 807 of this chapter subject to the limitations in § 892.9.

[53 FR 1567, Jan. 20, 1988, as amended at 66 FR 57369, Nov. 15, 2001; 84 FR 71818, Dec. 30, 2019]

### § 892.1660 Non-image-intensified fluoroscopic x-ray system.

(a) *Identification.* A non-image-intensified fluoroscopic x-ray system is a device intended to be used to visualize

## 21 CFR Ch. I (4–1–20 Edition)

anatomical structures by using a fluorescent screen to convert a pattern of x-radiation into a visible image. This generic type of device may include signal analysis and display equipment, patient and equipment supports, component parts, and accessories.

(b) *Classification.* Class II.

### § 892.1670 Spot-film device.

(a) *Identification.* A spot-film device is an electromechanical component of a fluoroscopic x-ray system that is intended to be used for medical purposes to position a radiographic film cassette to obtain radiographs during fluoroscopy.

(b) *Classification.* Class II (special controls). The device is exempt from the premarket notification procedures in subpart E of part 807 of this chapter subject to the limitations in § 892.9.

[48 FR 53047, Nov. 23, 1983, as amended at 84 FR 71818, Dec. 30, 2019]

### § 892.1680 Stationary x-ray system.

(a) *Identification.* A stationary x-ray system is a permanently installed diagnostic system intended to generate and control x-rays for examination of various anatomical regions. This generic type of device may include signal analysis and display equipment, patient and equipment supports, component parts, and accessories.

(b) *Classification.* Class II (special controls). A radiographic contrast tray or radiology diagnostic kit intended for use with a stationary x-ray system only is exempt from the premarket notification procedures in subpart E of part 807 of this chapter subject to the limitations in § 892.9.

[48 FR 53047, Nov. 23, 1983, as amended at 84 FR 71818, Dec. 30, 2019]

### § 892.1700 Diagnostic x-ray high voltage generator.

(a) *Identification.* A diagnostic x-ray high voltage generator is a device that is intended to supply and control the electrical energy applied to a diagnostic x-ray tube for medical purposes. This generic type of device may include a converter that changes alternating current to direct current, filament transformers for the x-ray tube,

**Food and Drug Administration, HHS**

**§ 892.1760**

high voltage switches, electrical protective devices, or other appropriate elements.

(b) *Classification.* Class I (general controls). The device is exempt from the premarket notification procedures in subpart E of part 807 of this chapter, subject to the limitations in § 892.9.

[53 FR 1567, Jan. 20, 1988, as amended at 61 FR 1125, Jan. 16, 1996; 66 FR 38819, July 25, 2001]

**§ 892.1710 Mammographic x-ray system.**

(a) *Identification.* A mammographic x-ray system is a device intended to be used to produce radiographs of the breast. This generic type of device may include signal analysis and display equipment, patient and equipment supports, component parts, and accessories.

(b) *Classification.* Class II.

**§ 892.1715 Full-field digital mammography system.**

(a) *Identification.* A full-field digital mammography system is a device intended to produce planar digital x-ray images of the entire breast. This generic type of device may include digital mammography acquisition software, full-field digital image receptor, acquisition workstation, automatic exposure control, image processing and reconstruction programs, patient and equipment supports, component parts, and accessories.

(b) *Classification.* Class II (special controls). The special control for the device is FDA's guidance document entitled "Class II Special Controls Guidance Document: Full-Field Digital Mammography System." See § 892.1(e) for the availability of this guidance document.

[75 FR 68203, Nov. 5, 2010]

**§ 892.1720 Mobile x-ray system.**

(a) *Identification.* A mobile x-ray system is a transportable device system intended to be used to generate and control x-ray for diagnostic procedures. This generic type of device may include signal analysis and display equipment, patient and equipment supports, component parts, and accessories.

(b) *Classification.* Class II.

**§ 892.1730 Photofluorographic x-ray system.**

(a) *Identification.* A photofluorographic x-ray system is a device that includes a fluoroscopic x-ray unit and a camera intended to be used to produce, then photograph, a fluoroscopic image of the body. This generic type of device may include signal analysis and display equipment, patient and equipment supports, component parts, and accessories.

(b) *Classification.* Class II (special controls). A discography kit intended for use with a photofluorographic x-ray system only is exempt from the premarket notification procedures in subpart E of part 807 of this chapter subject to the limitations in § 892.9.

[48 FR 53047, Nov. 23, 1983, as amended at 84 FR 71819, Dec. 30, 2019]

**§ 892.1740 Tomographic x-ray system.**

(a) *Identification.* A tomographic x-ray system is an x-ray device intended to be used to produce radiologic images of a specific cross-sectional plane of the body by blurring or eliminating detail from other planes. This generic type of device may include signal analysis and display equipment, patient and equipment supports, component parts, and accessories.

(b) *Classification.* Class II.

**§ 892.1750 Computed tomography x-ray system.**

(a) *Identification.* A computed tomography x-ray system is a diagnostic x-ray system intended to produce cross-sectional images of the body by computer reconstruction of x-ray transmission data from the same axial plane taken at different angles. This generic type of device may include signal analysis and display equipment, patient and equipment supports, component parts, and accessories.

(b) *Classification.* Class II.

**§ 892.1760 Diagnostic x-ray tube housing assembly.**

(a) *Identification.* A diagnostic x-ray tube housing assembly is an x-ray generating tube encased in a radiation-shielded housing that is intended for diagnostic purposes. This generic type of device may include high voltage and

**§ 892.1770**

filament transformers or other appropriate components.

(b) *Classification.* Class I (general controls). The device is exempt from the premarket notification procedures in subpart E of part 807 of this chapter, subject to the limitations in § 892.9.

[53 FR 1567, Jan. 20, 1988, as amended at 61 FR 1125, Jan. 16, 1996; 66 FR 38819, July 25, 2001]

**§ 892.1770 Diagnostic x-ray tube mount.**

(a) *Identification.* A diagnostic x-ray tube mount is a device intended to support and to position the diagnostic x-ray tube housing assembly for a medical radiographic procedure.

(b) *Classification.* Class I (general controls). The device is exempt from the premarket notification procedures in subpart E of part 807 of this chapter, subject to the limitations in § 892.9.

[53 FR 1567, Jan. 20, 1988, as amended at 61 FR 1125, Jan. 16, 1996; 66 FR 38819, July 25, 2001]

**§ 892.1820 Pneumoencephalographic chair.**

(a) *Identification.* A pneumoencephalographic chair is a chair intended to support and position a patient during pneumoencephalography (x-ray imaging of the brain).

(b) *Classification.* Class II (special controls). The device is exempt from the premarket notification procedures in subpart E of part 807 of this chapter subject to the limitations in § 892.9.

[48 FR 53047, Nov. 23, 1983, as amended at 84 FR 71819, Dec. 30, 2019]

**§ 892.1830 Radiologic patient cradle.**

(a) *Identification.* A radiologic patient cradle is a support device intended to be used for rotational positioning about the longitudinal axis of a patient during radiologic procedures.

(b) *Classification.* Class I (general controls). The device is exempt from the premarket notification procedures in subpart E of part 807 of this chapter, subject to the limitations in § 892.9.

[53 FR 1567, Jan. 20, 1988, as amended at 61 FR 1125, Jan. 16, 1996; 66 FR 38819, July 25, 2001]

**21 CFR Ch. I (4–1–20 Edition)**

**§ 892.1840 Radiographic film.**

(a) *Identification.* Radiographic film is a device that consists of a thin sheet of radiotransparent material coated on one or both sides with a photographic emulsion intended to record images during diagnostic radiologic procedures.

(b) *Classification.* Class I (general controls). The device is exempt from the premarket notification procedures in subpart E of part 807 of this chapter, subject to the limitations in § 892.9.

[53 FR 1567, Jan. 20, 1988, as amended at 66 FR 38819, July 25, 2001]

**§ 892.1850 Radiographic film cassette.**

(a) *Identification.* A radiographic film cassette is a device intended for use during diagnostic x-ray procedures to hold a radiographic film in close contact with an x-ray intensifying screen and to provide a light-proof enclosure for direct exposure of radiographic film.

(b) *Classification.* Class II (special controls). The device is exempt from the premarket notification procedures in subpart E of part 807 of this chapter subject to the limitations in § 892.9.

[48 FR 53047, Nov. 23, 1983, as amended at 84 FR 71819, Dec. 30, 2019]

**§ 892.1860 Radiographic film/cassette changer.**

(a) *Identification.* A radiographic film/cassette changer is a device intended to be used during a radiologic procedure to move a radiographic film or cassette between x-ray exposures and to position it during the exposure.

(b) *Classification.* Class II (special controls). The device is exempt from the premarket notification procedures in subpart E of part 807 of this chapter subject to the limitations in § 892.9.

[48 FR 53047, Nov. 23, 1983, as amended at 84 FR 71819, Dec. 30, 2019]

**§ 892.1870 Radiographic film/cassette changer programmer.**

(a) *Identification.* A radiographic film/cassette changer programmer is a device intended to be used to control the operations of a film or cassette changer during serial medical radiography.

(b) *Classification.* Class II (special controls). The device is exempt from

the premarket notification procedures in subpart E of part 807 of this chapter subject to the limitations in § 892.9.

[48 FR 53047, Nov. 23, 1983, as amended at 84 FR 71819, Dec. 30, 2019]

**§ 892.1880 Wall-mounted radiographic cassette holder.**

(a) *Identification.* A wall-mounted radiographic cassette holder is a device that is a support intended to hold and position radiographic cassettes for a radiographic exposure for medical use.

(b) *Classification.* Class I (general controls). The device is exempt from the premarket notification procedures in subpart E of part 807 of this chapter, subject to the limitations in § 892.9.

[53 FR 1567, Jan. 20, 1988, as amended at 61 FR 1125, Jan. 16, 1996; 66 FR 38819, July 25, 2001]

**§ 892.1890 Radiographic film illuminator.**

(a) *Identification.* A radiographic film illuminator is a device containing a visible light source covered with a translucent front that is intended to be used to view medical radiographs.

(b) *Classification.* Class I (general controls). The device is exempt from the premarket notification procedures in subpart E of part 807 of this chapter subject to § 892.9.

[55 FR 48444, Nov. 20, 1990, as amended at 65 FR 2323, Jan. 14, 2000]

**§ 892.1900 Automatic radiographic film processor.**

(a) *Identification.* An automatic radiographic film processor is a device intended to be used to develop, fix, wash, and dry automatically and continuously film exposed for medical purposes.

(b) *Classification.* Class II (special controls). The device is exempt from the premarket notification procedures in subpart E of part 807 of this chapter subject to the limitations in § 892.9.

[55 FR 48444, Nov. 20, 1990, as amended at 84 FR 71819, Dec. 30, 2019]

**§ 892.1910 Radiographic grid.**

(a) *Identification.* A radiographic grid is a device that consists of alternating radiolucent and radiopaque strips intended to be placed between the pa-

tient and the image receptor to reduce the amount of scattered radiation reaching the image receptor.

(b) *Classification.* Class I (general controls). The device is exempt from the premarket notification procedures in subpart E of part 807 of this chapter subject to § 892.9.

[53 FR 1567, Jan. 20, 1988, as amended at 65 FR 2323, Jan. 14, 2000]

**§ 892.1920 Radiographic head holder.**

(a) *Identification.* A radiographic head holder is a device intended to position the patient's head during a radiographic procedure.

(b) *Classification.* Class I (general controls). The device is exempt from the premarket notification procedures in subpart E of part 807 of this chapter, subject to the limitations in § 892.9. The device is also exempt from the current good manufacturing practice requirements of the quality system regulation in part 820 of this chapter, with the exception of § 820.180, with respect to general requirements concerning records, and § 820.198, with respect to complaint files.

[53 FR 1567, Jan. 20, 1988, as amended at 66 FR 38819, July 25, 2001]

**§ 892.1940 Radiologic quality assurance instrument.**

(a) *Identification.* A radiologic quality assurance instrument is a device intended for medical purposes to measure a physical characteristic associated with another radiologic device.

(b) *Classification.* Class I (general controls). The device is exempt from the premarket notification procedures in subpart E of part 807 of this chapter, subject to the limitations in § 892.9. The device is also exempt from the current good manufacturing practice requirements of the quality system regulation in part 820 of this chapter, with the exception of § 820.180, with respect to general requirements concerning records, and § 820.198, with respect to complaint files.

[53 FR 1567, Jan. 20, 1988, as amended at 66 FR 38819, July 25, 2001]

**§ 892.1950**

**21 CFR Ch. I (4–1–20 Edition)**

**§ 892.1950 Radiographic anthropomorphic phantom.**

(a) *Identification.* A radiographic anthropomorphic phantom is a device intended for medical purposes to simulate a human body for positioning radiographic equipment.

(b) *Classification.* Class I (general controls). The device is exempt from the premarket notification procedures in subpart E of part 807 of this chapter, subject to the limitations in § 892.9. The device is also exempt from the current good manufacturing practice requirements of the quality system regulation in part 820 of this chapter, with the exception of § 820.180, with respect to general requirements concerning records, and § 820.198, with respect to complaint files.

[53 FR 1567, Jan. 20, 1988, as amended at 66 FR 38819, July 25, 2001]

**§ 892.1960 Radiographic intensifying screen.**

(a) *Identification.* A radiographic intensifying screen is a device that is a thin radiolucent sheet coated with a luminescent material that transforms incident x-ray photons into visible light and intended for medical purposes to expose radiographic film.

(b) *Classification.* Class I (general controls). The device is exempt from the premarket notification procedures in subpart E of part 807 of this chapter subject to § 892.9.

[53 FR 1567, Jan. 20, 1988, as amended at 65 FR 2323, Jan. 14, 2000]

**§ 892.1970 Radiographic ECG/respirator synchronizer.**

(a) *Identification.* A radiographic ECG/respirator synchronizer is a device intended to be used to coordinate an x-ray film exposure with the signal from an electrocardiograph (ECG) or respirator at a predetermined phase of the cardiac or respiratory cycle.

(b) *Classification.* Class I (general controls). The device is exempt from the premarket notification procedures in subpart E of part 807 of this chapter subject to § 892.9.

[55 FR 48444, Nov. 20, 1990, as amended at 65 FR 2323, Jan. 14, 2000]

**§ 892.1980 Radiologic table.**

(a) *Identification.* A radiologic table is a device intended for medical purposes to support a patient during radiologic procedures. The table may be fixed or tilting and may be electrically powered.

(b) *Classification.* Class II (special controls). The device is exempt from the premarket notification procedures in subpart E of part 807 of this chapter subject to § 892.9.

[53 FR 1567, Jan. 20, 1988, as amended at 63 FR 59231, Nov. 3, 1998]

**§ 892.1990 Transilluminator for breast evaluation.**

(a) *Identification.* A transilluminator, also known as a diaphanoscope or lightscanner, is an electrically powered device that uses low intensity emissions of visible light and near-infrared radiation (approximately 700–1050 nanometers (nm)), transmitted through the breast, to visualize translucent tissue for the diagnosis of cancer, other conditions, diseases, or abnormalities.

(b) *Classification.* Class III (premarket approval).

(c) *Date premarket approval (PMA) or notice of completion of product development protocol (PDP) is required.* A PMA or notice of completion of a PDP is required to be filed with FDA by April 17, 2014, for any transilluminator for breast evaluation that was in commercial distribution before May 28, 1976, or that has, by April 17, 2014, been found to be substantially equivalent to any transilluminator for breast evaluation that was in commercial distribution before May 28, 1976. Any other transilluminator for breast evaluation shall have an approved PMA or declared completed PDP in effect before being placed in commercial distribution.

[60 FR 36639, July 18, 1995, as amended at 79 FR 3094, Jan. 17, 2014]

**§ 892.2010 Medical image storage device.**

(a) *Identification.* A medical image storage device is a device that provides electronic storage and retrieval functions for medical images. Examples include devices employing magnetic and



optical discs, magnetic tape, and digital memory.

(b) *Classification.* Class I (general controls). The device is exempt from the premarket notification procedures in subpart E of part 807 of this chapter subject to § 892.9.

[63 FR 23387, Apr. 29, 1998; 63 FR 44998, Aug. 24, 1998, as amended at 65 FR 2323, Jan. 14, 2000]

**§ 892.2020 Medical image communications device.**

(a) *Identification.* A medical image communications device provides electronic transfer of medical image data between medical devices. It may include a physical communications medium, modems, interfaces, and a communications protocol.

(b) *Classification.* Class I (general controls). The device is exempt from the premarket notification procedures in subpart E of part 807 of this chapter subject to § 892.9.

[63 FR 23387, Apr. 29, 1998; 63 FR 44998, Aug. 24, 1998, as amended at 65 FR 2323, Jan. 14, 2000]

**§ 892.2030 Medical image digitizer.**

(a) *Identification.* A medical image digitizer is a device intended to convert an analog medical image into a digital format. Examples include systems employing video frame grabbers, and scanners which use lasers or charge-coupled devices.

(b) *Classification.* Class II (special controls; voluntary standards—Digital Imaging and Communications in Medicine (DICOM) Std., Joint Photographic Experts Group (JPEG) Std.). The device is exempt from the premarket notification procedures in subpart E of part 807 of this chapter subject to the limitations in § 892.9.

[63 FR 23387, Apr. 29, 1998, as amended at 84 FR 71819, Dec. 30, 2019]

**§ 892.2040 Medical image hardcopy device.**

(a) *Identification.* A medical image hardcopy device is a device that produces a visible printed record of a medical image and associated identification information. Examples include multifunction cameras and laser printers.

(b) *Classification.* Class II (special controls; voluntary standards—Digital Imaging and Communications in Medicine (DICOM) Std., Joint Photographic Experts Group (JPEG) Std., Society of Motion Picture and Television Engineers (SMPTE) Test Pattern). The device is exempt from the premarket notification procedures in subpart E of part 807 of this chapter subject to the limitations in § 892.9.

[63 FR 23387, Apr. 29, 1998, as amended at 84 FR 71819, Dec. 30, 2019]

**§ 892.2050 Picture archiving and communications system.**

(a) *Identification.* A picture archiving and communications system is a device that provides one or more capabilities relating to the acceptance, transfer, display, storage, and digital processing of medical images. Its hardware components may include workstations, digitizers, communications devices, computers, video monitors, magnetic, optical disk, or other digital data storage devices, and hardcopy devices. The software components may provide functions for performing operations related to image manipulation, enhancement, compression or quantification.

(b) *Classification.* Class II (special controls; voluntary standards—Digital Imaging and Communications in Medicine (DICOM) Std., Joint Photographic Experts Group (JPEG) Std., Society of Motion Picture and Television Engineers (SMPTE) Test Pattern).

[63 FR 23387, Apr. 29, 1998]

**§ 892.2060 Radiological computer-assisted diagnostic software for lesions suspicious of cancer.**

(a) *Identification.* A radiological computer-assisted diagnostic software for lesions suspicious of cancer is an image processing prescription device intended to aid in the characterization of lesions as suspicious for cancer identified on acquired medical images such as magnetic resonance, mammography, radiography, or computed tomography. The device characterizes lesions based on features or information extracted from the images and provides information about the lesion(s) to the user. Diagnostic and patient management decisions are made by the clinical user.

(b) *Classification.* Class II (special controls). The special controls for this device are:

(1) Design verification and validation must include:

(i) A detailed description of the image analysis algorithms including, but not limited to, a detailed description of the algorithm inputs and outputs, each major component or block, and algorithm limitations.

(ii) A detailed description of pre-specified performance testing protocols and dataset(s) used to assess whether the device will improve reader performance as intended.

(iii) Results from performance testing protocols that demonstrate that the device improves reader performance in the intended use population when used in accordance with the instructions for use. The performance assessment must be based on appropriate diagnostic accuracy measures (*e.g.*, receiver operator characteristic plot, sensitivity, specificity, predictive value, and diagnostic likelihood ratio). The test dataset must contain sufficient numbers of cases from important cohorts (*e.g.*, subsets defined by clinically relevant confounders, effect modifiers, concomitant diseases, and subsets defined by image acquisition characteristics) such that the performance estimates and confidence intervals of the device for these individual subsets can be characterized for the intended use population and imaging equipment.

(iv) Standalone performance testing protocols and results of the device.

(v) Appropriate software documentation (*e.g.*, device hazard analysis; software requirements specification document; software design specification document; traceability analysis; and description of verification and validation activities including system level test protocol, pass/fail criteria, results, and cybersecurity).

(2) Labeling must include:

(i) A detailed description of the patient population for which the device is indicated for use.

(ii) A detailed description of the intended reading protocol.

(iii) A detailed description of the intended user and recommended user training.

(iv) A detailed description of the device inputs and outputs.

(v) A detailed description of compatible imaging hardware and imaging protocols.

(vi) Warnings, precautions, and limitations, including situations in which the device may fail or may not operate at its expected performance level (*e.g.*, poor image quality or for certain sub-populations), as applicable.

(vii) Detailed instructions for use.

(viii) A detailed summary of the performance testing, including: Test methods, dataset characteristics, results, and a summary of sub-analyses on case distributions stratified by relevant confounders (*e.g.*, lesion and organ characteristics, disease stages, and imaging equipment).

[85 FR 3542, Jan. 22, 2020]

**§ 892.2070 Medical image analyzer.**

(a) *Identification.* Medical image analyzers, including computer-assisted/aided detection (CADe) devices for mammography breast cancer, ultrasound breast lesions, radiograph lung nodules, and radiograph dental caries detection, is a prescription device that is intended to identify, mark, highlight, or in any other manner direct the clinicians' attention to portions of a radiology image that may reveal abnormalities during interpretation of patient radiology images by the clinicians. This device incorporates pattern recognition and data analysis capabilities and operates on previously acquired medical images. This device is not intended to replace the review by a qualified radiologist, and is not intended to be used for triage, or to recommend diagnosis.

(b) *Classification.* Class II (special controls). The special controls for this device are:

(1) Design verification and validation must include:

(i) A detailed description of the image analysis algorithms including a description of the algorithm inputs and outputs, each major component or block, and algorithm limitations.

(ii) A detailed description of pre-specified performance testing methods and dataset(s) used to assess whether the device will improve reader performance as intended and to characterize the

standalone device performance. Performance testing includes one or more standalone tests, side-by-side comparisons, or a reader study, as applicable.

(iii) Results from performance testing that demonstrate that the device improves reader performance in the intended use population when used in accordance with the instructions for use. The performance assessment must be based on appropriate diagnostic accuracy measures (*e.g.*, receiver operator characteristic plot, sensitivity, specificity, predictive value, and diagnostic likelihood ratio). The test dataset must contain a sufficient number of cases from important cohorts (*e.g.*, subsets defined by clinically relevant confounders, effect modifiers, concomitant diseases, and subsets defined by image acquisition characteristics) such that the performance estimates and confidence intervals of the device for these individual subsets can be characterized for the intended use population and imaging equipment.

(iv) Appropriate software documentation (*e.g.*, device hazard analysis; software requirements specification document; software design specification document; traceability analysis; description of verification and validation activities including system level test protocol, pass/fail criteria, and results; and cybersecurity).

(2) Labeling must include the following:

(i) A detailed description of the patient population for which the device is indicated for use.

(ii) A detailed description of the intended reading protocol.

(iii) A detailed description of the intended user and user training that addresses appropriate reading protocols for the device.

(iv) A detailed description of the device inputs and outputs.

(v) A detailed description of compatible imaging hardware and imaging protocols.

(vi) Discussion of warnings, precautions, and limitations must include situations in which the device may fail or may not operate at its expected performance level (*e.g.*, poor image quality or for certain subpopulations), as applicable.

(vii) Device operating instructions.

(viii) A detailed summary of the performance testing, including: test methods, dataset characteristics, results, and a summary of sub-analyses on case distributions stratified by relevant confounders, such as lesion and organ characteristics, disease stages, and imaging equipment.

[85 FR 3548, Jan. 22, 2020]

**§ 892.2080 Radiological computer aided triage and notification software.**

(a) *Identification.* Radiological computer aided triage and notification software is an image processing prescription device intended to aid in prioritization and triage of radiological medical images. The device notifies a designated list of clinicians of the availability of time sensitive radiological medical images for review based on computer aided image analysis of those images performed by the device. The device does not mark, highlight, or direct users' attention to a specific location in the original image. The device does not remove cases from a reading queue. The device operates in parallel with the standard of care, which remains the default option for all cases.

(b) *Classification.* Class II (special controls). The special controls for this device are:

(1) Design verification and validation must include:

(i) A detailed description of the notification and triage algorithms and all underlying image analysis algorithms including, but not limited to, a detailed description of the algorithm inputs and outputs, each major component or block, how the algorithm affects or relates to clinical practice or patient care, and any algorithm limitations.

(ii) A detailed description of pre-specified performance testing protocols and dataset(s) used to assess whether the device will provide effective triage (*e.g.*, improved time to review of prioritized images for pre-specified clinicians).

(iii) Results from performance testing that demonstrate that the device will provide effective triage. The performance assessment must be based on an appropriate measure to estimate the

**§ 892.5050**

clinical effectiveness. The test dataset must contain sufficient numbers of cases from important cohorts (*e.g.*, subsets defined by clinically relevant confounders, effect modifiers, associated diseases, and subsets defined by image acquisition characteristics) such that the performance estimates and confidence intervals for these individual subsets can be characterized with the device for the intended use population and imaging equipment.

(iv) Stand-alone performance testing protocols and results of the device.

(v) Appropriate software documentation (*e.g.*, device hazard analysis; software requirements specification document; software design specification document; traceability analysis; description of verification and validation activities including system level test protocol, pass/fail criteria, and results).

(2) Labeling must include the following:

(i) A detailed description of the patient population for which the device is indicated for use;

(ii) A detailed description of the intended user and user training that addresses appropriate use protocols for the device;

(iii) Discussion of warnings, precautions, and limitations must include situations in which the device may fail or may not operate at its expected performance level (*e.g.*, poor image quality for certain subpopulations), as applicable;

(iv) A detailed description of compatible imaging hardware, imaging protocols, and requirements for input images;

(v) Device operating instructions; and

(vi) A detailed summary of the performance testing, including: test methods, dataset characteristics, triage effectiveness (*e.g.*, improved time to review of prioritized images for pre-specified clinicians), diagnostic accuracy of algorithms informing triage decision, and results with associated statistical uncertainty (*e.g.*, confidence intervals), including a summary of subanalyses on case distributions stratified by relevant confounders, such as lesion and organ characteristics, disease stages, and imaging equipment.

[85 FR 3544, Jan. 22, 2020]

**21 CFR Ch. I (4–1–20 Edition)**

**Subparts C–E [Reserved]**

**Subpart F—Therapeutic Devices**

**§ 892.5050 Medical charged-particle radiation therapy system.**

(a) *Identification.* A medical charged-particle radiation therapy system is a device that produces by acceleration high energy charged particles (*e.g.*, electrons and protons) intended for use in radiation therapy. This generic type of device may include signal analysis and display equipment, patient and equipment supports, treatment planning computer programs, component parts, and accessories.

(b) *Classification.* Class II. When intended for use as a quality control system, the film dosimetry system (film scanning system) included as an accessory to the device described in paragraph (a) of this section, is exempt from the premarket notification procedures in subpart E of part 807 of this chapter subject to the limitations in § 892.9.

[53 FR 1567, Jan. 20, 1988, as amended at 64 FR 1125, Jan. 8, 1999]

**§ 892.5300 Medical neutron radiation therapy system.**

(a) *Identification.* A medical neutron radiation therapy system is a device intended to generate high-energy neutrons for radiation therapy. This generic type of device may include signal analysis and display equipment, patient and equipment support, treatment planning computer programs, component parts, and accessories.

(b) *Classification.* Class II.

**§ 892.5650 Manual radionuclide applicator system.**

(a) *Identification.* A manual radionuclide applicator system is a manually operated device intended to apply a radionuclide source into the body or to the surface of the body for radiation therapy. This generic type of device may include patient and equipment supports, component parts, treatment planning computer programs, and accessories.

(b) *Classification.* Class I (general controls). The device is exempt from the premarket notification procedures in

subpart E of part 807 of this chapter subject to § 892.9.

[53 FR 1567, Jan. 20, 1988, as amended at 65 FR 2323, Jan. 14, 2000]

**§ 892.5700 Remote controlled radionuclide applicator system.**

(a) *Identification.* A remote controlled radionuclide applicator system is an electromechanical or pneumatic device intended to enable an operator to apply, by remote control, a radionuclide source into the body or to the surface of the body for radiation therapy. This generic type of device may include patient and equipment supports, component parts, treatment planning computer programs, and accessories.

(b) *Classification.* Class II.

**§ 892.5710 Radiation therapy beam-shaping block.**

(a) *Identification.* A radiation therapy beam-shaping block is a device made of a highly attenuating material (such as lead) intended for medical purposes to modify the shape of a beam from a radiation therapy source.

(b) *Classification.* Class II.

**§ 892.5720 Rectal balloon for prostate immobilization.**

(a) *Identification.* A rectal balloon for prostate immobilization is a single use, inflatable, non-powered positioning device placed in the rectum to immobilize the prostate in patients undergoing radiation therapy. The device is intended to be used during all the phases of radiation therapy, including treatment planning, image verification, and radiotherapy delivery.

(b) *Classification.* Class II (special controls). The special controls for this device are:

(1) The premarket notification submission must include methodology and results of the following non-clinical and clinical performance testing:

(i) Biocompatibility testing of the final finished device;

(ii) If provided sterile, sterilization validation;

(iii) If not provided sterile, bioburden testing of the final finished device;

(iv) Shelf life and expiration date validation; and

(v) Performance testing including but not limited to:

(A) Venting mechanism (if device has a vent mechanism);

(B) Safety mechanism(s) to prevent advancement beyond its intended safe placement; and

(C) Structural integrity testing (*e.g.*, tensile strength, balloon leakage and burst strength).

(2) Labeling that includes:

(i) Appropriate warnings and contraindications, including, but not limited to the following statements:

(A) “Do not transport the patient with the rectal balloon inserted. The balloon should be removed prior to transport.”;

(B) “Failure to perform the standard imaging position verification protocol may cause the device to not perform as intended.”;

(C) “Reduce the rectal balloon fill volume if the patient experiences discomfort due to the rectal balloon inflation.”; and

(D) “Do not apply excessive pressure/force on the shaft or tubing of the rectal balloon.”

(ii) Adequate instructions for use on the proper insertion procedure, positioning, and inflation of the rectal balloon;

(iii) Whether the device is sterile or non-sterile; and

(iv) An expiration date.

[82 FR 61171, Dec. 27, 2017]

**§ 892.5725 Absorbable perirectal spacer.**

(a) *Identification.* An absorbable perirectal spacer is composed of biodegradable material that temporarily positions the anterior rectal wall away from the prostate during radiotherapy for prostate cancer with the intent to reduce the radiation dose delivered to the anterior rectum. The absorbable spacer maintains space for the entire course of prostate radiotherapy treatment and is completely absorbed by the patient’s body over time.

(b) *Classification.* Class II (special controls). The special controls for this device are:

(1) The premarket notification submission must include methodology and results of the following non-clinical and clinical performance testing. For

## § 892.5730

all clinical investigations used to support premarket notification submissions for this type of device, line listings of the study data must be provided.

(i) Performance bench testing must demonstrate appropriate perirectal space creation and maintenance for the duration of prostate radiotherapy.

(ii) Performance bench testing must demonstrate that therapeutic radiation levels do not alter the performance of the device.

(iii) Performance in vivo testing must demonstrate appropriate deployment of spacer as indicated in the accompanying labeling, and demonstrate appropriate expansion and absorption characteristics in a clinically relevant environment.

(iv) Clinical study must demonstrate appropriate spacer stability and lack of migration for the entire course of radiotherapy, complete absorption, and lack of long term toxicity.

(v) Sterility testing must demonstrate the sterility of the device and the effects of the sterilization process on the physical characteristics of the spacer.

(vi) Shelf-life testing must demonstrate the stability of the physical characteristics of the spacer throughout the shelf-life as indicated in the accompanying labeling.

(vii) The device must be demonstrated to be biocompatible.

(2) The risk management activities performed as part of the manufacturer's §820.30 design controls must document an appropriate end user initial training program which will be offered as part of efforts to mitigate the risk of failure to correctly operate the device, including, but not limited to, documentation of an appropriate end user initial training program on the proper spacer deployment technique.

(3) The device labeling must include the following:

(i) A detailed summary of reported or observed complications related to the use of the device;

(ii) Appropriate warnings;

(iii) Detailed instructions for system preparations and detailed implant procedure instructions; and

(iv) An expiration date that is supported by performance data as speci-

## 21 CFR Ch. I (4–1–20 Edition)

fied in paragraph (b)(1)(vi) of this section.

[83 FR 601, Jan. 5, 2018]

### § 892.5730 Radionuclide brachytherapy source.

(a) *Identification.* A radionuclide brachytherapy source is a device that consists of a radionuclide which may be enclosed in a sealed container made of gold, titanium, stainless steel, or platinum and intended for medical purposes to be placed onto a body surface or into a body cavity or tissue as a source of nuclear radiation for therapy.

(b) *Classification.* Class II (special controls). A prostate seeding kit intended for use with a radionuclide brachytherapy source only is exempt from the premarket notification procedures in subpart E of part 807 of this chapter subject to the limitations in §892.9.

[48 FR 53047, Nov. 23, 1983, as amended at 84 FR 71819, Dec. 30, 2019]

### § 892.5740 Radionuclide teletherapy source.

(a) *Identification.* A radionuclide teletherapy source is a device consisting of a radionuclide enclosed in a sealed container. The device is intended for radiation therapy, with the radiation source located at a distance from the patient's body.

(b) *Classification.* Class I (general controls). The device is exempt from the premarket notification procedures in subpart E of part 807 of this chapter, subject to the limitations in §892.9.

[53 FR 1567, Jan. 20, 1988, as amended at 59 FR 63015, Dec. 7, 1994; 66 FR 38819, July 25, 2001]

### § 892.5750 Radionuclide radiation therapy system.

(a) *Identification.* A radionuclide radiation therapy system is a device intended to permit an operator to administer gamma radiation therapy, with the radiation source located at a distance from the patient's body. This generic type of device may include signal analysis and display equipment, patient and equipment supports, treatment planning computer programs, component parts (including beam-limiting devices), and accessories.

(b) *Classification*. Class II.

**§ 892.5770 Powered radiation therapy patient support assembly.**

(a) *Identification*. A powered radiation therapy patient support assembly is an electrically powered adjustable couch intended to support a patient during radiation therapy.

(b) *Classification*. Class II.

**§ 892.5780 Light beam patient position indicator.**

(a) *Identification*. A light beam patient position indicator is a device that projects a beam of light (incoherent light or laser) to determine the alignment of the patient with a radiation beam. The beam of light is intended to be used during radiologic procedures to ensure proper positioning of the patient and to monitor alignment of the radiation beam with the patient's anatomy.

(b) *Classification*. Class I (general controls). The device is exempt from the premarket notification procedures in subpart E of part 807 of this chapter, subject to the limitations in § 892.9.

[53 FR 1567, Jan. 20, 1988, as amended at 61 FR 1125, Jan. 16, 1996; 66 FR 38819, July 25, 2001]

**§ 892.5840 Radiation therapy simulation system.**

(a) *Identification*. A radiation therapy simulation system is a fluoroscopic or radiographic x-ray system intended for use in localizing the volume to be exposed during radiation therapy and confirming the position and size of the therapeutic irradiation field produced. This generic type of device may include signal analysis and display equipment, patient and equipment supports, treatment planning computer programs, component parts, and accessories.

(b) *Classification*. Class II.

**§ 892.5900 X-ray radiation therapy system.**

(a) *Identification*. An x-ray radiation therapy system is a device intended to produce and control x-rays used for radiation therapy. This generic type of device may include signal analysis and display equipment, patient and equipment supports, treatment planning

computer programs, component parts, and accessories.

(b) *Classification*. Class II.

**§ 892.5930 Therapeutic x-ray tube housing assembly.**

(a) *Identification*. A therapeutic x-ray tube housing assembly is an x-ray generating tube encased in a radiation-shielded housing intended for use in radiation therapy. This generic type of device may include high-voltage and filament transformers or other appropriate components when contained in radiation-shielded housing.

(b) *Classification*. Class II.

**Subpart G—Miscellaneous Devices**

**§ 892.6500 Personnel protective shield.**

(a) *Identification*. A personnel protective shield is a device intended for medical purposes to protect the patient, the operator, or other persons from unnecessary exposure to radiation during radiologic procedures by providing an attenuating barrier to radiation. This generic type of device may include articles of clothing, furniture, and movable or stationary structures.

(b) *Classification*. Class I (general controls). The device is exempt from the premarket notification procedures in subpart E of part 807 of this chapter subject to § 892.9.

[53 FR 1567, Jan. 20, 1988, as amended at 61 FR 1125, Jan. 16, 1996; 65 FR 2323, Jan. 14, 2000]

**PART 895—BANNED DEVICES**

**Subpart A—General Provisions**

Sec.

895.1 Scope.

895.20 General.

895.21 Procedures for banning a device.

895.22 Submission of data and information by the manufacturer, distributor, or importer.

895.25 Labeling.

895.30 Special effective date.

**Subpart B—Listing of Banned Devices**

895.101 Prosthetic hair fibers.

895.102 Powdered surgeon's glove.

895.103 Powdered patient examination glove.

## § 895.1

895.104 Absorbable powder for lubricating a surgeon's glove.

895.105 Electrical stimulation devices for self-injurious or aggressive behavior.

AUTHORITY: 21 U.S.C. 352, 360f, 360h, 360i, 371.

SOURCE: 44 FR 29221, May 18, 1979, unless otherwise noted.

### Subpart A—General Provisions

#### § 895.1 Scope.

(a) This part describes the procedures by which the Commissioner may institute proceedings to make a device intended for human use that presents substantial deception or an unreasonable and substantial risk of illness or injury a banned device.

(b) This part applies to any "device", as defined in section 201(h) of the Federal Food, Drug, and Cosmetic Act (act) that is intended for human use.

(c) A device that is made a banned device in accordance with this part is adulterated under section 501(g) of the act. A restricted device that is banned may also be misbranded under section 502(q) of the act.

(d) Although this part does not cover devices intended for animal use, the manufacturer, distributor, importer, or any other person(s) responsible for the labeling of the device that is banned cannot avoid the ban by relabeling the device for veterinary use. A device that has been banned from human use but that also has a valid veterinary use may be marketed for use as a veterinary device only under the following conditions: The device shall comply with all requirements applicable to veterinary devices under the Federal Food, Drug, and Cosmetic Act and this chapter, and the label for the device shall bear the following statement: "For Veterinary Use Only. Caution: Federal law prohibits the distribution of this device for human use." A device so labeled, however, that is determined by the Food and Drug Administration to be intended for human use, will be considered to be a banned device. In determining whether such a device is intended for human use, the Food and Drug Administration will consider, among other things, the ultimate destination of the device.

## 21 CFR Ch. I (4-1-20 Edition)

#### § 895.20 General.

The Commissioner may initiate a proceeding to make a device a banned device whenever the Commissioner finds, on the basis of all available data and information, that the device presents substantial deception or an unreasonable and substantial risk of illness or injury that the Commissioner determines cannot be, or has not been, corrected or eliminated by labeling or by a change in labeling, or by a change in advertising if the device is a restricted device.

[44 FR 29221, May 18, 1979, as amended at 57 FR 58405, Dec. 10, 1992]

#### § 895.21 Procedures for banning a device.

(a) Before initiating a proceeding to make a device a banned device, the Commissioner shall find that the continued marketing of the device presents a substantial deception or an unreasonable and substantial risk of illness or injury.

(1) In determining whether the deception or risk of illness or injury is substantial, the Commissioner will consider whether the deception or risk posed by continued marketing of the device, or continued marketing of the device as presently labeled, is important, material, or significant in relation to the benefit to the public health from its continued marketing.

(2) In determining whether a device is deceptive, the Commissioner will consider whether users of the device may be deceived or otherwise harmed by the device. The Commissioner is not required to determine that there was an intent on the part of the manufacturer, distributor, importer, or any other responsible person(s) to mislead or otherwise harm users of the device or that there exists any actual proof of deception of, or injury to, an individual.

(3) In determining whether a device presents deception or risk of illness or injury, the Commissioner will consider all available data and information, including data and information that the Commissioner may obtain under other provisions of the act, data and information that may be supplied by the manufacturer, distributor, or importer of the



device under §895.22, and data and information voluntarily submitted by any other interested persons.

(b) Before initiating a proceeding to make a device a banned device, the Commissioner of Food and Drugs (the Commissioner) may consult with the panel established under section 513 of the act that has expertise with respect to the type of device under consideration. The consultation with the panel may occur at a regular or specially scheduled panel meeting or may be accomplished by correspondence or telephone conversation with panel members. The Commissioner may request that the panel submit in writing any advice on the device under consideration. The Commissioner will record in written memoranda any oral communications with a panel or its members.

(c) If the Commissioner determines that any substantial deception or unreasonable and substantial risk of illness or injury or any unreasonable, direct, and substantial danger to the health of individuals presented by a device can be corrected or eliminated by labeling or change in labeling, or change in advertising if the device is a restricted device, the Commissioner will notify the responsible person of the required labeling or change in labeling or change in advertising in accordance with §895.25. If such required relabeling or change in advertising is not accomplished in accordance with §895.25, the Commissioner may initiate a proceeding to ban the device in accordance with §895.21(d) and, when appropriate, may establish a special effective date in accordance with §895.30.

(d) If the Commissioner decides to initiate a proceeding to make a device a banned device, a notice of proposed rulemaking will be published in the FEDERAL REGISTER to this effect. The notice will briefly summarize—

(1) The Commissioner's finding under paragraph (a) of this section that the device presents substantial deception or an unreasonable and substantial risk of illness or injury, and, when appropriate, the Commissioner's determination under §895.30 that the deception or risk of illness or injury presents an unreasonable, direct, and substantial danger to the health of individuals;

(2) The reasons why the Commissioner initiated the proceeding;

(3) The evaluation of data and information obtained under other provisions of the act, submitted by the manufacturer, distributor, or importer of the device, or voluntarily submitted by any other interested persons under paragraph (a)(3) of this section, if any;

(4) The consultation with the panel, if any, under paragraph (b) of this section;

(5) The determination as to whether the deception or risk of illness or injury or the danger to the health of individuals could be corrected by labeling or change in labeling, or change in advertising if the device is a restricted device;

(6) The determination of whether the required labeling or change of labeling, or change in advertising if the device is a restricted device, if any, has been made in accordance with paragraph (c) of this section;

(7) The determination as to whether, and the reasons why, the banning should apply to devices already in commercial distribution or those already sold to the ultimate user, or both; and

(8) Any other data and information that the Commissioner believes are pertinent to the proceeding. The notice will afford all interested persons an opportunity to submit written comments within 30 days after the date of publication of the proposed regulation. All nonconfidential information upon which the proposed finding is based, including the recommendations of the panel, will be available for public review in the Division of Dockets Management, Food and Drug Administration.

(e)(1) If, after reviewing the administrative record of the regulatory hearing before the Food and Drug Administration, if any, the written comments received on the proposed regulation, and any additional available data and information, the Commissioner determines to ban a device, a final regulation to this effect will be published in the FEDERAL REGISTER. The final regulation will amend subpart B by adding the name or description of the device, or both, to the list of banned devices.

(2) If the Commissioner determines not to ban the device, a notice of withdrawal and termination of rulemaking proceedings and reasons therefor will be published in the FEDERAL REGISTER.

(f) The effective date of a final regulation to make a device a banned device, promulgated under paragraph (e) of this section, will be the date of publication of the final regulation in the FEDERAL REGISTER unless the Commissioner, for reasons stated, determines that the effective date should be later than the date of the publication and specifies that date in the notice. Each such regulation will specify whether devices already in commercial distribution or sold to the ultimate user or both are banned.

(g) A regulation promulgated under paragraph (e) of this section is final agency action, subject to judicial review under section 517 of the act.

(h) Upon petition of any interested person submitted in accordance with § 10.30 of this chapter, or as a matter of discretion, the Commissioner may institute proceedings to amend or revoke a regulation that made a device a banned device if the Commissioner finds that the conditions that constituted the basis for the regulation banning the device are no longer applicable. When appropriate, the procedures in this section will be employed in such proceedings.

[44 FR 29221, May 18, 1979, as amended at 53 FR 11254, Apr. 6, 1988; 57 FR 58405, Dec. 10, 1992; 65 FR 43690, July 14, 2000]

**§ 895.22 Submission of data and information by the manufacturer, distributor, or importer.**

(a) A manufacturer, distributor, or importer of a device may be required to submit to the Food and Drug Administration all relevant and available data and information to enable the Commissioner to determine whether the device presents substantial deception, unreasonable and substantial risk of illness or injury, or unreasonable, direct, and substantial danger to the health of individuals. The data and information required by the Commissioner may include scientific or test data, reports, records, or other information, including data and information on whether the device is safe and effective for its

intended use or when used as directed, whether the device performs according to the claims made for the device, and information on adulteration or misbranding. Any relevant information that is voluntarily submitted will also be reviewed.

(b) A manufacturer, distributor, or importer of a device required to submit data and information as provided in paragraph (a) of this section will be notified in writing by the Food and Drug Administration that such data and information shall be submitted. The written notification will advise the manufacturer, distributor, or importer of the device that the purpose for the request is to enable the Commissioner to determine whether any of the conditions listed in paragraph (a) of this section or § 895.30(a)(1) exists with respect to the device such that a proceeding should be initiated to make the device a banned device. When the required data and information can be identified by the Food and Drug Administration at the time of the notification, the agency will provide such identification to the manufacturer, distributor, or importer of the device.

(c) The required data and information shall be submitted to the Food and Drug Administration no more than 30 days after the date of receipt of the request, unless the Commissioner determines that the data and information shall be submitted by some other date and so informs the manufacturer, distributor, or importer, in which case the data and information shall be submitted on the date specified by the Commissioner.

(d) If the data or information submitted to the Food and Drug Administration is sufficient to persuade the Commissioner that the deception or risk of illness or injury or the danger to the health of individuals presented by a device could be corrected or eliminated by labeling or change in labeling, or change in advertising if the device is a restricted device, the Commissioner will proceed in accordance with § 895.25.

(e) If the data or information submitted to the Food and Drug Administration is insufficient to show that the device does not present a substantial deception or an unreasonable and substantial risk of illness or injury, or an

unreasonable, direct, and substantial danger to the health of individuals, or if the manufacturer, distributor, or importer fails to submit the required information, the Commissioner may rely upon this insufficiency or failure to submit the required information in considering whether to initiate a proceeding to make the device a banned device under §895.21(d) and, when appropriate, to establish a special effective date in accordance with §895.30. The Commissioner may also initiate other regulatory action as provided in the act or this chapter.

**§ 895.25 Labeling.**

(a) If the Commissioner determines that the substantial deception or unreasonable and substantial risk of illness or injury or the unreasonable, direct, and substantial danger to the health of individuals presented by a device can be corrected or eliminated by labeling or a change in labeling, or change in advertising if the device is a restricted device, the Commissioner will provide written notice to the manufacturer, distributor, importer, or any other person(s) responsible for the labeling or advertising of the device specifying:

(1) The deception or risk of illness or injury or the danger to the health of individuals,

(2) The labeling or change in labeling, or change in advertising if the device is a restricted device, necessary to correct the deception or eliminate or reduce such risk or danger, and

(3) The period of time within which the labeling, change in labeling, or change in advertising must be accomplished.

(b) In specifying the labeling or change in labeling or change in advertising to correct the deception or to eliminate or reduce the risk of illness or injury or the danger to the health of individuals, the Commissioner may require the manufacturer, distributor, importer, or any other person(s) responsible for the labeling or advertising of the device to include in labeling for the device, and in advertising if the device is a restricted device, a statement, notice, or warning. Such statement, notice, or warning shall be in the manner and form prescribed by

the Commissioner and shall identify the deception or risk of illness or injury or the unreasonable, direct, and substantial danger to the health of individuals associated with the device as previously labeled. Such statement, notice, or warning shall be used in the labeling and advertising of the device for a time period specified by the Commissioner on the basis of the degree of deception, risk of illness or injury, or danger to health; the frequency of sale of the device; the length of time the device has been on the market; the intended uses of the device; the method of its use; and any other factors that the Commissioner considers pertinent.

(c) The Commissioner will allow a manufacturer, distributor, importer, or any other person(s) responsible for the labeling or advertising of the device a reasonable time, considering the deception or risk of illness or injury or the danger to the health of individuals presented by the device, within which to accomplish the required labeling, change in labeling, and, if the device is a restricted device, any change in advertising. The Commissioner may, however, request that no additional devices be introduced into commerce until the labeling or change in labeling, or change in advertising is accomplished by the manufacturer, distributor, importer, or other person(s) responsible for the labeling or advertising of the device.

(d) If such voluntary action is not taken, the Commissioner may take action under other sections of the act to prevent the introduction of the devices into commerce. The Commissioner may consider the failure of a manufacturer, distributor, importer, or any other person(s) responsible for the labeling or advertising of the device to accomplish the required labeling or change in labeling, or change in advertising in accordance with this section as a basis for initiating a proceeding to make a device a banned device in accordance with §895.21(d) and when appropriate to establish a special effective date in accordance with §895.30.

**§ 895.30 Special effective date.**

(a) The Commissioner may declare a proposed regulation under §895.21(d) to be effective upon its publication in the

## § 895.101

## 21 CFR Ch. I (4–1–20 Edition)

FEDERAL REGISTER and until the effective date of any final action taken respecting the regulation if:

(1) The Commissioner determines, on the basis of all available data and information, that the deception or risk of illness or injury associated with use of the device that is subject to the regulation presents an unreasonable, direct, and substantial danger to the health of individuals, and

(2) Before the date of the publication of such regulation, the Commissioner notifies the domestic manufacturer and importer, if any, of the device that the regulation is to be made so effective. If necessary, the Commissioner may also notify the distributor or any other responsible person(s). In addition, the Commissioner will attempt to notify any foreign manufacturer when the name and address of the foreign manufacturer are readily available.

(b) This procedure may be used when the Commissioner determines that the potential or actual injury involved is a serious one that the Commissioner believes will endanger the health of individuals who have been, or will be, exposed to the device. In assessing the degree of danger, the Commissioner need not find that the danger is immediate, and it shall be sufficient for the Commissioner to determine that the danger may involve a serious long-term risk.

(c) If the Commissioner makes a proposed regulation effective in accordance with this section, the Commissioner will, as expeditiously as possible, give interested persons prompt notice of this action in the FEDERAL REGISTER and will provide an opportunity for an informal hearing in accordance with part 16 of this chapter.

(d) After the hearing, if any, and after considering any written comments submitted on the proposal and any additional available information and data, the Commissioner will as expeditiously as possible either affirm, modify, or revoke the proposed regulation making the device a banned device. If the Commissioner decides to affirm or modify the proposed regulation to make a device a banned device, the Commissioner will amend subpart B by adding the name or description of the device, or both, to the list of banned devices. If the Commissioner decides to

revoke a proposed regulation making a device a banned device, a notice of termination of rulemaking proceedings and reasons therefor will be published in the FEDERAL REGISTER.

(e) The Commissioner may declare the special effective date provided by this section to be in effect after the publication of a proposed regulation under § 895.21(d), if, based on new information, or upon reconsideration of previously available information, the Commissioner makes the determination and provides the appropriate notices and an opportunity for a hearing in accordance with paragraphs (a) and (c) of this section.

(f) Those devices that have been named banned devices under § 895.30 and that have already been sold to the public may be subject to relabeling by the manufacturer, distributor, importer, or any other person(s) responsible for the labeling of the device or may be subject to the provisions of section 518(a) or (b) of the act.

[44 FR 29221, May 18, 1979, as amended at 57 FR 58405, Dec. 10, 1992; 80 FR 31300, June 2, 2015]

### Subpart B—Listing of Banned Devices

#### § 895.101 Prosthetic hair fibers.

Prosthetic hair fibers are devices intended for implantation into the human scalp to simulate natural hair or conceal baldness. Prosthetic hair fibers may consist of various materials; for example, synthetic fibers, such as modacrylic, polyacrylic, and polyester; and natural fibers, such as processed human hair. Excluded from the banned device are natural hair transplants, in which a person's hair and its surrounding tissue are surgically removed from one location on the person's scalp and then grafted onto another area of the person's scalp.

[48 FR 25136, June 3, 1983]

#### § 895.102 Powdered surgeon's glove.

(a) *Identification.* A powdered surgeon's glove is a device intended to be worn on the hands of operating room personnel to protect a surgical wound

**Food and Drug Administration, HHS**

**§ 898.13**

from contamination. A powdered surgeon's glove incorporates powder for purposes other than manufacturing.

(b) [Reserved]

[81 FR 91731, Dec. 19, 2016]

**§ 895.103 Powdered patient examination glove.**

(a) *Identification.* A powdered patient examination glove is a disposable device intended for medical purposes that is worn on the examiner's hand or finger to prevent contamination between patient and examiner. A powdered patient examination glove incorporates powder for purposes other than manufacturing.

(b) [Reserved]

[81 FR 91731, Dec. 19, 2016]

**§ 895.104 Absorbable powder for lubricating a surgeon's glove.**

Absorbable powder for lubricating a surgeon's glove is a powder made from cornstarch that meets the specifications for absorbable powder in the United States Pharmacopeia (U.S.P.) and that is intended to be used to lubricate the surgeon's hand before putting on a surgeon's glove. The device is absorbable through biological degradation.

[81 FR 91731, Dec. 19, 2016]

**§ 895.105 Electrical stimulation devices for self-injurious or aggressive behavior.**

Electrical stimulation devices for self-injurious or aggressive behavior are aversive conditioning devices that apply a noxious electrical stimulus to a person's skin to reduce or cease self-injurious or aggressive behavior.

[85 FR 13354, Mar. 6, 2020]

EFFECTIVE DATE NOTE: At 85 FR 13354, Mar. 6, 2020, § 895.105 was added, effective Apr. 6, 2020.

**PART 898—PERFORMANCE STANDARD FOR ELECTRODE LEAD WIRES AND PATIENT CABLES**

Sec.

898.11 Applicability.

898.12 Performance standard.

898.13 Compliance dates.

898.14 Exemptions and variances.

AUTHORITY: 21 U.S.C. 351, 352, 360c, 360d, 360gg–360ss, 371, 374; 42 U.S.C. 262, 264.

SOURCE: 62 FR 25497, May 9, 1997, unless otherwise noted.

**§ 898.11 Applicability.**

Electrode lead wires and patient cables intended for use with a medical device shall be subject to the performance standard set forth in § 898.12.

**§ 898.12 Performance standard.**

(a) Any connector in a cable or electrode lead wire having a conductive connection to a patient shall be constructed in such a manner as to comply with subclause 56.3(c) of the following standard:

International Electrotechnical Commission (IEC)  
601-1: Medical Electrical Equipment  
601-1 (1988) Part 1: General requirements for safety  
Amendment No. 1 (1991)  
Amendment No. 2 (1995).

(b) Compliance with the standard shall be determined by inspection and by applying the test requirements and test methods of subclause 56.3(c) of the standard set forth in paragraph (a) of this section.

**§ 898.13 Compliance dates.**

The dates for compliance with the standard set forth in § 898.12(a) shall be as follows:

(a) For electrode lead wires and patient cables used with, or intended for use with, the following devices, the date for which compliance is required is May 11, 1998:

LISTING OF DEVICES FOR WHICH COMPLIANCE IS REQUIRED EFFECTIVE  
May 11, 1998

Phase	Product code	21 CFR section	Class	Device name
1 .....	73 BZQ	868.2375	II	Monitor, Breathing Frequency.
1 .....	73 FLS	868.2375	II	Monitor (Apnea Detector), Ventilatory Effort.
1 .....	74 DPS	870.2340	II	Electrocardiograph.

LISTING OF DEVICES FOR WHICH COMPLIANCE IS REQUIRED EFFECTIVE—Continued  
 May 11, 1998

Phase	Product code	21 CFR section	Class	Device name
1 .....	74 DRG	870.2910	II	Transmitters and Receivers, Physiological Signal, Radio Frequency.
1 .....	74 DRT	870.2300	II	Monitor, Cardiac (including Cardiotachometer and Rate Alarm).
1 .....	74 DRX	870.2360	II	Electrode, Electrocardiograph.
1 .....	74 DSA	870.2900	II	Cable, Transducer and Electrode, Patient (including Connector).
1 .....	74 DSH	870.2800	II	Recorder, Magnetic Tape, Medical.
1 .....	74 DSI	870.1025	III	Detector and Alarm, Arrhythmia.
1 .....	74 DXH	870.2920	II	Transmitters and Receivers, Electrocardiograph, Telephone.

(b) For electrode lead wires and patient cables used with, or intended for use with, any other device, the date for which compliance is required is May 9, 2000.

**§ 898.14 Exemptions and variances.**

(a) A request for an exemption or variance shall be submitted in the form of a petition under §10.30 of this chapter and shall comply with the requirements set out therein. The petition shall also contain the following:

- (1) The name of the device, the class in which the device has been classified, and representative labeling showing the intended uses(s) of the device;
- (2) The reasons why compliance with the performance standard is unnecessary or unfeasible;

(3) A complete description of alternative steps that are available, or that the petitioner has already taken, to ensure that a patient will not be inadvertently connected to hazardous voltages via an unprotected patient cable or electrode lead wire for intended use with the device; and

(4) Other information justifying the exemption or variance.

(b) An exemption or variance is not effective until the agency approves the request under §10.30(e)(2)(i) of this chapter.

EFFECTIVE DATE NOTE: At 62 FR 25477, May 9, 1997, §898.14 was stayed pending Office of Management and Budget approval of information collection and recordkeeping requirements.

## SUBCHAPTER I—MAMMOGRAPHY QUALITY STANDARDS ACT

### PART 900—MAMMOGRAPHY

#### Subpart A—Accreditation

- Sec.  
900.1 Scope.  
900.2 Definitions.  
900.3 Application for approval as an accreditation body.  
900.4 Standards for accreditation bodies.  
900.5 Evaluation.  
900.6 Withdrawal of approval.  
900.7 Hearings.  
900.8-900.9 [Reserved]

#### Subpart B—Quality Standards and Certification

- 900.10 Applicability.  
900.11 Requirements for certification.  
900.12 Quality standards.  
900.13 Revocation of accreditation and revocation of accreditation body approval.  
900.14 Suspension or revocation of certificates.  
900.15 Appeals of adverse accreditation or reaccreditation decisions that preclude certification or recertification.  
900.16 Appeals of denials of certification.  
900.17 [Reserved]  
900.18 Alternative requirements for § 900.12 quality standards.

#### Subpart C—States as Certifiers

- 900.20 Scope.  
900.21 Application for approval as a certification agency.  
900.22 Standards for certification agencies.  
900.23 Evaluation.  
900.24 Withdrawal of approval.  
900.25 Hearings and appeals.

AUTHORITY: 21 U.S.C. 360i, 360nn, 374(e); 42 U.S.C. 263b.

SOURCE: 62 FR 55976, Oct. 28, 1997, unless otherwise noted. Republished and corrected at 62 FR 60614, Nov. 10, 1997.

#### Subpart A—Accreditation

##### § 900.1 Scope.

The regulations set forth in this part implement the Mammography Quality Standards Act (MQSA) (42 U.S.C. 263b). Subpart A of this part establishes procedures whereby an entity can apply to become a Food and Drug Administration (FDA)-approved accreditation body to accredit facilities to be eligible

to perform screening or diagnostic mammography services. Subpart A further establishes requirements and standards for accreditation bodies to ensure that all mammography facilities under the jurisdiction of the United States are adequately and consistently evaluated for compliance with national quality standards for mammography. Subpart B of this part establishes minimum national quality standards for mammography facilities to ensure safe, reliable, and accurate mammography. The regulations set forth in this part do not apply to facilities of the Department of Veterans Affairs.

##### § 900.2 Definitions.

The following definitions apply to subparts A, B, and C of this part:

(a) *Accreditation body* or *body* means an entity that has been approved by FDA under § 900.3(d) to accredit mammography facilities.

(b) *Action limits* or *action levels* means the minimum and maximum values of a quality assurance measurement that can be interpreted as representing acceptable performance with respect to the parameter being tested. Values less than the minimum or greater than the maximum action limit or level indicate that corrective action must be taken by the facility. Action limits or levels are also sometimes called control limits or levels.

(c) *Adverse event* means an undesirable experience associated with mammography activities within the scope of 42 U.S.C. 263b. Adverse events include but are not limited to:

- (1) Poor image quality;
- (2) Failure to send mammography reports within 30 days to the referring physician or in a timely manner to the self-referred patient; and
- (3) Use of personnel that do not meet the applicable requirements of § 900.12(a).

(d) *Air kerma* means kerma in a given mass of air. The unit used to measure the quantity of air kerma is the Gray (Gy). For X-rays with energies less

§ 900.2

21 CFR Ch. I (4–1–20 Edition)

than 300 kiloelectron volts (keV), 1 Gy = 100 rad. In air, 1 Gy of absorbed dose is delivered by 114 roentgens (R) of exposure.

(e) *Breast implant* means a prosthetic device implanted in the breast.

(f) *Calendar quarter* means any one of the following time periods during a given year: January 1 through March 31, April 1 through June 30, July 1 through September 30, or October 1 through December 31.

(g) *Category I* means medical educational activities that have been designated as Category I by the Accreditation Council for Continuing Medical Education (ACCME), the American Osteopathic Association (AOA), a state medical society, or an equivalent organization.

(h) *Certificate* means the certificate described in § 900.11(a).

(i) *Certification* means the process of approval of a facility by FDA or a certification agency to provide mammography services.

(j) *Clinical image* means a mammogram.

(k) *Consumer* means an individual who chooses to comment or complain in reference to a mammography examination, including the patient or representative of the patient (e.g., family member or referring physician).

(l) *Continuing education unit* or *continuing education credit* means one contact hour of training.

(m) *Contact hour* means an hour of training received through direct instruction.

(n) *Direct instruction* means:

(1) Face-to-face interaction between instructor(s) and student(s), as when the instructor provides a lecture, conducts demonstrations, or reviews student performance; or

(2) The administration and correction of student examinations by an instructor(s) with subsequent feedback to the student(s).

(o) *Direct supervision* means that:

(1) During joint interpretation of mammograms, the supervising interpreting physician reviews, discusses, and confirms the diagnosis of the physician being supervised and signs the resulting report before it is entered into the patient's records; or

(2) During the performance of a mammography examination or survey of the facility's equipment and quality assurance program, the supervisor is present to observe and correct, as needed, the performance of the individual being supervised who is performing the examination or conducting the survey.

(p) *Established operating level* means the value of a particular quality assurance parameter that has been established as an acceptable normal level by the facility's quality assurance program.

(q) *Facility* means a hospital, outpatient department, clinic, radiology practice, mobile unit, office of a physician, or other facility that conducts mammography activities, including the following: Operation of equipment to produce a mammogram, processing of the mammogram, initial interpretation of the mammogram, and maintaining viewing conditions for that interpretation. This term does not include a facility of the Department of Veterans Affairs.

(r) *First allowable time* means the earliest time a resident physician is eligible to take the diagnostic radiology boards from an FDA-designated certifying body. The "first allowable time" may vary with the certifying body.

(s) *FDA* means the Food and Drug Administration.

(t) *Interim regulations* means the regulations entitled "Requirements for Accrediting Bodies of Mammography Facilities" (58 FR 67558–67565) and "Quality Standards and Certification Requirements for Mammography Facilities" (58 FR 67565–67572), published by FDA on December 21, 1993, and amended on September 30, 1994 (59 FR 49808–49813). These regulations established the standards that had to be met by mammography facilities in order to lawfully operate between October 1, 1994, and April 28, 1999.

(u) *Interpreting physician* means a licensed physician who interprets mammograms and who meets the requirements set forth in § 900.12(a)(1).

(v) *Kerma* means the sum of the initial energies of all the charged particles liberated by uncharged ionizing particles in a material of given mass.

(w) *Laterality* means the designation of either the right or left breast.



(x) *Lead interpreting physician* means the interpreting physician assigned the general responsibility for ensuring that a facility's quality assurance program meets all of the requirements of § 900.12(d) through (f). The administrative title and other supervisory responsibilities of the individual, if any, are left to the discretion of the facility.

(y) *Mammogram* means a radiographic image produced through mammography.

(z) *Mammographic modality* means a technology, within the scope of 42 U.S.C. 263b, for radiography of the breast. Examples are screen-film mammography and xeromammography.

(aa) *Mammography* means radiography of the breast, but, for the purposes of this part, does not include:

(1) Radiography of the breast performed during invasive interventions for localization or biopsy procedures; or

(2) Radiography of the breast performed with an investigational mammography device as part of a scientific study conducted in accordance with FDA's investigational device exemption regulations in part 812 of this chapter.

(bb) *Mammography equipment evaluation* means an onsite assessment of mammography unit or image processor performance by a medical physicist for the purpose of making a preliminary determination as to whether the equipment meets all of the applicable standards in § 900.12(b) and (e).

(cc) *Mammography medical outcomes audit* means a systematic collection of mammography results and the comparison of those results with outcomes data.

(dd) *Mammography unit* or *units* means an assemblage of components for the production of X-rays for use during mammography, including, at a minimum: An X-ray generator, an X-ray control, a tube housing assembly, a beam limiting device, and the supporting structures for these components.

(ee) *Mean optical density* means the average of the optical densities measured using phantom thicknesses of 2, 4, and 6 centimeters with values of kilovolt peak (kVp) clinically appropriate for those thicknesses.

(ff) *Medical physicist* means a person trained in evaluating the performance of mammography equipment and facility quality assurance programs and who meets the qualifications for a medical physicist set forth in § 900.12(a)(3).

(gg) *MQSA* means the Mammography Quality Standards Act.

(hh) *Multi-reading* means two or more physicians, at least one of whom is an interpreting physician, interpreting the same mammogram.

(ii) *Patient* means any individual who undergoes a mammography evaluation in a facility, regardless of whether the person is referred by a physician or is self-referred.

(jj) *Phantom* means a test object used to simulate radiographic characteristics of compressed breast tissue and containing components that radiographically model aspects of breast disease and cancer.

(kk) *Phantom image* means a radiographic image of a phantom.

(ll) *Physical science* means physics, chemistry, radiation science (including medical physics and health physics), and engineering.

(mm) *Positive mammogram* means a mammogram that has an overall assessment of findings that are either "suspicious" or "highly suggestive of malignancy."

(nn) *Provisional certificate* means the provisional certificate described in § 900.11(b)(2).

(oo) *Qualified instructor* means an individual whose training and experience adequately prepares him or her to carry out specified training assignments. Interpreting physicians, radiologic technologists, or medical physicists who meet the requirements of § 900.12(a) would be considered qualified instructors in their respective areas of mammography. Other examples of individuals who may be qualified instructors for the purpose of providing training to meet the regulations of this part include, but are not limited to, instructors in a post-high school training institution and manufacturer's representatives.

(pp) *Quality control technologist* means an individual meeting the requirements of § 900.12(a)(2) who is responsible

### § 900.3

### 21 CFR Ch. I (4–1–20 Edition)

for those quality assurance responsibilities not assigned to the lead interpreting physician or to the medical physicist.

(qq) *Radiographic equipment* means X-ray equipment used for the production of static X-ray images.

(rr) *Radiologic technologist* means an individual specifically trained in the use of radiographic equipment and the positioning of patients for radiographic examinations and who meets the requirements set forth in § 900.12(a)(2).

(ss) *Serious adverse event* means an adverse event that may significantly compromise clinical outcomes, or an adverse event for which a facility fails to take appropriate corrective action in a timely manner.

(tt) *Serious complaint* means a report of a serious adverse event.

(uu) *Standard breast* means a 4.2 centimeter (cm) thick compressed breast consisting of 50 percent glandular and 50 percent adipose tissue.

(vv) *Survey* means an onsite physics consultation and evaluation of a facility quality assurance program performed by a medical physicist.

(ww) *Time cycle* means the film development time.

(xx) *Traceable to a national standard* means an instrument is calibrated at either the National Institute of Standards and Technology (NIST) or at a calibration laboratory that participates in a proficiency program with NIST at least once every 2 years and the results of the proficiency test conducted within 24 months of calibration show agreement within  $\pm 3$  percent of the national standard in the mammography energy range.

(yy) *Review physician* means a physician who, by meeting the requirements set out in § 900.4(c)(5), is qualified to review clinical images on behalf of the accreditation body.

(zz) *Certification agency* means a State that has been approved by FDA under § 900.21 to certify mammography facilities.

(aaa) *Performance indicators* mean the measures used to evaluate the certification agency's ability to conduct certification, inspection, and compliance activities.

(bbb) *Authorization* means obtaining approval from FDA to utilize new or

changed State regulations or procedures during the issuance, maintenance, and withdrawal of certificates by the certification agency.

[62 FR 55976, Oct. 28, 1997; 62 FR 60614, Nov. 10, 1997, as amended at 63 FR 56558, Oct. 22, 1998; 64 FR 32407, June 17, 1999; 67 FR 5467, Feb. 6, 2002]

#### § 900.3 Application for approval as an accreditation body.

(a) *Eligibility.* Private nonprofit organizations or State agencies capable of meeting the requirements of this subpart A may apply for approval as accreditation bodies.

(b) *Application for initial approval.* (1) An applicant seeking initial FDA approval as an accreditation body shall inform the Division of Mammography Quality Standards, Center for Devices and Radiological Health, Food and Drug Administration, 10903 New Hampshire Ave., Bldg. 66, Rm. 4445, Silver Spring, MD 20993, Attn: Program Management Branch, of its desire to be approved as an accreditation body and of its requested scope of authority.

(2) Following receipt of the request, FDA will provide the applicant with additional information to aid in submission of an application for approval as an accreditation body.

(3) The applicant shall furnish to FDA, at the address in § 900.3(b)(1), three copies of an application containing the following information, materials, and supporting documentation:

(i) Name, address, and phone number of the applicant and, if the applicant is not a State agency, evidence of nonprofit status (i.e., of fulfilling Internal Revenue Service requirements as a nonprofit organization);

(ii) Detailed description of the accreditation standards the applicant will require facilities to meet and a discussion substantiating their equivalence to FDA standards required under § 900.12;

(iii) Detailed description of the applicant's accreditation review and decisionmaking process, including:

(A) Procedures for performing accreditation and reaccreditation clinical image review in accordance with § 900.4(c), random clinical image reviews in accordance with § 900.4(f), and

additional mammography review in accordance with §900.12(j);

(B) Procedures for performing phantom image review;

(C) Procedures for assessing mammography equipment evaluations and surveys;

(D) Procedures for initiating and performing onsite visits to facilities;

(E) Procedures for assessing facility personnel qualifications;

(F) Copies of the accreditation application forms, guidelines, instructions, and other materials the applicant will send to facilities during the accreditation process, including an accreditation history form that requires each facility to provide a complete history of prior accreditation activities and a statement that all information and data submitted in the application is true and accurate, and that no material fact has been omitted;

(G) Policies and procedures for notifying facilities of deficiencies;

(H) Procedures for monitoring corrections of deficiencies by facilities;

(I) Policies and procedures for suspending or revoking a facility's accreditation;

(J) Policies and procedures that will ensure processing of accreditation applications and renewals within a timeframe approved by FDA and assurances that the body will adhere to such policies and procedures; and

(K) A description of the applicant's appeals process for facilities contesting adverse accreditation status decisions.

(iv) Education, experience, and training requirements for the applicant's professional staff, including reviewers of clinical or phantom images;

(v) Description of the applicant's electronic data management and analysis system with respect to accreditation review and decision processes and the applicant's ability to provide electronic data in a format compatible with FDA data systems;

(vi) Resource analysis that demonstrates that the applicant's staffing, funding, and other resources are adequate to perform the required accreditation activities;

(vii) Fee schedules with supporting cost data;

(viii) Statement of policies and procedures established to avoid conflicts

of interest or the appearance of conflicts of interest by the applicant's board members, commissioners, professional personnel (including reviewers of clinical and phantom images), consultants, administrative personnel, and other representatives of the applicant;

(ix) Statement of policies and procedures established to protect confidential information the applicant will collect or receive in its role as an accreditation body;

(x) Disclosure of any specific brand of imaging system or component, measuring device, software package, or other commercial product used in mammography that the applicant develops, sells, or distributes;

(xi) Description of the applicant's consumer complaint mechanism;

(xii) Satisfactory assurances that the applicant shall comply with the requirements of §900.4; and

(xiii) Any other information as may be required by FDA.

(c) *Application for renewal of approval.* An approved accreditation body that intends to continue to serve as an accreditation body beyond its current term shall apply to FDA for renewal or notify FDA of its plans not to apply for renewal in accordance with the following procedures and schedule:

(1) At least 9 months before the date of expiration of a body's approval, the body shall inform FDA, at the address given in §900.3(b)(1), of its intent to seek renewal.

(2) FDA will notify the applicant of the relevant information, materials, and supporting documentation required under §900.3(b)(3) that the applicant shall submit as part of the renewal procedure.

(3) At least 6 months before the date of expiration of a body's approval, the applicant shall furnish to FDA, at the address in §900.3(b)(1), three copies of a renewal application containing the information, materials, and supporting documentation requested by FDA in accordance with §900.3(c)(2).

(4) No later than July 28, 1998, any accreditation body approved under the interim regulations published in the FEDERAL REGISTER of December 21, 1993 (58 FR 67558), that desires to continue to serve as an accreditation body under

## § 900.4

## 21 CFR Ch. I (4–1–20 Edition)

the final regulations shall apply for renewal of approval in accordance with the procedures set forth in paragraphs (c)(1) through (c)(3) of this section.

(5) Any accreditation body that does not plan to renew its approval shall so notify FDA at the address given in paragraph (b)(1) of this section at least 9 months before the expiration of the body's term of approval.

(d) *Rulings on applications for initial and renewed approval.* (1) FDA will conduct a review and evaluation to determine whether the applicant substantially meets the applicable requirements of this subpart and whether the accreditation standards the applicant will require facilities to meet are substantially the same as the quality standards published under subpart B of this part.

(2) FDA will notify the applicant of any deficiencies in the application and request that those deficiencies be rectified within a specified time period. If the deficiencies are not rectified to FDA's satisfaction within the specified time period, the application for approval as an accreditation body may be rejected.

(3) FDA shall notify the applicant whether the application has been approved or denied. That notification shall list any conditions associated with approval or state the bases for any denial.

(4) The review of any application may include a meeting between FDA and representatives of the applicant at a time and location mutually acceptable to FDA and the applicant.

(5) FDA will advise the applicant of the circumstances under which a denied application may be resubmitted.

(6) If FDA does not reach a final decision on a renewal application in accordance with this paragraph before the expiration of an accreditation body's current term of approval, the approval will be deemed extended until the agency reaches a final decision on the application, unless an accreditation body does not rectify deficiencies in the application within the specified time period, as required in paragraph (d)(2) of this section.

(e) *Relinquishment of authority.* An accreditation body that decides to relinquish its accreditation authority be-

fore expiration of the body's term of approval shall submit a letter of such intent to FDA, at the address in § 900.3(b)(1), at least 9 months before relinquishing such authority.

(f) *Transfer of records.* An accreditation body that does not apply for renewal of accreditation body approval, is denied such approval by FDA, or relinquishes its accreditation authority and duties before expiration of its term of approval, shall:

(1) Transfer facility records and other related information as required by FDA to a location and according to a schedule approved by FDA.

(2) Notify, in a manner and time period approved by FDA, all facilities accredited or seeking accreditation by the body that the body will no longer have accreditation authority.

(g) *Scope of authority.* An accreditation body's term of approval is for a period not to exceed 7 years. FDA may limit the scope of accreditation authority.

[62 FR 55976, Oct. 28, 1997; 62 FR 60614, Nov. 10, 1997, as amended at 83 FR 13864, Apr. 2, 2018]

### § 900.4 Standards for accreditation bodies.

(a) *Code of conduct and general responsibilities.* The accreditation body shall accept the following responsibilities in order to ensure safe and accurate mammography at the facilities it accredits and shall perform these responsibilities in a manner that ensures the integrity and impartiality of accreditation body actions.

(1)(i) When an accreditation body receives or discovers information that suggests inadequate image quality, or upon request by FDA, the accreditation body shall review a facility's clinical images or other aspects of a facility's practice to assist FDA in determining whether or not the facility's practice poses a serious risk to human health. Such reviews are in addition to the evaluation an accreditation body performs as part of the initial accreditation or renewal process for facilities.

(ii) If review by the accreditation body demonstrates that a problem does exist with respect to image quality or other aspects of a facility's compliance with quality standards, or upon request

by FDA, the accreditation body shall require or monitor corrective actions, or suspend or revoke accreditation of the facility.

(2) The accreditation body shall inform FDA as soon as possible but in no case longer than 2 business days after becoming aware of equipment or practices that pose a serious risk to human health.

(3) The accreditation body shall establish and administer a quality assurance (QA) program that has been approved by FDA in accordance with § 900.3(d) or paragraph (a)(8) of this section. Such quality assurance program shall:

(i) Include requirements for clinical image review and phantom image review;

(ii) Ensure that clinical and phantom images are evaluated consistently and accurately; and

(iii) Specify the methods and frequency of training and evaluation for clinical and phantom image reviewers, and the bases and procedures for removal of such reviewers.

(4) The accreditation body shall establish measures that FDA has approved in accordance with § 900.3(d) or paragraph (a)(8) of this section to reduce the possibility of conflict of interest or facility bias on the part of individuals acting on the body's behalf. Such individuals who review clinical or phantom images under the provisions of paragraphs (c) and (d) of this section or who visit facilities under the provisions of paragraph (f) of this section shall not review clinical or phantom images from or visit a facility with which such individuals maintain a relationship, or when it would otherwise be a conflict of interest for them to do so, or when they have a bias in favor of or against the facility.

(5) The accreditation body may require specific equipment performance or design characteristics that FDA has approved. However, no accreditation body shall require, either explicitly or implicitly, the use of any specific brand of imaging system or component, measuring device, software package, or other commercial product as a condition for accreditation by the body, unless FDA determines that it is in the best interest of public health to do so.

(i) Any representation, actual or implied, either orally, in sales literature, or in any other form of representation, that the purchase or use of a particular product brand is required in order for any facility to be accredited or certified under § 900.11(b), is prohibited, unless FDA approves such representation.

(ii) Unless FDA has approved the exclusive use and promotion of a particular commercial product in accordance with this section, all products produced, distributed, or sold by an accreditation body or an organization that has a financial or other relationship with the accreditation body that may be a conflict of interest or have the appearance of a conflict of interest with the body's accreditation functions, shall bear a disclaimer stating that the purchase or use of such products is not required for accreditation or certification of any facility under § 900.11(b). Any representations about such products shall include a similar disclaimer.

(6) When an accreditation body denies accreditation to a facility, the accreditation body shall notify the facility in writing and explain the bases for its decision. The notification shall also describe the appeals process available from the accreditation body for the facility to contest the decision.

(7) No accreditation body may establish requirements that preclude facilities from being accredited under § 900.11(b) by any other accreditation body, or require accreditation by itself under MQSA if another accreditation body is available to a facility.

(8) The accreditation body shall obtain FDA authorization for any changes it proposes to make in any standards that FDA has previously accepted under § 900.3(d).

(9) An accreditation body shall establish procedures to protect confidential information it collects or receives in its role as an accreditation body.

(i) Nonpublic information collected from facilities for the purpose of carrying out accreditation body responsibilities shall not be used for any other purpose or disclosed, other than to FDA or its duly designated representatives, including State agencies, without the consent of the facility;

(ii) Nonpublic information that FDA or its duly designated representatives, including State agencies, share with the accreditation body concerning a facility that is accredited or undergoing accreditation by that body shall not be further disclosed except with the written permission of FDA.

(b) *Monitoring facility compliance with quality standards.* (1) The accreditation body shall require that each facility it accredits meet standards for the performance of quality mammography that are substantially the same as those in this subpart and in subpart B of this part.

(2) The accreditation body shall notify a facility regarding equipment, personnel, and other aspects of the facility's practice that do not meet such standards and advise the facility that such equipment, personnel, or other aspects of the practice should not be used by the facility for activities within the scope of part 900.

(3) The accreditation body shall specify the actions that facilities shall take to correct deficiencies in equipment, personnel, and other aspects of the practice to ensure facility compliance with applicable standards.

(4) If deficiencies cannot be corrected to ensure compliance with standards or if a facility is unwilling to take corrective actions, the accreditation body shall immediately so notify FDA, and shall suspend or revoke the facility's accreditation in accordance with the policies and procedures described under § 900.3(b)(3)(iii)(I).

(c) *Clinical image review for accreditation and reaccreditation*—(1) *Frequency of review.* The accreditation body shall review clinical images from each facility accredited by the body at least once every 3 years.

(2) *Requirements for clinical image attributes.* The accreditation body shall use the following attributes for all clinical image reviews, unless FDA has approved other attributes:

(i) *Positioning.* Sufficient breast tissue shall be imaged to ensure that cancers are not likely to be missed because of inadequate positioning.

(ii) *Compression.* Compression shall be applied in a manner that minimizes the potential obscuring effect of overlying breast tissue and motion artifact.

(iii) *Exposure level.* Exposure level shall be adequate to visualize breast structures. Images shall be neither underexposed nor overexposed.

(iv) *Contrast.* Image contrast shall permit differentiation of subtle tissue density differences.

(v) *Sharpness.* Margins of normal breast structures shall be distinct and not blurred.

(vi) *Noise.* Noise in the image shall not obscure breast structures or suggest the appearance of structures not actually present.

(vii) *Artifacts.* Artifacts due to lint, processing, scratches, and other factors external to the breast shall not obscure breast structures or suggest the appearance of structures not actually present.

(viii) *Examination identification.* Each image shall have the following information indicated on it in a permanent, legible, and unambiguous manner and placed so as not to obscure anatomic structures:

(A) Name of the patient and an additional patient identifier.

(B) Date of examination.

(C) *View and laterality.* This information shall be placed on the image in a position near the axilla. Standardized codes specified by the accreditation body and approved by FDA in accordance with § 900.3(d) or paragraph (a)(8) of this section shall be used to identify view and laterality.

(D) *Facility name and location.* At a minimum, the location shall include the city, State, and zip code of the facility.

(E) Technologist identification.

(F) Cassette/screen identification.

(G) Mammography unit identification, if there is more than one unit in the facility.

(3) *Scoring of clinical images.* Accreditation bodies shall establish and administer a system for scoring clinical images using all attributes specified in paragraphs (c)(2)(i) through (c)(2)(viii) of this section or an alternative system that FDA has approved in accordance with § 900.3(d) or paragraph (a)(8) of this section. The scoring system shall include an evaluation for each attribute.

(i) The accreditation body shall establish and employ criteria for acceptable and nonacceptable results for each

of the 8 attributes as well as an overall pass-fail system for clinical image review that has been approved by FDA in accordance with §900.3(d) or paragraph (a)(8) of this section.

(ii) All clinical images submitted by a facility to the accreditation body shall be reviewed independently by two or more review physicians.

(4) *Selection of clinical images for review.* Unless otherwise specified by FDA, the accreditation body shall require that for each mammography unit in the facility:

(i) The facility shall submit craniocaudal (CC) and mediolateral oblique (MLO) views from two mammographic examinations that the facility produced during a time period specified by the accreditation body;

(ii) Clinical images submitted from one such mammographic examination for each unit shall be of dense breasts (predominance of glandular tissue) and the other shall be of fat-replaced breasts (predominance of adipose tissue);

(iii) All clinical images submitted shall be images that the facility's interpreting physician(s) interpreted as negative or benign.

(iv) If the facility has no clinical images meeting the requirements in paragraphs (c)(4)(i) through (c)(4)(iii) of this section, it shall so notify the accreditation body, which shall specify alternative clinical image selection methods that do not compromise care of the patient.

(5) *Review physicians.* Accreditation bodies shall ensure that all of their review physicians:

(i) Meet the interpreting physician requirements specified in §900.12(a)(1) and meet such additional requirements as have been established by the accreditation body and approved by FDA;

(ii) Are trained and evaluated in the clinical image review process, for the types of clinical images to be evaluated by a review physician, by the accreditation body before designation as review physicians and periodically thereafter; and

(iii) Clearly document their findings and reasons for assigning a particular score to any clinical image and provide information to the facility for use in

improving the attributes for which significant deficiencies were identified.

(6) *Image management.* The accreditation body's QA program shall include a tracking system to ensure the security and return to the facility of all clinical images received and to ensure completion of all clinical image reviews by the body in a timely manner. The accreditation body shall return all clinical images to the facility within 60 days of their receipt by the body, with the following exceptions:

(i) If the clinical images are needed earlier by the facility for clinical purposes, the accreditation body shall cooperate with the facility to accommodate such needs.

(ii) If a review physician identifies a suspicious abnormality on an image submitted for clinical image review, the accreditation body shall ensure that this information is provided to the facility and that the clinical images are returned to the facility. Both shall occur no later than 10-business days after identification of the suspected abnormality.

(7) *Notification of unsatisfactory image quality.* If the accreditation body determines that the clinical images received from a facility are of unsatisfactory quality, the body shall notify the facility of the nature of the problem and its possible causes.

(d) *Phantom image review for accreditation and reaccreditation—(1) Frequency of review.* The accreditation body shall review phantom images from each facility accredited by the body at least once every 3 years.

(2) *Requirements for the phantom used.* The accreditation body shall require that each facility submit for review phantom images that the facility produced using a phantom and methods of use specified by the body and approved by FDA in accordance with §900.3(d) or paragraph (a)(8) of this section.

(3) *Scoring phantom images.* The accreditation body shall use a system for scoring phantom images that has been approved by FDA in accordance with §900.3(b) and (d) or paragraph (a)(8) of this section.

(4) *Phantom images selected for review.* For each mammography unit in the facility, the accreditation body shall require the facility to submit phantom

images that the facility produced during a time period specified by the body.

(5) *Phantom image reviewers.* Accreditation bodies shall ensure that all of their phantom image reviewers:

(i) Meet the requirements specified in § 900.12(a)(3) or alternative requirements established by the accreditation body and approved by FDA in accordance with § 900.3 or paragraph (a)(8) of this section;

(ii) Are trained and evaluated in the phantom image review process, for the types of phantom images to be evaluated by a phantom image reviewer, by the accreditation body before designation as phantom image reviewers and periodically thereafter; and

(iii) Clearly document their findings and reasons for assigning a particular score to any phantom image and provide information to the facility for use in improving its phantom image quality with regard to the significant deficiencies identified.

(6) *Image management.* The accreditation body's QA program shall include a tracking system to ensure the security of all phantom images received and to ensure completion of all phantom image reviews by the body in a timely manner. All phantom images that result in a failure of accreditation shall be returned to the facility.

(7) *Notification measures for unsatisfactory image quality.* If the accreditation body determines that the phantom images received from a facility are of unsatisfactory quality, the body shall notify the facility of the nature of the problem and its possible causes.

(e) *Reports of mammography equipment evaluation, surveys, and quality control.* The following requirements apply to all facility equipment covered by the provisions of subparts A and B:

(1) The accreditation body shall require every facility applying for accreditation to submit:

(i) With its initial accreditation application, a mammography equipment evaluation that was performed by a medical physicist no earlier than 6 months before the date of application for accreditation by the facility. Such evaluation shall demonstrate compliance of the facility's equipment with the requirements in § 900.12(e).

(ii) Prior to accreditation, a survey that was performed no earlier than 6 months before the date of application for accreditation by the facility. Such survey shall assess the facility's compliance with the facility standards referenced in paragraph (b) of this section.

(2) The accreditation body shall require that all facilities undergo an annual survey to ensure continued compliance with the standards referenced in paragraph (b) of this section and to provide continued oversight of facilities' quality control programs as they relate to such standards. The accreditation body shall require for all facilities that:

(i) Such surveys be conducted annually;

(ii) Facilities take reasonable steps to ensure that they receive reports of such surveys within 30 days of survey completion; and

(iii) Facilities submit the results of such surveys and any other information that the body may require to the body at least annually.

(3) The accreditation body shall review and analyze the information required in this section and use it to identify necessary corrective measures for facilities and to determine whether facilities should remain accredited by the body.

(f) *Accreditation body onsite visits and random clinical image reviews.* The accreditation body shall conduct onsite visits and random clinical image reviews of a sample of facilities to monitor and assess their compliance with standards established by the body for accreditation. The accreditation body shall submit annually to FDA, at the address given in § 900.3(b)(1), 3 copies of a summary report describing all facility assessments the body conducted under the provisions of this section for the year being reported.

(1) *Onsite visits—(i) Sample size.* Annually, each accreditation body shall visit at least 5 percent of the facilities it accredits. However, a minimum of 5 facilities shall be visited, and visits to no more than 50 facilities are required, unless problems identified in paragraph (f)(1)(i)(B) of this section indicate a need to visit more than 50 facilities.



(A) At least 50 percent of the facilities visited shall be selected randomly.

(B) Other facilities visited shall be selected based on problems identified through State or FDA inspections, serious complaints received from consumers or others, a previous history of noncompliance, or any other information in the possession of the accreditation body, inspectors, or FDA.

(C) Before, during, or after any facility visit, the accreditation body may require that the facility submit to the body for review clinical images, phantom images, or any other information relevant to applicable standards in this subpart and in subpart B of this part.

(ii) *Visit plan.* The accreditation body shall conduct facility onsite visits according to a visit plan that has been approved by FDA in accordance with §900.3(d) or paragraph (a)(8) of this section, unless otherwise directed by FDA in particular circumstances. At a minimum, such a plan shall provide for:

(A) Assessment of overall clinical image QA activities of the facility;

(B) Review of facility documentation to determine if appropriate mammography reports are sent to patients and physicians as required;

(C) Selection of a sample of clinical images for clinical image review by the accreditation body. Clinical images shall be selected in a manner specified by the accreditation body and approved by FDA that does not compromise care of the patient as a result of the absence of the selected images from the facility;

(D) Verification that the facility has a medical audit system in place and is correlating films and pathology reports for positive cases;

(E) Verification that personnel specified by the facility are the ones actually performing designated personnel functions;

(F) Verification that equipment specified by the facility is the equipment that is actually being used to perform designated equipment functions;

(G) Verification that a consumer complaint mechanism is in place and that the facility is following its procedures; and

(H) Review of all factors related to previously identified concerns or concerns identified during that visit.

(2) *Clinical image review for random sample of facilities—(i) Sample size.* In addition to conducting clinical image reviews for accreditation and re-accreditation for all facilities, the accreditation body shall conduct clinical image reviews annually for a randomly selected sample as specified by FDA, but to include at least 3 percent of the facilities the body accredits. Accreditation bodies may count toward this random sample requirement all facilities selected randomly for the onsite visits described in paragraph (f)(1)(i)(A) of this section. Accreditation bodies shall not count toward the random sample requirement any facilities described in paragraph (f)(1)(i)(B) of this section that were selected for a visit because of previously identified concerns.

(ii) *Random clinical image review.* In performing clinical image reviews of the random sample of facilities, accreditation bodies shall evaluate the same attributes as those in paragraph (c) of this section for review of clinical images for accreditation and reaccreditation.

(iii) Accreditation bodies should not schedule random clinical image reviews at facilities that have received notification of the need to begin the accreditation renewal process or that have completed the accreditation renewal process within the previous 6 months.

(iv) *Selection of the random sample of clinical images for clinical image review by the accreditation body.* Clinical images shall be selected in a manner, specified by the accreditation body and approved by FDA under §900.3(d) or paragraph (a)(8) of this section, that does not compromise care of the patient as a result of the absence of the selected images from the facility.

(g) *Consumer complaint mechanism.* The accreditation body shall develop and administer a written and documented system, including timeframes, for collecting and resolving serious consumer complaints that could not be resolved at a facility. Such system shall have been approved by FDA in accordance with §900.3(d) or paragraph (a)(8) of this section. Accordingly, all accreditation bodies shall:

## § 900.5

(1) Provide a mechanism for all facilities it accredits to file serious unresolved complaints with the accreditation body;

(2) Maintain a record of every serious unresolved complaint received by the body on all facilities it accredits for a period of at least 3 years from the date of receipt of each such complaint;

(h) *Reporting and recordkeeping.* All reports to FDA specified in paragraphs (h)(1) through (h)(4) of this section shall be prepared and submitted in a format and medium prescribed by FDA and shall be submitted to a location and according to a schedule specified by FDA. The accreditation body shall:

(1) Collect and submit to FDA the information required by 42 U.S.C. 263b(d) for each facility when the facility is initially accredited and at least annually when updated, in a manner and at a time specified by FDA.

(2) Accept applications containing the information required in 42 U.S.C. 263b(c)(2) for provisional certificates and in § 900.11(b)(3) for extension of provisional certificates, on behalf of FDA, and notify FDA of the receipt of such information;

(3) Submit to FDA the name, identifying information, and other information relevant to 42 U.S.C. 263b and specified by FDA for any facility for which the accreditation body denies, suspends, or revokes accreditation, and the reason(s) for such action;

(4) Submit to FDA an annual report summarizing all serious complaints received during the previous calendar year, their resolution status, and any actions taken in response to them;

(5) Provide to FDA other information relevant to 42 U.S.C. 263b and required by FDA about any facility accredited or undergoing accreditation by the body.

(i) *Fees.* Fees charged to facilities for accreditation shall be reasonable. Costs of accreditation body activities that are not related to accreditation functions under 42 U.S.C. 263b are not recoverable through fees established for accreditation.

(1) The accreditation body shall make public its fee structure, including those factors, if any, contributing to variations in fees for different facilities.

## 21 CFR Ch. I (4–1–20 Edition)

(2) At FDA's request, accreditation bodies shall provide financial records or other material to assist FDA in assessing the reasonableness of accreditation body fees. Such material shall be provided to FDA in a manner and time period specified by the agency.

[62 FR 55976, Oct. 28, 1997; 62 FR 60614, Nov. 10, 1997, as amended at 64 FR 32407, June 17, 1999]

### § 900.5 Evaluation.

FDA shall evaluate annually the performance of each accreditation body. Such evaluation shall include an assessment of the reports of FDA or State inspections of facilities accredited by the body as well as any additional information deemed relevant by FDA that has been provided by the accreditation body or other sources or has been required by FDA as part of its oversight initiatives. The evaluation shall include a determination of whether there are major deficiencies in the accreditation body's performance that, if not corrected, would warrant withdrawal of the approval of the accreditation body under the provisions of § 900.6.

### § 900.6 Withdrawal of approval.

If FDA determines, through the evaluation activities of § 900.5, or through other means, that an accreditation body is not in substantial compliance with this subpart, FDA may initiate the following actions:

(a) *Major deficiencies.* If FDA determines that an accreditation body has failed to perform a major accreditation function satisfactorily, has demonstrated willful disregard for public health, has violated the code of conduct, has committed fraud, or has submitted material false statements to the agency, FDA may withdraw its approval of that accreditation body.

(1) FDA shall notify the accreditation body of the agency's action and the grounds on which the approval was withdrawn.

(2) An accreditation body that has lost its approval shall notify facilities accredited or seeking accreditation by it that its approval has been withdrawn. Such notification shall be made within a time period and in a manner approved by FDA.

(b) *Minor deficiencies.* If FDA determines that an accreditation body has demonstrated deficiencies in performing accreditation functions and responsibilities that are less serious or more limited than the deficiencies in paragraph (a) of this section, FDA shall notify the body that it has a specified period of time to take particular corrective measures directed by FDA or to submit to FDA for approval the body's own plan of corrective action addressing the minor deficiencies. FDA may place the body on probationary status for a period of time determined by FDA, or may withdraw approval of the body as an accreditation body if corrective action is not taken.

(1) If FDA places an accreditation body on probationary status, the body shall notify all facilities accredited or seeking accreditation by it of its probationary status within a time period and in a manner approved by FDA.

(2) Probationary status shall remain in effect until such time as the body can demonstrate to the satisfaction of FDA that it has successfully implemented or is implementing the corrective action plan within the established schedule, and that the corrective actions have substantially eliminated all identified problems.

(3) If FDA determines that an accreditation body that has been placed on probationary status is not implementing corrective actions satisfactorily or within the established schedule, FDA may withdraw approval of the accreditation body. The accreditation body shall notify all facilities accredited or seeking accreditation by it of its loss of FDA approval, within a time period and in a manner approved by FDA.

(c) *Reapplication by accreditation bodies that have had their approval withdrawn.* (1) A former accreditation body that has had its approval withdrawn may submit a new application for approval if the body can provide information to FDA to establish that the problems that were grounds for withdrawal of approval have been resolved.

(2) If FDA determines that the new application demonstrates that the body satisfactorily has addressed the causes of its previous unacceptable perform-

ance, FDA may reinstate approval of the accreditation body.

(3) FDA may request additional information or establish additional conditions that must be met by a former accreditation body before FDA approves the reapplication.

(4) FDA may refuse to accept an application from a former accreditation body whose approval was withdrawn because of fraud or willful disregard of public health.

#### § 900.7 Hearings.

(a) Opportunities to challenge final adverse actions taken by FDA regarding approval or reapproval of accreditation bodies, withdrawal of approval of accreditation bodies, or rejection of a proposed fee for accreditation shall be communicated through notices of opportunity for informal hearings in accordance with part 16 of this chapter.

(b) A facility that has been denied accreditation is entitled to an appeals process from the accreditation body. The appeals process shall be specified in writing by the accreditation body and shall have been approved by FDA in accordance with § 900.3(d) or § 900.4(a)(8).

(c) A facility that cannot achieve satisfactory resolution of an adverse accreditation decision through the accreditation body's appeals process may appeal to FDA for reconsideration in accordance with § 900.15.

#### §§ 900.8–900.9 [Reserved]

### Subpart B—Quality Standards and Certification

#### § 900.10 Applicability.

The provisions of subpart B are applicable to all facilities under the regulatory jurisdiction of the United States that provide mammography services, with the exception of the Department of Veterans Affairs.

#### § 900.11 Requirements for certification.

(a) *General.* After October 1, 1994, a certificate issued by FDA is required

for lawful operation of all mammography facilities subject to the provisions of this subpart. To obtain a certificate from FDA, facilities are required to meet the quality standards in § 900.12 and to be accredited by an approved accreditation body or other entity as designated by FDA.

(b) *Application*—(1) *Certificates*. (i) In order to qualify for a certificate, a facility must apply to an FDA-approved accreditation body, or to another entity designated by FDA. The facility shall submit to such body or entity the information required in 42 U.S.C. 263b(d)(1).

(ii) Following the agency's receipt of the accreditation body's decision to accredit a facility, or an equivalent decision by another entity designated by FDA, the agency may issue a certificate to the facility, or renew an existing certificate, if the agency determines that the facility has satisfied the requirements for certification or recertification.

(2) *Provisional certificates*. (i) A new facility beginning operation after October 1, 1994, is eligible to apply for a provisional certificate. The provisional certificate will enable the facility to perform mammography and to obtain the clinical images needed to complete the accreditation process. To apply for and receive a provisional certificate, a facility must meet the requirements of 42 U.S.C. 263b(c)(4) and submit the necessary information to an approved accreditation body or other entity designated by FDA.

(ii) Following the agency's receipt of the accreditation body's decision that a facility has submitted the required information, FDA may issue a provisional certificate to a facility upon determination that the facility has satisfied the requirements of § 900.11(b)(2)(i). A provisional certificate shall be effective for up to 6 months from the date of issuance. A provisional certificate cannot be renewed, but a facility may apply for a 90-day extension of the provisional certificate.

(3) *Extension of provisional certificate*. (i) To apply for a 90-day extension to a provisional certificate, a facility shall submit to its accreditation body, or other entity designated by FDA, a statement of what the facility is doing

to obtain certification and evidence that there would be a significant adverse impact on access to mammography in the geographic area served if such facility did not obtain an extension.

(ii) The accreditation body shall forward the request, with its recommendation, to FDA within 2 business days after receipt.

(iii) FDA may issue a 90-day extension for a provisional certificate upon determination that the extension meets the criteria set forth in 42 U.S.C. 263b(c)(2).

(iv) There can be no renewal of a provisional certificate beyond the 90-day extension.

(c) *Reinstatement policy*. A previously certified facility that has allowed its certificate to expire, that has been refused a renewal of its certificate by FDA, or that has had its certificate suspended or revoked by FDA, may apply to have the certificate reinstated so that the facility may be considered to be a new facility and thereby be eligible for a provisional certificate.

(1) Unless prohibited from reinstatement under § 900.11(c)(4), a facility applying for reinstatement shall:

(i) Contact an FDA-approved accreditation body or other entity designated by FDA to determine the requirements for reapplication for accreditation;

(ii) Fully document its history as a previously provisionally certified or certified mammography facility, including the following information:

(A) Name and address of the facility under which it was previously provisionally certified or certified;

(B) Name of previous owner/lessor;

(C) FDA facility identification number assigned to the facility under its previous certification; and

(D) Expiration date of the most recent FDA provisional certificate or certificate; and

(iii) Justify application for reinstatement of accreditation by submitting to the accreditation body or other entity designated by FDA, a corrective action plan that details how the facility has corrected deficiencies that contributed to the lapse of, denial of renewal, or revocation of its certificate.

(2) FDA may issue a provisional certificate to the facility if:

(i) The accreditation body or other entity designated by FDA notifies the agency that the facility has adequately corrected, or is in the process of correcting, pertinent deficiencies; and

(ii) FDA determines that the facility has taken sufficient corrective action since the lapse of, denial of renewal, or revocation of its previous certificate.

(3) After receiving the provisional certificate, the facility may lawfully resume performing mammography services while completing the requirements for certification.

(4) If a facility's certificate was revoked on the basis of an act described in 41 U.S.C. 263b(i)(1), no person who owned or operated that facility at the time the act occurred may own or operate a mammography facility within 2 years of the date of revocation.

[62 FR 55976, Oct. 28, 1997; 62 FR 60614, Nov. 10, 1997, as amended at 83 FR 13864, Apr. 2, 2018]

#### § 900.12 Quality standards.

(a) *Personnel.* The following requirements apply to all personnel involved in any aspect of mammography, including the production, processing, and interpretation of mammograms and related quality assurance activities:

(1) *Interpreting physicians.* All physicians interpreting mammograms shall meet the following qualifications:

(i) *Initial qualifications.* Unless the exemption in paragraph (a)(1)(iii)(A) of this section applies, before beginning to interpret mammograms independently, the interpreting physician shall:

(A) Be licensed to practice medicine in a State;

(B)(1) Be certified in an appropriate specialty area by a body determined by FDA to have procedures and requirements adequate to ensure that physicians certified by the body are competent to interpret radiological procedures, including mammography; or

(2) Have had at least 3 months of documented formal training in the interpretation of mammograms and in topics related to mammography. The training shall include instruction in radiation physics, including radiation physics specific to mammography, radiation effects, and radiation protection. The mammographic interpretation component shall be under the di-

rect supervision of a physician who meets the requirements of paragraph (a)(1) of this section;

(C) Have a minimum of 60 hours of documented medical education in mammography, which shall include: instruction in the interpretation of mammograms and education in basic breast anatomy, pathology, physiology, technical aspects of mammography, and quality assurance and quality control in mammography. All 60 of these hours shall be category I and at least 15 of the category I hours shall have been acquired within the 3 years immediately prior to the date that the physician qualifies as an interpreting physician. Hours spent in residency specifically devoted to mammography will be considered as equivalent to Category I continuing medical education credits and will be accepted if documented in writing by the appropriate representative of the training institution; and

(D) Unless the exemption in paragraph (a)(1)(iii)(B) of this section applies, have interpreted or multi-read at least 240 mammographic examinations within the 6-month period immediately prior to the date that the physician qualifies as an interpreting physician. This interpretation or multi-reading shall be under the direct supervision of an interpreting physician.

(ii) *Continuing experience and education.* All interpreting physicians shall maintain their qualifications by meeting the following requirements:

(A) Following the second anniversary date of the end of the calendar quarter in which the requirements of paragraph (a)(1)(i) of this section were completed, the interpreting physician shall have interpreted or multi-read at least 960 mammographic examinations during the 24 months immediately preceding the date of the facility's annual MQSA inspection or the last day of the calendar quarter preceding the inspection or any date in-between the two. The facility will choose one of these dates to determine the 24-month period.

(B) Following the third anniversary date of the end of the calendar quarter in which the requirements of paragraph (a)(1)(i) of this section were completed, the interpreting physician shall have taught or completed at least 15 category I continuing medical education

units in mammography during the 36 months immediately preceding the date of the facility's annual MQSA inspection or the last day of the calendar quarter preceding the inspection or any date in between the two. The facility will choose one of these dates to determine the 36-month period. This training shall include at least six category I continuing medical education credits in each mammographic modality used by the interpreting physician in his or her practice; and

(C) Before an interpreting physician may begin independently interpreting mammograms produced by a new mammographic modality, that is, a mammographic modality in which the physician has not previously been trained, the interpreting physician shall have at least 8 hours of training in the new mammographic modality.

(D) Units earned through teaching a specific course can be counted only once towards the 15 required by paragraph (a)(1)(ii)(B) of this section, even if the course is taught multiple times during the previous 36 months.

(iii) *Exemptions.* (A) Those physicians who qualified as interpreting physicians under paragraph (a)(1) of this section of FDA's interim regulations prior to April 28, 1999, are considered to have met the initial requirements of paragraph (a)(1)(i) of this section. They may continue to interpret mammograms provided they continue to meet the licensure requirement of paragraph (a)(1)(i)(A) of this section and the continuing experience and education requirements of paragraph (a)(1)(ii) of this section.

(B) Physicians who have interpreted or multi-read at least 240 mammographic examinations under the direct supervision of an interpreting physician in any 6-month period during the last 2 years of a diagnostic radiology residency and who become appropriately board certified at the first allowable time, as defined by an eligible certifying body, are otherwise exempt from paragraph (a)(1)(i)(D) of this section.

(iv) *Reestablishing qualifications.* Interpreting physicians who fail to maintain the required continuing experience or continuing education requirements shall reestablish their qualifica-

tions before resuming the independent interpretation of mammograms, as follows:

(A) Interpreting physicians who fail to meet the continuing experience requirements of paragraph (a)(1)(ii)(A) of this section shall:

(1) Interpret or multi-read at least 240 mammographic examinations under the direct supervision of an interpreting physician, or

(2) Interpret or multi-read a sufficient number of mammographic examinations, under the direct supervision of an interpreting physician, to bring the physician's total up to 960 examinations for the prior 24 months, whichever is less.

(3) The interpretations required under paragraph (a)(1)(iv)(A)(1) or (a)(1)(iv)(A)(2) of this section shall be done within the 6 months immediately prior to resuming independent interpretation.

(B) Interpreting physicians who fail to meet the continuing education requirements of paragraph (a)(1)(ii)(B) of this section shall obtain a sufficient number of additional category I continuing medical education credits in mammography to bring their total up to the required 15 credits in the previous 36 months before resuming independent interpretation.

(2) *Radiologic technologists.* All mammographic examinations shall be performed by radiologic technologists who meet the following general requirements, mammography requirements, and continuing education and experience requirements:

(i) *General requirements.* (A) Be licensed to perform general radiographic procedures in a State; or

(B) Have general certification from one of the bodies determined by FDA to have procedures and requirements adequate to ensure that radiologic technologists certified by the body are competent to perform radiologic examinations; and

(ii) *Mammography requirements.* Have, prior to April 28, 1999, qualified as a radiologic technologist under paragraph (a)(2) of this section of FDA's interim regulations of December 21, 1993, or completed at least 40 contact hours of documented training specific to mammography under the supervision

of a qualified instructor. The hours of documented training shall include, but not necessarily be limited to:

(A) Training in breast anatomy and physiology, positioning and compression, quality assurance/quality control techniques, imaging of patients with breast implants;

(B) The performance of a minimum of 25 examinations under the direct supervision of an individual qualified under paragraph (a)(2) of this section; and

(C) At least 8 hours of training in each mammography modality to be used by the technologist in performing mammography exams; and

(iii) *Continuing education requirements.* (A) Following the third anniversary date of the end of the calendar quarter in which the requirements of paragraphs (a)(2)(i) and (a)(2)(ii) of this section were completed, the radiologic technologist shall have taught or completed at least 15 continuing education units in mammography during the 36 months immediately preceding the date of the facility's annual MQSA inspection or the last day of the calendar quarter preceding the inspection or any date in between the two. The facility will choose one of these dates to determine the 36-month period.

(B) Units earned through teaching a specific course can be counted only once towards the 15 required in paragraph (a)(2)(iii)(A) of this section, even if the course is taught multiple times during the previous 36 months.

(C) At least six of the continuing education units required in paragraph (a)(2)(iii)(A) of this section shall be related to each mammographic modality used by the technologist.

(D) *Requalification.* Radiologic technologists who fail to meet the continuing education requirements of paragraph (a)(2)(iii)(A) of this section shall obtain a sufficient number of continuing education units in mammography to bring their total up to at least 15 in the previous 3 years, at least 6 of which shall be related to each modality used by the technologist in mammography. The technologist may not resume performing unsupervised mammography examinations until the continuing education requirements are completed.

(E) Before a radiologic technologist may begin independently performing mammographic examinations using a mammographic modality other than one of those for which the technologist received training under paragraph (a)(2)(ii)(C) of this section, the technologist shall have at least 8 hours of continuing education units in the new modality.

(iv) *Continuing experience requirements.* (A) Following the second anniversary date of the end of the calendar quarter in which the requirements of paragraphs (a)(2)(i) and (a)(2)(ii) of this section were completed or of April 28, 1999, whichever is later, the radiologic technologist shall have performed a minimum of 200 mammography examinations during the 24 months immediately preceding the date of the facility's annual inspection or the last day of the calendar quarter preceding the inspection or any date in between the two. The facility will choose one of these dates to determine the 24-month period.

(B) *Requalification.* Radiologic technologists who fail to meet the continuing experience requirements of paragraph (a)(2)(iv)(A) of this section shall perform a minimum of 25 mammography examinations under the direct supervision of a qualified radiologic technologist, before resuming the performance of unsupervised mammography examinations.

(3) *Medical physicists.* All medical physicists conducting surveys of mammography facilities and providing oversight of the facility quality assurance program under paragraph (e) of this section shall meet the following:

(i) *Initial qualifications.* (A) Be State licensed or approved or have certification in an appropriate specialty area by one of the bodies determined by FDA to have procedures and requirements to ensure that medical physicists certified by the body are competent to perform physics survey; and

(B)(1) Have a masters degree or higher in a physical science from an accredited institution, with no less than 20 semester hours or equivalent (e.g., 30 quarter hours) of college undergraduate or graduate level physics;

(2) Have 20 contact hours of documented specialized training in conducting surveys of mammography facilities; and

(3) Have the experience of conducting surveys of at least 1 mammography facility and a total of at least 10 mammography units. No more than one survey of a specific unit within a period of 60 days can be counted towards the total mammography unit survey requirement. After April 28, 1999, experience conducting surveys must be acquired under the direct supervision of a medical physicist who meets all the requirements of paragraphs (a)(3)(i) and (a)(3)(iii) of this section; or

(ii) *Alternative initial qualifications.*

(A) Have qualified as a medical physicist under paragraph (a)(3) of this section of FDA's interim regulations and retained that qualification by maintenance of the active status of any licensure, approval, or certification required under the interim regulations; and

(B) Prior to the April 28, 1999, have:

(1) A bachelor's degree or higher in a physical science from an accredited institution with no less than 10 semester hours or equivalent of college undergraduate or graduate level physics,

(2) Forty contact hours of documented specialized training in conducting surveys of mammography facilities and,

(3) Have the experience of conducting surveys of at least 1 mammography facility and a total of at least 20 mammography units. No more than one survey of a specific unit within a period of 60 days can be counted towards the total mammography unit survey requirement. The training and experience requirements must be met after fulfilling the degree requirement.

(iii) *Continuing qualifications.* (A) Continuing education. Following the third anniversary date of the end of the calendar quarter in which the requirements of paragraph (a)(3)(i) or (a)(3)(ii) of this section were completed, the medical physicist shall have taught or completed at least 15 continuing education units in mammography during the 36 months immediately preceding the date of the facility's annual inspection or the last day of the calendar quarter preceding the inspection or any

date in between the two. The facility shall choose one of these dates to determine the 36-month period. This continuing education shall include hours of training appropriate to each mammographic modality evaluated by the medical physicist during his or her surveys or oversight of quality assurance programs. Units earned through teaching a specific course can be counted only once towards the required 15 units in a 36-month period, even if the course is taught multiple times during the 36 months.

(B) *Continuing experience.* Following the second anniversary date of the end of the calendar quarter in which the requirements of paragraphs (a)(3)(i) and (a)(3)(ii) of this section were completed or of April 28, 1999, whichever is later, the medical physicist shall have surveyed at least two mammography facilities and a total of at least six mammography units during the 24 months immediately preceding the date of the facility's annual MQSA inspection or the last day of the calendar quarter preceding the inspection or any date in between the two. The facility shall choose one of these dates to determine the 24-month period. No more than one survey of a specific facility within a 10-month period or a specific unit within a period of 60 days can be counted towards this requirement.

(C) Before a medical physicist may begin independently performing mammographic surveys of a new mammographic modality, that is, a mammographic modality other than one for which the physicist received training to qualify under paragraph (a)(3)(i) or (a)(3)(ii) of this section, the physicist must receive at least 8 hours of training in surveying units of the new mammographic modality.

(iv) *Reestablishing qualifications.* Medical physicists who fail to maintain the required continuing qualifications of paragraph (a)(3)(iii) of this section may not perform the MQSA surveys without the supervision of a qualified medical physicist. Before independently surveying another facility, medical physicists must reestablish their qualifications, as follows:

(A) Medical physicists who fail to meet the continuing educational requirements of paragraph (a)(3)(iii)(A) of



this section shall obtain a sufficient number of continuing education units to bring their total units up to the required 15 in the previous 3 years.

(B) Medical physicists who fail to meet the continuing experience requirement of paragraph (a)(3)(iii)(B) of this section shall complete a sufficient number of surveys under the direct supervision of a medical physicist who meets the qualifications of paragraphs (a)(3)(i) and (a)(3)(iii) of this section to bring their total surveys up to the required two facilities and six units in the previous 24 months. No more than one survey of a specific unit within a period of 60 days can be counted towards the total mammography unit survey requirement.

(4) *Retention of personnel records.* Facilities shall maintain records to document the qualifications of all personnel who worked at the facility as interpreting physicians, radiologic technologists, or medical physicists. These records must be available for review by the MQSA inspectors. Records of personnel no longer employed by the facility should not be discarded until the next annual inspection has been completed and FDA has determined that the facility is in compliance with the MQSA personnel requirements.

(b) *Equipment.* Regulations published under §§1020.30, 1020.31, and 900.12(e) of this chapter that are relevant to equipment performance should also be consulted for a more complete understanding of the equipment performance requirements.

(1) *Prohibited equipment.* Radiographic equipment designed for general purpose or special nonmammography procedures shall not be used for mammography. This prohibition includes systems that have been modified or equipped with special attachments for mammography. This requirement supersedes the implied acceptance of such systems in §1020.31(f)(3) of this chapter.

(2) *General.* All radiographic equipment used for mammography shall be specifically designed for mammography and shall be certified pursuant to §1010.2 of this chapter as meeting the applicable requirements of §§1020.30 and 1020.31 of this chapter in effect at the date of manufacture.

(3) *Motion of tube-image receptor assembly.* (i) The assembly shall be capable of being fixed in any position where it is designed to operate. Once fixed in any such position, it shall not undergo unintended motion.

(ii) The mechanism ensuring compliance with paragraph (b)(3)(i) of this section shall not fail in the event of power interruption.

(4) *Image receptor sizes.* (i) Systems using screen-film image receptors shall provide, at a minimum, for operation with image receptors of 18 × 24 centimeters (cm) and 24 × 30 cm.

(ii) Systems using screen-film image receptors shall be equipped with moving grids matched to all image receptor sizes provided.

(iii) Systems used for magnification procedures shall be capable of operation with the grid removed from between the source and image receptor.

(5) *Light fields.* For any mammography system with a light beam that passes through the x-ray beam-limiting device, the light shall provide an average illumination of not less than 160 lux (15 foot candles) at 100 cm or the maximum source-image receptor distance (SID), whichever is less.

(6) *Magnification.* (i) Systems used to perform noninterventional problem solving procedures shall have radiographic magnification capability available for use by the operator.

(ii) Systems used for magnification procedures shall provide, at a minimum, at least one magnification value within the range of 1.4 to 2.0.

(7) *Focal spot selection.* (i) When more than one focal spot is provided, the system shall indicate, prior to exposure, which focal spot is selected.

(ii) When more than one target material is provided, the system shall indicate, prior to exposure, the preselected target material.

(iii) When the target material and/or focal spot is selected by a system algorithm that is based on the exposure or on a test exposure, the system shall display, after the exposure, the target material and/or focal spot actually used during the exposure.

(8) *Compression.* All mammography systems shall incorporate a compression device.

(i) *Application of compression.* Effective October 28, 2002, each system shall provide:

(A) An initial power-driven compression activated by hands-free controls operable from both sides of the patient; and

(B) Fine adjustment compression controls operable from both sides of the patient.

(ii) *Compression paddle.* (A) Systems shall be equipped with different sized compression paddles that match the sizes of all full-field image receptors provided for the system. Compression paddles for special purposes, including those smaller than the full size of the image receptor (for “spot compression”) may be provided. Such compression paddles for special purposes are not subject to the requirements of paragraphs (b)(8)(ii)(D) and (b)(8)(ii)(E) of this section.

(B) Except as provided in paragraph (b)(8)(ii)(C) of this section, the compression paddle shall be flat and parallel to the breast support table and shall not deflect from parallel by more than 1.0 cm at any point on the surface of the compression paddle when compression is applied.

(C) Equipment intended by the manufacturer’s design to not be flat and parallel to the breast support table during compression shall meet the manufacturer’s design specifications and maintenance requirements.

(D) The chest wall edge of the compression paddle shall be straight and parallel to the edge of the image receptor.

(E) The chest wall edge may be bent upward to allow for patient comfort but shall not appear on the image.

(9) *Technique factor selection and display.* (i) Manual selection of milliampere seconds (mAs) or at least one of its component parts (milliapere (mA) and/or time) shall be available.

(ii) The technique factors (peak tube potential in kilovolt (kV) and either tube current in mA and exposure time in seconds or the product of tube current and exposure time in mAs) to be used during an exposure shall be indicated before the exposure begins, except when automatic exposure controls (AEC) are used, in which case the tech-

nique factors that are set prior to the exposure shall be indicated.

(iii) Following AEC mode use, the system shall indicate the actual kilovoltage peak (kVp) and mAs used during the exposure. The mAs may be displayed as mA and time.

(10) *Automatic exposure control.* (i) Each screen-film system shall provide an AEC mode that is operable in all combinations of equipment configuration provided, e.g., grid, nongrid; magnification, nonmagnification; and various target-filter combinations.

(ii) The positioning or selection of the detector shall permit flexibility in the placement of the detector under the target tissue.

(A) The size and available positions of the detector shall be clearly indicated at the X-ray input surface of the breast compression paddle.

(B) The selected position of the detector shall be clearly indicated.

(iii) The system shall provide means for the operator to vary the selected optical density from the normal (zero) setting.

(11) *X-ray film.* The facility shall use X-ray film for mammography that has been designated by the film manufacturer as appropriate for mammography.

(12) *Intensifying screens.* The facility shall use intensifying screens for mammography that have been designated by the screen manufacturer as appropriate for mammography and shall use film that is matched to the screen’s spectral output as specified by the manufacturer.

(13) *Film processing solutions.* For processing mammography films, the facility shall use chemical solutions that are capable of developing the films used by the facility in a manner equivalent to the minimum requirements specified by the film manufacturer.

(14) *Lighting.* The facility shall make special lights for film illumination, i.e., hot-lights, capable of producing light levels greater than that provided by the view box, available to the interpreting physicians.

(15) *Film masking devices.* Facilities shall ensure that film masking devices that can limit the illuminated area to a region equal to or smaller than the

exposed portion of the film are available to all interpreting physicians interpreting for the facility.

(c) *Medical records and mammography reports*—(1) *Contents and terminology.* Each facility shall prepare a written report of the results of each mammography examination performed under its certificate. The mammography report shall include the following information:

(i) The name of the patient and an additional patient identifier;

(ii) Date of examination;

(iii) The name of the interpreting physician who interpreted the mammogram;

(iv) Overall final assessment of findings, classified in one of the following categories:

(A) “Negative:” Nothing to comment upon (if the interpreting physician is aware of clinical findings or symptoms, despite the negative assessment, these shall be explained);

(B) “Benign:” Also a negative assessment;

(C) “Probably Benign:” Finding(s) has a high probability of being benign;

(D) “Suspicious:” Finding(s) without all the characteristic morphology of breast cancer but indicating a definite probability of being malignant;

(E) “Highly suggestive of malignancy:” Finding(s) has a high probability of being malignant;

(v) In cases where no final assessment category can be assigned due to incomplete work-up, “Incomplete; Need additional imaging evaluation” shall be assigned as an assessment and reasons why no assessment can be made shall be stated by the interpreting physician; and

(vi) Recommendations made to the health care provider about what additional actions, if any, should be taken. All clinical questions raised by the referring health care provider shall be addressed in the report to the extent possible, even if the assessment is negative or benign.

(2) *Communication of mammography results to the patients.* Each facility shall send each patient a summary of the mammography report written in lay terms within 30 days of the mammographic examination. If assessments are “Suspicious” or “Highly suggestive

of malignancy,” the facility shall make reasonable attempts to ensure that the results are communicated to the patient as soon as possible.

(i) Patients who do not name a health care provider to receive the mammography report shall be sent the report described in paragraph (c)(1) of this section within 30 days, in addition to the written notification of results in lay terms.

(ii) Each facility that accepts patients who do not have a health care provider shall maintain a system for referring such patients to a health care provider when clinically indicated.

(3) *Communication of mammography results to health care providers.* When the patient has a referring health care provider or the patient has named a health care provider, the facility shall:

(i) Provide a written report of the mammography examination, including the items listed in paragraph (c)(1) of this section, to that health care provider as soon as possible, but no later than 30 days from the date of the mammography examination; and

(ii) If the assessment is “Suspicious” or “Highly suggestive of malignancy,” make reasonable attempts to communicate with the health care provider as soon as possible, or if the health care provider is unavailable, to a responsible designee of the health care provider.

(4) *Recordkeeping.* Each facility that performs mammograms:

(i) Shall (except as provided in paragraph (c)(4)(ii) of this section) maintain mammography films and reports in a permanent medical record of the patient for a period of not less than 5 years, or not less than 10 years if no additional mammograms of the patient are performed at the facility, or a longer period if mandated by State or local law; and

(ii) Shall upon request by, or on behalf of, the patient, permanently or temporarily transfer the original mammograms and copies of the patient’s reports to a medical institution, or to a physician or health care provider of the patient, or to the patient directly;

(iii) Any fee charged to the patients for providing the services in paragraph (c)(4)(ii) of this section shall not exceed

the documented costs associated with this service.

(5) *Mammographic image identification.* Each mammographic image shall have the following information indicated on it in a permanent, legible, and unambiguous manner and placed so as not to obscure anatomic structures:

(i) Name of patient and an additional patient identifier.

(ii) Date of examination.

(iii) *View and laterality.* This information shall be placed on the image in a position near the axilla. Standardized codes specified by the accreditation body and approved by FDA in accordance with § 900.3(b) or § 900.4(a)(8) shall be used to identify view and laterality.

(iv) *Facility name and location.* At a minimum, the location shall include the city, State, and zip code of the facility.

(v) Technologist identification.

(vi) Cassette/screen identification.

(vii) Mammography unit identification, if there is more than one unit in the facility.

(d) *Quality assurance—general.* Each facility shall establish and maintain a quality assurance program to ensure the safety, reliability, clarity, and accuracy of mammography services performed at the facility.

(1) *Responsible individuals.* Responsibility for the quality assurance program and for each of its elements shall be assigned to individuals who are qualified for their assignments and who shall be allowed adequate time to perform these duties.

(i) *Lead interpreting physician.* The facility shall identify a lead interpreting physician who shall have the general responsibility of ensuring that the quality assurance program meets all requirements of paragraphs (d) through (f) of this section. No other individual shall be assigned or shall retain responsibility for quality assurance tasks unless the lead interpreting physician has determined that the individual's qualifications for, and performance of, the assignment are adequate.

(ii) *Interpreting physicians.* All interpreting physicians interpreting mammograms for the facility shall:

(A) Follow the facility procedures for corrective action when the images they

are asked to interpret are of poor quality, and

(B) Participate in the facility's medical outcomes audit program.

(iii) *Medical physicist.* Each facility shall have the services of a medical physicist available to survey mammography equipment and oversee the equipment-related quality assurance practices of the facility. At a minimum, the medical physicist(s) shall be responsible for performing the surveys and mammography equipment evaluations and providing the facility with the reports described in paragraphs (e)(9) and (e)(10) of this section.

(iv) *Quality control technologist.* Responsibility for all individual tasks within the quality assurance program not assigned to the lead interpreting physician or the medical physicist shall be assigned to a quality control technologist(s). The tasks are to be performed by the quality control technologist or by other personnel qualified to perform the tasks. When other personnel are utilized for these tasks, the quality control technologist shall ensure that the tasks are completed in such a way as to meet the requirements of paragraph (e) of this section.

(2) *Quality assurance records.* The lead interpreting physician, quality control technologist, and medical physicist shall ensure that records concerning mammography technique and procedures, quality control (including monitoring data, problems detected by analysis of that data, corrective actions, and the effectiveness of the correction actions), safety, protection, and employee qualifications to meet assigned quality assurance tasks are properly maintained and updated. These quality control records shall be kept for each test specified in paragraphs (e) and (f) of this section until the next annual inspection has been completed and FDA has determined that the facility is in compliance with the quality assurance requirements or until the test has been performed two additional times at the required frequency, whichever is longer.

(e) *Quality assurance—equipment—(1) Daily quality control tests.* Film processors used to develop mammograms shall be adjusted and maintained to

meet the technical development specifications for the mammography film in use. A processor performance test shall be performed on each day that clinical films are processed before any clinical films are processed that day. The test shall include an assessment of base plus fog density, mid-density, and density difference, using the mammography film used clinically at the facility.

(i) The base plus fog density shall be within + 0.03 of the established operating level.

(ii) The mid-density shall be within  $\pm 0.15$  of the established operating level.

(iii) The density difference shall be within  $\pm 0.15$  of the established operating level.

(2) *Weekly quality control tests.* Facilities with screen-film systems shall perform an image quality evaluation test, using an FDA-approved phantom, at least weekly.

(i) The optical density of the film at the center of an image of a standard FDA-accepted phantom shall be at least 1.20 when exposed under a typical clinical condition.

(ii) The optical density of the film at the center of the phantom image shall not change by more than  $\pm 0.20$  from the established operating level.

(iii) The phantom image shall achieve at least the minimum score established by the accreditation body and accepted by FDA in accordance with § 900.3(d) or § 900.4(a)(8).

(iv) The density difference between the background of the phantom and an added test object, used to assess image contrast, shall be measured and shall not vary by more than  $\pm 0.05$  from the established operating level.

(3) *Quarterly quality control tests.* Facilities with screen-film systems shall perform the following quality control tests at least quarterly:

(i) *Fixer retention in film.* The residual fixer shall be no more than 5 micrograms per square cm.

(ii) *Repeat analysis.* If the total repeat or reject rate changes from the previously determined rate by more than 2.0 percent of the total films included in the analysis, the reason(s) for the change shall be determined. Any corrective actions shall be recorded and

the results of these corrective actions shall be assessed.

(4) *Semiannual quality control tests.* Facilities with screen-film systems shall perform the following quality control tests at least semiannually:

(i) *Darkroom fog.* The optical density attributable to darkroom fog shall not exceed 0.05 when a mammography film of the type used in the facility, which has a mid-density of no less than 1.2 OD, is exposed to typical darkroom conditions for 2 minutes while such film is placed on the counter top emulsion side up. If the darkroom has a safelight used for mammography film, it shall be on during this test.

(ii) *Screen-film contact.* Testing for screen-film contact shall be conducted using 40 mesh copper screen. All cassettes used in the facility for mammography shall be tested.

(iii) *Compression device performance.* (A) A compression force of at least 111 newtons (25 pounds) shall be provided.

(B) Effective October 28, 2002, the maximum compression force for the initial power drive shall be between 111 newtons (25 pounds) and 200 newtons (45 pounds).

(5) *Annual quality control tests.* Facilities with screen-film systems shall perform the following quality control tests at least annually:

(i) *Automatic exposure control performance.* (A) The AEC shall be capable of maintaining film optical density within  $\pm 0.30$  of the mean optical density when thickness of a homogeneous material is varied over a range of 2 to 6 cm and the kVp is varied appropriately for such thicknesses over the kVp range used clinically in the facility. If this requirement cannot be met, a technique chart shall be developed showing appropriate techniques (kVp and density control settings) for different breast thicknesses and compositions that must be used so that optical densities within  $\pm 0.30$  of the average under phototimed conditions can be produced.

(B) After October 28, 2002, the AEC shall be capable of maintaining film optical density (OD) within  $\pm 0.15$  of the mean optical density when thickness of a homogeneous material is varied over a range of 2 to 6 cm and the kVp is varied appropriately for such thicknesses

§ 900.12

21 CFR Ch. I (4-1-20 Edition)

over the kVp range used clinically in the facility.

(C) The optical density of the film in the center of the phantom image shall not be less than 1.20.

(ii) *Kilovoltage peak (kVp) accuracy and reproducibility.* (A) The kVp shall be accurate within ±5 percent of the indicated or selected kVp at:

(1) The lowest clinical kVp that can be measured by a kVp test device;

(2) The most commonly used clinical kVp;

(3) The highest available clinical kVp, and

(B) At the most commonly used clinical settings of kVp, the coefficient of variation of reproducibility of the kVp shall be equal to or less than 0.02.

(iii) *Focal spot condition.* Until October 28, 2002, focal spot condition shall be evaluated either by determining system resolution or by measuring focal spot dimensions. After October 28, 2002, facilities shall evaluate focal spot condition only by determining the system resolution.

(A) *System resolution.* (1) Each X-ray system used for mammography, in combination with the mammography screen-film combination used in the facility, shall provide a minimum resolution of 11 Cycles/millimeter (mm) (line-pairs/mm) when a high contrast resolution bar test pattern is oriented with the bars perpendicular to the anode-cathode axis, and a minimum resolution of 13 line-pairs/mm when the bars are parallel to that axis.

(2) The bar pattern shall be placed 4.5 cm above the breast support surface, centered with respect to the chest wall edge of the image receptor, and with the edge of the pattern within 1 cm of the chest wall edge of the image receptor.

(3) When more than one target material is provided, the measurement in paragraph (e)(5)(iii)(A) of this section shall be made using the appropriate focal spot for each target material.

(4) When more than one SID is provided, the test shall be performed at SID most commonly used clinically.

(5) Test kVp shall be set at the value used clinically by the facility for a standard breast and shall be performed in the AEC mode, if available. If necessary, a suitable absorber may be

placed in the beam to increase exposure times. The screen-film cassette combination used by the facility shall be used to test for this requirement and shall be placed in the normal location used for clinical procedures.

(B) *Focal spot dimensions.* Measured values of the focal spot length (dimension parallel to the anode cathode axis) and width (dimension perpendicular to the anode cathode axis) shall be within the tolerance limits specified in table 1.

TABLE 1

Nominal Focal Spot Size (mm)	Focal Spot Tolerance Limit	
	Width(mm)	Length(mm)
0.10	0.15	0.15
0.15	0.23	0.23
0.20	0.30	0.30
0.30	0.45	0.65
0.40	0.60	0.85
0.60	0.90	1.30

(iv) *Beam quality and half-value layer (HVL).* The HVL shall meet the specifications of §1020.30(m)(1) of this chapter for the minimum HVL. These values, extrapolated to the mammographic range, are shown in table 2. Values not shown in table 2 may be determined by linear interpolation or extrapolation.

TABLE 2

X-ray Tube Voltage (kilovolt peak) and Minimum HVL		
Designed Operating Range (kV)	Measured Operating Voltage (kV)	Minimum HVL (millimeters of aluminum)
Below 50	20	0.20
	25	0.25
	30	0.30

(v) *Breast entrance air kerma and AEC reproducibility.* The coefficient of variation for both air kerma and mAs shall not exceed 0.05.

(vi) *Dosimetry.* The average glandular dose delivered during a single cranio-caudal view of an FDA-accepted phantom simulating a standard breast shall not exceed 3.0 milligray (mGy) (0.3 rad) per exposure. The dose shall be determined with technique factors and conditions used clinically for a standard breast.

(vii) *X-ray field/light field/image receptor/compression paddle alignment.* (A) All

systems shall have beam-limiting devices that allow the entire chest wall edge of the x-ray field to extend to the chest wall edge of the image receptor and provide means to assure that the x-ray field does not extend beyond any edge of the image receptor by more than 2 percent of the SID.

(B) If a light field that passes through the X-ray beam limitation device is provided, it shall be aligned with the X-ray field so that the total of any misalignment of the edges of the light field and the X-ray field along either the length or the width of the visually defined field at the plane of the breast support surface shall not exceed 2 percent of the SID.

(C) The chest wall edge of the compression paddle shall not extend beyond the chest wall edge of the image receptor by more than one percent of the SID when tested with the compression paddle placed above the breast support surface at a distance equivalent to standard breast thickness. The shadow of the vertical edge of the compression paddle shall not be visible on the image.

(viii) *Uniformity of screen speed.* Uniformity of screen speed of all the cassettes in the facility shall be tested and the difference between the maximum and minimum optical densities shall not exceed 0.30. Screen artifacts shall also be evaluated during this test.

(ix) *System artifacts.* System artifacts shall be evaluated with a high-grade, defect-free sheet of homogeneous material large enough to cover the mammography cassette and shall be performed for all cassette sizes used in the facility using a grid appropriate for the cassette size being tested. System artifacts shall also be evaluated for all available focal spot sizes and target filter combinations used clinically.

(x) *Radiation output.* (A) The system shall be capable of producing a minimum output of 4.5 mGy air kerma per second (513 milli Roentgen (mR) per second) when operating at 28 kVp in the standard mammography (moly/moly) mode at any SID where the system is designed to operate and when measured by a detector with its center located 4.5 cm above the breast support surface with the compression paddle in place between the source and the detec-

tor. After October 28, 2002, the system, under the same measuring conditions shall be capable of producing a minimum output of 7.0 mGy air kerma per second (800 mR per second) when operating at 28 kVp in the standard (moly/moly) mammography mode at any SID where the system is designed to operate.

(B) The system shall be capable of maintaining the required minimum radiation output averaged over a 3.0 second period.

(xi) *Decompression.* If the system is equipped with a provision for automatic decompression after completion of an exposure or interruption of power to the system, the system shall be tested to confirm that it provides:

(A) An override capability to allow maintenance of compression;

(B) A continuous display of the override status; and

(C) A manual emergency compression release that can be activated in the event of power or automatic release failure.

(6) *Quality control tests—other modalities.* For systems with image receptor modalities other than screen-film, the quality assurance program shall be substantially the same as the quality assurance program recommended by the image receptor manufacturer, except that the maximum allowable dose shall not exceed the maximum allowable dose for screen-film systems in paragraph (e)(5)(vi) of this section.

(7) *Mobile units.* The facility shall verify that mammography units used to produce mammograms at more than one location meet the requirements in paragraphs (e)(1) through (e)(6) of this section. In addition, at each examination location, before any examinations are conducted, the facility shall verify satisfactory performance of such units using a test method that establishes the adequacy of the image quality produced by the unit.

(8) *Use of test results.* (i) After completion of the tests specified in paragraphs (e)(1) through (e)(7) of this section, the facility shall compare the test results to the corresponding specified action limits; or, for nonscreen-film modalities, to the manufacturer's recommended action limits; or, for post-

move, preexamination testing of mobile units, to the limits established in the test method used by the facility.

(ii) If the test results fall outside of the action limits, the source of the problem shall be identified and corrective actions shall be taken:

(A) Before any further examinations are performed or any films are processed using a component of the mammography system that failed any of the tests described in paragraphs (e)(1), (e)(2), (e)(4)(i), (e)(4)(ii), (e)(4)(iii), (e)(5)(vi), (e)(6), or (e)(7) of this section;

(B) Within 30 days of the test date for all other tests described in paragraph (e) of this section.

(9) *Surveys.* (i) At least once a year, each facility shall undergo a survey by a medical physicist or by an individual under the direct supervision of a medical physicist. At a minimum, this survey shall include the performance of tests to ensure that the facility meets the quality assurance requirements of the annual tests described in paragraphs (e)(5) and (e)(6) of this section and the weekly phantom image quality test described in paragraph (e)(2) of this section.

(ii) The results of all tests conducted by the facility in accordance with paragraphs (e)(1) through (e)(7) of this section, as well as written documentation of any corrective actions taken and their results, shall be evaluated for adequacy by the medical physicist performing the survey.

(iii) The medical physicist shall prepare a survey report that includes a summary of this review and recommendations for necessary improvements.

(iv) The survey report shall be sent to the facility within 30 days of the date of the survey.

(v) The survey report shall be dated and signed by the medical physicist performing or supervising the survey. If the survey was performed entirely or in part by another individual under the direct supervision of the medical physicist, that individual and the part of the survey that individual performed shall also be identified in the survey report.

(10) *Mammography equipment evaluations.* Additional evaluations of mammography units or image processors shall be conducted whenever a new unit

or processor is installed, a unit or processor is disassembled and reassembled at the same or a new location, or major components of a mammography unit or processor equipment are changed or repaired. These evaluations shall be used to determine whether the new or changed equipment meets the requirements of applicable standards in paragraphs (b) and (e) of this section. All problems shall be corrected before the new or changed equipment is put into service for examinations or film processing. The mammography equipment evaluation shall be performed by a medical physicist or by an individual under the direct supervision of a medical physicist.

(11) *Facility cleanliness.* (i) The facility shall establish and implement adequate protocols for maintaining darkroom, screen, and view box cleanliness.

(ii) The facility shall document that all cleaning procedures are performed at the frequencies specified in the protocols.

(12) *Calibration of air kerma measuring instruments.* Instruments used by medical physicists in their annual survey to measure the air kerma or air kerma rate from a mammography unit shall be calibrated at least once every 2 years and each time the instrument is repaired. The instrument calibration must be traceable to a national standard and calibrated with an accuracy of  $\pm 6$  percent (95 percent confidence level) in the mammography energy range.

(13) *Infection control.* Facilities shall establish and comply with a system specifying procedures to be followed by the facility for cleaning and disinfecting mammography equipment after contact with blood or other potentially infectious materials. This system shall specify the methods for documenting facility compliance with the infection control procedures established and shall:

(i) Comply with all applicable Federal, State, and local regulations pertaining to infection control; and

(ii) Comply with the manufacturer's recommended procedures for the cleaning and disinfection of the mammography equipment used in the facility; or



(iii) If adequate manufacturer's recommendations are not available, comply with generally accepted guidance on infection control, until such recommendations become available.

(f) *Quality assurance-mammography medical outcomes audit.* Each facility shall establish and maintain a mammography medical outcomes audit program to followup positive mammographic assessments and to correlate pathology results with the interpreting physician's findings. This program shall be designed to ensure the reliability, clarity, and accuracy of the interpretation of mammograms.

(1) *General requirements.* Each facility shall establish a system to collect and review outcome data for all mammograms performed, including followup on the disposition of all positive mammograms and correlation of pathology results with the interpreting physician's mammography report. Analysis of these outcome data shall be made individually and collectively for all interpreting physicians at the facility. In addition, any cases of breast cancer among women imaged at the facility that subsequently become known to the facility shall prompt the facility to initiate followup on surgical and/or pathology results and review of the mammograms taken prior to the diagnosis of a malignancy.

(2) *Frequency of audit analysis.* The facility's first audit analysis shall be initiated no later than 12 months after the date the facility becomes certified, or 12 months after April 28, 1999, whichever date is the latest. This audit analysis shall be completed within an additional 12 months to permit completion of diagnostic procedures and data collection. Subsequent audit analyses will be conducted at least once every 12 months.

(3) *Audit interpreting physician.* Each facility shall designate at least one interpreting physician to review the medical outcomes audit data at least once every 12 months. This individual shall record the dates of the audit period(s) and shall be responsible for analyzing results based on this audit. This individual shall also be responsible for documenting the results and for notifying other interpreting physicians of their results and the facility aggregate

results. If followup actions are taken, the audit interpreting physician shall also be responsible for documenting the nature of the followup.

(g) *Mammographic procedure and techniques for mammography of patients with breast implants.* (1) Each facility shall have a procedure to inquire whether or not the patient has breast implants prior to the actual mammographic exam.

(2) Except where contraindicated, or unless modified by a physician's directions, patients with breast implants undergoing mammography shall have mammographic views to maximize the visualization of breast tissue.

(h) *Consumer complaint mechanism.* Each facility shall:

(1) Establish a written and documented system for collecting and resolving consumer complaints;

(2) Maintain a record of each serious complaint received by the facility for at least 3 years from the date the complaint was received;

(3) Provide the consumer with adequate directions for filing serious complaints with the facility's accreditation body if the facility is unable to resolve a serious complaint to the consumer's satisfaction;

(4) Report unresolved serious complaints to the accreditation body in a manner and timeframe specified by the accreditation body.

(i) *Clinical image quality.* Clinical images produced by any certified facility must continue to comply with the standards for clinical image quality established by that facility's accreditation body.

(j) *Additional mammography review and patient notification.* (1) If FDA believes that mammography quality at a facility has been compromised and may present a serious risk to human health, the facility shall provide clinical images and other relevant information, as specified by FDA, for review by the accreditation body or other entity designated by FDA. This additional mammography review will help the agency to determine whether the facility is in compliance with this section and, if not, whether there is a need to notify affected patients, their physicians, or the public that the reliability, clarity,

## § 900.13

and accuracy of interpretation of mammograms has been compromised.

(2) If FDA determines that the quality of mammography performed by a facility, whether or not certified under § 900.11, was so inconsistent with the quality standards established in this section as to present a significant risk to individual or public health, FDA may require such facility to notify patients who received mammograms at such facility, and their referring physicians, of the deficiencies presenting such risk, the potential harm resulting, appropriate remedial measures, and such other relevant information as FDA may require. Such notification shall occur within a timeframe and in a manner specified by FDA.

[62 FR 55976, Oct. 28, 1997; 62 FR 60614, Nov. 10, 1997, as amended at 63 FR 56558, Oct. 22, 1998; 64 FR 18333, Apr. 14, 1999; 64 FR 32408, June 17, 1999; 65 FR 43690, July 14, 2000]

## § 900.13 Revocation of accreditation and revocation of accreditation body approval.

(a) *FDA action following revocation of accreditation.* If a facility's accreditation is revoked by an accreditation body, the agency may conduct an investigation into the reasons for the revocation. Following such investigation, the agency may determine that the facility's certificate shall no longer be in effect or the agency may take whatever other action or combination of actions will best protect the public health, including the establishment and implementation of a corrective plan of action that will permit the certificate to continue in effect while the facility seeks reaccreditation. A facility whose certificate is no longer in effect because it has lost its accreditation may not practice mammography.

(b) *Withdrawal of FDA approval of an accreditation body.* (1) If FDA withdraws approval of an accreditation body under § 900.6, the certificates of facilities previously accredited by such body shall remain in effect for up to 1 year from the date of the withdrawal of approval, unless FDA determines, in order to protect human health or because the accreditation body fraudulently accredited facilities, that the certificates of some or all of the facilities should be revoked or suspended or

## 21 CFR Ch. I (4-1-20 Edition)

that a shorter time period should be established for the certificates to remain in effect.

(2) After 1 year from the date of withdrawal of approval of an accreditation body, or within any shorter period of time established by the agency, the affected facilities must obtain accreditation from another accreditation body, or from another entity designated by FDA.

## § 900.14 Suspension or revocation of certificates.

(a) Except as provided in paragraph (b) of this section, FDA may suspend or revoke a certificate if FDA finds, after providing the owner or operator of the facility with notice and opportunity for an informal hearing in accordance with part 16 of this chapter, that the owner, operator, or any employee of the facility:

(1) Has been guilty of misrepresentation in obtaining the certificate;

(2) Has failed to comply with the standards of § 900.12;

(3) Has failed to comply with reasonable requests of the agency or the accreditation body for records, information, reports, or materials that FDA believes are necessary to determine the continued eligibility of the facility for a certificate or continued compliance with the standards of § 900.12;

(4) Has refused a reasonable request of a duly designated FDA inspector, State inspector, or accreditation body representative for permission to inspect the facility or the operations and pertinent records of the facility;

(5) Has violated or aided and abetted in the violation of any provision of or regulation promulgated pursuant to 42 U.S.C. 263b; or

(6) Has failed to comply with prior sanctions imposed by the agency under 42 U.S.C. 263b(h).

(b) FDA may suspend the certificate of a facility before holding a hearing if FDA makes a finding described in paragraph (a) of this section and also determines that:

(1) The failure to comply with required standards presents a serious risk to human health;

(2) The refusal to permit inspection makes immediate suspension necessary; or

(3) There is reason to believe that the violation or aiding and abetting of the violation was intentional or associated with fraud.

(c) If FDA suspends a certificate in accordance with paragraph (b) of this section:

(1) The agency shall provide the facility with an opportunity for an informal hearing under part 16 of this chapter not later than 60 days from the effective date of this suspension;

(2) The suspension shall remain in effect until the agency determines that:

(i) Allegations of violations or misconduct were not substantiated;

(ii) Violations of required standards have been corrected to the agency's satisfaction; or

(iii) The facility's certificate is revoked in accordance with paragraph (d) of this section;

(d) After providing a hearing in accordance with paragraph (c)(1) of this section, the agency may revoke the facility's certificate if the agency determines that the facility:

(1) Is unwilling or unable to correct violations that were the basis for suspension; or

(2) Has engaged in fraudulent activity to obtain or continue certification.

**§900.15 Appeals of adverse accreditation or reaccreditation decisions that preclude certification or recertification.**

(a) The appeals procedures described in this section are available only for adverse accreditation or reaccreditation decisions that preclude certification or recertification by FDA. Agency decisions to suspend or revoke certificates that are already in effect will be handled in accordance with §900.14.

(b) Upon learning that a facility has failed to become accredited or reaccredited, FDA will notify the facility that the agency is unable to certify that facility without proof of accreditation.

(c) A facility that has been denied accreditation or reaccreditation is entitled to an appeals process from the accreditation body, in accordance with §900.7. A facility must avail itself of the accreditation body's appeal process before requesting reconsideration from FDA.

(d) A facility that cannot achieve satisfactory resolution of an adverse accreditation decision through the accreditation body's appeal process is entitled to further appeal in accordance with procedures set forth in this section and in regulations published in 42 CFR part 498.

(1) References to the Health Care Financing Administration (HCFA) in 42 CFR part 498 should be read as the Division of Mammography Quality and Radiation Programs (DMQRP), Center for Devices and Radiological Health, Food and Drug Administration.

(2) References to the Appeals Council of the Social Security Administration in 42 CFR part 498 should be read as references to the Departmental Appeals Board.

(3) In accordance with the procedures set forth in subpart B of 42 CFR part 498, a facility that has been denied accreditation following appeal to the accreditation body may request reconsideration of that adverse decision from DMQRP.

(i) A facility must request reconsideration by DMQRP within 60 days of the accreditation body's adverse appeals decision, at the following address: Food and Drug Administration, Center for Devices and Radiological Health, Division of Mammography Quality and Radiation Programs, Attn: Facility Accreditation Review Committee, 10903 New Hampshire Ave., Bldg. 66, rm. 4521, Silver Spring, MD 20993-0002.

(ii) The request for reconsideration shall include three copies of the following records:

(A) The accreditation body's original denial of accreditation.

(B) All information the facility submitted to the accreditation body as part of the appeals process;

(C) A copy of the accreditation body's adverse appeals decision; and

(D) A statement of the basis for the facility's disagreement with the accreditation body's decision.

(iii) DMQRP will conduct its reconsideration in accordance with the procedures set forth in subpart B of 42 CFR part 498.

(4) A facility that is dissatisfied with DMQRP's decision following reconsideration is entitled to a formal hearing

## § 900.16

## 21 CFR Ch. I (4–1–20 Edition)

in accordance with procedures set forth in subpart D of 42 CFR part 498.

(5) Either the facility or FDA may request review of the hearing officer's decision. Such review will be conducted by the Departmental Appeals Board in accordance with subpart E of 42 CFR part 498.

(6) A facility cannot perform mammography services while an adverse accreditation decision is being appealed.

[62 FR 55976, Oct. 28, 1997; 62 FR 60614, Nov. 10, 1997, as amended at 75 FR 20916, Apr. 22, 2010]

### § 900.16 Appeals of denials of certification.

(a) The appeals procedures described in this section are available only to facilities that are denied certification by FDA after they have been accredited by an approved accreditation body. Appeals for facilities that have failed to become accredited are governed by the procedures set forth in § 900.15.

(b) FDA may deny the application if the agency has reason to believe that:

(1) The facility will not be operated in accordance with standards established under § 900.12;

(2) The facility will not permit inspections or provide access to records or information in a timely fashion; or

(3) The facility has been guilty of misrepresentation in obtaining the accreditation.

(c)(1) If FDA denies an application for certification by a facility that has received accreditation from an approved accreditation body, FDA shall provide the facility with a statement of the grounds on which the denial is based.

(2) A facility that has been denied accreditation may request reconsideration and appeal of FDA's determination in accordance with the applicable provisions of § 900.15(d).

### § 900.17 [Reserved]

### § 900.18 Alternative requirements for § 900.12 quality standards.

(a) *Criteria for approval of alternative standards.* Upon application by a qualified party as defined in paragraph (b) of this section, FDA may approve an alternative to a quality standard under § 900.12, when the agency determines that:

(1) The proposed alternative standard will be at least as effective in assuring quality mammography as the standard it proposes to replace, and

(2) The proposed alternative:

(i) Is too limited in its applicability to justify an amendment to the standard; or

(ii) Offers an expected benefit to human health that is so great that the time required for amending the standard would present an unjustifiable risk to the human health; and

(3) The granting of the alternative is in keeping with the purposes of 42 U.S.C. 263b.

(b) *Applicants for alternatives.* (1) Mammography facilities and accreditation bodies may apply for alternatives to the quality standards of § 900.12.

(2) Federal agencies and State governments that are not accreditation bodies may apply for alternatives to the standards of § 900.12(a).

(3) Manufacturers and assemblers of equipment used for mammography may apply for alternatives to the standards of § 900.12(b) and (e).

(c) *Applications for approval of an alternative standard.* An application for approval of an alternative standard or for an amendment or extension of the alternative standard shall be submitted in an original and two copies to the Food and Drug Administration, Center for Devices and Radiological Health, Director, Division of Mammography Quality and Radiation Programs, 10903 New Hampshire Ave., Bldg. 66, rm. 4521, Silver Spring, MD 20993-0002. The application for approval of an alternative standard shall include the following information:

(1) Identification of the original standard for which the alternative standard is being proposed and an explanation of why the applicant is proposing the alternative;

(2) A description of the manner in which the alternative is proposed to deviate from the original standard;

(3) A description, supported by data, of the advantages to be derived from such deviation;

(4) An explanation, supported by data, of how such a deviation would ensure equal or greater quality of production, processing, or interpretation of

mammograms than the original standard;

(5) The suggested period of time that the proposed alternative standard would be in effect; and

(6) Such other information required by the Director to evaluate and act on the application.

(d) *Ruling on applications.* (1) FDA may approve or deny, in whole or in part, a request for approval of an alternative standard or any amendment or extension thereof, and shall inform the applicant in writing of this action. The written notice shall state the manner in which the requested alternative standard differs from the agency standard and a summary of the reasons for approval or denial of the request. If the request is approved, the written notice shall also include the effective date and the termination date of the approval and a summary of the limitations and conditions attached to the approval and any other information that may be relevant to the approved request. Each approved alternative standard shall be assigned an identifying number.

(2) Notice of an approved request for an alternative standard or any amendment or extension thereof shall be placed in the public docket file in the Division of Dockets Management and may also be in the form of a notice published in the FEDERAL REGISTER. The notice shall state the name of the applicant, a description of the published agency standard, and a description of the approved alternative standard, including limitations and conditions attached to the approval of the alternative standard.

(3) Summaries of the approval of alternative standards, including information on their nature and number, shall be provided to the National Mammography Quality Assurance Advisory Committee.

(4) All applications for approval of alternative standards and for amendments and extensions thereof and all correspondence (including written notices of approval) on these applications shall be available for public disclosure in the Division of Dockets Management, excluding patient identifiers and confidential commercial information.

(e) *Amendment or extension of an alternative standard.* An application for amending or extending approval of an alternative standard shall include the following information:

(1) The approval number and the expiration date of the alternative standard;

(2) The amendment or extension requested and the basis for the amendment or extension; and

(3) An explanation, supported by data, of how such an amendment or extension would ensure equal or greater quality of production, processing, or interpretation of mammograms than the original standard.

(f) *Applicability of the alternative standards.* (1) Except as provided in paragraphs (f)(2) and (f)(3) of this section, any approval of an alternative standard, amendment, or extension may be implemented only by the entity to which it was granted and under the terms under which it was granted. Other entities interested in similar or identical approvals must file their own application following the procedures of paragraph (c) of this section.

(2) When an alternative standard is approved for a manufacturer of equipment, any facility using that equipment will also be covered by the alternative standard.

(3) The agency may extend the alternative standard to other entities when FDA determines that expansion of the approval of the alternative standard would be an effective means of promoting the acceptance of measures to improve the quality of mammography. All such determinations will be publicized by appropriate means.

(g) *Withdrawal of approval of alternative requirements.* FDA shall amend or withdraw approval of an alternative standard whenever the agency determines that this action is necessary to protect the human health or otherwise is justified by § 900.12. Such action will become effective on the date specified in the written notice of the action sent

## § 900.20

to the applicant, except that it will become effective immediately upon notification of the applicant when FDA determines that such action is necessary to prevent an imminent health hazard.

[62 FR 55976, Oct. 28, 1997; 62 FR 60614, Nov. 10, 1997, as amended at 75 FR 20916, Apr. 22, 2010]

### Subpart C—States as Certifiers

SOURCE: 67 FR 5467, Feb. 6, 2002, unless otherwise noted.

#### § 900.20 Scope.

The regulations set forth in this part implement the Mammography Quality Standards Act (MQSA) (42 U.S.C. 263b). Subpart C of this part establishes procedures whereby a State can apply to become a FDA-approved certification agency to certify facilities within the State to perform mammography services. Subpart C of this part further establishes requirements and standards for State certification agencies to ensure that all mammography facilities under their jurisdiction are adequately and consistently evaluated for compliance with quality standards at least as stringent as the national quality standards established by FDA.

#### § 900.21 Application for approval as a certification agency.

(a) *Eligibility.* State agencies may apply for approval as a certification agency if they have standards at least as stringent as those of § 900.12, qualified personnel, adequate resources to carry out the States as Certifiers' responsibilities, and the authority to enter into a legal agreement with FDA to accept these responsibilities.

(b) *Application for approval.* (1) An applicant seeking FDA approval as a certification agency shall inform the Food and Drug Administration, Center for Devices and Radiological Health, Director, Division of Mammography Quality and Radiation Programs, Attn: States as Certifiers Coordinator, 10903 New Hampshire Ave., Bldg. 66, rm. 4521, Silver Spring, MD 20993-0002, in writing, of its desire to be approved as a certification agency.

(2) Following receipt of the written request, FDA will provide the applicant with additional information to aid in

## 21 CFR Ch. I (4–1–20 Edition)

the submission of an application for approval as a certification agency.

(3) The applicant shall furnish to FDA, at the address in paragraph (b)(1) of this section, three copies of an application containing the following information, materials, and supporting documentation:

(i) Name, address, and phone number of the applicant;

(ii) Detailed description of the mammography quality standards the applicant will require facilities to meet and, for those standards different from FDA's quality standards, information substantiating that they are at least as stringent as FDA standards under § 900.12;

(iii) Detailed description of the applicant's review and decisionmaking process for facility certification, including:

(A) Policies and procedures for notifying facilities of certificate denials and expirations;

(B) Procedures for monitoring and enforcement of the correction of deficiencies by facilities;

(C) Policies and procedures for suspending or revoking a facility's certification;

(D) Policies and procedures that will ensure processing certificates within a timeframe approved by FDA;

(E) A description of the appeals process for facilities contesting adverse certification status decisions;

(F) Education, experience, and training requirements of the applicant's professional and supervisory staff;

(G) Description of the applicant's electronic data management and analysis system;

(H) Fee schedules;

(I) Statement of policies and procedures established to avoid conflict of interest;

(J) Description of the applicant's mechanism for handling facility inquiries and complaints;

(K) Description of a plan to ensure that certified mammography facilities will be inspected according to MQSA (42 U.S.C. 263b) and procedures and policies for notifying facilities of inspection deficiencies;

(L) Policies and procedures for monitoring and enforcing the correction of facility deficiencies discovered during inspections or by other means;

(M) Policies and procedures for additional mammography review and for requesting such reviews from accreditation bodies;

(N) Policies and procedures for patient notification;

(O) If a State has regulations that are more stringent than those of § 900.12, an explanation of how adverse actions taken against a facility under the more stringent regulations will be distinguished from those taken under the requirements of § 900.12; and

(P) Any other information that FDA identifies as necessary to make a determination on the approval of the State as a certification agency.

(c) *Rulings on applications for approval.* (1) FDA will conduct a review and evaluation to determine whether the applicant substantially meets the applicable requirements of this subpart and whether the certification standards the applicant will require facilities to meet are the quality standards published under subpart B of this part or at least as stringent as those of subpart B.

(2) FDA will notify the applicant of any deficiencies in the application and request that those deficiencies be corrected within a specified time period. If the deficiencies are not corrected to FDA's satisfaction within the specified time period, FDA may deny the application for approval as a certification agency.

(3) FDA shall notify the applicant whether the application has been approved or denied. The notification shall list any conditions associated with approval or state the bases for any denial.

(4) The review of any application may include a meeting between FDA and representatives of the applicant at a time and location mutually acceptable to FDA and the applicant.

(5) FDA will advise the applicant of the circumstances under which a denied application may be resubmitted.

(d) *Scope of authority.* FDA may limit the scope of certification authority delegated to the State in accordance with MQSA.

[62 FR 55976, Oct. 28, 1997; 62 FR 60614, Nov. 10, 1997, as amended at 75 FR 20916, Apr. 22, 2010]

### § 900.22 Standards for certification agencies.

The certification agency shall accept the following responsibilities in order to ensure quality mammography at the facilities it certifies and shall perform these responsibilities in a manner that ensures the integrity and impartiality of the certification agency's actions:

(a) *Conflict of interest.* The certification agency shall establish and implement measures that FDA has approved in accordance with § 900.21(b) to reduce the possibility of conflict of interest or facility bias on the part of individuals acting on the certification agency's behalf.

(b) *Certification and inspection responsibilities.* Mammography facilities shall be certified and inspected in accordance with statutory and regulatory requirements that are at least as stringent as those of MQSA and this part.

(c) *Compliance with quality standards.* The scope, timeliness, disposition, and technical accuracy of completed inspections and related enforcement activities shall ensure compliance with facility quality standards required under § 900.12.

(d) *Enforcement actions.* (1) There shall be appropriate criteria and processes for the suspension and revocation of certificates.

(2) There shall be prompt investigation of and appropriate enforcement action for facilities performing mammography without certificates.

(e) *Appeals.* There shall be processes for facilities to appeal inspection findings, enforcement actions, and adverse certification decision or adverse accreditation decisions after exhausting appeals to the accreditation body.

(f) *Additional mammography review.* There shall be a process for the certification agency to request additional mammography review from accreditation bodies for issues related to mammography image quality and clinical practice. The certification agency should request additional mammography review only when it believes that mammography quality at a facility has been compromised and may present a serious risk to human health.

(g) *Patient notification.* There shall be processes for the certification agency to conduct, or cause to be conducted,

## § 900.23

## 21 CFR Ch. I (4–1–20 Edition)

patient notifications should the certification agency determine that mammography quality has been compromised to such an extent that it may present a serious risk to human health.

(h) *Electronic data transmission.* There shall be processes to ensure the timeliness and accuracy of electronic transmission of inspection data and facility certification status information in a format and timeframe determined by FDA.

(i) *Changes to standards.* A certification agency shall obtain FDA authorization for any changes it proposes to make in any standard that FDA has previously accepted under § 900.21 before requiring facilities to comply with the changes as a condition of obtaining or maintaining certification.

### § 900.23 Evaluation.

FDA shall evaluate annually the performance of each certification agency. The evaluation shall include the use of performance indicators that address the adequacy of program performance in certification, inspection, and enforcement activities. FDA will also consider any additional information deemed relevant by FDA that has been provided by the certification body or other sources or has been required by FDA as part of its oversight mandate. The evaluation also shall include a review of any changes in the standards or procedures in the areas listed in §§ 900.21(b) and 900.22 that have taken place since the original application or the last evaluation, whichever is most recent. The evaluation shall include a determination of whether there are major deficiencies in the certification agency's regulations or performance that, if not corrected, would warrant withdrawal of the approval of the certification agency under the provisions of § 900.24, or minor deficiencies that would require corrective action.

### § 900.24 Withdrawal of approval.

If FDA determines, through the evaluation activities of § 900.23, or through other means, that a certification agency is not in substantial compliance with this subpart, FDA may initiate the following actions:

(a) *Major deficiencies.* If, after providing notice and opportunity for cor-

rective action, FDA determines that a certification agency has demonstrated willful disregard for public health, has committed fraud, has failed to provide adequate resources for the program, has submitted material false statements to the agency, has failed to achieve the MQSA goals of quality mammography and access, or has performed or failed to perform a delegated function in a manner that may cause serious risk to human health, FDA may withdraw its approval of that certification agency. The certification agency shall notify, within a time period and in a manner approved by FDA, all facilities certified or seeking certification by it that it has been required to correct major deficiencies.

(1) FDA shall notify the certification agency of FDA's action and the grounds on which the approval was withdrawn.

(2) A certification agency that has lost its approval shall notify facilities certified or seeking certification by it, as well as the appropriate accreditation bodies with jurisdiction in the State, that its approval has been withdrawn. Such notification shall be made within a timeframe and in a manner approved by FDA.

(b) *Minor deficiencies.* If FDA determines that a certification agency has demonstrated deficiencies in performing certification functions and responsibilities that are less serious or more limited than the deficiencies in paragraph (a) of this section, including failure to follow the certification agency's own procedures and policies as approved by FDA, FDA shall notify the certification agency that it has a specified period of time to take particular corrective measures as directed by FDA or to submit to FDA for approval the certification agency's own plan of corrective action addressing the minor deficiencies. If the approved corrective actions are not being implemented satisfactorily or within the established schedule, FDA may place the agency on probationary status for a period of time determined by FDA, or may withdraw approval of the certification agency.

(1) If FDA places a certification agency on probationary status, the certification agency shall notify all facilities



**Food and Drug Administration, HHS**

**§ 900.25**

certified or seeking certification by it of its probationary status within a time period and in a manner approved by FDA.

(2) Probationary status shall remain in effect until such time as the certification agency can demonstrate to the satisfaction of FDA that it has successfully implemented or is implementing the corrective action plan within the established schedule, and that the corrective actions have substantially eliminated all identified problems, or

(3) If FDA determines that a certification agency that has been placed on probationary status is not implementing corrective actions satisfactorily or within the established schedule, FDA may withdraw approval of the certification agency. The certification agency shall notify all facilities certified or seeking certification by it, as well as the appropriate accreditation bodies with jurisdiction in the State, of its loss of FDA approval, within a

timeframe and in a manner approved by FDA.

(c) *Transfer of records.* A certification agency that has its approval withdrawn shall transfer facility records and other related information as required by FDA to a location and according to a schedule approved by FDA.

**§ 900.25 Hearings and appeals.**

(a) Opportunities to challenge final adverse actions taken by FDA regarding approval of certification agencies or withdrawal of approval of certification agencies shall be communicated through notices of opportunity for informal hearings in accordance with part 16 of this chapter.

(b) A facility that has been denied certification is entitled to an appeals process from the certification agency. The appeals process shall be specified in writing by the certification agency and shall have been approved by FDA in accordance with §§900.21 and 900.22.

## SUBCHAPTER J—RADIOLOGICAL HEALTH

### PART 1000—GENERAL

#### Subpart A—General Provisions

Sec.

1000.1 General.

1000.3 Definitions.

#### Subpart B—Statements of Policy and Interpretation

1000.15 Examples of electronic products subject to the Radiation Control for Health and Safety Act of 1968.

#### Subpart C—Radiation Protection Recommendations

1000.50 Recommendation for the use of specific area gonad shielding on patients during medical diagnostic x-ray procedures.

1000.55 Recommendation for quality assurance programs in diagnostic radiology facilities.

1000.60 Recommendation on administratively required dental x-ray examinations.

AUTHORITY: 21 U.S.C. 360hh-360ss.

SOURCE: 38 FR 28624, Oct. 15, 1973, unless otherwise noted.

#### Subpart A—General Provisions

##### § 1000.1 General.

References in this subchapter J to regulatory sections of the Code of Federal Regulations are to chapter I of title 21 unless otherwise noted.

[50 FR 33688, Aug. 20, 1985]

##### § 1000.3 Definitions.

As used in this subchapter J:

(a) *Accidental radiation occurrence* means a single event or series of events that has/have resulted in injurious or potentially injurious exposure of any person to electronic product radiation as a result of the manufacturing, testing, or use of an electronic product.

(b) *Act* means the Federal Food, Drug, and Cosmetic Act (21 U.S.C. 360hh-360ss).

(c) *Chassis family* means a group of one or more models with all of the following common characteristics:

(1) The same circuitry in the high voltage, horizontal oscillator, and power supply sections;

(2) The same worst component failures;

(3) The same type of high voltage hold-down or safety circuits; and

(4) The same design and installation.

(d) *Commerce* means:

(1) Commerce between any place in any State and any place outside thereof, and

(2) Commerce wholly within the District of Columbia.

(e) *Component*, for the purposes of this part, means an essential functional part of a subassembly or of an assembled electronic product, and which may affect the quantity, quality, direction, or radiation emission of the finished product.

(f) *Dealer* means a person engaged in the business of offering electronic products for sale to purchasers, without regard to whether such person is or has been primarily engaged in such business, and includes persons who offer such products for lease or as prizes or awards.

(g) *Director* means the Director of the Center for Devices and Radiological Health.

(h) *Distributor* means a person engaged in the business of offering electronic products for sale to dealers, without regard to whether such person is or has been primarily or customarily engaged in such business.

(i) *Electromagnetic radiation* includes the entire electromagnetic spectrum of radiation of any wavelength. The electromagnetic spectrum illustrated in figure 1 includes, but is not limited to, gamma rays, x-rays, ultra-violet, visible, infrared, microwave, radiowave, and low frequency radiation.

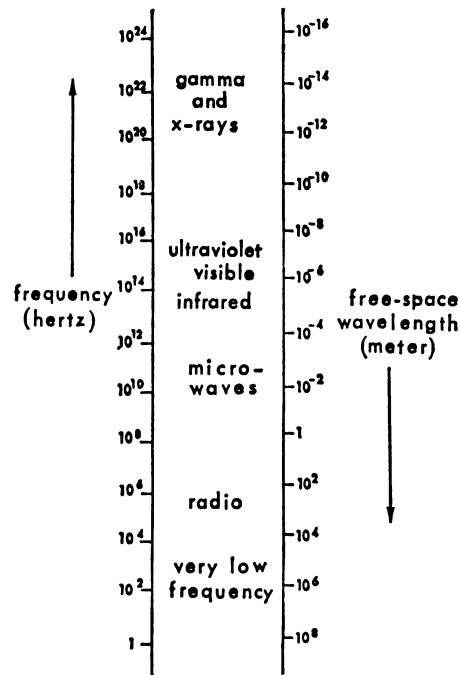

Figure 1. The Electromagnetic Spectrum

(j) *Electronic product* means:

(1) Any manufactured or assembled product which, when in operation:

(i) Contains or acts as part of an electronic circuit and

(ii) Emits (or in the absence of effective shielding or other controls would emit) electronic product radiation, or

(2) Any manufactured or assembled article that is intended for use as a component, part, or accessory of a product described in paragraph (j)(1) of this section and which, when in operation, emits (or in the absence of effective shielding or other controls would emit) such radiation.

(k) *Electronic product radiation* means:

(1) Any ionizing or nonionizing electromagnetic or particulate radiation, or

(2) Any sonic, infrasonic, or ultrasonic wave that is emitted from an electronic product as the result of the operation of an electronic circuit in such product.

(l) *Federal standard* means a performance standard issued pursuant to sec-

tion 534 of the Federal Food, Drug, and Cosmetic Act.

(m) *Infrasonic, sonic (or audible) and ultrasonic waves* refer to energy transmitted as an alteration (pressure, particle displacement or density) in a property of an elastic medium (gas, liquid or solid) that can be detected by an instrument or listener.

(n) *Manufacturer* means any person engaged in the business of manufacturing, assembling, or importing electronic products.

(o) *Model* means any identifiable, unique electronic product design, and refers to products having the same structural and electrical design characteristics and to which the manufacturer has assigned a specific designation to differentiate between it and other products produced by that manufacturer.

(p) *Model family* means products having similar design and radiation characteristics but different manufacturer model numbers.

§ 1000.15

21 CFR Ch. I (4-1-20 Edition)

(q) *Modified model* means a product that is redesigned so that actual or potential radiation emission, the manner of compliance with a standard, or the manner of radiation safety testing is affected.

(r) *Particulate radiation* is defined as:

(1) Charged particles, such as protons, electrons, alpha particles, or heavy particles, which have sufficient kinetic energy to produce ionization or atomic or electron excitation by collision, electrical attractions or electrical repulsion; or

(2) Uncharged particles, such as neutrons, which can initiate a nuclear transformation or liberate charged particles having sufficient kinetic energy to produce ionization or atomic or electron excitation.

(s) *Phototherapy product* means any ultraviolet lamp, or product containing such lamp, that is intended for irradiation of any part of the living human body by light in the wavelength range of 200 to 400 nanometers, in order to perform a therapeutic function.

(t) *Purchaser* means the first person who, for value, or as an award or prize, acquires an electronic product for purposes other than resale, and includes a person who leases an electronic product for purposes other than subleasing.

(u) *State* means a State, the District of Columbia, the Commonwealth of Puerto Rico, the Virgin Islands, Guam, and American Samoa.

[60 FR 48380, Sept. 19, 1995; 61 FR 13422, Mar. 27, 1996]

**Subpart B—Statements of Policy and Interpretation**

**§ 1000.15 Examples of electronic products subject to the Radiation Control for Health and Safety Act of 1968.**

The following listed electronic products are intended to serve as illustrative examples of sources of electronic product radiation to which the regulations of this part apply.

(a) Examples of electronic products which may emit x-rays and other ionizing electromagnetic radiation, electrons, neutrons, and other particulate radiation include:

Ionizing electromagnetic radiation:

Television receivers.  
Accelerators.  
X-ray machines (industrial, medical, research, educational).  
Particulate radiation and ionizing electromagnetic radiation:  
Electron microscopes.  
Neutron generators.

(b) Examples of electronic products which may emit ultraviolet, visible, infrared, microwaves, radio and low frequency electromagnetic radiation include:

Ultraviolet:  
Biochemical and medical analyzers.  
Tanning and therapeutic lamps.  
Sanitizing and sterilizing devices.  
Black light sources.  
Welding equipment.

Visible:  
White light devices.

Infrared:  
Alarm systems.  
Diathermy units.  
Dryers, ovens, and heaters.

Microwave:  
Alarm systems.  
Diathermy units.  
Dryers, ovens, and heaters.  
Medico-biological heaters.  
Microwave power generating devices.  
Radar devices.  
Remote control devices.  
Signal generators.

Radio and low frequency:  
Cauterizers.  
Diathermy units.  
Power generation and transmission equipment.  
Signal generators.  
Electromedical equipment.

(c) Examples of electronic products which may emit coherent electromagnetic radiation produced by stimulated emission include:

Laser:  
Art-form, experimental and educational devices.  
Biomedical analyzers.  
Cauterizing, burning and welding devices.  
Cutting and drilling devices.  
Communications transmitters.  
Rangefinding devices.

Maser:  
Communications transmitters.

(d) Examples of electronic products which may emit infrasonic, sonic, and ultrasonic vibrations resulting from operation of an electronic circuit include:

Infrasonic:  
Vibrators.

Sonic:  
 Electronic oscillators.  
 Sound amplification equipment.

Ultrasonic:  
 Cauterizers.  
 Cell and tissue disintegrators.  
 Cleaners.  
 Diagnostic and nondestructive testing equipment.  
 Ranging and detection equipment.

### Subpart C—Radiation Protection Recommendations

#### § 1000.50 Recommendation for the use of specific area gonad shielding on patients during medical diagnostic x-ray procedures.

Specific area gonad shielding covers an area slightly larger than the region of the gonads. It may therefore be used without interfering with the objectives of the examination to protect the germinal tissue of patients from radiation exposure that may cause genetic mutations during many medical x-ray procedures in which the gonads lie within or are in close proximity to the x-ray field. Such shielding should be provided when the following conditions exist:

(a) The gonads will lie within the primary x-ray field, or within close proximity (about 5 centimeters), despite proper beam limitation. Except as provided in paragraph (b) or (c) of this section:

(1) Specific area testicular shielding should always be used during those examinations in which the testes usually are in the primary x-ray field, such as examinations of the pelvis, hip, and upper femur;

(2) Specific area testicular shielding may also be warranted during other examinations of the abdominal region in which the testes may lie within or in close proximity to the primary x-ray field, depending upon the size of the patient and the examination techniques and equipment employed. Some examples of these are: Abdominal, lumbar spine and lumbosacral spine examinations, intravenous pyelograms, and abdominal scout film for barium enemas and upper GI series. Each x-ray facility should evaluate its procedures, techniques, and equipment and compile a list of such examinations for which specific area testicular shielding

should be routinely considered for use. As a basis for judgment, specific area testicular shielding should be considered for all examinations of male patients in which the pubic symphysis will be visualized on the film;

(3) Specific area gonad shielding should never be used as a substitute for careful patient positioning, the use of correct technique factors and film processing, or proper beam limitation (confinement of the x-ray field to the area of diagnostic interest), because this could result in unnecessary doses to other sensitive tissues and could adversely affect the quality of the radiograph; and

(4) Specific area gonad shielding should provide attenuation of x-rays at least equivalent to that afforded by 0.25 millimeter of lead.

(b) The clinical objectives of the examination will not be compromised.

(1) Specific area testicular shielding usually does not obscure needed information except in a few cases such as oblique views of the hip, retrograde urethrograms and voiding cystourethrograms, visualization of the rectum and, occasionally, the pubic symphysis. Consequently, specific area testicular shielding should be considered for use in the majority of x-ray examinations of male patients in which the testes will lie within the primary beam or within 5 centimeters of its edge. It is not always possible to position shields on male patients so that no bone is obscured. Therefore, if all bone structure of the pelvic area must be visualized for a particular patient, the use of shielding should be carefully evaluated. The decision concerning the applicability of shielding for an individual patient is dependent upon consideration of the patient's unique anthropometric characteristics and the diagnostic information needs of the examination.

(2) The use of specific area ovarian shielding is frequently impractical at present because the exact location of the ovaries is difficult to estimate, and the shield may obscure visualization of portions of adjacent structures such as the spine, ureters, and small and large bowels. However, it may be possible for

§ 1000.55

21 CFR Ch. I (4-1-20 Edition)

practitioners to use specific area ovarian shielding during selected views in some examinations.

(c) The patient has a reasonable reproductive potential.

(1) Specific area shielding need not be used on patients who cannot or are not likely to have children in the future.

(2) The following table of statistical data regarding the average number of children expected by potential parents in various age categories during their remaining lifetimes is provided for x-ray facilities that wish to use it as a basis for judging reproductive potential:

EXPECTED NUMBER OF FUTURE CHILDREN  
VERSUS AGE OF POTENTIAL PARENT<sup>1</sup>

Age	Male parent	Female parent
Fetus .....	2.6	2.6
0 to 4 .....	2.6	2.5
5 to 9 .....	2.7	2.5
10 to 14 .....	2.7	2.6
15 to 19 .....	2.7	2.6
20 to 24 .....	2.6	2.2
25 to 29 .....	2.0	1.4
30 to 34 .....	1.1	.6
35 to 39 .....	.5	.2
40 to 44 .....	.2	.04
45 to 49 .....	.07	0
50 to 54 .....	.03	0
55 to 64 .....	.01	0
Over 65 .....	0	0

<sup>1</sup>Derived from data published by the National Center for Health Statistics, "Final Natality Statistics 1970," HRA 74-1120, vol. 22, No. 12, Mar. 20, 1974.

[41 FR 30328, July 23, 1976; 41 FR 31812, July 30, 1976]

**§ 1000.55 Recommendation for quality assurance programs in diagnostic radiology facilities.**

(a) *Applicability.* Quality assurance programs as described in paragraph (c) of this section are recommended for all diagnostic radiology facilities.

(b) *Definitions.* As used in this section, the following definitions apply:

(1) *Diagnostic radiology facility* means any facility in which an x-ray system(s) is used in any procedure that involves irradiation of any part of the human body for the purpose of diagnosis or visualization. Offices of individual physicians, dentists, podiatrists, and chiropractors, as well as mobile laboratories, clinics, and hospitals are all examples of diagnostic radiology facilities.

(2) *Quality assurance* means the planned and systematic actions that provide adequate confidence that a diagnostic x-ray facility will produce consistently high quality images with minimum exposure of the patients and healing arts personnel. The determination of what constitutes high quality will be made by the facility producing the images. Quality assurance actions include both "quality control" techniques and "quality administration" procedures.

(3) *Quality assurance program* means an organized entity designed to provide "quality assurance" for a diagnostic radiology facility. The nature and extent of this program will vary with the size and type of the facility, the type of examinations conducted, and other factors.

(4) *Quality control techniques* are those techniques used in the monitoring (or testing) and maintenance of the components of an x-ray system. The quality control techniques thus are concerned directly with the equipment.

(5) *Quality administration procedures* are those management actions intended to guarantee that monitoring techniques are properly performed and evaluated and that necessary corrective measures are taken in response to monitoring results. These procedures provide the organizational framework for the quality assurance program.

(6) *X-ray system* means an assemblage of components for the controlled production of diagnostic images with x-rays. It includes minimally an x-ray high voltage generator, an x-ray control, a tube-housing assembly, a beam-limiting device, and the necessary supporting structures. Other components that function with the system, such as image receptors, image processors, view boxes, and darkrooms, are also parts of the system.

(c) *Elements.* A quality assurance program should contain the elements listed in paragraphs (c)(1) through (10) of this section. The extent to which each element of the quality assurance program is implemented should be determined by an analysis of the facility's objectives and resources conducted by its qualified staff or by qualified outside consultants. The extent of implementation should be determined on the

basis of whether the expected benefits in radiation exposure reduction, improved image quality, and/or financial savings will compensate for the resources required for the program.

(1) *Responsibility.* (i) Responsibility and authority for the overall quality assurance program as well as for monitoring, evaluation, and corrective measures should be specified and recorded in a quality assurance manual.

(ii) The owner or practitioner in charge of the facility has primary responsibility for implementing and maintaining the quality assurance program.

(iii) Staff technologists will generally be delegated a basic quality assurance role by the practitioner in charge. Responsibility for specific quality control monitoring and maintenance techniques or quality administration procedures may be assigned, provided that the staff technologists are qualified by training or experience for these duties. The staff technologists should also be responsible for identifying problems or potential problems requiring actions beyond the level of their training. They should bring these problems to the attention of the practitioner in charge, or his or her representative, so that assistance in solving the problems may be obtained from inside or outside the facility.

(iv) In facilities where they are available, physicists, supervisory technologists, or quality control technologists should have a major role in the quality assurance program. Such specialized personnel may be assigned responsibility for day-to-day administration of the program, may carry out monitoring duties beyond the level of training of the staff technologist or, if desired by the facility, may relieve the staff technologists of some or all of their basic monitoring duties. Staff service engineers may also be assigned responsibility for certain preventive or corrective maintenance actions.

(v) Responsibility for certain quality control techniques and corrective measures may be assigned to personnel qualified by training or experience, such as consultants or industrial representatives, from outside of the facility, provided there is a written agreement clearly specifying these services.

(vi) In large facilities, responsibility for long-range planning of quality assurance goals and activities should be assigned to a quality assurance committee as described in paragraph (c)(9) of this section.

(2) *Purchase specifications.* Before purchasing new equipment, the staff of the diagnostic radiology facility should determine the desired performance specifications for the equipment. Initially, these specifications may be stated in terms of the desired performance of the equipment, or prospective vendors may be informed solely of the functions the equipment should be able to perform and asked to provide the performance specifications of items from their equipment line that can perform these functions. In either case, the responses of the prospective vendors should serve as the basis for negotiations to establish the final purchase specifications, taking into account the state of the art and balancing the need for the specified performance levels with the cost of the equipment to meet them. The final purchase specifications should be in writing and should include performance specifications. The availability of experienced service personnel should also be taken into consideration in making the final purchase decisions. Any understandings with respect to service personnel should be incorporated into the purchase specifications. After the equipment is installed, the facility should conduct a testing program, as defined in its purchase specifications, to ensure that the equipment meets the agreed upon specifications, including applicable Federal and State regulatory requirements. The equipment should not be formally accepted until any necessary corrections have been made by the vendor. The purchase specifications and the records of the acceptance testing should be retained throughout the life of the equipment for comparison with monitoring results in order to assess continued acceptability of performance.

(3) *Monitoring and maintenance.* A routine quality control monitoring and maintenance system incorporating state-of-the-art procedures should be established and conducted on a regular schedule. The purpose of monitoring is

§ 1000.55

21 CFR Ch. I (4-1-20 Edition)

to permit evaluation of the performance of the facility's x-ray system(s) in terms of the standards for image quality established by the facility (as described in paragraph (c)(4) of this section) and compliance with applicable Federal and State regulatory requirements. The maintenance program should include corrective maintenance to eliminate problems revealed by monitoring or other means before they have a serious deleterious impact on patient care. To the extent permitted by the training of the facility staff, the maintenance program should also include preventive maintenance, which could prevent unexpected breakdowns of equipment and disruption of departmental routine.

(i) The parameters to be monitored in a facility should be determined by that facility on the basis of an analysis of expected benefits and cost. Such factors as the size and resources of the facility, the type of examinations conducted, and the quality assurance problems that have occurred in that or similar facilities should be taken into account in establishing the monitoring system. The monitoring frequency should also be based upon need and can be different for different parameters.

(ii) Although the parameters to be monitored will vary somewhat from facility to facility, every diagnostic radiology facility should consider monitoring the following five key components of the x-ray system:

- (a) Film processing.
- (b) Basic performance characteristics of the x-ray unit.
- (c) Cassettes and grids.
- (d) View boxes.
- (e) Darkroom.

(iii) Examples of parameters of the above-named components and of more specialized equipment that may be monitored are as follows:

- (a) For film processing:

An index of speed.  
An index of contrast.  
Base plus fog.  
Solution temperatures.  
Film artifact identification.

(b) For basic performance characteristics of the x-ray unit:

- (1) For fluoroscopic x-ray units:

Table-top exposure rates.  
Centering alignment.

Collimation.  
kVp accuracy and reproducibility.  
mA accuracy and reproducibility.  
Exposure time accuracy and reproducibility.  
Reproducibility of x-ray output.  
Focal spot size consistency.  
Half-value layer.  
Representative entrance skin exposures.

- (2) For image-intensified systems:

Resolution.  
Focusing.  
Distortion.  
Glare.  
Low contrast performance.  
Physical alignment of camera and collimating lens.

- (3) For radiographic x-ray units:

Reproducibility of x-ray output.  
Linearity and reproducibility of mA stations.  
Reproducibility and accuracy of timer stations.  
Reproducibility and accuracy of kVp stations.  
Accuracy of source-to-film distance indicators.  
Light/x-ray field congruence.  
Half-value layer.  
Focal spot size consistency.  
Representative entrance skin exposures.

- (4) For automatic exposure control devices:

Reproducibility.  
kVp compensation.  
Field sensitivity matching.  
Minimum response time.  
Backup timer verification.

- (c) For cassettes and grids:

- (1) For cassettes:

Film/screen contact.  
Screen condition.  
Light leaks.  
Artifact identification.

- (2) For grids:

Alignment and focal distance.  
Artifact identification.

- (d) For view boxes:

Consistency of light output with time.  
Consistency of light output from one box to another.  
View box surface conditions.

- (e) For darkrooms:

Darkroom integrity.  
Safe light conditions.

- (f) For specialized equipment:

- (1) For tomographic systems:

Accuracy of depth and cut indicator.



Thickness of cut plane.  
 Exposure angle.  
 Completeness of tomographic motion.  
 Flatness of tomographic field.  
 Resolution.  
 Continuity of exposure.  
 Flatness of cassette.  
 Representative entrance skin exposures.

(2) For computerized tomography:

Precision (noise).  
 Contrast scale.  
 High and low contrast resolution.  
 Alignment.  
 Representative entrance skin exposures.

(iv) The maintenance program should include both preventive and corrective aspects.

(a) *Preventive maintenance.* Preventive maintenance should be performed on a regularly scheduled basis with the goal of preventing breakdowns due to equipment failing without warning signs detectable by monitoring. Such actions have been found cost effective if responsibility is assigned to facility staff members. Possible preventive maintenance procedures are visual inspection of the mechanical and electrical characteristics of the x-ray system (covering such things as checking conditions of cables, watching the tomographic unit for smoothness of motion, assuring cleanliness with respect to spilling of contaminants in the examination room or the darkroom, and listening for unusual noises in the moving parts of the system), following the manufacturer's recommended procedures for cleaning and maintenance of the equipment, and regular inspection and replacement of switches and parts that routinely wear out or fail. The procedures included would depend upon the background of the staff members available. Obviously, a large facility with its own service engineers can do more than an individual practitioner's office.

(b) *Corrective maintenance.* For maximum effectiveness, the quality assurance program should make provision, as described in paragraph (c)(5) of this section, for ascertaining whether potential problems are developing. If potential or actual problems are detected, corrective maintenance should be carried out to eliminate them before they cause a major impact on patient care.

(4) *Standards for image quality.* Standards of acceptable image quality should be established. Ideally, these should be objective, e.g., acceptability limits for the variations of parameter values, but they may be subjective, e.g., the opinions of professional personnel, in cases where adequate objective standards cannot be defined. These standards should be routinely reviewed and redefined as needed, as described in paragraph (c)(10) of this section.

(5) *Evaluation.* The facility's quality assurance program should include means for two levels of evaluation.

(i) On the first level, the results of the monitoring procedures should be used to evaluate the performance of the x-ray system(s) to determine whether corrective actions are needed to adjust the equipment so that the image quality consistently meets the standards for image quality. This evaluation should include analysis of trends in the monitoring data as well as the use of the data to determine the need for corrective actions on a day-by-day basis. Comparison of monitoring data with the purchase specifications and acceptance testing results for the equipment in question is also useful.

(ii) On the second level, the facility quality assurance program should also include means for evaluating the effectiveness of the program itself. Possible means include ongoing studies of the retake rate and the causes of the repeated radiographs, examination of equipment repair and replacement costs, subjective evaluation of the radiographs being produced, occurrence and reasons for complaints by radiologists, and analysis of trends in the results of monitoring procedures such as sensitometric studies. Of these, ongoing studies of the retake rate (reject rate) and its causes are often the most useful and may also provide information of value in the first level of evaluation. Such studies can be used to evaluate potential for improvement, to make corrections, and to determine whether the corrective actions were effective. The number of rejects should be recorded daily or weekly, depending on the facility's analysis of its needs. Ideally, the reasons for the rejection

should also be determined and recorded. Should determining these reasons be impossible on a regular basis with the available staff, the analysis should be done for a 2-week period after major changes have occurred in diagnostic procedures or the x-ray system and at least semi-annually.

(6) *Records.* The program should include provisions for the keeping of records on the results of the monitoring techniques, any difficulties detected, the corrective measures applied to these difficulties, and the effectiveness of these measures. The extent and form of these records should be determined by the facility on the basis of its needs. The facility should view these records as a tool for maintaining an effective quality assurance program and not view the data in them as an end in itself but rather as a beginning. For example, the records should be made available to vendors to help them provide better service. More importantly, the data should be the basis for the evaluation and the reviews suggested in paragraphs (c)(5) and (10) of this section.

(7) *Manual.* A quality assurance manual should be written in a format permitting convenient revision as needed and should be made readily available to all personnel. The content of the manual should be determined by the facility staff, but the following items are suggested as providing essential information:

(i) A list of the individuals responsible for monitoring and maintenance techniques.

(ii) A list of the parameters to be monitored and the frequency of monitoring.

(iii) A description of the standards, criteria of quality, or limits of acceptability that have been established for each of the parameters monitored.

(iv) A brief description of the procedures to be used for monitoring each parameter.

(v) A description of procedures to be followed when difficulties are detected to call these difficulties to the attention of those responsible for correcting them.

(vi) A list of the publications in which detailed instructions for monitoring and maintenance procedures can

be found. Copies of these publications should also be readily available to the entire staff, but they should be separate from the manual. (Publications providing these instructions can usually be obtained from FDA or private sources, although the facility may wish to make some modifications to meet its needs more effectively.)

(vii) A list of the records, with sample forms, that the facility staff has decided should be kept. The facility staff should also determine and note in the manual the length of time each type of record should be kept before discarding.

(viii) A copy of each set of purchase specifications developed for new equipment and the results of the acceptance testing for that equipment.

(8) *Training.* The program should include provisions for appropriate training for all personnel with quality assurance responsibilities. This should include both training provided before the quality assurance responsibilities are assumed and continuing education to keep the personnel up-to-date. Practical experience with the techniques conducted under the supervision of experienced instructors, either in the facility or in a special program, is the most desirable type of training. The use of self-teaching materials can be an adequate substitute for supervised instruction, especially in continuing education programs, if supervised instruction is not available.

(9) *Committee.* A facility whose size would make it impractical for all staff members to meet for planning purposes should consider the establishment of a quality assurance committee whose primary function would be to maintain lines of communication among all groups with quality assurance and/or image production or interpretation responsibilities. For maximum communication, all departments of the facility with x-ray equipment should be represented. The committee may also be assigned policy-making duties such as some or all of the following:

Assign quality assurance responsibilities; maintain acceptable standards of quality; periodically review program effectiveness, etc. Alternatively, the

duties of this committee could be assigned to an already-existing committee such as the Radiation Safety Committee. In smaller facilities, all staff members should participate in the committee's tasks. The Quality Assurance Committee should report directly to the head of the radiology department, or, in facilities where more than one department operates x-ray equipment, to the chief medical officer of the facility. The committee should meet on a regular basis.

(10) *Review.* The facility's quality assurance program should be reviewed by the Quality Assurance Committee and/or the practitioner in charge to determine whether its effectiveness could be improved. Items suggested for inclusion in the review include:

(i) The reports of the monitoring and maintenance techniques to ensure that they are being performed on schedule and effectively. These reports should be reviewed at least quarterly.

(ii) The monitoring and maintenance techniques and their schedules to ensure that they continue to be appropriate and in step with the latest developments in quality assurance. They should be made current at least annually.

(iii) The standards for image quality to ensure that they are consistent with the state-of-the-art and the needs and resources of the facility. These standards should be evaluated at least annually.

(iv) The results of the evaluations of the effectiveness of the quality assurance actions to determine whether changes need to be made. This determination should be made at least annually.

(v) The quality assurance manual should also be reviewed at least annually to determine whether revision is needed.

[44 FR 71737, Dec. 11, 1979]

**§ 1000.60 Recommendation on administratively required dental x-ray examinations.**

(a) The Food and Drug Administration recommends that dental x-ray examinations be performed only after careful consideration of the dental or other health needs of the patient, that is, when the patient's dentist or physi-

cian judges them to be necessary for diagnosis, treatment, or prevention of disease. Administratively required dental x-ray examinations are those required by a remote third party for reasons not related to the patient's immediate dental needs. These x-ray examinations are usually a source of unnecessary radiation exposure to the patient. Because any unnecessary radiation exposure should be avoided, third parties should not require dental x-ray examinations unless they can demonstrate that such examinations provide a direct clinical benefit to the patient, and the patient's dentist or physician agrees with that assessment.

(b) Some examples of administrative x-ray examinations that should not be required by third parties are those intended solely:

(1) To monitor insurance claims or detect fraud;

(2) To satisfy a prerequisite for reimbursement;

(3) To provide training or experience;

(4) To certify qualifications or competence.

(c) This recommendation is not intended to preclude dental x-ray examinations ordered by the attending practitioner, based on the patient's history or physical examination, or those performed on selected populations shown to have significant yields of previously undiagnosed disease. This recommendation is also not intended to preclude the administrative use by third parties of dental radiographs that are taken on the order of the patient's dentist or physician as a necessary part of the patient's clinical care.

[45 FR 40978, June 17, 1980]

**PART 1002—RECORDS AND REPORTS**

**Subpart A—General Provisions**

Sec.

1002.1 Applicability.

1002.2 [Reserved]

1002.3 Notification to user of performance and technical data.

1002.4 Confidentiality of information.

1002.7 Submission of data and reports.

§ 1002.1

21 CFR Ch. I (4-1-20 Edition)

**Subpart B—Required Manufacturers' Reports for Listed Electronic Products**

- 1002.10 Product reports.
- 1002.11 Supplemental reports.
- 1002.12 Abbreviated reports.
- 1002.13 Annual reports.

**Subpart C—Manufacturers' Reports on Accidental Radiation Occurrences**

- 1002.20 Reporting of accidental radiation occurrences.

**Subpart D—Manufacturers' Records**

- 1002.30 Records to be maintained by manufacturers.
- 1002.31 Preservation and inspection of records.

**Subpart E—Dealer and Distributor Records**

- 1002.40 Records to be obtained by dealers and distributors.
- 1002.41 Disposition of records obtained by dealers and distributors.
- 1002.42 Confidentiality of records furnished by dealers and distributors.

**Subpart F—Exemptions From Records and Reports Requirements**

- 1002.50 Special exemptions.
- 1002.51 Exemptions for manufacturers of products intended for the U.S. Government.

AUTHORITY: 21 U.S.C. 352, 360, 360i, 360j, 360hh-360ss, 371, 374.

SOURCE: 38 FR 28625, Oct. 15, 1973, unless otherwise noted.

**Subpart A—General Provisions**

**§ 1002.1 Applicability.**

The provisions of this part are applicable as follows:

- (a) All manufacturers of electronic products are subject to § 1002.20.

(b) Manufacturers, dealers, and distributors of electronic products are subject to the provisions of part 1002 as set forth in table 1 of this section, unless excluded by paragraph (c) of this section, or unless an exemption has been granted under § 1002.50 or § 1002.51.

(c) The requirements of part 1002 as specified in table 1 of this section are not applicable to:

(1) Manufacturers of electronic products intended solely for export if such product is labeled or tagged to show that the product meets all the applicable requirements of the country to which such product is intended for export.

(2) Manufacturers of electronic products listed in table 1 of this section if such product is sold exclusively to other manufacturers for use as components of electronic products to be sold to purchasers, with the exception that the provisions are applicable to those manufacturers certifying components of diagnostic x-ray systems pursuant to provisions of § 1020.30(c) of this chapter.

(3) Manufacturers of electronic products that are intended for use by the U.S. Government and whose function or design cannot be divulged by the manufacturer for reasons of national security, as evidenced by government security classification.

(4) Assemblers of diagnostic x-ray equipment subject to the provisions of § 1020.30(d) of this chapter, provided the assembler has submitted the report required by § 1020.30(d)(1) or (d)(2) of this chapter and retains a copy of such report for a period of 5 years from its date.

TABLE 1—RECORD AND REPORTING REQUIREMENTS BY PRODUCT

Products	Manufacturer						Dealer & Distributor
	Product reports § 1002.10	Supplemental reports § 1002.11	Abbreviated reports § 1002.12	Annual reports § 1002.13	Test records § 1002.30(a) <sup>1</sup>	Distribution records § 1002.30(b) <sup>2</sup>	Distribution records §§ 1002.40 and 1002.41
DIAGNOSTIC X-RAY <sup>3</sup> (1020.30, 1020.31, 1020.32, 1020.33)							
Computed tomography	X	X		X	X	X	X
X-ray system <sup>4</sup>	X	X		X	X	X	X
Tube housing assembly	X	X		X	X	X	
X-ray control	X	X		X	X	X	X
X-ray high voltage generator	X	X		X	X	X	X

TABLE 1—RECORD AND REPORTING REQUIREMENTS BY PRODUCT—Continued

Products	Manufacturer						Dealer & Distributor
	Product reports § 1002.10	Supplemental reports § 1002.11	Abbreviated reports § 1002.12	Annual reports § 1002.13	Test records § 1002.30(a) <sup>1</sup>	Distribution records § 1002.30(b) <sup>2</sup>	Distribution records §§ 1002.40 and 1002.41
X-ray table or cradle			X		X	X	X
X-ray film changer			X		X	X	
Vertical cassette holders mounted in a fixed location and cassette holders with front panels			X		X	X	X
Beam-limiting devices	X	X		X	X	X	X
Spot-film devices and image intensifiers manufactured after April 26, 1977	X	X		X	X	X	X
Cephalometric devices manufactured after February 25, 1978			X		X	X	
Image receptor support devices for mammographic X-ray systems manufactured after September 5, 1978			X		X	X	X
CABINET X RAY (§ 1020.40)							
Baggage inspection	X	X		X	X	X	X
Other	X	X		X	X	X	
PRODUCTS INTENDED TO PRODUCE PARTICULATE RADIATION OR X-RAYS OTHER THAN DIAGNOSTIC OR CABINET DIAGNOSTIC X-RAY							
Medical			X	X	X	X	
Analytical			X	X	X	X	
Industrial			X	X	X	X	
TELEVISION PRODUCTS (§ 1020.10)							
<25 kilovolt (kV) and <0.1 milliroentgen per hour (mR/hr) IRLC <sup>5 6</sup>			X	X <sup>6</sup>			
≥25kV and <0.1mR/hr IRLC <sup>5</sup>	X	X		X			
≥0.1mR/hr IRLC <sup>5</sup>	X	X		X	X	X	
MICROWAVE/RF							
MW ovens (§ 1030.10)	X	X		X	X	X	
MW diathermy			X				
MW heating, drying, security systems			X				
RF sealers, electromagnetic induction and heating equipment, dielectric heaters (2–500 megahertz)			X				
OPTICAL							
Phototherapy products	X	X					
Laser products (§§ 1040.10, 1040.11)							
Class I lasers and products containing such lasers <sup>7</sup>	X			X	X		
Class I laser products containing class IIa, II, IIIa, lasers <sup>7</sup>	X			X	X	X	
Class IIa, II, IIIa lasers and products other than class I products containing such lasers <sup>7</sup>	X	X		X	X	X	X
Class IIIb and IV lasers and products containing such lasers <sup>7</sup>	X	X		X	X	X	X
Sunlamp products (§ 1040.20)							
Lamps only	X						
Sunlamp products	X	X		X	X	X	X
Mercury vapor lamps (§ 1040.30)							
T lamps	X	X		X			
R lamps			X				
ACOUSTIC							
Ultrasonic therapy (1050.10)	X	X		X	X	X	X
Diagnostic ultrasound			X				

TABLE 1—RECORD AND REPORTING REQUIREMENTS BY PRODUCT—Continued

Products	Manufacturer						Dealer & Distributor
	Product reports § 1002.10	Supplemental reports § 1002.11	Abbreviated reports § 1002.12	Annual reports § 1002.13	Test records § 1002.30(a) <sup>1</sup>	Distribution records § 1002.30(b) <sup>2</sup>	Distribution records §§ 1002.40 and 1002.41
Medical ultrasound other than therapy or diagnostic	X	X					
Nonmedical ultrasound			X				

<sup>1</sup>However, authority to inspect all appropriate documents supporting the adequacy of a manufacturer's compliance testing program is retained.  
<sup>2</sup>The requirement includes §§ 1002.31 and 1002.42, if applicable.  
<sup>3</sup>Report of Assembly (Form FDA 2579) is required for diagnostic x-ray components; see 21 CFR 1020.30(d)(1) through (d)(3).  
<sup>4</sup>Systems records and reports are required if a manufacturer exercises the option and certifies the system as permitted in 21 CFR 1020.30(c).  
<sup>5</sup>Determined using the isoexposure rate limit curve (IRLC) under phase III test conditions (1020.10(c)(3)(iii)).  
<sup>6</sup>Annual report is for production status information only.  
<sup>7</sup>Determination of the applicable reporting category for a laser product shall be based on the worst-case hazard present within the laser product.

[60 FR 48382, Sept. 19, 1995; 61 FR 13423, Mar. 27, 1996]

§ 1002.2 [Reserved]

§ 1002.3 Notification to user of performance and technical data.

The Director and Deputy Director of the Center for Devices and Radiological Health, as authorized under delegated authority, may require a manufacturer of a radiation emitting electronic product to provide to the ultimate purchaser, at the time of original purchase, such performance data and other technical data related to safety of the product as the Director or Deputy Director finds necessary.

[69 FR 17292, Apr. 2, 2004]

§ 1002.4 Confidentiality of information.

The Secretary or his representative shall not disclose any information reported to or otherwise obtained by him, pursuant to this part, which concerns or relates to a trade secret or other matter referred to in section 1905 of title 18 of the United States Code, except that such information may be disclosed to other officers or employees of the Department and of the other agencies concerned with carrying out the requirements of the Act. Nothing in this section shall authorize the withholding of information by the Secretary, or by any officers or employees under his control, from the duly authorized committees of the Congress.

§ 1002.7 Submission of data and reports.

All submissions such as reports, test data, product descriptions, and other information required by this part, or voluntarily submitted to the Director, Center for Devices and Radiological Health, shall be filed with the number of copies as prescribed by the Director, Center for Devices and Radiological Health, and shall be signed by the person making the submission. The submissions required by this part shall be addressed to the Food and Drug Administration, Center for Devices and Radiological Health, ATTN: Electronic Product Reports, Document Mail Center, 10903 New Hampshire Ave., Bldg. 66, rm. G609, Silver Spring, MD 20993-0002.

(a) In addition to the requirements of this part, all material submitted to the Director, Center for Devices and Radiological Health, shall be submitted pursuant to the provisions of part 20—Public Information, of this chapter.

(b) Where guides or instructions have been issued by the Director for the submission of material required by this part, such as test data, product reports, abbreviated reports, supplemental reports, and annual reports, the material submitted shall conform to the applicable reporting guides or instructions. Where it is not feasible or where it would not be appropriate to conform to any portion of a prescribed reporting

guide or instruction, an alternate format for providing the information requested by that portion of the guide or instruction may be used provided the submitter of such information submits adequate explanation and justification for use of an alternate format. If the Director, Center for Devices and Radiological Health, determines that such justification is inadequate and that it is feasible or appropriate to conform to the prescribed reporting guide or instruction, he may require resubmission of the information in conformance with the reporting guide or instruction.

(c) Where the submission of quality control and testing information is common to more than one model, or model family of the same product category, a "common aspects report" consolidating similar information may be provided, if applicable.

[42 FR 18062, Apr. 5, 1977, as amended at 53 FR 11254, Apr. 6, 1988; 60 FR 48385, Sept. 19, 1995; 72 FR 17400, Apr. 9, 2007; 75 FR 20916, Apr. 22, 2010]

### Subpart B—Required Manufacturers' Reports for Listed Electronic Products

SOURCE: 60 FR 48386, Sept. 19, 1995, unless otherwise noted.

#### § 1002.10 Product reports.

Every manufacturer of a product or component requiring a product report as set forth in table 1 of §1002.1 shall submit a product report to the Food and Drug Administration, Center for Devices and Radiological Health, ATTN: Electronic Product Reports, Document Mail Center, 10903 New Hampshire Ave., Bldg. 66, rm. G609, Silver Spring, MD 20993-0002, prior to the introduction of such product into commerce. The report shall be distinctly marked "Radiation Safety Product Report of (name of manufacturer)" and shall:

(a) Identify which listed product is being reported.

(b) Identify each model of the listed product together with sufficient information concerning the manufacturer's code or other system of labeling to enable the Director to determine the place of manufacture.

(c) Include information on all components and accessories provided in, on, or with the listed product that may affect the quantity, quality, or direction of the radiation emissions.

(d) Describe the function, operational characteristics affecting radiation emissions, and intended and known uses of each model of the listed product.

(e) State the standard or design specifications, if any, for each model with respect to electronic product radiation safety. Reference may be made to a Federal standard, if applicable.

(f) For each model, describe the physical or electrical characteristics, such as shielding or electronic circuitry, incorporated into the product in order to meet the standards or specifications reported pursuant to paragraph (e) of this section.

(g) Describe the methods and procedures employed, if any, in testing and measuring each model with respect to electronic product radiation safety, including the control of unnecessary, secondary, or leakage electronic product radiation, the applicable quality control procedures used for each model, and the basis for selecting such testing and quality control procedures.

(h) For those products which may produce increased radiation with aging, describe the methods and procedures used, and frequency of testing of each model for durability and stability with respect to electronic product radiation safety. Include the basis for selecting such methods and procedures, or for determining that such testing and quality control procedures are not necessary.

(i) Provide sufficient results of the testing, measuring, and quality control procedures described in accordance with paragraphs (g) and (h) of this section to enable the Director to determine the effectiveness of those test methods and procedures.

(j) Report for each model all warning signs, labels, and instructions for installation, operation, and use that relate to electronic product radiation safety.

(k) Provide, upon request, such other information as the Director may reasonably require to enable him/her to determine whether the manufacturer

## § 1002.11

has acted or is acting in compliance with the Act and any standards prescribed thereunder, and to enable the Director to carry out the purposes of the Act.

[60 FR 48386, Sept. 19, 1995, as amended at 72 FR 17400, Apr. 9, 2007; 75 FR 20916, Apr. 22, 2010]

### § 1002.11 Supplemental reports.

Prior to the introduction into commerce of a new or modified model within a model or chassis family of a product listed in table 1 of §1002.1 for which a report under §1002.10 is required, each manufacturer shall submit a report with respect to such new or modified model describing any changes in the information previously submitted in the product report. Reports will be required for changes that:

(a) Affect actual or potential radiation emission.

(b) Affect the manner of compliance with a standard or manner of testing for radiation safety.

### § 1002.12 Abbreviated reports.

Manufacturers of products requiring abbreviated reports as specified in table 1 of §1002.1 shall submit, prior to the introduction of such product, a report distinctly marked "Radiation Safety Abbreviated Report" which shall include:

(a) Firm and model identification.

(b) A brief description of operational characteristics that affect radiation emissions, transmission, or leakage or that control exposure.

(c) A list of applications or uses.

(d) Radiation emission, transmission, or leakage levels.

(e) If necessary, additional information as may be requested to determine compliance with the Act and this part.

### § 1002.13 Annual reports.

(a) Every manufacturer of products requiring an annual report as specified in table 1 of §1002.1 shall submit an annual report summarizing the contents of the records required to be maintained by §1002.30(a) and providing the volume of products produced, sold, or installed.

(b) Reports are due annually by September 1. Such reports shall cover the

## 21 CFR Ch. I (4–1–20 Edition)

12-month period ending on June 30 preceding the due date of the report.

(c) New models of a model family that do not involve changes in radiation emission or requirements of a performance standard do not require supplemental reports prior to introduction into commerce. These model numbers should be reported in quarterly updates to the annual report.

## Subpart C—Manufacturers' Reports on Accidental Radiation Occurrences

### § 1002.20 Reporting of accidental radiation occurrences.

(a) Manufacturers of electronic products shall, where reasonable grounds for suspecting that such an incident has occurred, immediately report to the Director, Center for Devices and Radiological Health, all accidental radiation occurrences reported to or otherwise known to the manufacturer and arising from the manufacturing, testing, or use of any product introduced or intended to be introduced into commerce by such manufacturer. Reasonable grounds include, but are not necessarily limited to, professional, scientific, or medical facts or opinions documented or otherwise, that conclude or lead to the conclusion that such an incident has occurred.

(b) Such reports shall be addressed to Food and Drug Administration, Center for Devices and Radiological Health, ATTN: Accidental Radiation Occurrence Reports, Document Mail Center, 10903 New Hampshire Ave., Bldg. 66, rm. G609, Silver Spring, MD 20993-0002, and the reports and their envelopes shall be distinctly marked "Report on 1002.20" and shall contain all of the following information where known to the manufacturer:

(1) The nature of the accidental radiation occurrence;

(2) The location at which the accidental radiation occurrence occurred;

(3) The manufacturer, type, and model number of the electronic product or products involved;

(4) The circumstances surrounding the accidental radiation occurrence, including causes;

(5) The number of persons involved, adversely affected, or exposed during



the accidental radiation occurrence, the nature and magnitude of their exposure and/or injuries and, if requested by the Director, Center for Devices and Radiological Health, the names of the persons involved;

(6) The actions, if any, which may have been taken by the manufacturer, to control, correct, or eliminate the causes and to prevent reoccurrence; and

(7) Any other pertinent information with respect to the accidental radiation occurrence.

(c) If a manufacturer is required to report to the Director under paragraph (a) of this section and also is required to report under part 803 of this chapter, the manufacturer shall report in accordance with part 803. If a manufacturer is required to report to the Director under paragraph (a) of this section and is not required to report under part 803, the manufacturer shall report in accordance with paragraph (a) of this section. A manufacturer need not file a separate report under this section if an incident involving an accidental radiation occurrence is associated with a defect or noncompliance and is reported pursuant to §1003.10 of this chapter.

[38 FR 28625, Oct. 15, 1973, as amended at 49 FR 36351, Sept. 14, 1984; 53 FR 11254, Apr. 6, 1988; 60 FR 48386, Sept. 19, 1995; 72 FR 17400, Apr. 9, 2007; 75 FR 20916, Apr. 22, 2010]

### Subpart D—Manufacturers' Records

#### § 1002.30 Records to be maintained by manufacturers.

(a) Manufacturers of products listed under table 1 of §1002.1 shall establish and maintain the following records with respect to such products:

(1) Description of the quality control procedures with respect to electronic product radiation safety.

(2) Records of the results of tests for electronic product radiation safety, including the control of unnecessary, secondary or leakage electronic product radiation, the methods, devices, and procedures used in such tests, and the basis for selecting such methods, devices, and procedures.

(3) For those products displaying aging effects which may increase elec-

tronic product radiation emission, records of the results of tests for durability and stability of the product, and the basis for selecting these tests.

(4) Copies of all written communications between the manufacturer and dealers, distributors, and purchasers concerning radiation safety including complaints, investigations, instructions, or explanations affecting the use, repair, adjustment, maintenance, or testing of the listed product.

(5) Data on production and sales volume levels if available.

(b) In addition to the records required by paragraph (a) of this section, manufacturers of products listed in table 1 of §1002.1 shall establish and maintain the following records with respect to such products:

(1) A record of the manufacturer's distribution of products in a form which will enable the tracing of specific products or production lots to distributors or to dealers in those instances in which the manufacturer distributes directly to dealers.

(2) Records received from dealers or distributors pursuant to §1002.41.

[38 FR 28625, Oct. 15, 1973, as amended at 60 FR 48386, Sept. 19, 1995; 75 FR 16352, Apr. 1, 2010]

#### § 1002.31 Preservation and inspection of records.

(a) Every manufacturer required to maintain records pursuant to this part, including records received pursuant to §1002.41, shall preserve such records for a period of 5 years from the date of the record.

(b) Upon reasonable notice by an officer or employee duly designated by the Department, manufacturers shall permit such officer or employee to inspect appropriate books, records, papers, and documents as are relevant to determining whether the manufacturer has acted or is acting in compliance with Federal standards.

(c) Upon request of the Director, Center for Devices and Radiological Health, a manufacturer of products listed in table 1 of §1002.1 shall submit to the Director, copies of the records

## § 1002.40

required to be maintained by paragraph (b) of § 1002.30.

[38 FR 28625, Oct. 15, 1973, as amended at 53 FR 11254, Apr. 6, 1988; 60 FR 48386, Sept. 19, 1995]

### Subpart E—Dealer and Distributor Records

#### § 1002.40 Records to be obtained by dealers and distributors.

(a) Dealers and distributors of electronic products for which there are performance standards and for which the retail price is \$50 or more shall obtain such information as is necessary to identify and locate first purchasers if the product is subject to this section by virtue of table 1 of § 1002.1.

(b) Such information shall include:

(1) The name and mailing address of the distributor, dealer, or purchaser to whom the product was transferred.

(2) Identification and brand name of the product.

(3) Model number and serial or other identification number of the product.

(4) Date of sale, award, or lease.

(c) The information obtained pursuant to this section shall be forwarded immediately to the appropriate manufacturer of the electronic product, or preserved as prescribed in § 1002.41.

[38 FR 28625, Oct. 15, 1973, as amended at 42 FR 18063, Apr. 5, 1977; 60 FR 48386, Sept. 19, 1995]

#### § 1002.41 Disposition of records obtained by dealers and distributors.

(a) Information obtained by dealers and distributors pursuant to § 1002.40 shall immediately be forwarded to the appropriate manufacturer unless:

(1) The dealer or distributor elects to hold and preserve such information and to immediately furnish it to the manufacturer when advised by the manufacturer or the Director, Center for Devices and Radiological Health, that such information is required for purposes of section 535 of the Act; and

(2) The dealer or distributor, upon making the election under paragraph (a)(1) of this section, promptly notifies the manufacturer of such election; such notification shall be in writing and shall identify the dealer or distributor and the electronic product or

## 21 CFR Ch. I (4–1–20 Edition)

products for which the information is being accumulated and preserved.

(b) Every dealer or distributor who elects to hold and preserve information required pursuant to § 1002.40 shall preserve the information for a period of 5 years from the date of the sale, award, or lease of the product, or until the dealer or distributor discontinues dealing in, or distributing the product, whichever is sooner. If the dealer or distributor discontinues dealing in, or distributing the product, such information as obtained pursuant to § 1002.40 shall be furnished at that time, or before, to the manufacturer of the product.

[38 FR 28625, Oct. 15, 1973, as amended at 42 FR 18063, Apr. 5, 1977; 53 FR 11254, Apr. 6, 1988; 75 FR 16352, Apr. 1, 2010]

#### § 1002.42 Confidentiality of records furnished by dealers and distributors.

All information furnished to manufacturers by dealers and distributors pursuant to this part shall be treated by such manufacturers as confidential information which may be used only as necessary to notify persons pursuant to section 535 of the Act.

[75 FR 16353, Apr. 1, 2010]

### Subpart F—Exemptions From Records and Reports Requirements

#### § 1002.50 Special exemptions.

(a) Manufacturers of electronic products may submit to the Director a request, together with accompanying justification, for exemption from any requirements listed in table 1 of § 1002.1. The request must specify each requirement from which an exemption is requested. In addition to other information that is required, the justification must contain documented evidence showing that the product or product type for which the exemption is requested does not pose a public health risk and meets at least one of the following criteria:

(1) The products cannot emit electronic product radiation in sufficient intensity or of such quality, under any conditions of operation, maintenance,

service, or product failure, to be hazardous;

(2) The products are produced in small quantities;

(3) The products are used by trained individuals and are to be used by the same manufacturing corporation or for research, investigation, or training.

(4) The products are custom designed and used by trained individuals knowledgeable of the hazards; or

(5) The products are produced in such a way that the requirements are inappropriate or unnecessary.

(b) The Director may, subject to any conditions that the Director deems necessary to protect the public health, exempt manufacturers from all or part of the record and reporting requirements of this part on the basis of information submitted in accordance with paragraph (a) of this section or such other information which the Director may possess if the Director determines that such exemption is in keeping with the purposes of the Act.

(c) The Director will provide written notification of the reason for any denial. If the exemption is granted, the Director will provide written notification of:

(1) The electronic product or products for which the exemption has been granted;

(2) The requirements from which the product is exempted; and

(3) Such conditions as are deemed necessary to protect the public health and safety. Copies of exemptions shall be available upon request from the Food and Drug Administration, Center for Devices and Radiological Health, Division of Mammography Quality and Radiation Programs, 10903 New Hampshire Ave., Bldg. 66, rm. 4521, Silver Spring, MD 20993-0002.

(d) The Director may, on the Director's own motion, exempt certain classes of products from the reporting requirements listed in table 1 of §1002.1, provided that the Director finds that such exemption is in keeping with the purposes of the act.

(e) Manufacturers of products for which there is no applicable performance standard under parts 1020 through 1050 of this chapter and for which an investigational device exemption has been approved under §812.30 of this

chapter or for which a premarket approval application has been approved in accordance with §814.44(d) of this chapter are exempt from submitting all reports listed in table 1 of §1002.1.

[60 FR 48387, Sept. 19, 1995, as amended at 72 FR 17401, Apr. 9, 2007; 75 FR 20916, Apr. 22, 2010]

#### **§1002.51 Exemptions for manufacturers of products intended for the U.S. Government.**

Upon application therefor by the manufacturer, the Director, Center for Devices and Radiological Health, may exempt from the provisions of this part a manufacturer of any electronic product intended for use by departments or agencies of the United States provided such department or agency has prescribed procurement specifications governing emissions of electronic product radiation and provided further that such product is of a type used solely or predominantly by departments or agencies of the United States.

[38 FR 28625, Oct. 15, 1973, as amended at 53 FR 11254, Apr. 6, 1988]

## **PART 1003—NOTIFICATION OF DEFECTS OR FAILURE TO COMPLY**

### **Subpart A—General Provisions**

Sec.

1003.1 Applicability.

1003.2 Defect in an electronic product.

1003.5 Effect of regulations on other laws.

### **Subpart B—Discovery of Defect or Failure To Comply**

1003.10 Discovery of defect or failure of compliance by manufacturer; notice requirements.

1003.11 Determination by Secretary that product fails to comply or has a defect.

### **Subpart C—Notification**

1003.20 Notification by the manufacturer to the Secretary.

1003.21 Notification by the manufacturer to affected persons.

1003.22 Copies of communications sent to purchasers, dealers, or distributors.

### **Subpart D—Exemptions from Notification Requirements**

1003.30 Application for exemption from notification requirements.

1003.31 Granting the exemption.

## § 1003.1

AUTHORITY: 21 U.S.C. 360hh-360ss.

SOURCE: 38 FR 28628, Oct. 15, 1973, unless otherwise noted.

### Subpart A—General Provisions

#### § 1003.1 Applicability.

The provisions of this part are applicable to electronic products which were manufactured after October 18, 1968.

#### § 1003.2 Defect in an electronic product.

For the purpose of this part, an electronic product shall be considered to have a defect which relates to the safety of use by reason of the emission of electronic product radiation if:

(a) It is a product which does not utilize the emission of electronic product radiation in order to accomplish its purpose, and from which such emissions are unintended, and as a result of its design, production or assembly;

(1) It emits electronic product radiation which creates a risk of injury, including genetic injury, to any person, or

(2) It fails to conform to its design specifications relating to electronic radiation emissions; or

(b) It is a product which utilizes electronic product radiation to accomplish its primary purpose and from which such emissions are intended, and as a result of its design, production or assembly it;

(1) Fails to conform to its design specifications relating to the emission of electronic product radiation; or

(2) Without regard to the design specifications of the product, emits electronic product radiation unnecessary to the accomplishment of its primary purpose which creates a risk of injury, including genetic injury to any person; or

(3) Fails to accomplish the intended purpose.

#### § 1003.5 Effect of regulations on other laws.

The remedies provided for in this subchapter shall be in addition to and not in substitution for any other remedies provided by law and shall not relieve any person from liability at common law or under statutory law.

## 21 CFR Ch. I (4-1-20 Edition)

### Subpart B—Discovery of Defect or Failure To Comply

#### § 1003.10 Discovery of defect or failure of compliance by manufacturer; notice requirements.

Any manufacturer who discovers that any electronic product produced, assembled, or imported by him, which product has left its place of manufacture, has a defect or fails to comply with an applicable Federal standard shall:

(a) Immediately notify the Secretary in accordance with § 1003.20, and

(b) Except as authorized by § 1003.30, furnish notification with reasonable promptness to the following persons:

(1) The dealers or distributors to whom such product was delivered by the manufacturer; and

(2) The purchaser of such product and any subsequent transferee of such product (where known to the manufacturer or where the manufacturer upon reasonable inquiry to dealers, distributors, or purchasers can identify the present user).

(c) If a manufacturer is required to notify the Secretary under paragraph (a) of this section and also is required to report to the Food and Drug Administration under part 803 of this chapter, the manufacturer shall report in accordance with part 803. If a manufacturer is required to notify the Secretary under paragraph (a) of this section and is not required to report to the Food and Drug Administration under part 803, the manufacturer shall notify the Secretary in accordance with paragraph (a) of this section.

[38 FR 28628, Oct. 15, 1973 and 49 FR 36351, Sept. 14, 1984]

#### § 1003.11 Determination by Secretary that product fails to comply or has a defect.

(a) If, the Secretary, through testing, inspection, research, or examination of reports or other data, determines that any electronic product does not comply with an applicable Federal standard issued pursuant to the Act or has a defect, he shall immediately notify the manufacturer of the product in writing specifying:

(1) The defect in the product or the manner in which the product fails to

comply with the applicable Federal standard;

(2) The Secretary's findings, with references to the tests, inspections, studies, or reports upon which such findings are based;

(3) A reasonable period of time during which the manufacturer may present his views and evidence to establish that there is no failure of compliance or that the alleged defect does not exist or does not relate to safety of use of the product by reason of the emission of electronic product radiation.

The manufacturer shall have an opportunity for a regulatory hearing before the Food and Drug Administration pursuant to part 16 of this chapter.

(b) Every manufacturer who receives a notice under paragraph (a) of this section shall immediately advise the Secretary in writing of the total number of such product units produced and the approximate number of such product units which have left the place of manufacture.

(c) If, after the expiration of the period of time specified in the notice, the Secretary determines that the product has a defect or does not comply with an applicable Federal standard and the manufacturer has not applied for an exemption, he shall direct the manufacturer to furnish the notification to the persons specified in §1003.10(b) in the manner specified in §1003.21. The manufacturer shall within 14 days from the date of receipt of such directive furnish the required notification.

[38 FR 28628, Oct. 15, 1973, as amended at 41 FR 48269, Nov. 2, 1976; 42 FR 15676, Mar. 22, 1977]

### Subpart C—Notification

#### §1003.20 Notification by the manufacturer to the Secretary.

The notification to the Secretary required by §1003.10(a) shall be confirmed in writing and, in addition to other relevant information which the Secretary may require, shall include the following:

(a) Identification of the product or products involved;

(b) The total number of such product units so produced, and the approximate number of such product units which have left the place of manufacture;

(c) The expected usage for the product if known to the manufacturer;

(d) A description of the defect in the product or the manner in which the product fails to comply with an applicable Federal standard;

(e) An evaluation of the hazards reasonably related to defect or the failure to comply with the Federal standard;

(f) A statement of the measures to be taken to repair such defect or to bring the product into compliance with the Federal standard;

(g) The date and circumstances under which the defect was discovered; and

(h) The identification of any trade secret information which the manufacturer desires kept confidential.

#### §1003.21 Notification by the manufacturer to affected persons.

(a) The notification to the persons specified in §1003.10(b) shall be in writing and, in addition to other relevant information which the Secretary may require, shall include:

(1) The information prescribed by §1003.20 (a), (d), and instructions with respect to the use of the product pending the correction of the defect;

(2) A clear evaluation in nontechnical terms of the hazards reasonably related to any defect or failure to comply; and

(3) The following statement:

The manufacturer will, without charge, remedy the defect or bring the product into compliance with each applicable Federal standard in accordance with a plan to be approved by the Secretary of Health and Human Services, the details of which will be included in a subsequent communication to you.

*Provided,* That if at the time the notification is sent, the Secretary has approved a plan for the repair, replacement or refund of the product, the notification may include the details of the approved plan in lieu of the above statement.

(b) The envelope containing the notice shall not contain advertising or other extraneous material, and such mailings will be made in accordance with this section.

(1) No. 10 white envelopes shall be used, and the name and address of the manufacturer shall appear in the upper left corner of the envelope.

## § 1003.22

(2) The following statement is to appear in the far left third of the envelope in the type and size indicated and in reverse printing, centered in a red rectangle 3¾ inches wide and 2¼ inches high:

IMPORTANT—ELECTRONIC PRODUCT RADIATION  
WARNING

The statement shall be in three lines, all capitals, and centered. "Important" shall be in 36-point Gothic Bold type. "Electronic Product" and "Radiation Warning" shall be in 36-point Gothic Condensed type.

(3) Envelopes with markings similar to those prescribed in this section shall not be used by manufacturers for mailings other than those required by this part.

(c) The notification shall be sent:

(1) By certified mail to purchasers of the product and to subsequent transferees.

(2) By certified mail or other more expeditious means to dealers and distributors.

(d) Where products were sold under a name other than that of the manufacturer of the product, the name of the individual or company under whose name the product was sold may be used in the notification required by this section.

## § 1003.22 Copies of communications sent to purchasers, dealers or distributors.

(a) Every manufacturer of electronic products shall furnish to the Secretary a copy of all notices, bulletins, or other communications sent to the dealers or distributors of such manufacturers or to purchasers (or subsequent transferees) of electronic products of such manufacturer regarding any defect in such product or any failure of such product to comply with an applicable Federal standard.

(b) In the event the Secretary deems the content of such notices to be insufficient to protect the public health and safety, the Secretary may require additional notice to such recipients, or may elect to make or cause to be made such notification by whatever means he deems appropriate.

## 21 CFR Ch. I (4–1–20 Edition)

### Subpart D—Exemptions From Notification Requirements

#### § 1003.30 Application for exemption from notification requirements.

(a) A manufacturer may at the time of giving the written confirmation required by § 1003.20 or within 15 days of the receipt of any notice from the Secretary pursuant to § 1003.11(a), apply for an exemption from the requirement of notice to the persons specified in § 1003.10(b).

(b) The application for exemption shall contain the information required by § 1003.20 and in addition shall set forth in detail the grounds upon which the exemption is sought.

#### § 1003.31 Granting the exemption.

(a) If, in the judgment of the Secretary, the application filed pursuant to § 1003.30 states reasonable grounds for an exemption from the requirement of notice, the Secretary shall give the manufacturer written notice specifying a reasonable period of time during which he may present his views and evidence in support of the application.

(b) Such views and evidence shall be confined to matters relevant to whether the defect in the product or its failure to comply with an applicable Federal standard is such as to create a significant risk of injury, including genetic injury, to any person and shall be presented in writing unless the Secretary determines that an oral presentation is desirable. Where such evidence includes nonclinical laboratory studies, the data submitted shall include, with respect to each such study, either a statement that the study was conducted in compliance with the requirements set forth in part 58 of this chapter, or, if the study was not conducted in compliance with such regulations, a brief statement of the reason for the noncompliance. When such evidence includes clinical investigations involving human subjects, the data submitted shall include, with respect to each clinical investigation either a statement that each investigation was conducted in compliance with the requirements set forth in part 56 of this chapter, or a statement that the investigation is not subject to such requirements in accordance with § 56.104 or

§56.105, and a statement that each investigation was conducted in compliance with the requirements set forth in part 50 of this chapter.

(c) If, during the period of time afforded the manufacturer to present his views and evidence, the manufacturer proves to the Secretary's satisfaction that the defect or failure to comply does not create a significant risk of injury, including genetic injury, to any person, the Secretary shall issue an exemption from the requirement of notification to the manufacturer and shall notify the manufacturer in writing specifying:

(1) The electronic product or products for which the exemption has been issued; and

(2) Such conditions as the Secretary deems necessary to protect the public health and safety.

(d) Any person who contests denial of an exemption shall have an opportunity for a regulatory hearing before the Food and Drug Administration pursuant to part 16 of this chapter.

[38 FR 28628, Oct. 15, 1973, as amended at 41 FR 48269, Nov. 2, 1976; 42 FR 15676, Mar. 22, 1977; 50 FR 7518, Feb. 22, 1985]

## PART 1004—REPURCHASE, REPAIRS, OR REPLACEMENT OF ELECTRONIC PRODUCTS

Sec.

1004.1 Manufacturer's obligation to repair, replace, or refund cost of electronic products.

1004.2 Plans for the repair of electronic products.

1004.3 Plans for the replacement of electronic products.

1004.4 Plans for refunding the cost of electronic products.

1004.6 Approval of plans.

AUTHORITY: 21 U.S.C. 360hh-360ss.

SOURCE: 38 FR 28629, Oct. 15, 1973, unless otherwise noted.

### § 1004.1 Manufacturer's obligation to repair, replace, or refund cost of electronic products.

(a) If any electronic product fails to comply with an applicable Federal standard or has a defect and the notification specified in §1003.10(b) of this chapter is required to be furnished, the manufacturer of such product shall;

(1) Without charge, bring such product into conformity with such standard or remedy such defect and provide reimbursement for any expenses for transportation of such product incurred in connection with having such product brought into conformity or having such defect remedied; or

(2) Replace such product with a like or equivalent product which complies with each applicable Federal standard and which has no defect relating to the safety of its use; or

(3) Make a refund of the cost of the product to the purchaser.

(b) The manufacturer shall take the action required by this section in accordance with a plan approved by the Secretary pursuant to §1004.6.

### § 1004.2 Plans for the repair of electronic products.

Every plan for bringing an electronic product into conformity with applicable Federal standards or for remedying any defect in such product shall be submitted to the Secretary in writing, and in addition to other relevant information which the Secretary may require, shall include:

(a) Identification of the product involved.

(b) The approximate number of defective product units which have left the place of manufacture.

(c) The specific modifications, alterations, changes, repairs, corrections, or adjustments to be made to bring the product into conformity or remedy any defect.

(d) The manner in which the operations described in paragraph (c) will be accomplished, including the procedure for obtaining access to, or possession of, the products and the location where such operations will be performed.

(e) The technical data, test results or studies demonstrating the effectiveness of the proposed remedial action.

(f) A time limit, reasonable in light of the circumstances, for completion of the operations.

(g) The system by which the manufacturer will provide reimbursement for any transportation expenses incurred in connection with having such product brought into conformity or having any defect remedied.

### § 1004.3

(h) The text of the statement which the manufacturer will send to the persons specified in §1003.10(b) of this chapter informing such persons;

(1) That the manufacturer, at his expense, will repair the electronic product involved,

(2) Of the method by which the manufacturer will obtain access to or possession of the product to make such repairs,

(3) That the manufacturer will reimburse such persons for any transportation expenses incurred in connection with making such repairs, and

(4) Of the manner in which such reimbursement will be effected.

(i) An assurance that the manufacturer will provide the Secretary with progress reports on the effectiveness of the plan, including the number of electronic products repaired.

#### §1004.3 Plans for the replacement of electronic products.

Every plan for replacing an electronic product with a like or equivalent product shall be submitted to the Secretary in writing, and in addition to other relevant information which the Secretary may require, shall include:

(a) Identification of the product to be replaced.

(b) A description of the replacement product in sufficient detail to support the manufacturer's contention that the replacement product is like or equivalent to the product being replaced.

(c) The approximate number of defective product units which have left the place of manufacture.

(d) The manner in which the replacement operation will be effected including the procedure for obtaining possession of the product to be replaced.

(e) A time limit, reasonable, in light of the circumstances for completion of the replacement.

(f) The steps which the manufacturer will take to insure that the defective product will not be reintroduced into commerce, until it complies with each applicable Federal standard and has no defect relating to the safety of its use.

(g) The system by which the manufacturer will provide reimbursement for any expenses for transportation of such product incurred in connection with effecting the replacement.

### 21 CFR Ch. I (4-1-20 Edition)

(h) The text of the statement which the manufacturer will send to the persons specified in §1003.10(b) of this chapter informing such persons;

(1) That the manufacturer, at its expense, will replace the electronic product involved,

(2) Of the method by which the manufacturer will obtain possession of the product and effect the replacement,

(3) That the manufacturer will reimburse such persons for any transportation expenses incurred in connection with effecting such replacement, and

(4) Of the manner in which such reimbursement will be made.

(i) An assurance that the manufacturer will provide the Secretary with progress reports on the effectiveness of the plan, including the number of electronic products replaced.

#### §1004.4 Plans for refunding the cost of electronic products.

Every plan for refunding the cost of an electronic product shall be submitted to the Secretary in writing, and in addition to other relevant information which the Secretary may require, shall include:

(a) Identification of the product involved.

(b) The approximate number of defective product units which have left the place of manufacture.

(c) The manner in which the refund operation will be effected including the procedure for obtaining possession of the product for which the refund is to be made.

(d) The steps which the manufacturer will take to insure that the defective products will not be reintroduced into commerce, until it complies with each applicable Federal standard and has no defect relating to the safety of its use.

(e) A time limit, reasonable in light of the circumstances, for obtaining the product and making the refund.

(f) A statement that the manufacturer will refund the cost of such product together with the information the manufacturer has used to determine the amount of the refund.

(g) The text of the statement which the manufacturer will send to the persons specified in §1003.10(b) of this chapter informing such persons;



## Food and Drug Administration, HHS

## § 1005.3

(1) That the manufacturer, at his expense, will refund the cost of the electronic product plus any transportation costs,

(2) Of the amount to be refunded exclusive of transportation costs,

(3) Of the method by which the manufacturer will obtain possession of the product and make the refund.

(h) An assurance that the manufacturer will provide the Secretary with progress reports on the effectiveness of the plan, including the number of refunds made.

### § 1004.6 Approval of plans.

If, after review of any plan submitted pursuant to this subchapter, the Secretary determines that the action to be taken by the manufacturer will expeditiously and effectively fulfill the manufacturer's obligation under §1004.1 in a manner designed to encourage the public to respond to the proposal, the Secretary will send written notice of his approval of such plan to the manufacturer. Such approval may be conditioned upon such additional terms as the Secretary deems necessary to protect the public health and safety. Any person who contests denial of a plan shall have an opportunity for a regulatory hearing before the Food and Drug Administration pursuant to part 16 of this chapter.

[38 FR 28629, Oct. 15, 1973, as amended at 41 FR 48269, Nov. 2, 1976; 42 FR 15676, Mar. 22, 1977]

## PART 1005—IMPORTATION OF ELECTRONIC PRODUCTS

### Subpart A—General Provisions

Sec.

1005.1 Applicability.

1005.2 Definitions.

1005.3 Importation of noncomplying goods prohibited.

### Subpart B—Inspection and Testing

1005.10 Notice of sampling.

1005.11 Payment for samples.

### Subpart C—Bonding and Compliance Procedures

1005.20 Hearing.

1005.21 Application for permission to bring product into compliance.

1005.22 Granting permission to bring product into compliance.

1005.23 Bonds.

1005.24 Costs of bringing product into compliance.

1005.25 Service of process on manufacturers.

AUTHORITY: 21 U.S.C. 360ii, 360mm.

SOURCE: 38 FR 28630, Oct. 15, 1973, unless otherwise noted.

## Subpart A—General Provisions

### § 1005.1 Applicability.

(a) The provisions of §§1005.1 through 1005.24 are applicable to electronic products which are subject to the standards prescribed under this subchapter and are offered for importation into the United States.

(b) Section 1005.25 is applicable to every manufacturer of electronic products offering an electronic product for importation into the United States.

[38 FR 28630, Oct. 15, 1973, as amended at 45 FR 81739, Dec. 12, 1980]

### § 1005.2 Definitions.

As used in this part:

The term *owner* or *consignee* means the person who makes entry under the provisions of section 484 of the Tariff Act of 1930, as amended (19 U.S.C. 1484), namely, the "importer of record."

[81 FR 85973, Nov. 29, 2016]

### § 1005.3 Importation of noncomplying goods prohibited.

The importation of any electronic product for which standards have been prescribed under section 534 of the Federal Food, Drug, and Cosmetic Act (the act) (21 U.S.C. 360kk) shall be refused admission into the United States unless there is affixed to such product a certification in the form of a label or tag in conformity with section 534(h) of the act (21 U.S.C. 360kk(h)). Merchandise refused admission shall be destroyed or exported under regulations prescribed by the Secretary of the Treasury unless a timely and adequate petition for permission to bring the product into compliance is filed and granted under §§1005.21 and 1005.22.

[69 FR 11314, Mar. 10, 2004]

**Subpart B—Inspection and Testing**

**Subpart C—Bonding and Compliance Procedures**

**§ 1005.10 Notice of sampling.**

When a sample of a product to be offered for importation has been requested by the Secretary, the District Director of Customs having jurisdiction over the shipment shall, upon the arrival of the shipment, procure the sample and shall give to its owner or consignee prompt notice of the delivery or of the intention to deliver such sample to the Secretary. If the notice so requires, the owner or consignee will hold the shipment of which the sample is typical and not release such shipment until he receives notice of the results of the tests of the sample from the Secretary, stating that the product is in compliance with the requirements of the Act. The District Director of Customs will be given the results of the tests. If the Secretary notifies the District Director of Customs that the product does not meet the requirements of the Act, the District Director of Customs shall require the exportation or destruction of the shipment in accordance with customs laws.

**§ 1005.11 Payment for samples.**

The Department of Health and Human Services will pay for all import samples of electronic products rendered unsalable as a result of testing, or will pay the reasonable costs of repackaging such samples for sale, if the samples are found to be in compliance with the requirements of Subchapter C—Electronic Product Radiation Control of the Federal Food, Drug, and Cosmetic Act (formerly the Radiation Control for Health and Safety Act of 1968). Billing for reimbursement shall be made by the owner or consignee to the Center for Devices and Radiological Health, 5600 Fishers Lane, Rockville, MD 20857. Payment for samples will not be made if the sample is found to be in violation of the Act, even though subsequently brought into compliance pursuant to terms specified in a notice of permission issued under § 1005.22.

[73 FR 34860, June 19, 2008]

**§ 1005.20 Hearing.**

(a) If, from an examination of the sample or otherwise, it appears that the product may be subject to a refusal of admission, the Secretary shall give the owner or consignee a written notice to that effect, stating the reasons therefor. The notice shall specify a place and a period of time during which the owner or consignee shall have an opportunity to introduce testimony unless the owner or consignee indicates his intention to bring the product into compliance. Upon timely request, such time and place may be changed. Such testimony shall be confined to matters relevant to the admissibility of the article and may be introduced orally or in writing.

(b) If the owner or consignee submits or indicates his intention to submit an application for permission to perform such action as is necessary to bring the product into compliance with the Act, such application shall include the information required by § 1005.21.

(c) If the application is not submitted at or prior to the hearing, the Secretary may allow a reasonable time for filing such application.

**§ 1005.21 Application for permission to bring product into compliance.**

Application for permission to perform such action as is necessary to bring the product into compliance with the Act may be filed only by the owner, consignee, or manufacturer and, in addition to any other information which the Secretary may reasonably require, shall:

(a) Contain a detailed proposal for bringing the product into compliance with the Act;

(b) Specify the time and place where such operations will be effected and the approximate time for their completion; and

(c) Identify the bond required to be filed pursuant to § 1005.23.

**§ 1005.22 Granting permission to bring product into compliance.**

(a) When permission contemplated by § 1005.21 is granted, the Secretary shall

notify the applicant in writing, specifying:

- (1) The procedure to be followed;
- (2) The disposition of the rejected articles or portions thereof;
- (3) That the operations are to be carried out under the supervision of a representative of the Department of Health and Human Services;
- (4) A reasonable time limit for completing the operations; and
- (5) Such other conditions as he finds necessary to maintain adequate supervision and control over the product.

(b) Upon receipt of a written request for an extension of time to complete the operations necessary to bring the product into compliance, the Secretary may grant such additional time as he deems necessary.

(c) The notice of permission may be amended upon a showing of reasonable grounds thereof and the filing of an amended application for permission with the Secretary.

(d) If ownership of a product included in a notice of permission changes before the operations specified in the notice have been completed, the original owner will remain responsible under its bond, unless the new owner has executed a superseding bond on customs Form 7601 and obtained a new notice.

(e) The Secretary will notify the District Director of Customs having jurisdiction over the shipment involved, of the determination as to whether or not the product has in fact been brought into compliance with the Act.

**§ 1005.23 Bonds.**

The bond required under section 360(b) of the Act shall be executed by the owner or consignee on the appropriate form of a customs single-entry bond, customs Form 7551 or term bond, customs Form 7553 or 7595, containing a condition for the redelivery of the shipment or any part thereof not complying with the laws and regulations governing its admission into the commerce of the United States upon demand of the District Director of Customs and containing a provision for the performance of any action necessary to bring the product into compliance with all applicable laws and regulations. The bond shall be filed with the District Director of Customs.

**§ 1005.24 Costs of bringing product into compliance.**

The costs of supervising the operations necessary to bring a product into compliance with the Act shall be paid by the owner or consignee who files an application pursuant to § 1005.21 and executes a bond under section 360(b) of the Act. Such costs shall include:

(a) Travel expenses of the supervising officer;

(b) Per diem in lieu of subsistence of the supervising officer when away from his home station, as provided by law;

(c) *Service fees:* (1) The charge for the services of the supervising officer, which shall include administrative support, shall be computed at a rate per hour equal to 266 percent of the hourly rate of regular pay of a grade GS-11/4 employee, except that such services performed by a customs officer and subject to the provisions of the act of February 13, 1911, as amended (sec. 5, 36 Stat. 901, as amended (19 U.S.C. 267)), shall be calculated as provided in that act.

(2) The charge for the services of the analyst, which shall include administrative and laboratory support, shall be computed at a rate per hour equal to 266 percent of the hourly rate of regular pay of a grade GS-12/4 employee.

(3) The rate per hour equal to 266 percent of the equivalent hourly rate of regular pay of the supervising officer (GS-11/4) and the analyst (GS-12/4) is computed as follows:

	Hours
Gross number of working hours in 52 40-hour weeks .....	2,080
Less:	
Nine legal public holidays—New Years Day, Washington's Birthday, Memorial Day, Independence Day, Labor Day, Columbus Day, Veterans Day, Thanksgiving Day, and Christmas Day .....	72
Annual Leave—26 days .....	208
Sick Leave—13 days .....	104
Total .....	384
Net number of working hours .....	1,696
Gross number of working hours in 52 40-hour weeks .....	2,080
Working hour equivalent of Government contributions for employee retirement, life insurance, and health benefits computed at 8½% of annual rate of pay of employee .....	176
Equivalent annual working hours .....	2,256

**§ 1005.25**

**21 CFR Ch. I (4–1–20 Edition)**

	Hours
Support required to equal to 1 man-year .....	2,256
Equivalent gross annual working hours charged to Food and Drug appropriation .....	4,512

NOTE: Ratio of equivalent gross annual number of working hours charged to Food and Drug appropriation to net number of annual working hours (4512/1696) = 266 pct.

(d) The minimum charge for services of supervising officers shall be not less than the charge for 1 hour and time after the first hour shall be computed in multiples of 1 hour, disregarding fractional parts less than one-half hour.

[38 FR 28630, Oct. 15, 1973, as amended at 42 FR 55207, Oct. 14, 1977; 42 FR 62130, Dec. 9, 1977]

**§ 1005.25 Service of process on manufacturers.**

(a) Every manufacturer of electronic products, prior to offering such product for importation into the United States, shall designate a permanent resident of the United States as the manufacturer's agent upon whom service of all processes, notices, orders, decisions, and requirements may be made for and on behalf of the manufacturer as provided in section 536(d) of Subchapter C—Electronic Product Radiation Control of the Federal Food, Drug, and Cosmetic Act (formerly the Radiation Control for Health and Safety Act of 1968) (21 U.S.C. 360mm(d)) and this section. The agent may be an individual, a firm, or a domestic corporation. For purposes of this section, any number of manufacturers may designate the same agent.

(b) A manufacturer designating an agent must address the designation to the Center for Devices and Radiological Health, 10903 New Hampshire Ave., Document Mail Center—WO66-G609, Silver Spring, MD 20993-0002. It must be in writing and dated; all signatures must be in ink. The designation must be made in the legal form required to make it valid and binding on the manufacturer under the laws, corporate bylaws, or other requirements governing the making of the designation by the manufacturer at the place and time where it is made, and the persons or person signing the designation

shall certify that it is so made. The designation must disclose the manufacturer's full legal name and the name(s) under which the manufacturer conducts the business, if applicable, the principal place of business, and mailing address. If any of the products of the manufacturer do not bear his legal name, the designation must identify the marks, trade names, or other designations of origin which these products bear. The designation must provide that it will remain in effect until withdrawn or replaced by the manufacturer and shall bear a declaration of acceptance duly signed by the designated agent. The full legal name and mailing address of the agent must be stated. Until rejected by the Secretary, designations are binding on the manufacturer even when not in compliance with all the requirements of this section. The designated agent may not assign performance of his function under the designation to another.

(c) Service of any process, notice, order, requirement, or decision specified in section 536(d) of Subchapter C—Electronic Product Radiation Control of the Federal Food, Drug, and Cosmetic Act (formerly the Radiation Control for Health and Safety Act of 1968) (21 U.S.C. 360mm(d)) may be made by registered or certified mail addressed to the agent with return receipt requested, or in any other manner authorized by law. In the absence of such a designation or if for any reason service on the designated agent cannot be effected, service may be made as provided in section 536(d) by posting such process, notice, order, requirement, or decision in the Office of the Director, Center for Devices and Radiological Health and publishing a notice that such service was made in the FEDERAL REGISTER.

[38 FR 28630, Oct. 15, 1973, as amended at 53 FR 11254, Apr. 6, 1988; 65 FR 17137, Mar. 31, 2000; 72 FR 17401, Apr. 9, 2007; 73 FR 34860, June 19, 2008; 75 FR 16353, Apr. 1, 2010; 78 FR 18234, Mar. 26, 2013]

**PART 1010—PERFORMANCE STANDARDS FOR ELECTRONIC PRODUCTS: GENERAL**

**Subpart A—General Provisions**

- Sec.
- 1010.1 Scope.
- 1010.2 Certification.
- 1010.3 Identification.
- 1010.4 Variances.
- 1010.5 Exemptions for products intended for United States Government use.

**Subpart B—Alternate Test Procedures**

- 1010.13 Special test procedures.

**Subpart C—Exportation of Electronic Products**

- 1010.20 Electronic products intended for export.

AUTHORITY: 21 U.S.C. 351, 352, 360, 360e-360j, 360hh-360ss, 371, 381.

SOURCE: 38 FR 28631, Oct. 15, 1973, unless otherwise noted.

**Subpart A—General Provisions**

**§ 1010.1 Scope.**

The standards listed in this subchapter are prescribed pursuant to section 534 of Subchapter C—Electronic Product Radiation Control of the Federal Food, Drug, and Cosmetic Act (formerly the Radiation Control for Health and Safety Act of 1968) (21 U.S.C. 360kk) and are applicable to electronic products as specified herein, to control electronic product radiation from such products. Standards so prescribed are subject to amendment or revocation and additional standards may be prescribed as are determined necessary for the protection of the public health and safety.

[73 FR 34861, June 19, 2008]

**§ 1010.2 Certification.**

(a) Every manufacturer of an electronic product for which an applicable standard is in effect under this subchapter shall furnish to the dealer or distributor, at the time of delivery of such product, the certification that such product conforms to all applicable standards under this subchapter.

(b) The certification shall be in the form of a label or tag permanently af-

fixed to or inscribed on such product so as to be legible and readily accessible to view when the product is fully assembled for use, unless the applicable standard prescribes some other manner of certification. All such labels or tags shall be in the English language.

(c) Such certification shall be based upon a test, in accordance with the standard, of the individual article to which it is attached or upon a testing program which is in accordance with good manufacturing practices. The Director, Center for Devices and Radiological Health may disapprove such a testing program on the grounds that it does not assure the adequacy of safeguards against hazardous electronic product radiation or that it does not assure that electronic products comply with the standards prescribed under this subchapter.

(d) In the case of products for which it is not feasible to certify in accordance with paragraph (b) of this section, upon application by the manufacturer, the Director, Center for Devices and Radiological Health may approve an alternate means by which such certification may be provided.

[38 FR 28631, Oct. 15, 1973, as amended at 40 FR 32257, July 31, 1975; 42 FR 18063, Apr. 5, 1977; 53 FR 11254, Apr. 6, 1988]

**§ 1010.3 Identification.**

(a) Every manufacturer of an electronic product to which a standard under this subchapter is applicable shall set forth the information specified in paragraphs (a)(1) and (2) of this section. This information shall be provided in the form of a tag or label permanently affixed or inscribed on such product so as to be legible and readily accessible to view when the product is fully assembled for use or in such other manner as may be prescribed in the applicable standard. Except for foreign equivalent abbreviations as authorized in paragraph (a)(1) of this section all such labels or tags shall be in the English language.

(1) The full name and address of the manufacturer of the product; abbreviations such as “Co.,” “Inc.,” or their foreign equivalents and the first and middle initials of individuals may be used. Where products are sold under a

#### § 1010.4

#### 21 CFR Ch. I (4-1-20 Edition)

name other than that of the manufacturer of the product, the full name and address of the individual or company under whose name the product was sold may be set forth, provided such individual or company has previously supplied the Director, Center for Devices and Radiological Health with sufficient information to identify the manufacturer of the product.

(2) The place and month and year of manufacture:

(i) The place of manufacture may be expressed in code provided the manufacturer has previously supplied the Director, Center for Devices and Radiological Health with the key to such code.

(ii) The month and year of manufacture shall be provided clearly and legibly, without abbreviation, and with the year shown as a four-digit number as follows:

MANUFACTURED: (INSERT MONTH AND YEAR OF MANUFACTURE.)

(b) In the case of products for which it is not feasible to affix identification labeling in accordance with paragraph (a) of this section, upon application by the manufacturer, the Director, Center for Devices and Radiological Health may approve an alternate means by which such identification may be provided.

(c) Every manufacturer of an electronic product to which a standard under this subchapter is applicable shall provide to the Director, Center for Devices and Radiological Health a list identifying each brand name which is applied to the product together with the full name and address of the individual or company for whom each product so branded is manufactured.

[40 FR 32257, July 31, 1975, as amended at 42 FR 18063, Apr. 5, 1977; 53 FR 11254, Apr. 6, 1988]

#### § 1010.4 Variances.

(a) *Criteria for variances.* (1) Upon application by a manufacturer (including an assembler), the Director, Center for Devices and Radiological Health, Food and Drug Administration, may grant a variance from one or more provisions of any performance standard under subchapter J of this chapter for an electronic product subject to such

standard when the Director determines that granting such a variance is in keeping with the purposes of Subchapter C—Electronic Product Radiation Control of the Federal Food, Drug, and Cosmetic Act (formerly the Radiation Control for Health and Safety Act of 1968), and:

(i) The scope of the requested variance is so limited in its applicability as not to justify an amendment to the standard, or

(ii) There is not sufficient time for the promulgation of an amendment to the standard.

(2) The issuance of the variance shall be based upon a determination that:

(i) The product utilizes an alternate means for providing radiation safety or protection equal to or greater than that provided by products meeting all requirements of the applicable standard, or

(ii) The product performs a function or is intended for a purpose which could not be performed or accomplished if required to meet the applicable standards, and suitable means for assuring radiation safety or protection are provided, or

(iii) One or more requirements of the applicable standard are not appropriate, and suitable means for assuring radiation safety or protection are provided.

(b) *Applications for variances.* If you are submitting an application for variances or for amendments or extensions thereof, you must submit an original and two copies to the Division of Dockets Management (HFA-305), Food and Drug Administration, 5630 Fishers Lane, rm. 1061, Rockville, MD 20852.

(1) The application for variance shall include the following information:

(i) A description of the product and its intended use.

(ii) An explanation of how compliance with the applicable standard would restrict or be inappropriate for this intended use.

(iii) A description of the manner in which it is proposed to deviate from the requirements of the applicable standard.

(iv) A description of the advantages to be derived from such deviation.

(v) An explanation of how alternate or suitable means of radiation protection will be provided.

(vi) The period of time it is desired that the variance be in effect, and, if appropriate, the number of units the applicant wishes to manufacture.

(vii) In the case of prototype or experimental equipment, the proposed location of each unit.

(viii) Such other information required by regulation or by the Director, Center for Devices and Radiological Health, to evaluate and act on the application.

(ix) With respect to each nonclinical laboratory study contained in the application, either a statement that the study was conducted in compliance with the good laboratory practice regulations set forth in part 58 of this chapter, or, if the study was not conducted in compliance with such regulations, a brief statement of the reason for the noncompliance.

(x) [Reserved]

(xi) If the electronic product is used in a clinical investigation involving human subjects, is subject to the requirements for institutional review set forth in part 56 of this chapter, and is subject to the requirements for informed consent set forth in part 50 of this chapter, the investigation shall be conducted in compliance with such requirements.

(2) The application for amendment or extension of a variance shall include the following information:

(i) The variance number and expiration date.

(ii) The amendment or extension requested and basis for the amendment or extension.

(iii) A description of the effect of the amendment or extension on protection from radiation produced by the product.

(iv) An explanation of how alternate or suitable means of protection will be provided.

(c) *Ruling on applications.* (1) The Director, Center for Devices and Radiological Health, may approve or deny, in whole or in part, a requested variance or any amendment or extension thereof, and the director shall inform the applicant in writing of this action on a requested variance or amendment or

extension. The written notice will state the manner in which the variance differs from the standard, the effective date and the termination date of the variance, a summary of the requirements and conditions attached to the variance, any other information that may be relevant to the application or variance, and, if appropriate, the number of units or other similar limitations for which the variance is approved. Each variance will be assigned an identifying number.

(2) The Director, Center for Devices and Radiological Health, shall amend or withdraw a variance whenever the Director determines that this action is necessary to protect the public health or otherwise is justified by this subchapter. Such action will become effective on the date specified in the written notice of the action sent to the applicant, except that it will become effective immediately upon notification to the applicant when the Director determines that such action is necessary to prevent an imminent health hazard.

(3) All applications for variances and for amendments and extensions thereof and all correspondence (including written notices of approval) on these applications will be available for public disclosure in the office of the Division of Dockets Management, except for information regarded as confidential under section 537(e) of the act.

(d) *Certification of equipment covered by variance.* The manufacturer of any product for which a variance is granted shall modify the tag, label, or other certification required by §1010.2 to state:

(1) That the product is in conformity with the applicable standard, except with respect to those characteristics covered by the variance;

(2) That the product is in conformity with the provisions of the variance; and

(3) The assigned number and effective date of the variance.

[39 FR 13879, Apr. 18, 1974, as amended at 44 FR 48191, Aug. 17, 1979; 50 FR 7518, Feb. 22, 1985; 50 FR 13565, Apr. 5, 1985; 53 FR 11254, Apr. 6, 1988; 53 FR 52683, Dec. 29, 1988; 59 FR 14365, Mar. 28, 1994; 65 FR 17137, Mar. 31, 2000; 73 FR 34861, June 19, 2008; 75 FR 16353, Apr. 1, 2010]

**§ 1010.5 Exemptions for products intended for United States Government use.**

(a) *Criteria for exemption.* Upon application by a manufacturer (including assembler) or by a U.S. department or agency, the Director, Center for Devices and Radiological Health, Food and Drug Administration, may grant an exemption from any performance standard under subchapter J of this chapter for an electronic product, or class of products, otherwise subject to such standard when he determines that such electronic product or class is intended for use by departments or agencies of the United States and meets the criteria set forth in paragraph (a) (1) or (2) of this section.

(1) The procuring agency shall prescribe procurement specifications for the product or class of products governing emissions of electronic product radiation, and the product or class shall be of a type used solely or predominantly by a department or agency of the United States.

(2) The product or class of products is intended for research, investigations, studies, demonstration, or training, or for reasons of national security.

(b) *Consultation between the procuring agency and the Food and Drug Administration.* The United States department or agency that intends to procure or manufacture a product or class of products subject to electronic product radiation safety standards contained in this subchapter should consult with the Center for Devices and Radiological Health, Food and Drug Administration, whenever it is anticipated that the specifications for the product or class must deviate from, or be in conflict with, such applicable standards. Such consultation should occur as early as possible during development of such specifications. The department or agency should include in the specifications all requirements of such standards that are not in conflict with, or are not inappropriate for, the special or unique uses for which the product is intended. The procuring agency should indicate to the Center for Devices and Radiological Health if it desires to be notified of the approval, amendment, or withdrawal of the exemption.

(c) *Application for exemption.* If you are submitting an application for exemption, or for amendment or extension thereof, you must submit an original and two copies to the Division of Dockets Management (HFA-305), Food and Drug Administration, 5630 Fishers Lane, rm. 1061, Rockville, MD 20852. For an exemption under the criteria prescribed in paragraph (a)(1) of this section, the application shall include the information prescribed in paragraphs (c)(1) through (c)(13) of this section. For an exemption under the criteria prescribed in paragraph (a)(2) of this section, the application shall include the information prescribed in paragraphs (c)(3) through (c)(13) of this section. An application for exemption, or for amendment or extension thereof, and correspondence relating to such application shall be made available for public disclosure in the Division of Dockets Management, except for confidential or proprietary information submitted in accordance with part 20 of this chapter. Information classified for reasons of national security shall not be included in the application. Except as indicated in this paragraph, the application for exemption shall include the following:

(1) The procurement specifications for the product or class of products that govern emissions of electronic product radiation.

(2) Evidence that the product or class of products is of a type used solely or predominantly by departments or agencies of the United States.

(3) Evidence that such product or class of products is intended for use by a department or agency of the United States.

(4) A description of the product or class of products and its intended use.

(5) An explanation of how compliance with the applicable standard would restrict or be inappropriate for this intended use.

(6) A description of the manner in which it is proposed that the product or class of products shall deviate from the requirements of the applicable standard.

(7) An explanation of the advantages to be derived from such deviation.

(8) An explanation of how means of radiation protection will be provided



where the product or class of products deviates from the requirements of the applicable standard.

(9) The period of time it is desired that the exemption be in effect, and, if appropriate, the number of units to be manufactured under the exemption.

(10) The name, address, and telephone number of the manufacturer or his agent.

(11) The name, address, and telephone number of the appropriate office of the United States department or agency purchasing the product or class of products.

(12) Such other information required by regulation or by the Director, Center for Devices and Radiological Health, to evaluate and act on the application. Where such information includes nonclinical laboratory studies, the information shall include, with respect to each nonclinical study, either a statement that each study was conducted in compliance with the requirements set forth in part 58 of this chapter, or, if the study was not conducted in compliance with such regulations, a statement that describes in detail all differences between the practices used in the study and those required in the regulations. When such information includes clinical investigations involving human subjects, the information shall include, with respect to each clinical investigation, either a statement that each investigation was conducted in compliance with the requirements set forth in part 56 of this chapter, or a statement that the investigation is not subject to such requirements in accordance with § 56.104 or § 56.105 and a statement that each investigation was conducted in compliance with the requirements set forth in part 50 of this chapter.

(13) With respect to each nonclinical laboratory study contained in the application, either a statement that the study was conducted in compliance with the requirements set forth in part 58 of this chapter, or, if the study was not conducted in compliance with such regulations, a brief statement of the reason for the noncompliance.

(d) *Amendment or extension of an exemption.* An exemption is granted on the basis of the information contained in the original application. Therefore, if

changes are needed in the radiation safety specifications for the product, or its use, or related radiation control procedures such that the information in the original application would no longer be correct with respect to radiation safety, the applicant shall submit in advance of such changes a request for an amendment to the exemption. He also shall submit a request for extension of the exemption, if needed, at least 60 days before the expiration date. The application for amendment or extension of an exemption shall include the following information:

(1) The exemption number and expiration date.

(2) The amendment or extension requested and basis for the amendment or extension.

(3) If the radiation safety specifications for the product or class of products or the product's or class of products' use or related radiation control procedures differ from the description provided in the original application, a description of such changes.

(e) *Ruling on an application.* (1) The Director, Center for Devices and Radiological Health, may grant an exemption including in the written notice of exemption such conditions or terms as may be necessary to protect the public health and safety and shall notify the applicant in writing of his action. The conditions or terms of the exemption may include specifications concerning the manufacture, use, control, and disposal of the excess or surplus exempted product or class of products as provided in the Code of Federal Regulations, title 41, subtitle C. Each exemption will be assigned an identifying number.

(2) The Director, Center for Devices and Radiological Health, shall amend or withdraw an exemption whenever he determines that such action is necessary to protect the public health or otherwise is justified by provisions of the act or this subchapter. Such action shall become effective on the date specified in the written notice of the action sent to the applicant, except that it shall become effective immediately when the Director determines that it is necessary to prevent an imminent health hazard.

(f) *Identification of equipment covered by exemption.* The manufacturer of any

## § 1010.13

product for which an exemption is granted shall provide the following identification in the form of a tag or label permanently affixed or inscribed on such product so as to be legible and readily accessible to view when the product is fully assembled for use or in such other manner as may be prescribed in the exemption:

### CAUTION

This electronic product has been exempted from Food and Drug Administration radiation safety performance standards prescribed in the Code of Federal Regulations, title 21, chapter I, subchapter J, pursuant to Exemption No. \_\_\_\_\_, granted on

[42 FR 44229, Sept. 2, 1977; 42 FR 61257, Dec. 2, 1977, as amended at 44 FR 17657, Mar. 23, 1979; 46 FR 8460, 8958, Jan. 27, 1981; 50 FR 7518, Feb. 22, 1985; 50 FR 13564, Apr. 5, 1985; 53 FR 11254, Apr. 6, 1988; 59 FR 14365, Mar. 28, 1994; 65 FR 17138, Mar. 31, 2000]

### Subpart B—Alternate Test Procedures

#### § 1010.13 Special test procedures.

The Director, Center for Devices and Radiological Health, may, on the basis of a written application by a manufacturer, authorize test programs other than those set forth in the standards under this subchapter for an electronic product if he determines that such products are not susceptible to satisfactory testing by the procedures set forth in the standard and that the alternative test procedures assure compliance with the standard.

[40 FR 32257, July 31, 1975, as amended at 53 FR 11254, Apr. 6, 1988]

### Subpart C—Exportation of Electronic Products

#### § 1010.20 Electronic products intended for export.

The performance standards prescribed in this subchapter shall not apply to any electronic product which is intended solely for export if:

(a) Such product and the outside of any shipping container used in the export of such product are labeled or tagged to show that such product is intended for export, and

## 21 CFR Ch. I (4–1–20 Edition)

(b) Such product meets all the applicable requirements of the country to which such product is intended for export.

[40 FR 32257, July 31, 1975]

## PART 1020—PERFORMANCE STANDARDS FOR IONIZING RADIATION EMITTING PRODUCTS

### Sec.

- 1020.10 Television receivers.
- 1020.20 Cold-cathode gas discharge tubes.
- 1020.30 Diagnostic x-ray systems and their major components.
- 1020.31 Radiographic equipment.
- 1020.32 Fluoroscopic equipment.
- 1020.33 Computed tomography (CT) equipment.
- 1020.40 Cabinet x-ray systems.

AUTHORITY: 21 U.S.C. 351, 352, 360e–360j, 360hh–360ss, 371, 381.

SOURCE: 38 FR 28632, Oct. 15, 1973, unless otherwise noted.

#### § 1020.10 Television receivers.

(a) *Applicability.* The provisions of this section are applicable to television receivers manufactured subsequent to January 15, 1970.

(b) *Definitions.* (1) *External surface* means the cabinet or enclosure provided by the manufacturer as part of the receiver. If a cabinet or enclosure is not provided as part of the receiver, the external surface shall be considered to be a hypothetical cabinet, the plane surfaces of which are located at those minimum distances from the chassis sufficient to enclose all components of the receiver except that portion of the neck and socket of the cathode-ray tube which normally extends beyond the plane surfaces of the enclosure.

(2) *Maximum test voltage* means 130 root mean square volts if the receiver is designed to operate from nominal 110 to 120 root mean square volt power sources. If the receiver is designed to operate from a power source having some voltage other than from nominal 110 to 120 root mean square volts, maximum test voltage means 110 percent of the nominal root mean square voltage specified by the manufacturer for the power source.

(3) *Service controls* means all of those controls on a television receiver provided by the manufacturer for purposes

of adjustment which, under normal usage, are not accessible to the user.

(4) *Television receiver* means an electronic product designed to receive and display a television picture through broadcast, cable, or closed circuit television.

(5) *Usable picture* means a picture in synchronization and transmitting viewable intelligence.

(6) *User controls* means all of those controls on a television receiver, provided by the manufacturer for purposes of adjustment, which on a fully assembled receiver under normal usage, are accessible to the user.

(c) *Requirements*—(1) *Exposure rate limit*. Radiation exposure rates produced by a television receiver shall not exceed 0.5 milliroentgens per hour at a distance of five (5) centimeters from any point on the external surface of the receiver, as measured in accordance with this section.

(2) *Measurements*. Compliance with the exposure rate limit defined in paragraph (c)(1) of this section shall be determined by measurements made with an instrument, the radiation sensitive volume of which shall have a cross section parallel to the external surface of the receiver with an area of ten (10) square centimeters and no dimension larger than five (5) centimeters. Measurements made with instruments having other areas must be corrected for spatial nonuniformity of the radiation field to obtain the exposure rate average over a ten (10) square centimeter area.

(3) *Test conditions*. All measurements shall be made with the receiver displaying a usable picture and with the power source operated at supply voltages up to the maximum test voltage of the receiver and, as applicable, under the following specific conditions:

(i) On television receivers manufactured subsequent to January 15, 1970, measurements shall be made with all user controls adjusted so as to produce maximum x-radiation emissions from the receiver.

(ii) On television receivers manufactured subsequent to June 1, 1970, measurements shall be made with all user controls and all service controls adjusted to combinations which result in

the production of maximum x-radiation emissions.

(iii) On television receivers manufactured subsequent to June 1, 1971, measurements shall be made under the conditions described in paragraph (c)(3) (ii) of this section, together with conditions identical to those which result from that component or circuit failure which maximizes x-radiation emissions.

(4) *Critical component warning*. The manufacturer shall permanently affix or inscribe a warning label, clearly legible under conditions of service, on all television receivers which could produce radiation exposure rates in excess of the requirements of this section as a result of failure or improper adjustment or improper replacement of a circuit or shield component. The warning label shall include the specification of operating high voltage and an instruction for adjusting the high voltage to the specified value.

#### § 1020.20 Cold-cathode gas discharge tubes.

(a) *Applicability*. The provisions of this section are applicable to cold-cathode gas discharge tubes designed to demonstrate the effects of a flow of electrons or the production of x-radiation as specified herein.

(b) *Definitions*. *Beam blocking device* means a movable or removable portion of any enclosure around a cold-cathode gas discharge tube, which may be opened or closed to permit or prevent the emergence of an exit beam.

*Cold-cathode gas discharge tube* means an electronic device in which electron flow is produced and sustained by ionization of contained gas atoms and ion bombardment of the cathode.

*Exit beam* means that portion of the radiation which passes through the aperture resulting from the opening of the beam blocking device.

*Exposure* means the sum of the electrical charges on all of the ions of one sign produced in air when all electrons liberated by photons in a volume element of air are completely stopped in air divided by the mass of the air in the volume element. The special unit of exposure is the roentgen. One (1) roentgen equals  $2.58 \times 10^{-4}$  coulombs/kilogram.

(c) *Requirements*—(1) *Exposure rate limit.* (i) Radiation exposure rates produced by cold-cathode gas discharge tubes shall not exceed 10 mR./hr. at a distance of thirty (30) centimeters from any point on the external surface of the tube, as measured in accordance with this section.

(ii) The divergence of the exit beam from tubes designed primarily to demonstrate the effects of x radiation, with the beam blocking device in the open position, shall not exceed ( $\pi$ ) steradians.

(2) *Measurements.* (i) Compliance with the exposure rate limit defined in paragraph (c)(1)(i) of this section shall be determined by measurements averaged over an area of one hundred (100) square centimeters with no linear dimension greater than twenty (20) centimeters.

(ii) Measurements of exposure rates from tubes in enclosures from which the tubes cannot be removed without destroying the function of the tube may be made at a distance of thirty (30) centimeters from any point on the external surface of the enclosure, provided:

(a) In the case of enclosures containing tubes designed primarily to demonstrate the production of x radiation, measurements shall be made with any beam blocking device in the beam blocking position, or

(b) In the case of enclosures containing tubes designed primarily to demonstrate the effects of a flow of electrons, measurements shall be made with all movable or removable parts of such enclosure in the position which would maximize external exposure levels.

(3) *Test conditions.* (i) Measurements shall be made under the conditions of use specified in instructions provided by the manufacturer.

(ii) Measurements shall be made with the tube operated under forward and reverse polarity.

(4) *Instructions, labels, and warnings.* (i) Manufacturers shall provide, or cause to be provided, with each tube to which this section is applicable, appropriate safety instructions, together with instructions for the use of such tube, including the specification of a power source for use with the tube.

(ii) Each enclosure or tube shall have inscribed on or permanently affixed to it, tags or labels, which identify the intended polarity of the terminals and:

(a) In the case of tubes designed primarily to demonstrate the heat effect, fluorescence effect, or magnetic effect, a warning that application of power in excess of that specified may result in the production of x-rays in excess of allowable limits; and (b) in the case of tubes designed primarily to demonstrate the production of x-radiation, a warning that this device produces x-rays when energized.

(iii) The tag or label required by this paragraph shall be located on the tube or enclosure so as to be readily visible and legible when the product is fully assembled for use.

#### § 1020.30 Diagnostic x-ray systems and their major components.

(a) *Applicability.* (1) The provisions of this section are applicable to:

(i) The following components of diagnostic x-ray systems:

(A) Tube housing assemblies, x-ray controls, x-ray high-voltage generators, x-ray tables, cradles, film changers, vertical cassette holders mounted in a fixed location and cassette holders with front panels, and beam-limiting devices manufactured after August 1, 1974.

(B) Fluoroscopic imaging assemblies manufactured after August 1, 1974, and before April 26, 1977, or after June 10, 2006.

(C) Spot-film devices and image intensifiers manufactured after April 26, 1977.

(D) Cephalometric devices manufactured after February 25, 1978.

(E) Image receptor support devices for mammographic x-ray systems manufactured after September 5, 1978.

(F) Image receptors that are electrically powered or connected with the x-ray system manufactured on or after June 10, 2006.

(G) Fluoroscopic air kerma display devices manufactured on or after June 10, 2006.

(ii) Diagnostic x-ray systems, except computed tomography x-ray systems, incorporating one or more of such components; however, such x-ray systems shall be required to comply only with

those provisions of this section and §§ 1020.31 and 1020.32, which relate to the components certified in accordance with paragraph (c) of this section and installed into the systems.

(iii) Computed tomography (CT) x-ray systems manufactured before November 29, 1984.

(iv) CT gantries manufactured after September 3, 1985.

(2) The following provisions of this section and § 1020.33 are applicable to CT x-ray systems manufactured or remanufactured on or after November 29, 1984:

(i) Section 1020.30(a);

(ii) Section 1020.30(b) "Technique factors";

(iii) Section 1020.30(b) "CT," "Dose," "Scan," "Scan time," and "Tomogram";

(iv) Section 1020.30(h)(3)(vi) through (h)(3)(viii);

(v) Section 1020.30(n);

(vi) Section 1020.33(a) and (b);

(vii) Section 1020.33(c)(1) as it affects § 1020.33(c)(2); and

(viii) Section 1020.33(c)(2).

(3) The provisions of this section and § 1020.33 in its entirety, including those provisions in paragraph (a)(2) of this section, are applicable to CT x-ray systems manufactured or remanufactured on or after September 3, 1985. The date of manufacture of the CT system is the date of manufacture of the CT gantry.

(b) *Definitions.* As used in this section and §§ 1020.31, 1020.32, and 1020.33, the following definitions apply:

*Accessible surface* means the external surface of the enclosure or housing provided by the manufacturer.

*Accessory component* means:

(1) A component used with diagnostic x-ray systems, such as a cradle or film changer, that is not necessary for the compliance of the system with applicable provisions of this subchapter but which requires an initial determination of compatibility with the system; or

(2) A component necessary for compliance of the system with applicable provisions of this subchapter but which may be interchanged with similar compatible components without affecting the system's compliance, such as one of a set of interchangeable beam-limiting devices; or

(3) A component compatible with all x-ray systems with which it may be used and that does not require compatibility or installation instructions, such as a tabletop cassette holder.

*Air kerma* means kerma in air (see definition of *Kerma*).

*Air kerma rate (AKR)* means the air kerma per unit time.

*Aluminum equivalent* means the thickness of aluminum (type 1100 alloy)<sup>1</sup> affording the same attenuation, under specified conditions, as the material in question.

*Articulated joint* means a joint between two separate sections of a tabletop which joint provides the capacity for one of the sections to pivot on the line segment along which the sections join.

*Assembler* means any person engaged in the business of assembling, replacing, or installing one or more components into a diagnostic x-ray system or subsystem. The term includes the owner of an x-ray system or his or her employee or agent who assembles components into an x-ray system that is subsequently used to provide professional or commercial services.

*Attenuation block* means a block or stack of type 1100 aluminum alloy, or aluminum alloy having equivalent attenuation, with dimensions 20 centimeters (cm) or larger by 20 cm or larger by 3.8 cm, that is large enough to intercept the entire x-ray beam.

*Automatic exposure control (AEC)* means a device which automatically controls one or more technique factors in order to obtain at a preselected location(s) a required quantity of radiation.

*Automatic exposure rate control (AERC)* means a device which automatically controls one or more technique factors in order to obtain at a preselected location(s) a required quantity of radiation per unit time.

*Beam axis* means a line from the source through the centers of the x-ray fields.

<sup>1</sup>The nominal chemical composition of type 1100 aluminum alloy is 99.00 percent minimum aluminum, 0.12 percent copper, as given in "Aluminum Standards and Data" (1969). Copies may be obtained from The Aluminum Association, New York, NY.

*Beam-limiting device* means a device which provides a means to restrict the dimensions of the x-ray field.

*C-arm fluoroscope* means a fluoroscopic x-ray system in which the image receptor and the x-ray tube housing assembly are connected or coordinated to maintain a spatial relationship. Such a system allows a change in the direction of the beam axis with respect to the patient without moving the patient.

*Cantilevered tabletop* means a tabletop designed such that the unsupported

portion can be extended at least 100 cm beyond the support.

*Cassette holder* means a device, other than a spot-film device, that supports and/or fixes the position of an x-ray film cassette during an x-ray exposure.

*Cephalometric device* means a device intended for the radiographic visualization and measurement of the dimensions of the human head.

*Coefficient of variation* means the ratio of the standard deviation to the mean value of a population of observations. It is estimated using the following equation:

$$C = \frac{s}{\bar{X}} = \frac{1}{\bar{X}} \left[ \sum_{i=1}^n \frac{(X_i - \bar{X})^2}{n-1} \right]^{1/2}$$

where:

s = Estimated standard deviation of the population.

$\bar{X}$  = Mean value of observations in sample.

$X_i$  = *i*th observation sampled.

n = Number of observations sampled.

*Computed tomography (CT)* means the production of a tomogram by the acquisition and computer processing of x-ray transmission data.

*Control panel* means that part of the x-ray control upon which are mounted the switches, knobs, pushbuttons, and other hardware necessary for manually setting the technique factors.

*Cooling curve* means the graphical relationship between heat units stored and cooling time.

*Cradle* means:

(1) A removable device which supports and may restrain a patient above an x-ray table; or

(2) A device;

(i) Whose patient support structure is interposed between the patient and the image receptor during normal use;

(ii) Which is equipped with means for patient restraint; and

(iii) Which is capable of rotation about its long (longitudinal) axis.

*CT gantry* means tube housing assemblies, beam-limiting devices, detectors,

and the supporting structures, frames, and covers which hold and/or enclose these components.

*Cumulative air kerma* means the total air kerma accrued from the beginning of an examination or procedure and includes all contributions from fluoroscopic and radiographic irradiation.

*Diagnostic source assembly* means the tube housing assembly with a beam-limiting device attached.

*Diagnostic x-ray system* means an x-ray system designed for irradiation of any part of the human body for the purpose of diagnosis or visualization.

*Dose* means the absorbed dose as defined by the International Commission on Radiation Units and Measurements. The absorbed dose, D, is the quotient of *de* by *dm*, where *de* is the mean energy imparted to matter of mass *dm*; thus  $D = de/dm$ , in units of J/kg, where the special name for the unit of absorbed dose is gray (Gy).

*Equipment* means x-ray equipment.

*Exposure (X)* means the quotient of *dQ* by *dm* where *dQ* is the absolute value of the total charge of the ions of one sign produced in air when all the electrons and positrons liberated or created by photons in air of mass *dm*

are completely stopped in air; thus  $X = dQ/dm$ , in units of C/kg. A second meaning of exposure is the process or condition during which the x-ray tube produces x-ray radiation.

*Field emission equipment* means equipment which uses an x-ray tube in which electron emission from the cathode is due solely to action of an electric field.

*Fluoroscopic air kerma display device* means a device, subsystem, or component that provides the display of AKR and cumulative air kerma required by §1020.32(k). It includes radiation detectors, if any, electronic and computer components, associated software, and data displays.

*Fluoroscopic imaging assembly* means a subsystem in which x-ray photons produce a set of fluoroscopic images or radiographic images recorded from the fluoroscopic image receptor. It includes the image receptor(s), electrical interlocks, if any, and structural material providing linkage between the image receptor and diagnostic source assembly.

*Fluoroscopic irradiation time* means the cumulative duration during an examination or procedure of operator-applied continuous pressure to the device, enabling x-ray tube activation in any fluoroscopic mode of operation.

*Fluoroscopy* means a technique for generating x-ray images and presenting them simultaneously and continuously as visible images. This term has the same meaning as the term "radioscopy" in the standards of the International Electrotechnical Commission.

*General purpose radiographic x-ray system* means any radiographic x-ray system which, by design, is not limited to radiographic examination of specific anatomical regions.

*Half-value layer (HVL)* means the thickness of specified material which attenuates the beam of radiation to an extent such that the AKR is reduced to one-half of its original value. In this definition the contribution of all scattered radiation, other than any which might be present initially in the beam concerned, is deemed to be excluded.

*Image intensifier* means a device, installed in its housing, which instantaneously converts an x-ray pattern into

a corresponding light image of higher energy density.

*Image receptor* means any device, such as a fluorescent screen, radiographic film, x-ray image intensifier tube, solid-state detector, or gaseous detector, which transforms incident x-ray photons either into a visible image or into another form which can be made into a visible image by further transformations. In those cases where means are provided to preselect a portion of the image receptor, the term "image receptor" shall mean the preselected portion of the device.

*Image receptor support device* means, for mammography x-ray systems, that part of the system designed to support the image receptor during a mammographic examination and to provide a primary protective barrier.

*Isocenter* means the center of the smallest sphere through which the beam axis passes when the equipment moves through a full range of rotations about its common center.

*Kerma* means the quantity as defined by the International Commission on Radiation Units and Measurements. The kerma,  $K$ , is the quotient of  $dE_{tr}$  by  $dm$ , where  $dE_{tr}$  is the sum of the initial kinetic energies of all the charged particles liberated by uncharged particles in a mass  $dm$  of material; thus  $K = dE_{tr}/dm$ , in units of J/kg, where the special name for the unit of kerma is gray (Gy). When the material is air, the quantity is referred to as "air kerma."

*Last-image-hold (LIH) radiograph* means an image obtained either by retaining one or more fluoroscopic images, which may be temporally integrated, at the end of a fluoroscopic exposure or by initiating a separate and distinct radiographic exposure automatically and immediately in conjunction with termination of the fluoroscopic exposure.

*Lateral fluoroscope* means the x-ray tube and image receptor combination in a biplane system dedicated to the lateral projection. It consists of the lateral x-ray tube housing assembly and the lateral image receptor that are fixed in position relative to the table with the x-ray beam axis parallel to the plane of the table.

*Leakage radiation* means radiation emanating from the diagnostic source assembly except for:

- (1) The useful beam; and
- (2) Radiation produced when the exposure switch or timer is not activated.

*Leakage technique factors* means the technique factors associated with the diagnostic source assembly which are used in measuring leakage radiation. They are defined as follows:

- (1) For diagnostic source assemblies intended for capacitor energy storage equipment, the maximum-rated peak tube potential and the maximum-rated number of exposures in an hour for operation at the maximum-rated peak tube potential with the quantity of charge per exposure being 10 millicoulombs (or 10 mAs) or the minimum obtainable from the unit, whichever is larger;

- (2) For diagnostic source assemblies intended for field emission equipment rated for pulsed operation, the maximum-rated peak tube potential and the maximum-rated number of x-ray pulses in an hour for operation at the maximum-rated peak tube potential; and

- (3) For all other diagnostic source assemblies, the maximum-rated peak tube potential and the maximum-rated continuous tube current for the maximum-rated peak tube potential.

*Light field* means that area of the intersection of the light beam from the beam-limiting device and one of the set of planes parallel to and including the plane of the image receptor, whose perimeter is the locus of points at which the illuminance is one-fourth of the maximum in the intersection.

*Line-voltage regulation* means the difference between the no-load and the load line potentials expressed as a percent of the load line potential; that is,

$$\text{Percent line-voltage regulation} = \frac{100(V_n - V_i)}{V_i}$$

where:

$V_n$  = No-load line potential and  
 $V_i$  = Load line potential.

*Maximum line current* means the root mean square current in the supply line of an x-ray machine operating at its maximum rating.

*Mode of operation* means, for fluoroscopic systems, a distinct meth-

od of fluoroscopy or radiography provided by the manufacturer and selected with a set of several technique factors or other control settings uniquely associated with the mode. The set of distinct technique factors and control settings for the mode may be selected by the operation of a single control. Examples of distinct modes of operation include normal fluoroscopy (analog or digital), high-level control fluoroscopy, cineradiography (analog or digital), digital subtraction angiography, electronic radiography using the fluoroscopic image receptor, and photospot recording. In a specific mode of operation, certain system variables affecting air kerma, AKR, or image quality, such as image magnification, x-ray field size, pulse rate, pulse duration, number of pulses, source-image receptor distance (SID), or optical aperture, may be adjustable or may vary; their variation per se does not comprise a mode of operation different from the one that has been selected.

*Movable tabletop* means a tabletop which, when assembled for use, is capable of movement with respect to its supporting structure within the plane of the tabletop.

*Non-image-intensified fluoroscopy* means fluoroscopy using only a fluorescent screen.

*Peak tube potential* means the maximum value of the potential difference across the x-ray tube during an exposure.

*Primary protective barrier* means the material, excluding filters, placed in the useful beam to reduce the radiation exposure for protection purposes.

*Pulsed mode* means operation of the x-ray system such that the x-ray tube current is pulsed by the x-ray control to produce one or more exposure intervals of duration less than one-half second.

*Quick change x-ray tube* means an x-ray tube designed for use in its associated tube housing such that:

- (1) The tube cannot be inserted in its housing in a manner that would result in noncompliance of the system with the requirements of paragraphs (k) and (m) of this section;



(2) The focal spot position will not cause noncompliance with the provisions of this section or §1020.31 or 1020.32;

(3) The shielding within the tube housing cannot be displaced; and

(4) Any removal and subsequent replacement of a beam-limiting device during reloading of the tube in the tube housing will not result in noncompliance of the x-ray system with the applicable field limitation and alignment requirements of §§1020.31 and 1020.32.

*Radiation therapy simulation system* means a radiographic or fluoroscopic x-ray system intended for localizing the volume to be exposed during radiation therapy and confirming the position and size of the therapeutic irradiation field.

*Radiography* means a technique for generating and recording an x-ray pattern for the purpose of providing the user with an image(s) after termination of the exposure.

*Rated line voltage* means the range of potentials, in volts, of the supply line specified by the manufacturer at which the x-ray machine is designed to operate.

*Rated output current* means the maximum allowable load current of the x-ray high-voltage generator.

*Rated output voltage* means the allowable peak potential, in volts, at the output terminals of the x-ray high-voltage generator.

*Rating* means the operating limits specified by the manufacturer.

*Recording* means producing a retrievable form of an image resulting from x-ray photons.

*Scan* means the complete process of collecting x-ray transmission data for the production of a tomogram. Data may be collected simultaneously during a single scan for the production of one or more tomograms.

*Scan time* means the period of time between the beginning and end of x-ray transmission data accumulation for a single scan.

*Solid state x-ray imaging device* means an assembly, typically in a rectangular panel configuration, that intercepts x-ray photons and converts the photon energy into a modulated electronic signal representative of the x-ray intensity over the area of the imaging de-

vice. The electronic signal is then used to create an image for display and/or storage.

*Source* means the focal spot of the x-ray tube.

*Source-image receptor distance (SID)* means the distance from the source to the center of the input surface of the image receptor.

*Source-skin distance (SSD)* means the distance from the source to the center of the entrant x-ray field in the plane tangent to the patient skin surface.

*Spot-film device* means a device intended to transport and/or position a radiographic image receptor between the x-ray source and fluoroscopic image receptor. It includes a device intended to hold a cassette over the input end of the fluoroscopic image receptor for the purpose of producing a radiograph.

*Stationary tabletop* means a tabletop which, when assembled for use, is incapable of movement with respect to its supporting structure within the plane of the tabletop.

*Technique factors* means the following conditions of operation:

(1) For capacitor energy storage equipment, peak tube potential in kilovolts (kV) and quantity of charge in milliamperere-seconds (mAs);

(2) For field emission equipment rated for pulsed operation, peak tube potential in kV and number of x-ray pulses;

(3) For CT equipment designed for pulsed operation, peak tube potential in kV, scan time in seconds, and either tube current in milliamperes (mA), x-ray pulse width in seconds, and the number of x-ray pulses per scan, or the product of the tube current, x-ray pulse width, and the number of x-ray pulses in mAs;

(4) For CT equipment not designed for pulsed operation, peak tube potential in kV, and either tube current in mA and scan time in seconds, or the product of tube current and exposure time in mAs and the scan time when the scan time and exposure time are equivalent; and

(5) For all other equipment, peak tube potential in kV, and either tube current in mA and exposure time in seconds, or the product of tube current and exposure time in mAs.

*Tomogram* means the depiction of the x-ray attenuation properties of a section through a body.

*Tube* means an x-ray tube, unless otherwise specified.

*Tube housing assembly* means the tube housing with tube installed. It includes high-voltage and/or filament transformers and other appropriate elements when they are contained within the tube housing.

*Tube rating chart* means the set of curves which specify the rated limits of operation of the tube in terms of the technique factors.

*Useful beam* means the radiation which passes through the tube housing port and the aperture of the beam-limiting device when the exposure switch or timer is activated.

*Variable-aperture beam-limiting device* means a beam-limiting device which has the capacity for stepless adjustment of the x-ray field size at a given SID.

*Visible area* means the portion of the input surface of the image receptor over which incident x-ray photons are producing a visible image.

*X-ray control* means a device which controls input power to the x-ray high-voltage generator and/or the x-ray tube. It includes equipment such as timers, phototimers, automatic brightness stabilizers, and similar devices, which control the technique factors of an x-ray exposure.

*X-ray equipment* means an x-ray system, subsystem, or component thereof. Types of x-ray equipment are as follows:

(1) *Mobile x-ray equipment* means x-ray equipment mounted on a permanent base with wheels and/or casters for moving while completely assembled;

(2) *Portable x-ray equipment* means x-ray equipment designed to be hand-carried; and

(3) *Stationary x-ray equipment* means x-ray equipment which is installed in a fixed location.

*X-ray field* means that area of the intersection of the useful beam and any one of the set of planes parallel to and including the plane of the image receptor, whose perimeter is the locus of points at which the AKR is one-fourth of the maximum in the intersection.

*X-ray high-voltage generator* means a device which transforms electrical energy from the potential supplied by the x-ray control to the tube operating potential. The device may also include means for transforming alternating current to direct current, filament transformers for the x-ray tube(s), high-voltage switches, electrical protective devices, and other appropriate elements.

*X-ray subsystem* means any combination of two or more components of an x-ray system for which there are requirements specified in this section and §§ 1020.31 and 1020.32.

*X-ray system* means an assemblage of components for the controlled production of x-rays. It includes minimally an x-ray high-voltage generator, an x-ray control, a tube housing assembly, a beam-limiting device, and the necessary supporting structures. Additional components which function with the system are considered integral parts of the system.

*X-ray table* means a patient support device with its patient support structure (tabletop) interposed between the patient and the image receptor during radiography and/or fluoroscopy. This includes, but is not limited to, any stretcher equipped with a radiolucent panel and any table equipped with a cassette tray (or bucky), cassette tunnel, fluoroscopic image receptor, or spot-film device beneath the tabletop.

*X-ray tube* means any electron tube which is designed for the conversion of electrical energy into x-ray energy.

(c) *Manufacturers' responsibility.* Manufacturers of products subject to §§ 1020.30 through 1020.33 shall certify that each of their products meets all applicable requirements when installed into a diagnostic x-ray system according to instructions. This certification shall be made under the format specified in § 1010.2 of this chapter. Manufacturers may certify a combination of two or more components if they obtain prior authorization in writing from the Director, Center for Devices and Radiological Health. Manufacturers shall not be held responsible for noncompliance of their products if that noncompliance is due solely to the improper installation or assembly of that product by another person; however, manufacturers

are responsible for providing assembly instructions adequate to assure compliance of their components with the applicable provisions of §§1020.30 through 1020.33.

(d) *Assemblers' responsibility.* An assembler who installs one or more components certified as required by paragraph (c) of this section shall install certified components that are of the type required by §1020.31, §1020.32, or §1020.33 and shall assemble, install, adjust, and test the certified components according to the instructions of their respective manufacturers. Assemblers shall not be liable for noncompliance of a certified component if the assembly of that component was according to the component manufacturer's instruction.

(1) *Reports of assembly.* All assemblers who install certified components shall file a report of assembly, except as specified in paragraph (d)(2) of this section. The report will be construed as the assembler's certification and identification under §§1010.2 and 1010.3 of this chapter. The assembler shall affirm in the report that the manufacturer's instructions were followed in the assembly or that the certified components as assembled into the system meet all applicable requirements of §§1020.30 through 1020.33. All assembler reports must be on a form prescribed by the Director, CDRH. Completed reports must be submitted to the Director, the purchaser, and, where applicable, to the State agency responsible for radiation protection within 15 days following completion of the assembly.

(2) *Exceptions to reporting requirements.* Reports of assembly need not be submitted for any of the following:

(i) Reloaded or replacement tube housing assemblies that are reinstalled in or newly assembled into an existing x-ray system;

(ii) Certified accessory components that have been identified as such to CDRH in the report required under §1002.10 of this chapter;

(iii) Repaired components, whether or not removed from the system and reinstalled during the course of repair, provided the original installation into the system was reported; or

(iv)(A) Components installed temporarily in an x-ray system in place of

components removed temporarily for repair, provided the temporarily installed component is identified by a tag or label bearing the following information:

Temporarily Installed Component

This certified component has been assembled, installed, adjusted, and tested by me according to the instructions provided by the manufacturer.

Signature

Company Name

Street Address, P.O. Box

City, State, Zip Code

Date of Installation

(B) The replacement of the temporarily installed component by a component other than the component originally removed for repair shall be reported as specified in paragraph (d)(1) of this section.

(e) *Identification of x-ray components.*

In addition to the identification requirements specified in §1010.3 of this chapter, manufacturers of components subject to this section and §§1020.31, 1020.32, and 1020.33, except high-voltage generators contained within tube housings and beam-limiting devices that are integral parts of tube housings, shall permanently inscribe or affix thereon the model number and serial number of the product so that they are legible and accessible to view. The word "model" or "type" shall appear as part of the manufacturer's required identification of certified x-ray components. Where the certification of a system or subsystem, consisting of two or more components, has been authorized under paragraph (c) of this section, a single inscription, tag, or label bearing the model number and serial number may be used to identify the product.

(1) *Tube housing assemblies.* In a similar manner, manufacturers of tube housing assemblies shall also inscribe or affix thereon the name of the manufacturer, model number, and serial number of the x-ray tube which the tube housing assembly incorporates.

(2) *Replacement of tubes.* Except as specified in paragraph (e)(3) of this section, the replacement of an x-ray tube in a previously manufactured tube housing assembly certified under paragraph (c) of this section constitutes

manufacture of a new tube housing assembly, and the manufacturer is subject to the provisions of paragraph (e)(1) of this section. The manufacturer shall remove, cover, or deface any previously affixed inscriptions, tags, or labels that are no longer applicable.

(3) *Quick-change x-ray tubes.* The requirements of paragraph (e)(2) of this section shall not apply to tube housing assemblies designed and designated by their original manufacturer to contain quick change x-ray tubes. The manufacturer of quick-change x-ray tubes shall include with each replacement tube a label with the tube manufacturer's name, the model, and serial number of the x-ray tube. The manufacturer of the tube shall instruct the assembler who installs the new tube to attach the label to the tube housing assembly and to remove, cover, or deface the previously affixed inscriptions, tags, or labels that are described by the tube manufacturer as no longer applicable.

(f) [Reserved]

(g) *Information to be provided to assemblers.* Manufacturers of components listed in paragraph (a)(1) of this section shall provide to assemblers subject to paragraph (d) of this section and, upon request, to others at a cost not to exceed the cost of publication and distribution, instructions for assembly, installation, adjustment, and testing of such components adequate to assure that the products will comply with applicable provisions of this section and §§ 1020.31, 1020.32, and 1020.33, when assembled, installed, adjusted, and tested as directed. Such instructions shall include specifications of other components compatible with that to be installed when compliance of the system or subsystem depends on their compatibility. Such specifications may describe pertinent physical characteristics of the components and/or may list by manufacturer model number the components which are compatible. For x-ray controls and generators manufactured after May 3, 1994, manufacturers shall provide:

(1) A statement of the rated line voltage and the range of line-voltage regulation for operation at maximum line current;

(2) A statement of the maximum line current of the x-ray system based on the maximum input voltage and current characteristics of the tube housing assembly compatible with rated output voltage and rated output current characteristics of the x-ray control and associated high-voltage generator. If the rated input voltage and current characteristics of the tube housing assembly are not known by the manufacturer of the x-ray control and associated high-voltage generator, the manufacturer shall provide information necessary to allow the assembler to determine the maximum line current for the particular tube housing assembly(ies);

(3) A statement of the technique factors that constitute the maximum line current condition described in paragraph (g)(2) of this section.

(h) *Information to be provided to users.* Manufacturers of x-ray equipment shall provide to purchasers and, upon request, to others at a cost not to exceed the cost of publication and distribution, manuals or instruction sheets which shall include the following technical and safety information:

(1) *All x-ray equipment.* For x-ray equipment to which this section and §§ 1020.31, 1020.32, and 1020.33 are applicable, there shall be provided:

(i) Adequate instructions concerning any radiological safety procedures and precautions which may be necessary because of unique features of the equipment; and

(ii) A schedule of the maintenance necessary to keep the equipment in compliance with this section and §§ 1020.31, 1020.32, and 1020.33.

(2) *Tube housing assemblies.* For each tube housing assembly, there shall be provided:

(i) Statements of the leakage technique factors for all combinations of tube housing assemblies and beam-limiting devices for which the tube housing assembly manufacturer states compatibility, the minimum filtration permanently in the useful beam expressed as millimeters (mm) of aluminum equivalent, and the peak tube potential at which the aluminum equivalent was obtained;

(ii) Cooling curves for the anode and tube housing; and

(iii) Tube rating charts. If the tube is designed to operate from different types of x-ray high-voltage generators (such as single-phase self rectified, single-phase half-wave rectified, single-phase full-wave rectified, 3-phase 6-pulse, 3-phase 12-pulse, constant potential, capacitor energy storage) or under modes of operation such as alternate focal spot sizes or speeds of anode rotation which affect its rating, specific identification of the difference in ratings shall be noted.

(3) *X-ray controls and generators.* For the x-ray control and associated x-ray high-voltage generator, there shall be provided:

(i) A statement of the rated line voltage and the range of line-voltage regulation for operation at maximum line current;

(ii) A statement of the maximum line current of the x-ray system based on the maximum input voltage and output current characteristics of the tube housing assembly compatible with rated output voltage and rated current characteristics of the x-ray control and associated high-voltage generator. If the rated input voltage and current characteristics of the tube housing assembly are not known by the manufacturer of the x-ray control and associated high-voltage generator, the manufacturer shall provide necessary information to allow the purchaser to determine the maximum line current for his particular tube housing assembly(ies);

(iii) A statement of the technique factors that constitute the maximum line current condition described in paragraph (h)(3)(ii) of this section;

(iv) In the case of battery-powered generators, a specification of the minimum state of charge necessary for proper operation;

(v) Generator rating and duty cycle;

(vi) A statement of the maximum deviation from the preindication given by labeled technique factor control settings or indicators during any radiographic or CT exposure where the equipment is connected to a power supply as described in accordance with this paragraph. In the case of fixed technique factors, the maximum deviation

from the nominal fixed value of each factor shall be stated;

(vii) A statement of the maximum deviation from the continuous indication of x-ray tube potential and current during any fluoroscopic exposure when the equipment is connected to a power supply as described in accordance with this paragraph; and

(viii) A statement describing the measurement criteria for all technique factors used in paragraphs (h)(3)(iii), (h)(3)(vi), and (h)(3)(vii) of this section; for example, the beginning and endpoints of exposure time measured with respect to a certain percentage of the voltage waveform.

(4) *Beam-limiting device.* For each variable-aperture beam-limiting device, there shall be provided:

(i) Leakage technique factors for all combinations of tube housing assemblies and beam-limiting devices for which the beam-limiting device manufacturer states compatibility; and

(ii) A statement including the minimum aluminum equivalent of that part of the device through which the useful beam passes and including the x-ray tube potential at which the aluminum equivalent was obtained. When two or more filters are provided as part of the device, the statement shall include the aluminum equivalent of each filter.

(5) *Imaging system information.* For x-ray systems manufactured on or after June 10, 2006, that produce images using the fluoroscopic image receptor, the following information shall be provided in a separate, single section of the user's instruction manual or in a separate manual devoted to this information:

(i) For each mode of operation, a description of the mode and detailed instructions on how the mode is engaged and disengaged. The description of the mode shall identify those technique factors and system controls that are fixed or automatically adjusted by selection of the mode of operation, including the manner in which the automatic adjustment is controlled. This information shall include how the operator can recognize which mode of operation has been selected prior to initiation of x-ray production.

(ii) For each mode of operation, a descriptive example(s) of any specific clinical procedure(s) or imaging task(s) for which the mode is recommended or designed and how each mode should be used. Such recommendations do not preclude other clinical uses.

(6) *Displays of values of AKR and cumulative air kerma.* For fluoroscopic x-ray systems manufactured on or after June 10, 2006, the following shall be provided:

(i) A schedule of maintenance for any system instrumentation associated with the display of air kerma information necessary to maintain the displays of AKR and cumulative air kerma within the limits of allowed uncertainty specified by §1020.32(k)(6) and, if the capability for user calibration of the display is provided, adequate instructions for such calibration;

(ii) Identification of the distances along the beam axis:

(A) From the focal spot to the isocenter, and

(B) From the focal spot to the reference location to which displayed values of AKR and cumulative air kerma refer according to §1020.32(k)(4);

(iii) A rationale for specification of a reference irradiation location alternative to 15 cm from the isocenter toward the x-ray source along the beam axis when such alternative specification is made according to §1020.32(k)(4)(ii).

(i) [Reserved]

(j) *Warning label.* The control panel containing the main power switch shall bear the warning statement, legible and accessible to view:

“Warning: This x-ray unit may be dangerous to patient and operator unless safe exposure factors, operating instructions and maintenance schedules are observed.”

(k) *Leakage radiation from the diagnostic source assembly.* The leakage radiation from the diagnostic source assembly measured at a distance of 1 meter in any direction from the source shall not exceed 0.88 milligray (mGy) air kerma (vice 100 milliroentgen (mR) exposure) in 1 hour when the x-ray tube is operated at the leakage technique factors. If the maximum rated peak tube potential of the tube housing assembly is greater than the maximum rated peak tube potential for the diag-

nostic source assembly, positive means shall be provided to limit the maximum x-ray tube potential to that of the diagnostic source assembly. Compliance shall be determined by measurements averaged over an area of 100 square cm with no linear dimension greater than 20 cm.

(l) *Radiation from components other than the diagnostic source assembly.* The radiation emitted by a component other than the diagnostic source assembly shall not exceed an air kerma of 18 microGy (vice 2 mR exposure) in 1 hour at 5 cm from any accessible surface of the component when it is operated in an assembled x-ray system under any conditions for which it was designed. Compliance shall be determined by measurements averaged over an area of 100 square cm with no linear dimension greater than 20 cm.

(m) *Beam quality—(1) Half-value layer (HVL).* The HVL of the useful beam for a given x-ray tube potential shall not be less than the appropriate value shown in table 1 in paragraph (m)(1) of this section under the heading “Specified Dental Systems,” for any dental x-ray system designed for use with intraoral image receptors and manufactured after December 1, 1980; under the heading “I—Other X-Ray Systems,” for any dental x-ray system designed for use with intraoral image receptors and manufactured before December 1, 1980, and all other x-ray systems subject to this section and manufactured before June 10, 2006; and under the heading “II—Other X-Ray Systems,” for all x-ray systems, except dental x-ray systems designed for use with intraoral image receptors, subject to this section and manufactured on or after June 10, 2006. If it is necessary to determine such HVL at an x-ray tube potential which is not listed in table 1 in paragraph (m)(1) of this section, linear interpolation or extrapolation may be made. Positive means<sup>2</sup> shall be provided to ensure that at least the minimum filtration needed to achieve the above beam quality requirements is in

<sup>2</sup>In the case of a system, which is to be operated with more than one thickness of filtration, this requirement can be met by a filter interlocked with the kilovoltage selector which will prevent x-ray emissions if the minimum required filtration is not in place.

the useful beam during each exposure.  
Table 1 follows:

TABLE 1

X-Ray Tube Voltage (kilovolt peak)	Minimum HVL (mm of aluminum)			
	Measured Operating Potential	Specified Dental Systems <sup>1</sup>	I—Other X-Ray Systems <sup>2</sup>	II—Other X-Ray Systems <sup>3</sup>
Below 51	30	1.5	0.3	0.3
	40	1.5	0.4	0.4
	50	1.5	0.5	0.5
51 to 70	51	1.5	1.2	1.3
	60	1.5	1.3	1.5
	70	1.5	1.5	1.8
Above 70	71	2.1	2.1	2.5
	80	2.3	2.3	2.9
	90	2.5	2.5	3.2
	100	2.7	2.7	3.6
	110	3.0	3.0	3.9
	120	3.2	3.2	4.3
	130	3.5	3.5	4.7
	140	3.8	3.8	5.0
	150	4.1	4.1	5.4

<sup>1</sup> Dental x-ray systems designed for use with intraoral image receptors and manufactured after December 1, 1980.  
<sup>2</sup> Dental x-ray systems designed for use with intraoral image receptors and manufactured before or on December 1, 1980, and all other x-ray systems subject to this section and manufactured before June 10, 2006.  
<sup>3</sup> All x-ray systems, except dental x-ray systems designed for use with intraoral image receptors, subject to this section and manufactured on or after June 10, 2006.

(2) *Optional filtration.* Fluoroscopic systems manufactured on or after June 10, 2006, incorporating an x-ray tube(s) with a continuous output of 1 kilowatt or more and an anode heat storage capacity of 1 million heat units or more shall provide the option of adding x-ray filtration to the diagnostic source assembly in addition to the amount needed to meet the HVL provisions of §1020.30(m)(1). The selection of this additional x-ray filtration shall be either at the option of the user or automatic as part of the selected mode of operation. A means of indicating which combination of additional filtration is in the x-ray beam shall be provided.

(3) *Measuring compliance.* For capacitor energy storage equipment, compliance shall be determined with the maximum selectable quantity of charge per exposure.

(n) *Aluminum equivalent of material between patient and image receptor.* Except when used in a CT x-ray system, the aluminum equivalent of each of the items listed in table 2 in paragraph (n) of this section, which are used between the patient and image receptor, may not exceed the indicated limits. Compliance shall be determined by x-ray measurements made at a potential of 100 kilovolts peak and with an x-ray beam that has an HVL specified in table 1 in paragraph (m)(1) of this section for the potential. This requirement applies to front panel(s) of cassette holders and film changers provided by the manufacturer for patient support or for prevention of foreign object intrusions. It does not apply to screens and their associated mechanical support panels or grids. Table 2 follows:

TABLE 2

Item	Maximum Aluminum Equivalent (millimeters)
1. Front panel(s) of cassette holders (total of all)	1.2
2. Front panel(s) of film changer (total of all)	1.2
3. Cradle	2.3
4. Tabletop, stationary, without articulated joints	1.2
5. Tabletop, movable, without articulated joint(s) (including stationary subtop)	1.7
6. Tabletop, with radiolucent panel having one articulated joint	1.7
7. Tabletop, with radiolucent panel having two or more articulated joints	2.3

TABLE 2—Continued

Item	Maximum Aluminum Equivalent (millimeters)
8. Tabletop, cantilevered	2.3
9. Tabletop, radiation therapy simulator	5.0

(o) *Battery charge indicator.* On battery-powered generators, visual means shall be provided on the control panel to indicate whether the battery is in a state of charge adequate for proper operation.

(p) [Reserved]

(q) *Modification of certified diagnostic x-ray components and systems.* (1) Diagnostic x-ray components and systems certified in accordance with §1010.2 of this chapter shall not be modified such that the component or system fails to comply with any applicable provision of this chapter unless a variance in accordance with §1010.4 of this chapter or an exemption under section 534(a)(5) or 538(b) of the Federal Food, Drug, and Cosmetic Act has been granted.

(2) The owner of a diagnostic x-ray system who uses the system in a professional or commercial capacity may modify the system, provided the modification does not result in the failure of the system or component to comply with the applicable requirements of this section or of §1020.31, 1020.32, or 1020.33. The owner who causes such modification need not submit the reports required by subpart B of part 1002 of this chapter, provided the owner records the date and the details of the modification in the system records and maintains this information, and provided the modification of the x-ray system does not result in a failure to comply with §1020.31, 1020.32, or 1020.33.

[71 FR 34028, June 10, 2006, as amended at 72 FR 17401, Apr. 9, 2007; 83 FR 13864, Apr. 2, 2018]

**§ 1020.31 Radiographic equipment.**

The provisions of this section apply to equipment for radiography, except equipment for fluoroscopic imaging or for recording images from the fluoroscopic image receptor, or computed tomography x-ray systems manufactured on or after November 29, 1984.

(a) *Control and indication of technique factors—(1) Visual indication.* The technique factors to be used during an exposure shall be indicated before the exposure begins, except when automatic exposure controls are used, in which case the technique factors which are set prior to the exposure shall be indicated. On equipment having fixed technique factors, this requirement may be met by permanent markings. Indication of technique factors shall be visible from the operator's position except in the case of spot films made by the fluoroscopist.

(2) *Timers.* Means shall be provided to terminate the exposure at a preset time interval, a preset product of current and time, a preset number of pulses, or a preset radiation exposure to the image receptor.

(i) Except during serial radiography, the operator shall be able to terminate the exposure at any time during an exposure of greater than one-half second. Except during panoramic dental radiography, termination of exposure shall cause automatic resetting of the timer to its initial setting or to zero. It shall not be possible to make an exposure when the timer is set to a zero or off position if either position is provided.

(ii) During serial radiography, the operator shall be able to terminate the x-ray exposure(s) at any time, but means may be provided to permit completion of any single exposure of the series in process.

(3) *Automatic exposure controls.* When an automatic exposure control is provided:

(i) Indication shall be made on the control panel when this mode of operation is selected;

(ii) When the x-ray tube potential is equal to or greater than 51 kilovolts peak (kVp), the minimum exposure time for field emission equipment rated for pulsed operation shall be equal to or less than a time interval



equivalent to two pulses and the minimum exposure time for all other equipment shall be equal to or less than  $\frac{1}{60}$  second or a time interval required to deliver 5 milliamperere-seconds (mAs), whichever is greater;

(iii) Either the product of peak x-ray tube potential, current, and exposure time shall be limited to not more than 60 kilowatt-seconds (kW) per exposure or the product of x-ray tube current and exposure time shall be limited to not more than 600 mAs per exposure, except when the x-ray tube potential is less than 51 kVp, in which case the product of x-ray tube current and exposure time shall be limited to not more than 2,000 mAs per exposure; and

(iv) A visible signal shall indicate when an exposure has been terminated at the limits described in paragraph (a)(3)(iii) of this section, and manual resetting shall be required before further automatically timed exposures can be made.

(4) *Accuracy.* Deviation of technique factors from indicated values shall not exceed the limits given in the information provided in accordance with § 1020.30(h)(3).

(b) *Reproducibility.* The following requirements shall apply when the equipment is operated on an adequate power supply as specified by the manufacturer in accordance with the requirements of § 1020.30(h)(3):

(1) *Coefficient of variation.* For any specific combination of selected technique factors, the estimated coefficient of variation of the air kerma shall be no greater than 0.05.

(2) *Measuring compliance.* Determination of compliance shall be based on 10 consecutive measurements taken within a time period of 1 hour. Equipment manufactured after September 5, 1978, shall be subject to the additional requirement that all variable controls for technique factors shall be adjusted to alternate settings and reset to the test setting after each measurement. The percent line-voltage regulation shall be determined for each measurement. All values for percent line-voltage regulation shall be within  $\pm 1$  of the mean value for all measurements. For equipment having automatic exposure controls, compliance shall be determined with a sufficient thickness of attenu-

ating material in the useful beam such that the technique factors can be adjusted to provide individual exposures of a minimum of 12 pulses on field emission equipment rated for pulsed operation or no less than one-tenth second per exposure on all other equipment.

(c) *Linearity.* The following requirements apply when the equipment is operated on a power supply as specified by the manufacturer in accordance with the requirements of § 1020.30(h)(3) for any fixed x-ray tube potential within the range of 40 percent to 100 percent of the maximum rated.

(1) *Equipment having independent selection of x-ray tube current (mA).* The average ratios of air kerma to the indicated milliamperere-seconds product (mGy/mAs) obtained at any two consecutive tube current settings shall not differ by more than 0.10 times their sum. This is:  $|X_1 - X_2| \leq 0.10(X_1 + X_2)$ ; where  $X_1$  and  $X_2$  are the average mGy/mAs values obtained at each of two consecutive mAs selector settings or at two settings differing by no more than a factor of 2 where the mAs selector provides continuous selection.

(2) *Equipment having selection of x-ray tube current-exposure time product (mAs).* For equipment manufactured after May 3, 1994, the average ratios of air kerma to the indicated milliamperere-seconds product (mGy/mAs) obtained at any two consecutive mAs selector settings shall not differ by more than 0.10 times their sum. This is:  $|X_1 - X_2| \leq 0.10(X_1 + X_2)$ ; where  $X_1$  and  $X_2$  are the average mGy/mAs values obtained at each of two consecutive mAs selector settings or at two settings differing by no more than a factor of 2 where the mAs selector provides continuous selection.

(3) *Measuring compliance.* Determination of compliance will be based on 10 exposures, made within 1 hour, at each of the two settings. These two settings may include any two focal spot sizes except where one is equal to or less than 0.45 mm and the other is greater than 0.45 mm. For purposes of this requirement, focal spot size is the focal spot size specified by the x-ray tube manufacturer. The percent line-voltage regulation shall be determined for each measurement. All values for percent

line-voltage regulation at any one combination of technique factors shall be within  $\pm 1$  of the mean value for all measurements at these technique factors.

(d) *Field limitation and alignment for mobile, portable, and stationary general purpose x-ray systems.* Except when spot-film devices are in service, mobile, portable, and stationary general purpose radiographic x-ray systems shall meet the following requirements:

(1) *Variable x-ray field limitation.* A means for stepless adjustment of the size of the x-ray field shall be provided. Each dimension of the minimum field size at an SID of 100 centimeters (cm) shall be equal to or less than 5 cm.

(2) *Visual definition.* (i) Means for visually defining the perimeter of the x-ray field shall be provided. The total misalignment of the edges of the visually defined field with the respective edges of the x-ray field along either the length or width of the visually defined field shall not exceed 2 percent of the distance from the source to the center of the visually defined field when the surface upon which it appears is perpendicular to the axis of the x-ray beam.

(ii) When a light localizer is used to define the x-ray field, it shall provide an average illuminance of not less than 160 lux (15 footcandles) at 100 cm or at the maximum SID, whichever is less. The average illuminance shall be based on measurements made in the approximate center of each quadrant of the light field. Radiation therapy simulation systems are exempt from this requirement.

(iii) The edge of the light field at 100 cm or at the maximum SID, whichever is less, shall have a contrast ratio, corrected for ambient lighting, of not less than 4 in the case of beam-limiting devices designed for use on stationary equipment, and a contrast ratio of not less than 3 in the case of beam-limiting devices designed for use on mobile and portable equipment. The contrast ratio is defined as  $I_1/I_2$ , where  $I_1$  is the illuminance 3 mm from the edge of the light field toward the center of the field; and  $I_2$  is the illuminance 3 mm from the edge of the light field away from the center of the field. Compliance shall be

determined with a measuring aperture of 1 mm.

(e) *Field indication and alignment on stationary general purpose x-ray equipment.* Except when spot-film devices are in service, stationary general purpose x-ray systems shall meet the following requirements in addition to those prescribed in paragraph (d) of this section:

(1) Means shall be provided to indicate when the axis of the x-ray beam is perpendicular to the plane of the image receptor, to align the center of the x-ray field with respect to the center of the image receptor to within 2 percent of the SID, and to indicate the SID to within 2 percent;

(2) The beam-limiting device shall numerically indicate the field size in the plane of the image receptor to which it is adjusted;

(3) Indication of field size dimensions and SIDs shall be specified in centimeters and/or inches and shall be such that aperture adjustments result in x-ray field dimensions in the plane of the image receptor which correspond to those indicated by the beam-limiting device to within 2 percent of the SID when the beam axis is indicated to be perpendicular to the plane of the image receptor; and

(4) Compliance measurements will be made at discrete SIDs and image receptor dimensions in common clinical use (such as SIDs of 100, 150, and 200 cm and/or 36, 40, 48, and 72 inches and nominal image receptor dimensions of 13, 18, 24, 30, 35, 40, and 43 cm and/or 5, 7, 8, 9, 10, 11, 12, 14, and 17 inches) or at any other specific dimensions at which the beam-limiting device or its associated diagnostic x-ray system is uniquely designed to operate.

(f) *Field limitation on radiographic x-ray equipment other than general purpose radiographic systems—(1) Equipment for use with intraoral image receptors.* Radiographic equipment designed for use with an intraoral image receptor shall be provided with means to limit the x-ray beam such that:

(i) If the minimum source-to-skin distance (SSD) is 18 cm or more, the x-ray field at the minimum SSD shall be containable in a circle having a diameter of no more than 7 cm; and

(ii) If the minimum SSD is less than 18 cm, the x-ray field at the minimum SSD shall be containable in a circle having a diameter of no more than 6 cm.

(2) *X-ray systems designed for one image receptor size.* Radiographic equipment designed for only one image receptor size at a fixed SID shall be provided with means to limit the field at the plane of the image receptor to dimensions no greater than those of the image receptor, and to align the center of the x-ray field with the center of the image receptor to within 2 percent of the SID, or shall be provided with means to both size and align the x-ray field such that the x-ray field at the plane of the image receptor does not extend beyond any edge of the image receptor.

(3) *Systems designed for mammography*—(1) Radiographic systems designed only for mammography and general purpose radiography systems, when special attachments for mammography are in service, manufactured on or after November 1, 1977, and before September 30, 1999, shall be provided with means to limit the useful beam such that the x-ray field at the plane of the image receptor does not extend beyond any edge of the image receptor at any designated SID except the edge of the image receptor designed to be adjacent to the chest wall where the x-ray field may not extend beyond this edge by more than 2 percent of the SID. This requirement can be met with a system that performs as prescribed in paragraphs (f)(4)(i), (f)(4)(ii), and (f)(4)(iii) of this section. When the beam-limiting device and image receptor support device are designed to be used to immobilize the breast during a mammographic procedure and the SID may vary, the SID indication specified in paragraphs (f)(4)(ii) and (f)(4)(iii) of this section shall be the maximum SID for which the beam-limiting device or aperture is designed.

(ii) Mammographic beam-limiting devices manufactured on or after September 30, 1999, shall be provided with a means to limit the useful beam such that the x-ray field at the plane of the image receptor does not extend beyond any edge of the image receptor by more than 2 percent of the SID. This require-

ment can be met with a system that performs as prescribed in paragraphs (f)(4)(i), (f)(4)(ii), and (f)(4)(iii) of this section. For systems that allow changes in the SID, the SID indication specified in paragraphs (f)(4)(ii) and (f)(4)(iii) of this section shall be the maximum SID for which the beam-limiting device or aperture is designed.

(iii) Each image receptor support device manufactured on or after November 1, 1977, intended for installation on a system designed for mammography shall have clear and permanent markings to indicate the maximum image receptor size for which it is designed.

(4) *Other x-ray systems.* Radiographic systems not specifically covered in paragraphs (d), (e), (f)(2), (f)(3), and (h) of this section and systems covered in paragraph (f)(1) of this section, which are also designed for use with extraoral image receptors and when used with an extraoral image receptor, shall be provided with means to limit the x-ray field in the plane of the image receptor so that such field does not exceed each dimension of the image receptor by more than 2 percent of the SID, when the axis of the x-ray beam is perpendicular to the plane of the image receptor. In addition, means shall be provided to align the center of the x-ray field with the center of the image receptor to within 2 percent of the SID, or means shall be provided to both size and align the x-ray field such that the x-ray field at the plane of the image receptor does not extend beyond any edge of the image receptor. These requirements may be met with:

(i) A system which performs in accordance with paragraphs (d) and (e) of this section; or when alignment means are also provided, may be met with either;

(ii) An assortment of removable, fixed-aperture, beam-limiting devices sufficient to meet the requirement for each combination of image receptor size and SID for which the unit is designed. Each such device shall have clear and permanent markings to indicate the image receptor size and SID for which it is designed; or

(iii) A beam-limiting device having multiple fixed apertures sufficient to meet the requirement for each combination of image receptor size and SID

for which the unit is designed. Permanent, clearly legible markings shall indicate the image receptor size and SID for which each aperture is designed and shall indicate which aperture is in position for use.

(g) *Positive beam limitation (PBL)*. The requirements of this paragraph shall apply to radiographic systems which contain PBL.

(1) *Field size*. When a PBL system is provided, it shall prevent x-ray production when:

(i) Either the length or width of the x-ray field in the plane of the image receptor differs from the corresponding image receptor dimension by more than 3 percent of the SID; or

(ii) The sum of the length and width differences as stated in paragraph (g)(1)(i) of this section without regard to sign exceeds 4 percent of the SID.

(iii) The beam limiting device is at an SID for which PBL is not designed for sizing.

(2) *Conditions for PBL*. When provided, the PBL system shall function as described in paragraph (g)(1) of this section whenever all the following conditions are met:

(i) The image receptor is inserted into a permanently mounted cassette holder;

(ii) The image receptor length and width are less than 50 cm;

(iii) The x-ray beam axis is within  $\pm 3$  degrees of vertical and the SID is 90 cm to 130 cm inclusive; or the x-ray beam axis is within  $\pm 3$  degrees of horizontal and the SID is 90 cm to 205 cm inclusive;

(iv) The x-ray beam axis is perpendicular to the plane of the image receptor to within  $\pm 3$  degrees; and

(v) Neither tomographic nor stereoscopic radiography is being performed.

(3) *Measuring compliance*. Compliance with the requirements of paragraph (g)(1) of this section shall be determined when the equipment indicates that the beam axis is perpendicular to the plane of the image receptor and the provisions of paragraph (g)(2) of this section are met. Compliance shall be determined no sooner than 5 seconds after insertion of the image receptor.

(4) *Operator initiated undersizing*. The PBL system shall be capable of operation such that, at the discretion of

the operator, the size of the field may be made smaller than the size of the image receptor through stepless adjustment of the field size. Each dimension of the minimum field size at an SID of 100 cm shall be equal to or less than 5 cm. Return to PBL function as described in paragraph (g)(1) of this section shall occur automatically upon any change of image receptor size or SID.

(5) *Override of PBL*. A capability may be provided for overriding PBL in case of system failure and for servicing the system. This override may be for all SIDs and image receptor sizes. A key shall be required for any override capability that is accessible to the operator. It shall not be possible to remove the key while PBL is overridden. Each such key switch or key shall be clearly and durably labeled as follows:

For X-ray Field Limitation System Failure  
The override capability is considered accessible to the operator if it is referenced in the operator's manual or in other material intended for the operator or if its location is such that the operator would consider it part of the operational controls.

(h) *Field limitation and alignment for spot-film devices*. The following requirements shall apply to spot-film devices, except when the spot-film device is provided for use with a radiation therapy simulation system:

(1) Means shall be provided between the source and the patient for adjustment of the x-ray field size in the plane of the image receptor to the size of that portion of the image receptor which has been selected on the spot-film selector. Such adjustment shall be accomplished automatically when the x-ray field size in the plane of the image receptor is greater than the selected portion of the image receptor. If the x-ray field size is less than the size of the selected portion of the image receptor, the field size shall not open automatically to the size of the selected portion of the image receptor unless the operator has selected that mode of operation.

(2) Neither the length nor the width of the x-ray field in the plane of the image receptor shall differ from the corresponding dimensions of the selected portion of the image receptor by more than 3 percent of the SID when

adjusted for full coverage of the selected portion of the image receptor. The sum, without regard to sign, of the length and width differences shall not exceed 4 percent of the SID. On spot-film devices manufactured after February 25, 1978, if the angle between the plane of the image receptor and beam axis is variable, means shall be provided to indicate when the axis of the x-ray beam is perpendicular to the plane of the image receptor, and compliance shall be determined with the beam axis indicated to be perpendicular to the plane of the image receptor.

(3) The center of the x-ray field in the plane of the image receptor shall be aligned with the center of the selected portion of the image receptor to within 2 percent of the SID.

(4) Means shall be provided to reduce the x-ray field size in the plane of the image receptor to a size smaller than the selected portion of the image receptor such that:

(i) For spot-film devices used on fixed-SID fluoroscopic systems which are not required to, and do not provide stepless adjustment of the x-ray field, the minimum field size, at the greatest SID, does not exceed 125 square cm; or

(ii) For spot-film devices used on fluoroscopic systems that have a variable SID and/or stepless adjustment of the field size, the minimum field size, at the greatest SID, shall be containable in a square of 5 cm by 5 cm.

(5) A capability may be provided for overriding the automatic x-ray field size adjustment in case of system failure. If it is so provided, a signal visible at the fluoroscopist's position shall indicate whenever the automatic x-ray field size adjustment override is engaged. Each such system failure override switch shall be clearly labeled as follows:

For X-ray Field Limitation System Failure

(i) *Source-skin distance*—(1) X-ray systems designed for use with an intraoral image receptor shall be provided with means to limit the source-skin distance to not less than:

(i) Eighteen cm if operable above 50 kVp; or

(ii) Ten cm if not operable above 50 kVp.

(2) Mobile and portable x-ray systems other than dental shall be provided with means to limit the source-skin distance to not less than 30 cm.

(j) *Beam-on indicators*. The x-ray control shall provide visual indication whenever x-rays are produced. In addition, a signal audible to the operator shall indicate that the exposure has terminated.

(k) *Multiple tubes*. Where two or more radiographic tubes are controlled by one exposure switch, the tube or tubes which have been selected shall be clearly indicated before initiation of the exposure. This indication shall be both on the x-ray control and at or near the tube housing assembly which has been selected.

(l) *Radiation from capacitor energy storage equipment*. Radiation emitted from the x-ray tube shall not exceed:

(1) An air kerma of 0.26 microGy (vice 0.03 mR exposure) in 1 minute at 5 cm from any accessible surface of the diagnostic source assembly, with the beam-limiting device fully open, the system fully charged, and the exposure switch, timer, or any discharge mechanism not activated. Compliance shall be determined by measurements averaged over an area of 100 square cm, with no linear dimension greater than 20 cm; and

(2) An air kerma of 0.88 mGy (vice 100 mR exposure) in 1 hour at 100 cm from the x-ray source, with the beam-limiting device fully open, when the system is discharged through the x-ray tube either manually or automatically by use of a discharge switch or deactivation of the input power. Compliance shall be determined by measurements of the maximum air kerma per discharge multiplied by the total number of discharges in 1 hour (duty cycle). The measurements shall be averaged over an area of 100 square cm with no linear dimension greater than 20 cm.

(m) *Primary protective barrier for mammography x-ray systems*—(1) For x-ray systems manufactured after September 5, 1978, and before September 30, 1999, which are designed only for mammography, the transmission of the primary beam through any image receptor support provided with the system shall be limited such that the air kerma 5 cm from any accessible surface beyond the plane of the image receptor supporting

device does not exceed 0.88 microGy (vice 0.1 mR exposure) for each activation of the tube.

(2) For mammographic x-ray systems manufactured on or after September 30, 1999:

(i) At any SID where exposures can be made, the image receptor support device shall provide a primary protective barrier that intercepts the cross section of the useful beam along every direction except at the chest wall edge.

(ii) The x-ray system shall not permit exposure unless the appropriate barrier is in place to intercept the useful beam as required in paragraph (m)(2)(i) of this section.

(iii) The transmission of the useful beam through the primary protective barrier shall be limited such that the air kerma 5 cm from any accessible surface beyond the plane of the primary protective barrier does not exceed 0.88 microGy (vice 0.1 mR exposure) for each activation of the tube.

(3) Compliance with the requirements of paragraphs (m)(1) and (m)(2)(iii) of this section for transmission shall be determined with the x-ray system operated at the minimum SID for which it is designed, at the maximum rated peak tube potential, at the maximum rated product of x-ray tube current and exposure time (mAs) for the maximum rated peak tube potential, and by measurements averaged over an area of 100 square cm with no linear dimension greater than 20 cm. The sensitive volume of the radiation measuring instrument shall not be positioned beyond the edge of the primary protective barrier along the chest wall side.

[70 FR 34036, June 10, 2005]

#### § 1020.32 Fluoroscopic equipment.

The provisions of this section apply to equipment for fluoroscopic imaging or for recording images from the fluoroscopic image receptor, except computed tomography x-ray systems manufactured on or after November 29, 1984.

(a) *Primary protective barrier*—(1) *Limitation of useful beam.* The fluoroscopic imaging assembly shall be provided with a primary protective barrier which intercepts the entire cross section of the useful beam at any SID. The x-ray tube used for fluoroscopy shall

not produce x-rays unless the barrier is in position to intercept the entire useful beam. The AKR due to transmission through the barrier with the attenuation block in the useful beam combined with radiation from the fluoroscopic image receptor shall not exceed  $3.34 \times 10^{-3}$  percent of the entrance AKR, at a distance of 10 cm from any accessible surface of the fluoroscopic imaging assembly beyond the plane of the image receptor. Radiation therapy simulation systems shall be exempt from this requirement provided the systems are intended only for remote control operation and the manufacturer sets forth instructions for assemblers with respect to control location as part of the information required in §1020.30(g). Additionally, the manufacturer shall provide to users, under §1020.30(h)(1)(i), precautions concerning the importance of remote control operation.

(2) *Measuring compliance.* The AKR shall be measured in accordance with paragraph (d) of this section. The AKR due to transmission through the primary barrier combined with radiation from the fluoroscopic image receptor shall be determined by measurements averaged over an area of 100 square cm with no linear dimension greater than 20 cm. If the source is below the tabletop, the measurement shall be made with the input surface of the fluoroscopic imaging assembly positioned 30 cm above the tabletop. If the source is above the tabletop and the SID is variable, the measurement shall be made with the end of the beam-limiting device or spacer as close to the tabletop as it can be placed, provided that it shall not be closer than 30 cm. Movable grids and compression devices shall be removed from the useful beam during the measurement. For all measurements, the attenuation block shall be positioned in the useful beam 10 cm from the point of measurement of entrance AKR and between this point and the input surface of the fluoroscopic imaging assembly.

(b) *Field limitation*—(1) *Angulation.* For fluoroscopic equipment manufactured after February 25, 1978, when the angle between the image receptor and the beam axis of the x-ray beam is

variable, means shall be provided to indicate when the axis of the x-ray beam is perpendicular to the plane of the image receptor. Compliance with paragraphs (b)(4) and (b)(5) of this section shall be determined with the beam axis indicated to be perpendicular to the plane of the image receptor.

(2) *Further means for limitation.* Means shall be provided to permit further limitation of the x-ray field to sizes smaller than the limits of paragraphs (b)(4) and (b)(5). Beam-limiting devices manufactured after May 22, 1979, and incorporated in equipment with a variable SID and/or the capability of a visible area of greater than 300 square cm, shall be provided with means for stepless adjustment of the x-ray field. Equipment with a fixed SID and the capability of a visible area of no greater than 300 square cm shall be provided with either stepless adjustment of the x-ray field or with a means to further limit the x-ray field size at the plane of the image receptor to 125 square cm or less. Stepless adjustment shall, at the greatest SID, provide continuous field sizes from the maximum obtainable to a field size containable in a square of 5 cm by 5 cm. This paragraph does not apply to non-image-intensified fluoroscopy.

(3) *Non-image-intensified fluoroscopy.* The x-ray field produced by non-image-intensified fluoroscopic equipment shall not extend beyond the entire visible area of the image receptor. Means shall be provided for stepless adjustment of field size. The minimum field size, at the greatest SID, shall be containable in a square of 5 cm by 5 cm.

(4) *Fluoroscopy and radiography using the fluoroscopic imaging assembly with inherently circular image receptors.* (i) For fluoroscopic equipment manufactured before June 10, 2006, other than radiation therapy simulation systems, the following applies:

(A) Neither the length nor the width of the x-ray field in the plane of the image receptor shall exceed that of the visible area of the image receptor by more than 3 percent of the SID. The sum of the excess length and the excess width shall be no greater than 4 percent of the SID.

(B) For rectangular x-ray fields used with circular image receptors, the

error in alignment shall be determined along the length and width dimensions of the x-ray field which pass through the center of the visible area of the image receptor.

(ii) For fluoroscopic equipment manufactured on or after June 10, 2006, other than radiation therapy simulation systems, the maximum area of the x-ray field in the plane of the image receptor shall conform with one of the following requirements:

(A) When every linear dimension of the visible area of the image receptor measured through the center of the visible area is less than or equal to 34 cm in any direction, at least 80 percent of the area of the x-ray field overlaps the visible area of the image.

(B) When any linear dimension of the visible area of the image receptor measured through the center of the visible area is greater than 34 cm in any direction, the x-ray field measured along the direction of greatest misalignment with the visible area of the image receptor does not extend beyond the edge of the visible area of the image receptor by more than 2 cm.

(5) *Fluoroscopy and radiography using the fluoroscopic imaging assembly with inherently rectangular image receptors.* For x-ray systems manufactured on or after June 10, 2006, the following applies:

(i) Neither the length nor the width of the x-ray field in the plane of the image receptor shall exceed that of the visible area of the image receptor by more than 3 percent of the SID. The sum of the excess length and the excess width shall be no greater than 4 percent of the SID.

(ii) The error in alignment shall be determined along the length and width dimensions of the x-ray field which pass through the center of the visible area of the image receptor.

(6) *Override capability.* If the fluoroscopic x-ray field size is adjusted automatically as the SID or image receptor size is changed, a capability may be provided for overriding the automatic adjustment in case of system failure. If it is so provided, a signal visible at the fluoroscopist's position shall indicate whenever the automatic field adjustment is overridden. Each

§ 1020.32

21 CFR Ch. I (4-1-20 Edition)

such system failure override switch shall be clearly labeled as follows:

For X-ray Field Limitation System Failure

(c) *Activation of tube.* X-ray production in the fluoroscopic mode shall be controlled by a device which requires continuous pressure by the operator for the entire time of any exposure. When recording serial radiographic images from the fluoroscopic image receptor, the operator shall be able to terminate the x-ray exposure(s) at any time, but means may be provided to permit completion of any single exposure of the series in process.

(d) *Air kerma rates.* For fluoroscopic equipment, the following requirements apply:

(1) *Fluoroscopic equipment manufactured before May 19, 1995*—(i) Equipment provided with automatic exposure rate control (AERC) shall not be operable at any combination of tube potential and current that will result in an AKR in excess of 88 mGy per minute (vice 10 R/min exposure rate) at the measurement point specified in §1020.32(d)(3), except as specified in §1020.32(d)(1)(v).

(ii) Equipment provided without AERC shall not be operable at any combination of tube potential and current that will result in an AKR in excess of 44 mGy per minute (vice 5 R/min exposure rate) at the measurement point specified in §1020.32(d)(3), except as specified in §1020.32(d)(1)(v).

(iii) Equipment provided with both an AERC mode and a manual mode shall not be operable at any combination of tube potential and current that will result in an AKR in excess of 88 mGy per minute (vice 10 R/min exposure rate) in either mode at the measurement point specified in §1020.32(d)(3), except as specified in §1020.32(d)(1)(v).

(iv) Equipment may be modified in accordance with §1020.30(q) to comply with §1020.32(d)(2). When the equipment is modified, it shall bear a label indicating the date of the modification and the statement:

Modified to comply with 21 CFR 1020.32(h)(2).

(v) Exceptions:

(A) During recording of fluoroscopic images, or

(B) When a mode of operation has an optional high-level control, in which case that mode shall not be operable at any combination of tube potential and current that will result in an AKR in excess of the rates specified in §1020.32(d)(1)(i), (d)(1)(ii), or (d)(1)(iii) at the measurement point specified in §1020.32(d)(3), unless the high-level control is activated. Special means of activation of high-level controls shall be required. The high-level control shall be operable only when continuous manual activation is provided by the operator. A continuous signal audible to the fluoroscopist shall indicate that the high-level control is being employed.

(2) *Fluoroscopic equipment manufactured on or after May 19, 1995*—(i) Shall be equipped with AERC if operable at any combination of tube potential and current that results in an AKR greater than 44 mGy per minute (vice 5 R/min exposure rate) at the measurement point specified in §1020.32(d)(3). Provision for manual selection of technique factors may be provided.

(ii) Shall not be operable at any combination of tube potential and current that will result in an AKR in excess of 88 mGy per minute (vice 10 R/min exposure rate) at the measurement point specified in §1020.32(d)(3), except as specified in §1020.32(d)(2)(iii):

(iii) Exceptions:

(A) For equipment manufactured prior to June 10, 2006, during the recording of images from a fluoroscopic image receptor using photographic film or a video camera when the x-ray source is operated in a pulsed mode.

(B) For equipment manufactured on or after June 10, 2006, during the recording of images from the fluoroscopic image receptor for the purpose of providing the user with a recorded image(s) after termination of the exposure. Such recording does not include images resulting from a last-image-hold feature that are not recorded.

(C) When a mode of operation has an optional high-level control and the control is activated, in which case the equipment shall not be operable at any combination of tube potential and current that will result in an AKR in excess of 176 mGy per minute (vice 20 R/



min exposure rate) at the measurement point specified in §1020.32(d)(3). Special means of activation of high-level controls shall be required. The high-level control shall be operable only when continuous manual activation is provided by the operator. A continuous signal audible to the fluoroscopist shall indicate that the high-level control is being employed.

(3) *Measuring compliance.* Compliance with paragraph (d) of this section shall be determined as follows:

(i) If the source is below the x-ray table, the AKR shall be measured at 1 cm above the tabletop or cradle.

(ii) If the source is above the x-ray table, the AKR shall be measured at 30 cm above the tabletop with the end of the beam-limiting device or spacer positioned as closely as possible to the point of measurement.

(iii) In a C-arm type of fluoroscope, the AKR shall be measured at 30 cm from the input surface of the fluoroscopic imaging assembly, with the source positioned at any available SID, provided that the end of the beam-limiting device or spacer is no closer than 30 cm from the input surface of the fluoroscopic imaging assembly.

(iv) In a C-arm type of fluoroscope having an SID less than 45 cm, the AKR shall be measured at the minimum SSD.

(v) In a lateral type of fluoroscope, the air kerma rate shall be measured at a point 15 cm from the centerline of the x-ray table and in the direction of the x-ray source with the end of the beam-limiting device or spacer positioned as closely as possible to the point of measurement. If the tabletop is movable, it shall be positioned as closely as possible to the lateral x-ray source, with the end of the beam-limiting device or spacer no closer than 15 cm to the centerline of the x-ray table.

(4) *Exemptions.* Fluoroscopic radiation therapy simulation systems are exempt from the requirements set forth in paragraph (d) of this section.

(e) [Reserved]

(f) *Indication of potential and current.* During fluoroscopy and cinefluorography, x-ray tube potential and current shall be continuously indicated. Deviation of x-ray tube potential and current from the indicated val-

ues shall not exceed the maximum deviation as stated by the manufacturer in accordance with §1020.30(h)(3).

(g) *Source-skin distance.* (1) Means shall be provided to limit the source-skin distance to not less than 38 cm on stationary fluoroscopes and to not less than 30 cm on mobile and portable fluoroscopes. In addition, for fluoroscopes intended for specific surgical application that would be prohibited at the source-skin distances specified in this paragraph, provisions may be made for operation at shorter source-skin distances but in no case less than 20 cm. When provided, the manufacturer must set forth precautions with respect to the optional means of spacing, in addition to other information as required in §1020.30(h).

(2) For stationary, mobile, or portable C-arm fluoroscopic systems manufactured on or after June 10, 2006, having a maximum source-image receptor distance of less than 45 cm, means shall be provided to limit the source-skin distance to not less than 19 cm. Such systems shall be labeled for extremity use only. In addition, for those systems intended for specific surgical application that would be prohibited at the source-skin distances specified in this paragraph, provisions may be made for operation at shorter source-skin distances but in no case less than 10 cm. When provided, the manufacturer must set forth precautions with respect to the optional means of spacing, in addition to other information as required in §1020.30(h).

(h) *Fluoroscopic irradiation time, display, and signal.* (1)(i) Fluoroscopic equipment manufactured before June 10, 2006, shall be provided with means to preset the cumulative irradiation time of the fluoroscopic tube. The maximum cumulative time of the timing device shall not exceed 5 minutes without resetting. A signal audible to the fluoroscopist shall indicate the completion of any preset cumulative irradiation-time. Such signal shall continue to sound while x-rays are produced until the timing device is reset. Fluoroscopic equipment may be modified in accordance with §1020.30(q) to comply with the requirements of §1020.32(h)(2). When the equipment is

§ 1020.32

21 CFR Ch. I (4-1-20 Edition)

modified, it shall bear a label indicating the statement:

Modified to comply with 21 CFR 1020.32(h)(2).

(ii) As an alternative to the requirements of this paragraph, radiation therapy simulation systems may be provided with a means to indicate the total cumulative exposure time during which x-rays were produced, and which is capable of being reset between x-ray examinations.

(2) For x-ray controls manufactured on or after June 10, 2006, there shall be provided for each fluoroscopic tube:

(i) A display of the fluoroscopic irradiation time at the fluoroscopist's working position. This display shall function independently of the audible signal described in §1020.32(h)(2)(ii). The following requirements apply:

(A) When the x-ray tube is activated, the fluoroscopic irradiation time in minutes and tenths of minutes shall be continuously displayed and updated at least once every 6 seconds.

(B) The fluoroscopic irradiation time shall also be displayed within 6 seconds of termination of an exposure and remain displayed until reset.

(C) Means shall be provided to reset the display to zero prior to the beginning of a new examination or procedure.

(ii) A signal audible to the fluoroscopist shall sound for each passage of 5 minutes of fluoroscopic irradiation time during an examination or procedure. The signal shall sound until manually reset or, if automatically reset, for at least 2 second.

(i) *Mobile and portable fluoroscopes.* In addition to the other requirements of this section, mobile and portable fluoroscopes shall provide an image receptor incorporating more than a simple fluorescent screen.

(j) *Display of last-image-hold (LIH).* Fluoroscopic equipment manufactured on or after June 10, 2006, shall be equipped with means to display LIH image following termination of the fluoroscopic exposure.

(1) For an LIH image obtained by retaining pretermination fluoroscopic images, if the number of images and method of combining images are selectable by the user, the selection shall

be indicated prior to initiation of the fluoroscopic exposure.

(2) For an LIH image obtained by initiating a separate radiographic-like exposure at the termination of fluoroscopic imaging, the technique factors for the LIH image shall be selectable prior to the fluoroscopic exposure, and the combination selected shall be indicated prior to initiation of the fluoroscopic exposure.

(3) Means shall be provided to clearly indicate to the user whether a displayed image is the LIH radiograph or fluoroscopy. Display of the LIH radiograph shall be replaced by the fluoroscopic image concurrently with re-initiation of fluoroscopic exposure, unless separate displays are provided for the LIH radiograph and fluoroscopic images.

(4) The predetermined or selectable options for producing the LIH radiograph shall be described in the information required by §1020.30(h). The information shall include a description of any technique factors applicable for the selected option and the impact of the selectable options on image characteristics and the magnitude of radiation emissions.

(k) *Displays of values of AKR and cumulative air kerma.* Fluoroscopic equipment manufactured on or after June 10, 2006, shall display at the fluoroscopist's working position the AKR and cumulative air kerma. The following requirements apply for each x-ray tube used during an examination or procedure:

(1) When the x-ray tube is activated and the number of images produced per unit time is greater than six images per second, the AKR in mGy/min shall be continuously displayed and updated at least once every second.

(2) The cumulative air kerma in units of mGy shall be displayed either within 5 seconds of termination of an exposure or displayed continuously and updated at least once every 5 seconds.

(3) The display of the AKR shall be clearly distinguishable from the display of the cumulative air kerma.

(4) The AKR and cumulative air kerma shall represent the value for conditions of free-in-air irradiation at one of the following reference locations

specified according to the type of fluoroscope. The reference location shall be identified and described specifically in the information provided to users according to §1020.30(h)(6)(iii).

(i) For fluoroscopes with x-ray source below the x-ray table, x-ray source above the table, or of lateral type, the reference locations shall be the respective locations specified in §1020.32(d)(3)(i), (d)(3)(ii), or (d)(3)(v) for measuring compliance with air-kerma rate limits.

(ii) For C-arm fluoroscopes, the reference location shall be 15 cm from the isocenter toward the x-ray source along the beam axis. Alternatively, the reference location shall be at a point specified by the manufacturer to represent the location of the intersection of the x-ray beam with the patient's skin.

(5) Means shall be provided to reset to zero the display of cumulative air kerma prior to the commencement of a new examination or procedure.

(6) The displayed AKR and cumulative air kerma shall not deviate from the actual values by more than ±35 percent over the range of 6 mGy/min and 100 mGy to the maximum indication of AKR and cumulative air kerma, respectively. Compliance shall be determined with an irradiation time greater than 3 seconds.

[70 FR 34039, June 10, 2005, as amended at 80 FR 19532, Apr. 13, 2015]

### § 1020.33 Computed tomography (CT) equipment.

(a) *Applicability.* (1) The provisions of this section, except for paragraphs (b), (c)(1), and (c)(2) are applicable as specified herein to CT x-ray systems manufactured or remanufactured on or after September 3, 1985.

(2) The provisions of paragraphs (b), (c)(1), and (c)(2) are applicable to CT x-ray systems manufactured or remanufactured on or after November 29, 1984.

(b) *Definitions.* As used in this section, the following definitions apply:

(1) *Computed tomography dose index (CTDI)* means the integral of the dose profile along a line perpendicular to the tomographic plane divided by the product of the nominal tomographic section thickness and the number of

tomograms produced in a single scan; that is:

$$CTDI = 1/nT \int_{-7T}^{+7T} D(z)dz$$

where:

$z$  = position along a line perpendicular to the tomographic plane.

$D(z)$  = Dose at position  $z$ .

$T$  = Nominal tomographic section thickness.

$n$  = Number of tomograms produced in a single scan.

This definition assumes that the dose profile is centered around  $z = 0$  and that, for a multiple tomogram system, the scan increment between adjacent scans is  $nT$ .

(2) *Contrast scale* means the change in linear attenuation coefficient per CT number relative to water; that is:

$$\text{Contrast scale} = \frac{\mu_x - \mu_w}{(CT)_x - (CT)_w}$$

where:

$\mu_w$  = Linear attenuation coefficient of water.

$\mu_x$  = Linear attenuation coefficient of material of interest.

$(CT)_w$  = CT number of water.

$(CT)_x$  = CT number of material of interest.

(3) *CT conditions of operation* means all selectable parameters governing the operation of a CT x-ray system including nominal tomographic section thickness, filtration, and the technique factors as defined in §1020.30(b)(36).

(4) *CT number* means the number used to represent the x-ray attenuation associated with each elemental area of the CT image.

(5) [Reserved]

(6) *CT dosimetry phantom* means the phantom used for determination of the dose delivered by a CT x-ray system. The phantom shall be a right circular cylinder of polymethyl-methacrylate of density  $1.19 \pm 0.01$  grams per cubic centimeter. The phantom shall be at least 14 centimeters in length and shall have diameters of 32.0 centimeters for testing any CT system designed to image any section of the body (whole body scanners) and 16.0 centimeters for any system designed to image the head (head scanners) or for any whole body scanner operated in the head scanning mode. The phantom shall provide

means for the placement of a dosimeter(s) along its axis of rotation and along a line parallel to the axis of rotation 1.0 centimeter from the outer surface and within the phantom. Means for the placement of a dosimeter(s) or alignment device at other locations may be provided for convenience. The means used for placement of a dosimeter(s) (i.e., hole size) and the type of dosimeter(s) used is at the discretion of the manufacturer. Any effect on the doses measured due to the removal of phantom material to accommodate dosimeters shall be accounted for through appropriate corrections to the reported data or included in the statement of maximum deviation for the values obtained using the phantom.

(7) *Dose profile* means the dose as a function of position along a line.

(8) *Modulation transfer function* means the modulus of the Fourier transform of the impulse response of the system.

(9) *Multiple tomogram system* means a CT x-ray system which obtains x-ray transmission data simultaneously during a single scan to produce more than one tomogram.

(10) *Noise* means the standard deviation of the fluctuations in CT number expressed as a percent of the attenuation coefficient of water. Its estimate ( $S_n$ ) is calculated using the following expression:

$$S_n = \frac{100 \times CS \times s}{\mu_w}$$

where:

CS = Contrast scale.

$\mu_w$  = Linear attenuation coefficient of water.

s = Estimated standard deviation of the CT numbers of picture elements in a specified area of the CT image.

(11) *Nominal tomographic section thickness* means the full-width at half-maximum of the sensitivity profile taken at the center of the cross-sectional volume over which x-ray transmission data are collected.

(12) *Picture element* means an elemental area of a tomogram.

(13) *Remanufacturing* means modifying a CT system in such a way that the resulting dose and imaging performance become substantially equivalent to any CT x-ray system manufactured by the original manufacturer on

or after November 29, 1984. Any reference in this section to “manufacture”, “manufacturer”, or “manufacturing” includes remanufacture, re-manufacturer, or remanufacturing, respectively.

(14) *Scan increment* means the amount of relative displacement of the patient with respect to the CT x-ray system between successive scans measured along the direction of such displacement.

(15) *Scan sequence* means a preselected set of two or more scans performed consecutively under preselected CT conditions of operations.

(16) *Sensitivity profile* means the relative response of the CT x-ray system as a function of position along a line perpendicular to the tomographic plane.

(17) *Single tomogram system* means a CT x-ray system which obtains x-ray transmission data during a scan to produce a single tomogram.

(18) *Tomographic plane* means that geometric plane which the manufacturer identifies as corresponding to the output tomogram.

(19) *Tomographic section* means the volume of an object whose x-ray attenuation properties are imaged in a tomogram.

(c) *Information to be provided for users.* Each manufacturer of a CT x-ray system shall provide the following technical and safety information, in addition to that required under §1020.30(h), to purchasers and, upon request, to others at a cost not to exceed the cost of publication and distribution of such information. This information shall be identified and provided in a separate section of the user’s instruction manual or in a separate manual devoted only to this information.

(1) *Conditions of operation.* A statement of the CT conditions of operation used to provide the information required by paragraph (c) (2) and (3) of this section.

(2) *Dose information.* The following dose information obtained by using the CT dosimetry phantom. For any CT x-ray system designed to image both the head and body, separate dose information shall be provided for each application. All dose measurements shall be

performed with the CT dosimetry phantom placed on the patient couch or support device without additional attenuating materials present.

(i) The CTDI at the following locations in the dosimetry phantom:

(a) Along the axis of rotation of the phantom.

(b) Along a line parallel to the axis of rotation and 1.0 centimeter interior to the surface of the phantom with the phantom positioned so that CTDI is the maximum obtainable at this depth.

(c) Along lines parallel to the axis of rotation and 1.0 centimeter interior to the surface of the phantom at positions 90, 180, and 270 degrees from the position in paragraph (c)(2)(i)(b) of this section. The CT conditions of operation shall be the typical values suggested by the manufacturer for CT of the head or body. The location of the position where the CTDI is maximum as specified in paragraph (c)(2)(i)(b) of this section shall be given by the manufacturer with respect to the housing of the scanning mechanism or other readily identifiable feature of the CT x-ray system in such a manner as to permit placement of the dosimetry phantom in this orientation.

(ii) The CTDI in the center location of the dosimetry phantom for each selectable CT condition of operation that varies either the rate or duration of x-ray exposure. This CTDI shall be presented as a value that is normalized to the CTDI in the center location of the dosimetry phantom from paragraph (c)(2)(i) of this section, with the CTDI of paragraph (c)(2)(i) of this section having a value of one. As each individual CT condition of operation is changed, all other independent CT conditions of operation shall be maintained at the typical values described in paragraph (c)(2)(i) of this section. These data shall encompass the range of each CT condition of operation stated by the manufacturer as appropriate for CT of the head or body. When more than three selections of a CT condition of operation are available, the normalized CTDI shall be provided, at least, for the minimum, maximum, and midrange value of the CT condition of operation.

(iii) The CTDI at the location coincident with the maximum CTDI at 1 cen-

timeter interior to the surface of the dosimetry phantom for each selectable peak tube potential. When more than three selections of peak tube potential are available, the normalized CTDI shall be provided, at least, for the minimum, maximum, and a typical value of peak tube potential. The CTDI shall be presented as a value that is normalized to the maximum CTDI located at 1 centimeter interior to the surface of the dosimetry phantom from paragraph (c)(2)(i) of this section, with the CTDI of paragraph (c)(2)(i) of this section having a value of one.

(iv) The dose profile in the center location of the dosimetry phantom for each selectable nominal tomographic section thickness. When more than three selections of nominal tomographic section thicknesses are available, the information shall be provided, at least, for the minimum, maximum, and midrange value of nominal tomographic section thickness. The dose profile shall be presented on the same graph and to the same scale as the corresponding sensitivity profile required by paragraph (c)(3)(iv) of this section.

(v) A statement of the maximum deviation from the values given in the information provided according to paragraph (c)(2) (i), (ii), (iii), and (iv) of this section. Deviation of actual values may not exceed these limits.

(3) *Imaging performance information.* The following performance data shall be provided for the CT conditions of operation used to provide the information required by paragraph (c)(2)(i) of this section. All other aspects of data collection, including the x-ray attenuation properties of the material in the tomographic section, shall be similar to those used to provide the dose information required by paragraph (c)(2)(i) of this section. For any CT x-ray system designed to image both the head and body, separate imaging performance information shall be provided for each application.

(i) A statement of the noise.

(ii) A graphical presentation of the modulation transfer function for the same image processing and display mode as that used in the statement of the noise.

(iii) A statement of the nominal tomographic section thickness(es).

(iv) A graphical presentation of the sensitivity profile, at the location corresponding to the center location of the dosimetry phantom, for each selectable nominal tomographic section thickness for which the dose profile is given according to paragraph (c)(2)(iv) of this section.

(v) A description of the phantom or device and test protocol or procedure used to determine the specifications and a statement of the maximum deviation from the specifications provided in accordance with paragraphs (c)(3)(i), (ii), (iii), and (iv) of this section. Deviation of actual values may not exceed these limits.

(d) *Quality assurance.* The manufacturer of any CT x-ray system shall provide the following with each system. All information required by this subsection shall be provided in a separate section of the user's instructional manual.

(1) A phantom(s) capable of providing an indication of contrast scale, noise, nominal tomographic section thickness, the spatial resolution capability of the system for low and high contrast objects, and measuring the mean CT number of water or a reference material.

(2) Instructions on the use of the phantom(s) including a schedule of testing appropriate for the system, allowable variations for the indicated parameters, and a method to store as records, quality assurance data.

(3) Representative images obtained with the phantom(s) using the same processing mode and CT conditions of operation as in paragraph (c)(3) of this section for a properly functioning system of the same model. The representative images shall be of two forms as follows:

(i) Photographic copies of the images obtained from the image display device.

(ii) Images stored in digital form on a storage medium compatible with the CT x-ray system. The CT x-ray system shall be provided with the means to display these images on the image display device.

(e) [Reserved]

(f) *Control and indication of conditions of operation—(1) Visual indication.* The CT conditions of operation to be used

during a scan or a scan sequence shall be indicated prior to initiation of a scan or a scan sequence. On equipment having all or some of these conditions of operation at fixed values, this requirement may be met by permanent markings. Indication of the CT conditions of operation shall be visible from any position from which scan initiation is possible.

(2) *Timers.* (i) Means shall be provided to terminate the x-ray exposure automatically by either deenergizing the x-ray source or shuttering the x-ray beam in the event of equipment failure affecting data collection. Such termination shall occur within an interval that limits the total scan time to no more than 110 percent of its preset value through the use of either a backup timer or devices which monitor equipment function. A visible signal shall indicate when the x-ray exposure has been terminated through these means and manual resetting of the CT conditions of operation shall be required prior to the initiation of another scan.

(ii) Means shall be provided so that the operator can terminate the x-ray exposure at any time during a scan, or series of scans under x-ray system control, of greater than one-half second duration. Termination of the x-ray exposure shall necessitate resetting of the CT conditions of operation prior to the initiation of another scan.

(g) *Tomographic plane indication and alignment.* (1) For any single tomogram system, means shall be provided to permit visual determination of the tomographic plane or a reference plane offset from the tomographic plane.

(2) For any multiple tomogram system, means shall be provided to permit visual determination of the location of a reference plane. The relationship of the reference plane to the planes of the tomograms shall be provided to the user in addition to other information provided according to §1020.30(h). This reference plane can be offset from the location of the tomographic planes.

(3) The distance between the indicated location of the tomographic plane or reference plane and its actual location may not exceed 5 millimeters.

(4) For any offset alignment system, the manufacturer shall provide specific

instructions with respect to the use of this system for patient positioning, in addition to other information provided according to §1020.30(h).

(5) If a mechanism using a light source is used to satisfy the requirements of paragraphs (g) (1) and (2) of this section, the light source shall allow visual determination of the location of the tomographic plane or reference plane under ambient light conditions of up to 500 lux.

(h) *Beam-on and shutter status indicators.* (1) Means shall be provided on the control and on or near the housing of the scanning mechanism to provide visual indication when and only when x rays are produced and, if applicable, whether the shutter is open or closed. If the x-ray production period is less than one-half second, the indication of x-ray production shall be actuated for one-half second. Indicators at or near the housing of the scanning mechanism shall be discernible from any point external to the patient opening where insertion of any part of the human body into the primary beam is possible.

(2) For systems that allow high voltage to be applied to the x-ray tube continuously and that control the emission of x-ray with a shutter, the radiation emitted may not exceed 0.88 milligray (vice 100 milliroentgen exposure) in 1 hour at any point 5 cm outside the external surface of the housing of the scanning mechanism when the shutter is closed. Compliance shall be determined by measurements average over an area of 100 square cm with no linear dimension greater than 20 cm.

(i) *Scan increment accuracy.* The deviation of indicated scan increment from actual scan increment may not exceed 1 millimeter. Compliance shall be measured as follows: The determination of the deviation of indicated versus actual scan increment shall be based on measurements taken with a mass 100 kilograms or less, on the patient support device. The patient support device shall be incremented from a typical starting position to the maximum incrementation distance or 30 centimeters, whichever is less, and then returned to the starting position. Measurement of actual versus indicated scan increment may be taken anywhere along this travel.

(j) *CT number mean and standard deviation.* (1) A method shall be provided to calculate the mean and standard deviation of CT numbers for an array of picture elements about any location in the image. The number of elements in this array shall be under user control.

(2) The manufacturer shall provide specific instructions concerning the use of the method provided for calculation of CT number mean and standard deviation in addition to other information provided according to §1020.30(h).

[49 FR 34712, Aug. 31, 1984; 49 FR 37381, Sept. 24, 1984, as amended at 49 FR 47388, Dec. 4, 1984; 56 FR 36098, Aug. 1, 1991; 67 FR 9587, Mar. 4, 2002; 70 FR 34042, June 10, 2005]

#### § 1020.40 Cabinet x-ray systems.

(a) *Applicability.* The provisions of this section are applicable to cabinet x-ray systems manufactured or assembled on or after April 10, 1975, except that the provisions as applied to x-ray systems designed primarily for the inspection of carry-on baggage are applicable to such systems manufactured or assembled on or after April 25, 1974. The provisions of this section are not applicable to systems which are designed exclusively for microscopic examination of material, e.g., x-ray diffraction, spectroscopic, and electron microscope equipment or to systems for intentional exposure of humans to x-rays.

(b) *Definitions.* As used in this section the following definitions apply:

(1) *Access panel* means any barrier or panel which is designed to be removed or opened for maintenance or service purposes, requires tools to open, and permits access to the interior of the cabinet.

(2) *Aperture* means any opening in the outside surface of the cabinet, other than a port, which remains open during generation of x radiation.

(3) *Cabinet x-ray system* means an x-ray system with the x-ray tube installed in an enclosure (hereinafter termed *cabinet*) which, independently of existing architectural structures except the floor on which it may be placed, is intended to contain at least that portion of a material being irradiated, provide radiation attenuation, and exclude personnel from its interior

during generation of x radiation. Included are all x-ray systems designed primarily for the inspection of carry-on baggage at airline, railroad, and bus terminals, and in similar facilities. An x-ray tube used within a shielded part of a building, or x-ray equipment which may temporarily or occasionally incorporate portable shielding is not considered a cabinet x-ray system.

(4) *Door* means any barrier which is designed to be movable or opened for routine operation purposes, does not generally require tools to open, and permits access to the interior of the cabinet. For the purposes of paragraph (c)(4)(i) of this section, inflexible hardware rigidly affixed to the door shall be considered part of the door.

(5) *Exposure* means the quotient of dQ by dm where dQ is the absolute value of the total charge of the ions of one sign produced in air when all the electrons (negatrons and positrons) liberated by photons in a volume element of air having mass dm are completely stopped in air.

(6) *External surface* means the outside surface of the cabinet x-ray system, including the high-voltage generator, doors, access panels, latches, control knobs, and other permanently mounted hardware and including the plane across any aperture or port.

(7) *Floor* means the underside external surface of the cabinet.

(8) *Ground fault* means an accidental electrical grounding of an electrical conductor.

(9) *Port* means any opening in the outside surface of the cabinet which is designed to remain open, during generation of x-rays, for the purpose of conveying material to be irradiated into and out of the cabinet, or for partial insertion for irradiation of an object whose dimensions do not permit complete insertion into the cabinet.

(10) *Primary beam* means the x radiation emitted directly from the target and passing through the window of the x-ray tube.

(11) *Safety interlock* means a device which is intended to prevent the generation of x radiation when access by any part of the human body to the interior of the cabinet x-ray system through a door or access panel is possible.

(12) *X-ray system* means an assemblage of components for the controlled generation of x-rays.

(13) *X-ray tube* means any electron tube which is designed for the conversion of electrical energy into x-ray energy.

(c) *Requirements*—(1) *Emission limit*. (i) Radiation emitted from the cabinet x-ray system shall not exceed an exposure of 0.5 milliroentgen in one hour at any point five centimeters outside the external surface.

(ii) Compliance with the exposure limit in paragraph (c)(1)(i) of this section shall be determined by measurements averaged over a cross-sectional area of ten square centimeters with no linear dimension greater than 5 centimeters, with the cabinet x-ray system operated at those combinations of x-ray tube potential, current, beam orientation, and conditions of scatter radiation which produce the maximum x-ray exposure at the external surface, and with the door(s) and access panel(s) fully closed as well as fixed at any other position(s) which will allow the generation of x radiation.

(2) *Floors*. A cabinet x-ray system shall have a permanent floor. Any support surface to which a cabinet x-ray system is permanently affixed may be deemed the floor of the system.

(3) *Ports and apertures*. (i) The insertion of any part of the human body through any port into the primary beam shall not be possible.

(ii) The insertion of any part of the human body through any aperture shall not be possible.

(4) *Safety interlocks*. (i) Each door of a cabinet x-ray system shall have a minimum of two safety interlocks. One, but not both of the required interlocks shall be such that door opening results in physical disconnection of the energy supply circuit to the high-voltage generator, and such disconnection shall not be dependent upon any moving part other than the door.

(ii) Each access panel shall have at least one safety interlock.

(iii) Following interruption of x-ray generation by the functioning of any safety interlock, use of a control provided in accordance with paragraph



(c)(6)(ii) of this section shall be necessary for resumption of x-ray generation.

(iv) Failure of any single component of the cabinet x-ray system shall not cause failure of more than one required safety interlock.

(5) *Ground fault.* A ground fault shall not result in the generation of x-rays.

(6) *Controls and indicators for all cabinet x-ray systems.* For all systems to which this section is applicable there shall be provided:

(i) A key-actuated control to insure that x-ray generation is not possible with the key removed.

(ii) A control or controls to initiate and terminate the generation of x-rays other than by functioning of a safety interlock or the main power control.

(iii) Two independent means which indicate when and only when x-rays are being generated, unless the x-ray generation period is less than one-half second, in which case the indicators shall be activated for one-half second, and which are discernible from any point at which initiation of x-ray generation is possible. Failure of a single component of the cabinet x-ray system shall not cause failure of both indicators to perform their intended function. One, but not both, of the indicators required by this subdivision may be a milliammeter labeled to indicate x-ray tube current. All other indicators shall be legibly labeled "X-RAY ON".

(iv) Additional means other than milliammeters which indicate when and only when x-rays are being generated, unless the x-ray generation period is less than one-half second in which case the indicators shall be activated for one-half second, as needed to insure that at least one indicator is visible from each door, access panel, and port, and is legibly labeled "X-RAY ON".

(7) *Additional controls and indicators for cabinet x-ray systems designed to admit humans.* For cabinet x-ray systems designed to admit humans there shall also be provided:

(i) A control within the cabinet for preventing and terminating x-ray generation, which cannot be reset, overridden or bypassed from the outside of the cabinet.

(ii) No means by which x-ray generation can be initiated from within the cabinet.

(iii) Audible and visible warning signals within the cabinet which are actuated for at least 10 seconds immediately prior to the first initiation of x-ray generation after closing any door designed to admit humans. Failure of any single component of the cabinet x-ray system shall not cause failure of both the audible and visible warning signals.

(iv) A visible warning signal within the cabinet which remains actuated when and only when x-rays are being generated, unless the x-ray generation period is less than one-half second in which case the indicators shall be activated for one-half second.

(v) Signs indicating the meaning of the warning signals provided pursuant to paragraphs (c)(7) (iii) and (iv) of this section and containing instructions for the use of the control provided pursuant to paragraph (c)(7)(i) of this section. These signs shall be legible, accessible to view, and illuminated when the main power control is in the "on" position.

(8) *Warning labels.* (i) There shall be permanently affixed or inscribed on the cabinet x-ray system at the location of any controls which can be used to initiate x-ray generation, a clearly legible and visible label bearing the statement:

CAUTION: X-RAYS PRODUCED WHEN  
ENERGIZED

(ii) There shall be permanently affixed or inscribed on the cabinet x-ray system adjacent to each port a clearly legible and visible label bearing the statement:

CAUTION: DO NOT INSERT ANY PART OF  
THE BODY WHEN SYSTEM IS ENER-  
GIZED—X-RAY HAZARD

(9) *Instructions.* (i) Manufacturers of cabinet x-ray systems shall provide for purchasers, and to others upon request at a cost not to exceed the cost of preparation and distribution, manuals and instructions which shall include at least the following technical and safety information: Potential, current, and duty cycle ratings of the x-ray generation equipment; adequate instructions

concerning any radiological safety procedures and precautions which may be necessary because of unique features of the system; and a schedule of maintenance necessary to keep the system in compliance with this section.

(ii) Manufacturers of cabinet x-ray systems which are intended to be assembled or installed by the purchaser shall provide instructions for assembly, installation, adjustment and testing of the cabinet x-ray system adequate to assure that the system is in compliance with applicable provisions of this section when assembled, installed, adjusted and tested as directed.

(10) *Additional requirements for x-ray baggage inspection systems.* X-ray systems designed primarily for the inspection of carry-on baggage at airline, railroad, and bus terminals, and at similar facilities, shall be provided with means, pursuant to paragraphs (c)(10) (i) and (ii) of this section, to insure operator presence at the control area in a position which permits surveillance of the ports and doors during generation of x-radiation.

(i) During an exposure or preset succession of exposures of one-half second or greater duration, the means provided shall enable the operator to terminate the exposure or preset succession of exposures at any time.

(ii) During an exposure or preset succession of exposures of less than one-half second duration, the means provided may allow completion of the exposure in progress but shall enable the operator to prevent additional exposures.

(d) *Modification of a certified system.* The modification of a cabinet x-ray system, previously certified pursuant to §1010.2 by any person engaged in the business of manufacturing, assembling or modifying cabinet x-ray systems shall be construed as manufacturing under the act if the modification affects any aspect of the system's performance for which this section has an applicable requirement. The manufacturer who performs such modification shall recertify and reidentify the system in accordance with the provisions of §§1010.2 and 1010.3 of this chapter.

[39 FR 12986, Apr. 10, 1974]

## PART 1030—PERFORMANCE STANDARDS FOR MICROWAVE AND RADIO FREQUENCY EMITTING PRODUCTS

AUTHORITY: 21 U.S.C. 351, 352, 360, 360e-360j, 360hh-360ss, 371, 381.

### § 1030.10 Microwave ovens.

(a) *Applicability.* The provisions of this standard are applicable to microwave ovens manufactured after October 6, 1971.

(b) *Definitions*—(1) *Microwave oven* means a device designed to heat, cook, or dry food through the application of electromagnetic energy at frequencies assigned by the Federal Communications Commission in the normal ISM heating bands ranging from 890 megahertz to 6,000 megahertz. As defined in this standard, "microwave ovens" are limited to those manufactured for use in homes, restaurants, food vending, or service establishments, on interstate carriers, and in similar facilities.

(2) *Cavity* means that portion of the microwave oven in which food may be heated, cooked, or dried.

(3) *Door* means the movable barrier which prevents access to the cavity during operation and whose function is to prevent emission of microwave energy from the passage or opening which provides access to the cavity.

(4) *Safety interlock* means a device or system of devices which is intended to prevent generation of microwave energy when access to the cavity is possible.

(5) *Service adjustments or service procedures* means those servicing methods prescribed by the manufacturer for a specific product model.

(6) *Stirrer* means that feature of a microwave oven which is intended to provide uniform heating of the load by constantly changing the standing wave pattern within the cavity or moving the load.

(7) *External surface* means the outside surface of the cabinet or enclosure provided by the manufacturer as part of the microwave oven, including doors, door handles, latches, and control knobs.

(8) *Equivalent plane-wave power density* means the square of the root-mean-

square (rms) electric field strength divided by the impedance of free space (377 ohms).

(c) *Requirements*—(1) *Power density limit*. The equivalent plane-wave power density existing in the proximity of the external oven surface shall not exceed 1 milliwatt per square centimeter at any point 5 centimeters or more from the external surface of the oven, measured prior to acquisition by a purchaser, and, thereafter, 5 milliwatts per square centimeter at any such point.

(2) *Safety interlocks*. (i) Microwave ovens shall have a minimum of two operative safety interlocks. At least one operative safety interlock on a fully assembled microwave oven shall not be operable by any part of the human body, or any object with a straight insertable length of 10 centimeters. Such interlock must also be concealed, unless its actuation is prevented when access to the interlock is possible. Any visible actuator or device to prevent actuation of this safety interlock must not be removable without disassembly of the oven or its door. A magnetically operated interlock is considered to be concealed, or its actuation is considered to be prevented, only if a test magnet held in place on the oven by gravity or its own attraction cannot operate the safety interlock. The test magnet shall be capable of lifting vertically at zero air gap at least 4.5 kilograms, and at 1 centimeter air gap at least 450 grams when the face of the magnet, which is toward the interlock when the magnet is in the test position, is pulling against one of the large faces of a mild steel armature having dimensions of 80 millimeters by 50 millimeters by 8 millimeters.

(ii) Failure of any single mechanical or electrical component of the microwave oven shall not cause all safety interlocks to be inoperative.

(iii) Service adjustments or service procedures on the microwave oven shall not cause the safety interlocks to become inoperative or the microwave radiation emission to exceed the power density limits of this section as a result of such service adjustments or procedures.

(iv) Microwave radiation emission in excess of the limits specified in paragraph (c)(1) of this section shall not be

caused by insertion of an insulated wire through any opening in the external surfaces of a fully assembled oven into the cavity, waveguide, or other microwave-energy-containing spaces while the door is closed, provided the wire, when inserted, could consist of two straight segments forming an obtuse angle of not less than 170 degrees.

(v) One (the primary) required safety interlock shall prevent microwave radiation emission in excess of the requirement of paragraph (c)(1) of this section; the other (secondary) required safety interlock shall prevent microwave radiation emission in excess of 5 milliwatts per square centimeter at any point 5 centimeters or more from the external surface of the oven. The two required safety interlocks shall be designated as primary or secondary in the service instructions for the oven.

(vi) A means of monitoring one or both of the required safety interlocks shall be provided which shall cause the oven to become inoperable and remain so until repaired if the required safety interlock(s) should fail to perform required functions as specified in this section. Interlock failures shall not disrupt the monitoring function.

(3) *Measurement and test conditions*. (i) Compliance with the power density limit in paragraph (c)(1) of this section shall be determined by measurement of the equivalent plane-wave power density made with an instrument which reaches 90 percent of its steady-state reading within 3 seconds, when the system is subjected to a step-function input signal. Tests for compliance shall account for all measurement errors and uncertainties to ensure that the equivalent plane-wave power density does not exceed the limit prescribed by paragraph (c)(1) of this section.

(ii) Microwave ovens shall be in compliance with the power density limits if the maximum reading obtained at the location of greatest microwave radiation emission, taking into account all measurement errors and uncertainties, does not exceed the limit specified in paragraph (c)(1) of this section, when the emission is measured through at least one stirrer cycle. As provided in §1010.13 of this chapter, a manufacturer

may request alternative test procedures if, as a result of the stirrer characteristics of a microwave oven, such oven is not susceptible to testing by the procedures described in this paragraph.

(iii) Measurements shall be made with the microwave oven operating at its maximum output and containing a load of 275 ±15 milliliters of tap water initially at 20 ±5 °centigrade placed within the cavity at the center of the load-carrying surface provided by the manufacturer. The water container shall be a low form 600-milliliter beaker having an inside diameter of approximately 8.5 centimeters and made of an electrically nonconductive material such as glass or plastic.

(iv) Measurements shall be made with the door fully closed as well as with the door fixed in any other position which allows the oven to operate.

(4) *User instructions.* Manufacturers of microwave ovens to which this section is applicable shall provide, or cause to be provided, with each oven, radiation safety instructions which:

(i) Occupy a separate section and are an integral part of the regularly supplied users' manual and cookbook, if supplied separately, and are located so as to elicit the attention of the reader.

(ii) Are as legible and durable as other instructions with the title emphasized to elicit the attention of the reader by such means as bold-faced type, contrasting color, a heavy-lined border, or by similar means.

(iii) Contain the following wording:

PRECAUTIONS TO AVOID POSSIBLE EXPOSURE  
TO EXCESSIVE MICROWAVE ENERGY

(a) Do not attempt to operate this oven with the door open since open-door operation can result in harmful exposure to microwave energy. It is important not to defeat or tamper with the safety interlocks.

(b) Do not place any object between the oven front face and the door or allow soil or cleaner residue to accumulate on sealing surfaces.

(c) Do not operate the oven if it is damaged. It is particularly important that the oven door close properly and that there is no damage to the: (1) Door (bent), (2) hinges and latches (broken or loosened), (3) door seals and sealing surfaces.

(d) The oven should not be adjusted or repaired by anyone except properly qualified service personnel.

(iv) Include additional radiation safety precautions or instructions which may be necessary for particular oven designs or models, as determined by the Director, Center for Devices and Radiological Health or the manufacturer.

(5) *Service instructions.* Manufacturers of microwave ovens to which this section is applicable shall provide or cause to be provided to servicing dealers and distributors and to others upon request, for each oven model, adequate instructions for service adjustments and service procedures, and, in addition, radiation safety instructions which:

(i) Occupy a separate section and are an integral part of the regularly supplied service manual and are located so as to elicit the attention of the reader.

(ii) Are as legible and durable as other instructions with the title emphasized so as to elicit the attention of the reader by such means as bold-faced type, contrasting color, a heavy-lined border, or by similar means.

(iii) Contain the following wording:

PRECAUTIONS TO BE OBSERVED BEFORE AND  
DURING SERVICING TO AVOID POSSIBLE EX-  
POSURE TO EXCESSIVE MICROWAVE ENERGY

(a) Do not operate or allow the oven to be operated with the door open.

(b) Make the following safety checks on all ovens to be serviced before activating the magnetron or other microwave source, and make repairs as necessary: (1) Interlock operation, (2) proper door closing, (3) seal and sealing surfaces (arcing, wear, and other damage), (4) damage to or loosening of hinges and latches, (5) evidence of dropping or abuse.

(c) Before turning on microwave power for any service test or inspection within the microwave generating compartments, check the magnetron, wave guide or transmission line, and cavity for proper alignment, integrity, and connections.

(d) Any defective or misadjusted components in the interlock, monitor, door seal, and microwave generation and transmission systems shall be repaired, replaced, or adjusted by procedures described in this manual before the oven is released to the owner.

(e) A Microwave leakage check to verify compliance with the Federal performance standard should be performed on each oven prior to release to the owner.

(iv) Include additional radiation safety precautions or instructions which may be necessary for particular oven

designs or models, as determined by the Director, Center for Devices and Radiological Health or the manufacturer.

(6) *Warning labels.* Except as provided in paragraph (c)(6)(iv) of this section, microwave ovens shall have the following warning labels:

(i) A label, permanently attached to or inscribed on the oven, which shall be legible and readily viewable during normal oven use, and which shall have the title emphasized and be so located as to elicit the attention of the user. The label shall bear the following warning statement:

PRECAUTIONS FOR SAFE USE TO AVOID POSSIBLE EXPOSURE TO EXCESSIVE MICROWAVE ENERGY

DO NOT Attempt to Operate This Oven With:

- (a) Object Caught in Door.
- (b) Door That Does Not Close Properly.
- (c) Damaged Door, Hinge, Latch, or Sealing Surface.

(ii) A label, permanently attached to or inscribed on the external surface of the oven, which shall be legible and readily viewable during servicing, and which shall have the word "CAUTION" emphasized and be so located as to elicit the attention of service personnel. The label shall bear the following warning statement:

CAUTION: This Device is to be Serviced Only by Properly Qualified Service Personnel. Consult the Service Manual for Proper Service Procedures to Assure Continued Compliance with the Federal Performance Standard for Microwave Ovens and for Precautions to be Taken to Avoid Possible Exposure to Excessive Microwave Energy.

(iii) The labels provided in accordance with paragraphs (c)(6)(i) and (ii) of this section shall bear only the statements specified in that paragraph, except for additional radiation safety warnings or instructions which may be necessary for particular oven designs or models, as determined by the Director, Center for Devices and Radiological Health or the manufacturer.

(iv) Upon application by a manufacturer, the Director, Center for Devices and Radiological Health, Food and Drug Administration, may grant an exemption from one or more of the statements (radiation safety warnings) specified in paragraph (c)(6)(i) of this sec-

tion. Such exemption shall be based upon a determination by the Director that the microwave oven model for which the exemption is sought should continue to comply with paragraphs (c) (1), (2), and (3) of this section under the adverse condition of use addressed by such precautionary statement(s). An original and two copies of applications shall be submitted to the Division of Dockets Management (HFA-305), Food and Drug Administration, 5630 Fishers Lane, rm. 1061, Rockville, MD 20852. Copies of the written portion of the application, including supporting data and information, and the Director's action on the application will be maintained by the Branch for public review. The application shall include:

(a) The specific microwave oven model(s) for which the exemption is sought.

(b) The specific radiation safety warning(s) from which exemption is sought.

(c) Data and information which clearly establish that one or more of the radiation safety warnings in paragraph (c)(6)(i) of this section is not necessary for the specified microwave oven model(s).

(d) Such other information and a sample of the applicable product if required by regulation or by the Director, Center for Devices and Radiological Health, to evaluate and act on the application.

[38 FR 28640, Oct. 15, 1973, as amended at 40 FR 14752, Apr. 4, 1975; 40 FR 52007, Nov. 7, 1975; 46 FR 8461, Jan. 27, 1981; 48 FR 57482, Dec. 30, 1983; 50 FR 13566, Apr. 5, 1985; 53 FR 11254, Apr. 6, 1988; 59 FR 14365, Mar. 28, 1994]

## PART 1040—PERFORMANCE STANDARDS FOR LIGHT-EMITTING PRODUCTS

Sec.

1040.10 Laser products.

1040.11 Specific purpose laser products.

1040.20 Sunlamp products and ultraviolet lamps intended for use in sunlamp products.

1040.30 High-intensity mercury vapor discharge lamps.

AUTHORITY: 21 U.S.C. 351, 352, 360, 360e-360j, 360hh-360ss, 371, 381.

## § 1040.10

## 21 CFR Ch. I (4-1-20 Edition)

### § 1040.10 Laser products.

(a) *Applicability.* The provisions of this section and § 1040.11, as amended, are applicable as specified to all laser products manufactured or assembled after August 1, 1976, except when:

(1) Such a laser product is either sold to a manufacturer of an electronic product for use as a component (or replacement) in such electronic product, or

(2) Sold by or for a manufacturer of an electronic product for use as a component (or replacement) in such electronic product, provided that such laser product:

(i) Is accompanied by a general warning notice that adequate instructions for the safe installation of the laser product are provided in servicing information available from the complete laser product manufacturer under paragraph (h)(2)(ii) of this section, and should be followed,

(ii) Is labeled with a statement that it is designated for use solely as a component of such electronic product and therefore does not comply with the appropriate requirements of this section and § 1040.11 for complete laser products, and

(iii) Is not a removable laser system as described in paragraph (c)(2) of this section; and

(3) The manufacturer of such a laser product, if manufactured after August 20, 1986:

(i) Registers, and provides a listing by type of such laser products manufactured that includes the product name, model number, and laser medium or emitted wavelength(s), and the name and address of the manufacturer. The manufacturer must submit the registration and listing to the Director, Center for Devices and Radiological Health, Food and Drug Administration, 10903 New Hampshire Ave., Bldg. 66, Silver Spring, MD 20993-0002.

(ii) Maintains and allows access to any sales, shipping, or distribution records that identify the purchaser of such a laser product by name and address, the product by type, the number of units sold, and the date of sale (shipment). These records shall be maintained and made available as specified in § 1002.31.

(b) *Definitions.* As used in this section and § 1040.11, the following definitions apply:

(1) *Accessible emission level* means the magnitude of accessible laser or collateral radiation of a specific wavelength and emission duration at a particular point as measured according to paragraph (e) of this section. Accessible laser or collateral radiation is radiation to which human access is possible, as defined in paragraphs (b) (12), (15), and (22) of this section.

(2) *Accessible emission limit* means the maximum accessible emission level permitted within a particular class as set forth in paragraphs (c), (d), and (e) of this section.

(3) *Aperture* means any opening in the protective housing or other enclosure of a laser product through which laser or collateral radiation is emitted, thereby allowing human access to such radiation.

(4) *Aperture stop* means an opening serving to limit the size and to define the shape of the area over which radiation is measured.

(5) *Class I laser product* means any laser product that does not permit access during the operation to levels of laser radiation in excess of the accessible emission limits contained in table I of paragraph (d) of this section.<sup>1</sup>

(6) *Class IIa laser product* means any laser product that permits human access during operation to levels of visible laser radiation in excess of the accessible emission limits contained in table I, but does not permit human access during operation to levels of laser radiation in excess of the accessible emission limits contained in table II-A of paragraph (d) of this section.<sup>2</sup>

(7) *Class II laser product* means any laser product that permits human access during operation to levels of visible laser radiation in excess of the accessible emission limits contained in table II-A, but does not permit human access during operation to levels of

<sup>1</sup>Class I levels of laser radiation are not considered to be hazardous.

<sup>2</sup>Class IIa levels of laser radiation are not considered to be hazardous if viewed for any period of time less than or equal to  $1 \times 10^3$  seconds but are considered to be a chronic viewing hazard for any period of time greater than  $1 \times 10^3$  seconds.

laser radiation in excess of the accessible emission limits contained in table II of paragraph (d) of this section.<sup>3</sup>

(8) *Class IIIa laser product* means any laser product that permits human access during operation to levels of visible laser radiation in excess of the accessible emission limits contained in table II, but does not permit human access during operation to levels of laser radiation in excess of the accessible emission limits contained in table III-A of paragraph (d) of this section.<sup>4</sup>

(9) *Class IIIb laser product* means any laser product that permits human access during operation to levels of laser radiation in excess of the accessible emission limits of table III-A, but does not permit human access during operation to levels of laser radiation in excess of the accessible emission limits contained in table III-B of paragraph (d) of this section.<sup>5</sup>

(10) *Class III laser product* means any Class IIIa or Class IIIb laser product.

(11) *Class IV laser product* means any laser that permits human access during operation to levels of laser radiation in excess of the accessible emission limits contained in table III-B of paragraph (d) of this section.<sup>6</sup>

(12) *Collateral radiation* means any electronic product radiation, except laser radiation, emitted by a laser product as a result of the operation of the laser(s) or any component of the laser product that is physically necessary for the operation of the laser(s).

(13) *Demonstration laser product* means any laser product manufactured, designed, intended, or promoted for purposes of demonstration, entertainment, advertising display, or artistic composition. The term "demonstration laser product" does not apply to laser products which are not manufactured,

designed, intended, or promoted for such purposes, even though they may be used for those purposes or are intended to demonstrate other applications.

(14) *Emission duration* means the temporal duration of a pulse, a series of pulses, or continuous operation, expressed in seconds, during which human access to laser or collateral radiation could be permitted as a result of operation, maintenance, or service of a laser product.

(15) *Human access* means the capacity to intercept laser or collateral radiation by any part of the human body. For laser products that contain Class IIIb or IV levels of laser radiation, "human access" also means access to laser radiation that can be reflected directly by any single introduced flat surface from the interior of the product through any opening in the protective housing of the product.

(16) *Integrated radiance* means radiant energy per unit area of a radiating surface per unit solid angle of emission, expressed in joules per square centimeter per steradian ( $\text{Jcm}^{-2} \text{sr}^{-1}$ ).

(17) *Invisible radiation* means laser or collateral radiation having wavelengths of equal to or greater than 180 nm but less than or equal to 400 nm or greater than 710 nm but less than or equal to  $1.0 \times 10^6$  nm (1 millimeter).

(18) *Irradiance* means the time-averaged radiant power incident on an element of a surface divided by the area of that element, expressed in watts per square centimeter ( $\text{W cm}^{-2}$ ).

(19) *Laser* means any device that can be made to produce or amplify electromagnetic radiation at wavelengths greater than 250 nm but less than or equal to 13,000 nm or, after August 20, 1986, at wavelengths equal to or greater than 180 nm but less than or equal to  $1.0 \times 10^6$  nm primarily by the process of controlled stimulated emission.

(20) *Laser energy source* means any device intended for use in conjunction with a laser to supply energy for the operation of the laser. General energy sources such as electrical supply mains or batteries shall not be considered to constitute laser energy sources.

<sup>3</sup>Class II levels of laser radiation are considered to be a chronic viewing hazard.

<sup>4</sup>Class IIIa levels of laser radiation are considered to be, depending upon the irradiance, either an acute intrabeam viewing hazard or chronic viewing hazard, and an acute viewing hazard if viewed directly with optical instruments.

<sup>5</sup>Class IIIb levels of laser radiation are considered to be an acute hazard to the skin and eyes from direct radiation.

<sup>6</sup>Class IV levels of laser radiation are considered to be an acute hazard to the skin and eyes from direct and scattered radiation.

## § 1040.10

## 21 CFR Ch. I (4-1-20 Edition)

(21) *Laser product* means any manufactured product or assemblage of components which constitutes, incorporates, or is intended to incorporate a laser or laser system. A laser or laser system that is intended for use as a component of an electronic product shall itself be considered a laser product.

(22) *Laser radiation* means all electromagnetic radiation emitted by a laser product within the spectral range specified in paragraph (b)(19) of this section that is produced as a result of controlled stimulated emission or that is detectable with radiation so produced through the appropriate aperture stop and within the appropriate solid angle of acceptance, as specified in paragraph (e) of this section.

(23) *Laser system* means a laser in combination with an appropriate laser energy source with or without additional incorporated components. See paragraph (c)(2) of this section for an explanation of the term "removable laser system."

(24) *Maintenance* means performance of those adjustments or procedures specified in user information provided by the manufacturer with the laser product which are to be performed by the user for the purpose of assuring the intended performance of the product. It does not include operation or service as defined in paragraph (b) (27) and (38) of this section.

(25) *Maximum output* means the maximum radiant power and, where applicable, the maximum radiant energy per pulse of accessible laser radiation emitted by a laser product during operation, as determined under paragraph (e) of this section.

(26) *Medical laser product* means any laser product which is a medical device as defined in 21 U.S.C. 321(h) and is manufactured, designed, intended or promoted for in vivo laser irradiation of any part of the human body for the purpose of: (i) Diagnosis, surgery, or therapy; or (ii) relative positioning of the human body.

(27) *Operation* means the performance of the laser product over the full range of its functions. It does not include maintenance or service as defined in paragraphs (b) (24) and (38) of this section.

(28) *Protective housing* means those portions of a laser product which are designed to prevent human access to laser or collateral radiation in excess of the prescribed accessible emission limits under conditions specified in this section and in §1040.11.

(29) *Pulse duration* means the time increment measured between the half-peak-power points at the leading and trailing edges of a pulse.

(30) *Radiance* means time-averaged radiant power per unit area of a radiating surface per unit solid angle of emission, expressed in watts per square centimeter per steradian ( $\text{W cm}^{-2} \text{sr}^{-1}$ ).

(31) *Radiant energy* means energy emitted, transferred or received in the form of radiation, expressed in joules (J).

(32) *Radiant exposure* means the radiant energy incident on an element of a surface divided by the area of the element, expressed in joules per square centimeter ( $\text{Jcm}^{-2}$ ).

(33) *Radiant power* means time-averaged power emitted, transferred or received in the form of radiation, expressed in watts (W).

(34) *Remote interlock connector* means an electrical connector which permits the connection of external remote interlocks.

(35) *Safety interlock* means a device associated with the protective housing of a laser product to prevent human access to excessive radiation in accordance with paragraph (f)(2) of this section.

(36) *Sampling interval* means the time interval during which the level of accessible laser or collateral radiation is sampled by a measurement process. The magnitude of the sampling interval in units of seconds is represented by the symbol ( $t$ ).

(37) *Scanned laser radiation* means laser radiation having a time-varying direction, origin or pattern of propagation with respect to a stationary frame of reference.

(38) *Service* means the performance of those procedures or adjustments described in the manufacturer's service instructions which may affect any aspect of the product's performance for



which this section and §1040.11 have applicable requirements. It does not include maintenance or operation as defined in paragraphs (b) (24) and (27) of this section.

(39) *Surveying, leveling, or alignment laser product* means a laser product manufactured, designed, intended or promoted for one or more of the following uses:

(i) Determining and delineating the form, extent, or position of a point, body, or area by taking angular measurement.

(ii) Positioning or adjusting parts in proper relation to one another.

(iii) Defining a plane, level, elevation, or straight line.

(40) *Visible radiation* means laser or collateral radiation having wavelengths of greater than 400 nm but less than or equal to 710 nm.

(41) *Warning logotype* means a logotype as illustrated in either figure 1 or figure 2 of paragraph (g) of this section.

(42) *Wavelength* means the propagation wavelength in air of electromagnetic radiation.

(c) *Classification of laser products*—(1) *All laser products*. Each laser product shall be classified in Class I, IIa, II, IIIa, IIIb, or IV in accordance with definitions set forth in paragraphs (b) (5) through (11) of this section. The product classification shall be based on the highest accessible emission level(s) of

laser radiation to which human access is possible during operation in accordance with paragraphs (d), (e), and (f)(1) of this section.

(2) *Removable laser systems*. Any laser system that is incorporated into a laser product subject to the requirements of this section and that is capable, without modification, of producing laser radiation when removed from such laser product, shall itself be considered a laser product and shall be separately subject to the applicable requirements in this subchapter for laser products of its class. It shall be classified on the basis of accessible emission of laser radiation when so removed.

(d) *Accessible emission limits*. Accessible emission limits for laser radiation in each class are specified in tables I, II-A, II, III-A, and III-B of this paragraph. The factors,  $k_1$  and  $k_2$  vary with wavelength and emission duration. These factors are given in table IV of this paragraph, with selected numerical values in table V of this paragraph. Accessible emission limits for collateral radiation are specified in table VI of this paragraph.

NOTES APPLICABLE TO TABLES I, II-A, II, III-A AND III-B: (1) The factors  $k_1$  and  $k_2$  are wavelength-dependent correction factors determined from table IV.

(2) The variable  $t$  in the expressions of emission limits is the magnitude of the sampling interval in units of seconds.

TABLE I  
CLASS I ACCESSIBLE EMISSION LIMITS FOR LASER RADIATION

Wavelength (nanometers)	Emission duration (seconds)	Class I-Accessible emission limits		
		(value)	(unit)	(quantity)**
>100 but <400	<3.0 X 10 <sup>4</sup>	2.4 X 10 <sup>-5</sup> k <sub>1</sub> k <sub>2</sub> *	Joules(J)*	radiant energy
	>3.0 X 10 <sup>4</sup>	8.0 X 10 <sup>-10</sup> k <sub>1</sub> k <sub>2</sub> *	Watts(W)*	radiant power
>400 but <1400	>1.0 X 10 <sup>-9</sup> to 2.0 X 10 <sup>-5</sup>	2.0 X 10 <sup>-7</sup> k <sub>1</sub> k <sub>2</sub>	J	radiant energy
	>2.0 X 10 <sup>-5</sup> to 1.0 X 10 <sup>1</sup>	7.0 X 10 <sup>-4</sup> k <sub>1</sub> k <sub>2</sub> t <sup>3/4</sup>	J	radiant energy
	>1.0 X 10 <sup>1</sup> to 1.0 X 10 <sup>4</sup>	3.9 X 10 <sup>-3</sup> k <sub>1</sub> k <sub>2</sub>	J	radiant energy
	>1.0 X 10 <sup>4</sup>	3.9 X 10 <sup>-7</sup> k <sub>1</sub> k <sub>2</sub>	W	radiant power
>1400 but <2500	>1.0 X 10 <sup>-9</sup> to 1.0 X 10 <sup>1</sup>	10k <sub>1</sub> k <sub>2</sub> t <sup>1/3</sup>	Jcm <sup>-2</sup> sr <sup>-1</sup>	integrated radiance
	>1.0 X 10 <sup>1</sup> to 1.0 X 10 <sup>4</sup>	20k <sub>1</sub> k <sub>2</sub>	Jcm <sup>-2</sup> sr <sup>-1</sup>	integrated radiance
	>1.0 X 10 <sup>4</sup>	2.0 X 10 <sup>-3</sup> k <sub>1</sub> k <sub>2</sub>	Wcm <sup>-2</sup> sr <sup>-1</sup>	radiance
	>1.0 X 10 <sup>-9</sup> to 1.0 X 10 <sup>-7</sup>	7.9 X 10 <sup>-5</sup> k <sub>1</sub> k <sub>2</sub>	J	radiant energy
>2500 but <1.0 X 10 <sup>6</sup>	>1.0 X 10 <sup>-7</sup> to 1.0 X 10 <sup>1</sup>	4.4 X 10 <sup>-3</sup> k <sub>1</sub> k <sub>2</sub> t <sup>1/4</sup>	J	radiant energy
	>1.0 X 10 <sup>1</sup>	7.9 X 10 <sup>-4</sup> k <sub>1</sub> k <sub>2</sub>	W	radiant power
>1.0 X 10 <sup>6</sup>	>1.0 X 10 <sup>-9</sup> to 1.0 X 10 <sup>-7</sup>	1.0 X 10 <sup>-2</sup> k <sub>1</sub> k <sub>2</sub>	Jcm <sup>-2</sup>	radiant exposure
	>1.0 X 10 <sup>-7</sup> to 1.0 X 10 <sup>1</sup>	5.6 X 10 <sup>-1</sup> k <sub>1</sub> k <sub>2</sub> t <sup>1/4</sup>	Jcm <sup>-2</sup>	radiant exposure
	>1.0 X 10 <sup>1</sup>	1.0 X 10 <sup>-1</sup> k <sub>1</sub> k <sub>2</sub> t	Jcm <sup>-2</sup>	radiant exposure

\*Class I accessible emission limits for wavelengths equal to or greater than 180 nm but less than or equal to 400 nm shall not exceed the Class I accessible emission limits for the wavelengths greater than 1400 nm but less than or equal to 1.0 X 10<sup>6</sup> nm with a k<sub>1</sub> and k<sub>2</sub> of 1.0 for comparable sampling intervals.

\*\*Measurement parameters and test conditions shall be in accordance with paragraphs (d)(1), (2), (3), and (4), and (e) of this section.

TABLE II-A  
CLASS IIa ACCESSIBLE EMISSION LIMITS FOR LASER RADIATION

CLASS IIa ACCESSIBLE EMISSION LIMITS ARE IDENTICAL TO CLASS I ACCESSIBLE EMISSION LIMITS EXCEPT WITHIN THE FOLLOWING RANGE OF WAVELENGTHS AND EMISSION DURATIONS:			
Wavelength (nanometers)	Emission duration (seconds)	Class IIa-Accessible emission limits	
		(value)	(unit) (quantity)*
>400 but ≤710	>1.0 X 10 <sup>3</sup>	3.9 X 10 <sup>-6</sup>	W radiant power

\*Measurement parameters and test conditions shall be in accordance with paragraphs (d)(1), (2), (3), and (4), and (e) of this section.

TABLE II  
CLASS II ACCESSIBLE EMISSION LIMITS FOR LASER RADIATION

CLASS II ACCESSIBLE EMISSION LIMITS ARE IDENTICAL TO CLASS I ACCESSIBLE EMISSION LIMITS EXCEPT WITHIN THE FOLLOWING RANGE OF WAVELENGTHS AND EMISSION DURATIONS:			
Wavelength (nanometers)	Emission duration (seconds)	Class II-Accessible emission limits	
		(value)	(unit) (quantity)*
>400 but ≤710	>2.5 X 10 <sup>-1</sup>	1.0 X 10 <sup>-3</sup>	W radiant power

\*Measurement parameters and test conditions shall be in accordance with paragraphs (d)(1), (2), (3), and (4), and (e) of this section.

TABLE III-A  
CLASS IIIa ACCESSIBLE EMISSION LIMITS FOR LASER RADIATION

Wavelength (nanometers)	Emission duration (seconds)	Class IIIa-Accessible emission limits		
		(value)	(unit)	(quantity)*
>400 but ≤710	>3.8 X 10 <sup>-4</sup>	5.0 X 10 <sup>-3</sup>	W	radiant power

\*Measurement parameters and test conditions shall be in accordance with paragraphs (d)(1), (2), (3), and (4), and (e) of this section.

TABLE III-B  
CLASS IIIB ACCESSIBLE EMISSION LIMITS FOR LASER RADIATION

Wavelength (nanometers)	Emission duration (seconds)	Class IIIB-Accessible emission limits		
		(value)	(unit)	(quantity)*
≥180 but ≤400	≤2.5 X 10 <sup>-1</sup> but >2.5 X 10 <sup>-1</sup>	3.8 X 10 <sup>-4</sup> k <sub>1</sub> k <sub>2</sub> 1.5 X 10 <sup>-2</sup> k <sub>1</sub> k <sub>2</sub>	J W	radiant energy radiant power
>400 but ≤1400	>1.0 X 10 <sup>-9</sup> to 2.5 X 10 <sup>-1</sup> to a maximum value of 10	10k <sub>1</sub> k <sub>2</sub> t <sup>1/3</sup> 5.0 X 10 <sup>-1</sup>	Jcm <sup>-2</sup> Jcm <sup>-2</sup>	radiant exposure radiant exposure
>1400 but ≤1.0 X 10 <sup>6</sup>	>2.5 X 10 <sup>-1</sup> >1.0 X 10 <sup>-9</sup> to 1.0 X 10 <sup>1</sup> >1.0 X 10 <sup>1</sup>	10 5.0 X 10 <sup>-1</sup>	W Jcm <sup>-2</sup>	radiant power radiant exposure
		5.0 X 10 <sup>-1</sup>	W	radiant power

\*Measurement parameter and test conditions shall be in accordance with paragraphs (d)(1), (2), (3), and (4), and (e) of this section.

TABLE IV  
VALUES OF WAVELENGTH DEPENDENT CORRECTION FACTORS  $k_1$  AND  $k_2$

Wavelength (nanometers)	$k_1$	$k_2$
180 to 302.4	1.0	1.0
> 302.4 to 315	$10^{\left[\frac{\lambda - 302.4}{5}\right]}$	1.0
> 315 to 400	330.0	1.0
> 400 to 700	1.0	1.0
> 700 to 800	$10^{\left[\frac{\lambda - 700}{515}\right]}$	if: $\frac{10100}{\lambda - 699} < t \leq 10^4$ then: $k_2 = \frac{10100}{t(\lambda - 699)}$
> 800 to 1060	$10^{\left[\frac{\lambda - 700}{515}\right]}$	if: $t \leq 10^4$ then: $k_2 = 1.0$
> 1060 to 1400	5.0	if: $100 < t \leq 10^4$ then: $k_2 = \frac{t}{100}$
> 1400 to 1535	1.0	1.0
> 1535 to 1545	$t \leq 10^{-7}$ $k_1 = 100.0$ $t > 10^{-7}$ $k_1 = 1.0$	1.0
> 1545 to $1.0 \times 10^6$	1.0	1.0

Note: The variables in the expressions are the magnitudes of the sampling interval (t), in units of seconds, and the wavelength ( $\lambda$ ), in units of nanometers.

TABLE V  
SELECTED NUMERICAL SOLUTIONS FOR  $k_1$  AND  $k_2$

Wavelength (nanometers)	$k_1$	$k_2$				
		$t \leq 100$	$t=300$	$t=1000$	$t=3000$	$t \geq 10,000$
180	1.0	1.0				
300	1.0					
302	1.0					
303	1.32					
304	2.09					
305	3.31					
306	5.25					
307	8.32					
308	13.2					
309	20.9					
310	33.1					
311	52.5					
312	83.2					
313	132.0					
314	209.0					
315	330.0					
400	330.0					
401	1.0					
500	1.0					
600	1.0					
700	1.0					
710	1.05	1	1	1.1	3.3	11.0
720	1.09	1	1	2.1	6.3	21.0
730	1.14	1	1	3.1	9.3	31.0
740	1.20	1	1.2	4.1	12.0	41.0
750	1.25	1	1.5	5.0	15.0	50.0
760	1.31	1	1.8	6.0	18.0	60.0
770	1.37	1	2.1	7.0	21.0	70.0
780	1.43	1	2.4	8.0	24.0	80.0
790	1.50	1	2.7	9.0	27.0	90.0
800	1.56	1	3.0	10.0	30.0	100.0
850	1.95	1	3.0	10.0	30.0	100.0
900	2.44	1	3.0	10.0	30.0	100.0
950	3.05	1	3.0	10.0	30.0	100.0
1000	3.82	1	3.0	10.0	30.0	100.0
1050	4.78	1	3.0	10.0	30.0	100.0
1060	5.00	1	3.0	10.0	30.0	100.0
1100	5.00	1	3.0	10.0	30.0	100.0
1400	5.00	1	3.0	10.0	30.0	100.0
1500	1.0	1.0				
1540	100.0*					
1600	1.0					
$1.0 \times 10^6$	1.0					

\* The factor  $k_1 = 100.0$  when  $t \leq 10^{-7}$ , and  $k_1 = 1.0$  when  $t > 10^{-7}$

Note: The variable (t) is the magnitude of the sampling interval in units of seconds.

TABLE VI

ACCESSIBLE EMISSION LIMITS FOR COLLATERAL  
RADIATION FROM LASER PRODUCTS

<p>1. <u>Accessible emission limits</u> for collateral radiation having wave-<sup>6</sup>lengths greater than 180 nanometers but less than or equal to <math>1.0 \times 10^6</math> nanometers are identical to the accessible emission limits of Class I laser radiation, as determined from Tables I and IV in this paragraph.</p> <p style="margin-left: 40px;">i. In the wavelength range of less than or equal to 400 nanometers, for all emission durations;</p> <p style="margin-left: 40px;">ii. In the wavelength range of greater than 400 nanometers, for all emission durations less than or equal to <math>1 \times 10^3</math> seconds and, when applicable under paragraph (f)(8) of this section, for all emission durations.</p> <p>2. <u>Accessible emission limit</u> for collateral radiation within the x-ray range of wavelengths is 0.5 milliroentgen in an hour, averaged over a cross-section parallel to the external surface of the product, having an area of 10 square centimeters with no dimension greater than 5 centimeters.</p>
-------------------------------------------------------------------------------------------------------------------------------------------------------------------------------------------------------------------------------------------------------------------------------------------------------------------------------------------------------------------------------------------------------------------------------------------------------------------------------------------------------------------------------------------------------------------------------------------------------------------------------------------------------------------------------------------------------------------------------------------------------------------------------------------------------------------------------------------------------------------------------------------------------------------------------------------------------------------------------------------------------------------------------------------------------------------

(1) *Beam of a single wavelength.* Laser or collateral radiation of a single wavelength exceeds the accessible emission limits of a class if its accessible emission level is greater than the accessible emission limit of that class within any of the ranges of emission duration specified in tables I, II-A, II, III-A, and III-B of this paragraph.

(2) *Beam of multiple wavelengths in same range.* Laser or collateral radiation having two or more wavelengths within any one of the wavelength ranges specified in tables I, II-A, II, III-A, and III-B of this paragraph exceeds the accessible emission limits of a class if the sum of the ratios of the accessible emission level to the cor-

responding accessible emission limit at each such wavelength is greater than unity for that combination of emission duration and wavelength distribution which results in the maximum sum.

(3) *Beam with multiple wavelengths in different ranges.* Laser or collateral radiation having wavelengths within two or more of the wavelength ranges specified in tables I, II-A, II, III-A, and III-B of this paragraph exceeds the accessible emission limits of a class if it exceeds the applicable limits within any one of those wavelength ranges. This determination is made for each wavelength range in accordance with paragraph (d) (1) or (2) of this section.

(4) *Class I dual limits.* Laser or collateral radiation in the wavelength range of greater than 400 nm but less than or equal to 1,400 nm exceeds the accessible emission limits of Class I if it exceeds both:

(i) The Class I accessible emission limits for radiant energy within any range of emission duration specified in table I of this paragraph, and

(ii) The Class I accessible emission limits for integrated radiance within any range of emission duration specified in table I of this paragraph.

(e) *Tests for determination of compliance—(1) Tests for certification.* Tests on which certification under §1010.2 is based shall account for all errors and statistical uncertainties in the measurement process. Because compliance with the standard is required for the useful life of a product such tests shall also account for increases in emission and degradation in radiation safety with age.

(2) *Test conditions.* Except as provided in §1010.13, tests for compliance with each of the applicable requirements of this section and §1040.11 shall be made during operation, maintenance, or service as appropriate:

(i) Under those conditions and procedures which maximize the accessible emission levels, including start-up, stabilized emission, and shut-down of the laser product; and

(ii) With all controls and adjustments listed in the operation, maintenance, and service instructions adjusted in combination to result in the maximum accessible emission level of radiation; and

(iii) At points in space to which human access is possible in the product configuration which is necessary to determine compliance with each requirement, e.g., if operation may require removal of portions of the protective housing and defeat of safety interlocks, measurements shall be made at points accessible in that product configuration; and

(iv) With the measuring instrument detector so positioned and so oriented with respect to the laser product as to result in the maximum detection of radiation by the instrument; and

(v) For a laser product other than a laser system, with the laser coupled to

that type of laser energy source which is specified as compatible by the laser product manufacturer and which produces the maximum emission level of accessible radiation from that product.

(3) *Measurement parameters.* Accessible emission levels of laser and collateral radiation shall be based upon the following measurements as appropriate, or their equivalent:

(i) For laser products intended to be used in a locale where the emitted laser radiation is unlikely to be viewed with optical instruments, the radiant power (W) or radiant energy (J) detectable through a circular aperture stop having a diameter of 7 millimeters and within a circular solid angle of acceptance of  $1 \times 10^{-3}$  steradian with collimating optics of 5 diopters or less. For scanned laser radiation, the direction of the solid angle of acceptance shall change as needed to maximize detectable radiation, with an angular speed of up to 5 radians/second. A 50 millimeter diameter aperture stop with the same collimating optics and acceptance angle stated above shall be used for all other laser products (except that a 7 millimeter diameter aperture stop shall be used in the measurement of scanned laser radiation emitted by laser products manufactured on or before August 20, 1986).

(ii) The irradiance ( $W\text{ cm}^{-2}$ ) or radiant exposure ( $J\text{ cm}^{-2}$  equivalent to the radiant power (W) or radiant energy (J) detectable through a circular aperture stop having a diameter of 7 millimeters and, for irradiance, within a circular solid angle of acceptance of  $1 \times 10^{-3}$  steradian with collimating optics of 5 diopters or less, divided by the area of the aperture stop ( $\text{cm}^{-2}$ ).

(iii) The radiance ( $W\text{ cm}^{-2}\text{ sr}^{-1}$ ) or integrated radiance ( $J\text{ cm}^{-2}\text{ sr}^{-1}$ ) equivalent to the radiant power (W) or radiant energy (J) detectable through a circular aperture stop having a diameter of 7 millimeters and within a circular solid angle of acceptance of  $1 \times 10^{-5}$  steradian with collimating optics of 5 diopters or less, divided by that solid angle (sr) and by the area of the aperture stop ( $\text{cm}^{-2}$ ).

(f) *Performance requirements—(1) Protective housing.* Each laser product shall have a protective housing that prevents human access during operation



to laser and collateral radiation that exceed the limits of Class I and table VI, respectively, wherever and whenever such human access is not necessary for the product to perform its intended function. Wherever and whenever human access to laser radiation levels that exceed the limits of Class I is necessary, these levels shall not exceed the limits of the lowest class necessary to perform the intended function(s) of the product.

(2) *Safety interlocks.* (i) Each laser product, regardless of its class, shall be provided with at least one safety interlock for each portion of the protective housing which is designed to be removed or displaced during operation or maintenance, if removal or displacement of the protective housing could permit, in the absence of such interlock(s), human access to laser or collateral radiation in excess of the accessible emission limit applicable under paragraph (f)(1) of this section.

(ii) Each required safety interlock, unless defeated, shall prevent such human access to laser and collateral radiation upon removal or displacement of such portion of the protective housing

(iii) Either multiple safety interlocks or a means to preclude removal or displacement of the interlocked portion of the protective housing shall be provided, if failure of a single interlock would allow;

(a) Human access to a level of laser radiation in excess of the accessible emission limits of Class IIIa; or

(b) Laser radiation in excess of the accessible emission limits of Class II to be emitted directly through the opening created by removal or displacement of the interlocked portion of the protective housing.

(iv) Laser products that incorporate safety interlocks designed to allow safety interlock defeat shall incorporate a means of visual or aural indication of interlock defeat. During interlock defeat, such indication shall be visible or audible whenever the laser product is energized, with and without the associated portion of the protective housing removed or displaced.

(v) Replacement of a removed or displaced portion of the protective hous-

ing shall not be possible while required safety interlocks are defeated.

(3) *Remote interlock connector.* Each laser system classified as a Class IIIb or IV laser product shall incorporate a readily available remote interlock connector having an electrical potential difference of no greater than 130 root-mean-square volts between terminals. When the terminals of the connector are not electrically joined, human access to all laser and collateral radiation from the laser product in excess of the accessible emission limits of Class I and table VI shall be prevented.

(4) *Key control.* Each laser system classified as a Class IIIb or IV laser product shall incorporate a key-actuated master control. The key shall be removable and the laser shall not be operable when the key is removed.

(5) *Laser radiation emission indicator.* (i) Each laser system classified as a Class II or IIIa laser product shall incorporate an emission indicator that provides a visible or audible signal during emission of accessible laser radiation in excess of the accessible emission limits of Class I.

(ii) Each laser system classified as a Class IIIb or IV laser product shall incorporate an emission indicator which provides a visible or audible signal during emission of accessible laser radiation in excess of the accessible emission limits of Class I, and sufficiently prior to emission of such radiation to allow appropriate action to avoid exposure to the laser radiation.

(iii) For laser systems manufactured on or before August 20, 1986, if the laser and laser energy source are housed separately and can be operated at a separation distance of greater than 2 meters, both laser and laser energy source shall incorporate an emission indicator as required in accordance with paragraph (f)(5) (i) or (ii) of this section. For laser systems manufactured after August 20, 1986, each separately housed laser and operation control of a laser system that regulates the laser or collateral radiation emitted by a product during operation shall incorporate an emission indicator as required in accordance with paragraph (f)(5) (i) or (ii) of this section, if the laser or operation control can be operated at a separation distance greater than 2 meters from

any other separately housed portion of the laser product incorporating an emission indicator.

(iv) Any visible signal required by paragraph (f)(5) (i) or (ii) of this section shall be clearly visible through protective eyewear designed specifically for the wavelength(s) of the emitted laser radiation.

(v) Emission indicators required by paragraph (f)(5) (i) or (ii) of this section shall be located so that viewing does not require human exposure to laser or collateral radiation in excess of the accessible emission limits of Class I and table VI.

(6) *Beam attenuator.* (i) Each laser system classified as a Class II, III, or IV laser product shall be provided with one or more permanently attached means, other than laser energy source switch(es), electrical supply main connectors, or the key-actuated master control, capable of preventing access by any part of the human body to all laser and collateral radiation in excess of the accessible emission limits of Class I and table VI.

(ii) If the configuration, design, or function of the laser product would make unnecessary compliance with the requirement in paragraph (f)(6)(i) of this section, the Director, Center for Devices and Radiological Health, may, upon written application by the manufacturer, approve alternate means to accomplish the radiation protection provided by the beam attenuator.

(7) *Location of controls.* Each Class IIa, II, III, or IV laser product shall have operational and adjustment controls located so that human exposure to laser or collateral radiation in excess of the accessible emission limits of Class I and table VI is unnecessary for operation or adjustment of such controls.

(8) *Viewing optics.* All viewing optics, viewports, and display screens incorporated into a laser product, regardless of its class, shall limit the levels of laser and collateral radiation accessible to the human eye by means of such viewing optics, viewports, or display screens during operation or maintenance to less than the accessible emission limits of Class I and table VI.

For any shutter or variable attenuator incorporated into such viewing optics, viewports, or display screens, a means shall be provided:

(i) To prevent access by the human eye to laser and collateral radiation in excess of the accessible emission limits of Class I and table VI whenever the shutter is opened or the attenuator varied.

(ii) To preclude, upon failure of such means as required in paragraph (f)(8)(i) of this section, opening the shutter or varying the attenuator when access by the human eye is possible to laser or collateral radiation in excess of the accessible emission limits of Class I and table VI.

(9) *Scanning safeguard.* Laser products that emit accessible scanned laser radiation shall not, as a result of any failure causing a change in either scan velocity or amplitude, permit human access to laser radiation in excess of:

(i) The accessible emission limits of the class of the product, or

(ii) The accessible emission limits of the class of the scanned laser radiation if the product is Class IIIb or IV and the accessible emission limits of Class IIIa would be exceeded solely as result of such failure.

(10) *Manual reset mechanism.* Each laser system manufactured after August 20, 1986, and classified as a Class IV laser product shall be provided with a manual reset to enable resumption of laser radiation emission after interruption of emission caused by the use of a remote interlock or after an interruption of emission in excess of 5 seconds duration due to the unexpected loss of main electrical power.

(g) *Labeling requirements.* In addition to the requirements of §§1010.2 and 1010.3, each laser product shall be subject to the applicable labeling requirements of this paragraph.

(1) *Class IIa and II designations and warnings.* (i) Each Class IIa laser product shall have affixed a label bearing the following wording: "Class IIa Laser Product—Avoid Long-Term Viewing of Direct Laser Radiation."

(ii) Each Class II laser product shall have affixed a label bearing the warning logotype A (figure 1 in this paragraph) and including the following wording:

[Position 1 on the logotype]  
 "LASER RADIATION—DO NOT STARE  
 INTO BEAM"; and  
 [Position 3 on the logotype]  
 "CLASS II LASER PRODUCT".

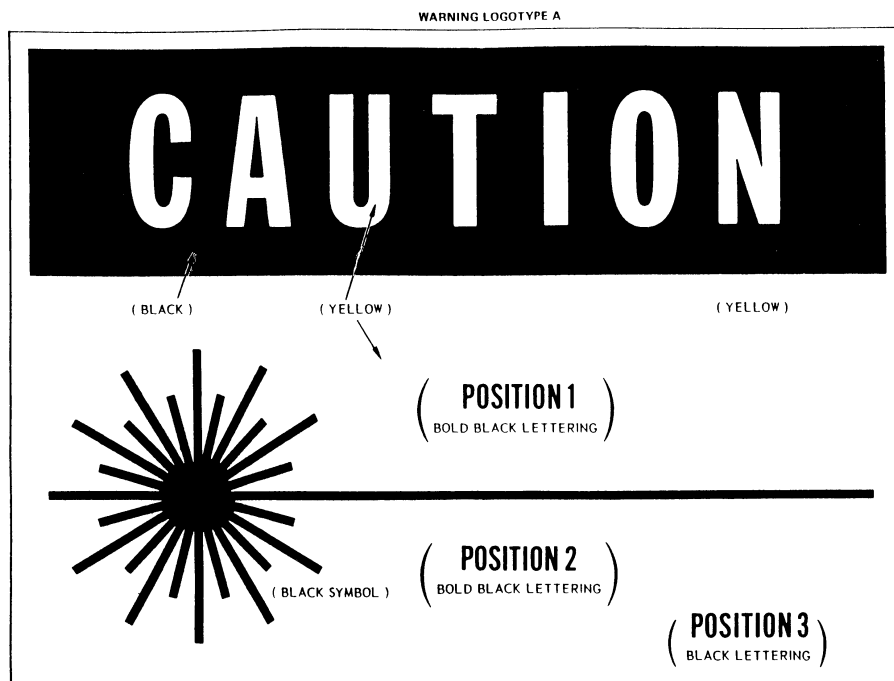

FIGURE 1

(2) *Class IIIa and IIIb designations and warnings.* (i) Each Class IIIa laser product with an irradiance less than or equal to  $2.5 \times 10^{-3} \text{ W cm}^{-2}$  shall have affixed a label bearing the warning logotype A (figure 1 of paragraph (g)(1)(ii) of this section) and including the following wording:

[Position 1 on the logotype]  
 "LASER RADIATION—DO NOT STARE  
 INTO BEAM OR VIEW DIRECTLY WITH  
 OPTICAL INSTRUMENTS"; and,

[Position 3 on the logotype]

"CLASS IIIa LASER PRODUCT".

(ii) Each Class IIIa laser product with an irradiance greater than  $2.5 \times 10^{-3} \text{ W}$

$\text{cm}^{-2}$  shall have affixed a label bearing the warning logotype B (figure 2 in this paragraph) and including the following wording:

[Position 1 on the logotype]  
 "LASER RADIATION—AVOID DIRECT EYE  
 EXPOSURE"; and,

[Position 3 on the logotype]

"CLASS IIIa LASER PRODUCT".

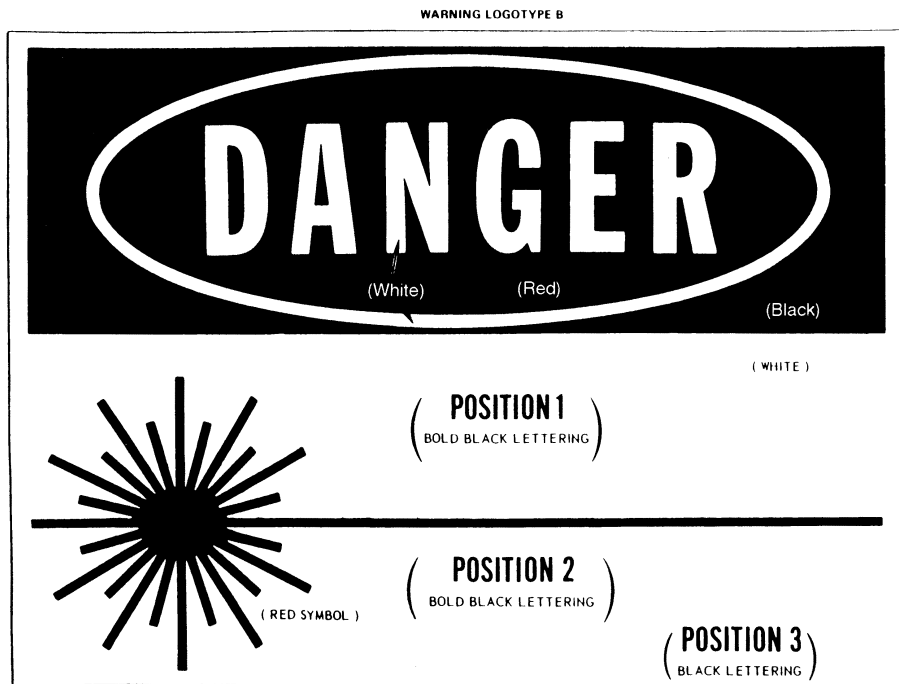

FIGURE 2

(iii) Each Class IIIb laser product shall have affixed a label bearing the warning logotype B (figure 2 of paragraph (g)(2)(ii) of this section) and including the following wording:

[Position 1 on the logotype]

“LASER RADIATION—AVOID DIRECT EXPOSURE TO BEAM”; and,

[Position 3 on the logotype]

“CLASS IIIb LASER PRODUCT”.

(3) *Class IV designation and warning.* Each Class IV laser product shall have affixed a label bearing the warning logotype B (figure 2 of paragraph (g)(2)(ii) of this section), and including the following wording:

[Position 1 on the logotype]

“LASER RADIATION—AVOID EYE OR SKIN EXPOSURE TO DIRECT OR SCATTERED RADIATION”; and,

[Position 3 on the logotype]

“CLASS IV LASER PRODUCT”.

(4) *Radiation output information on warning logotype.* Each Class II, III, and IV laser product shall state in appropriate units, at position 2 on the required warning logotype, the maximum output of laser radiation, the pulse duration when appropriate, and the laser medium or emitted wavelength(s).

(5) *Aperture label.* Each laser product, except medical laser products and Class IIa laser products, shall have affixed, in close proximity to each aperture through which is emitted accessible laser or collateral radiation in excess of the accessible emission limits of Class I and table VI of paragraph (d) of this section, a label(s) bearing the following wording as applicable.

(i) "AVOID EXPOSURE—Laser radiation is emitted from this aperture," if the radiation emitted through such aperture is laser radiation.

(ii) "AVOID EXPOSURE—Hazardous electromagnetic radiation is emitted from this aperture," if the radiation emitted through such aperture is collateral radiation described in table VI, item 1.

(iii) "AVOID EXPOSURE—Hazardous x-rays are emitted from this aperture," if the radiation emitted through such aperture is collateral radiation described in table VI, item 2.

(6) *Labels for noninterlocked protective housings.* For each laser product, labels shall be provided for each portion of the protective housing which has no safety interlock and which is designed to be displaced or removed during operation, maintenance, or service, and thereby could permit human access to laser or collateral radiation in excess of the limits of Class I and table VI. Such labels shall be visible on the protective housing prior to displacement or removal of such portion of the protective housing and visible on the product in close proximity to the opening created by removal or displacement of such portion of the protective housing, and shall include the wording:

(i) "CAUTION—Laser radiation when open. DO NOT STARE INTO BEAM." for Class II accessible laser radiation.

(ii) "CAUTION—Laser radiation when open. DO NOT STARE INTO BEAM OR VIEW DIRECTLY WITH OPTICAL INSTRUMENTS." for Class IIIa accessible laser radiation with an irradiance less than or equal to  $2.5 \times 10^{-3} \text{ W cm}^{-2}$ .

(iii) "DANGER—Laser radiation when open. AVOID DIRECT EYE EXPOSURE." for Class IIIa accessible laser radiation with an irradiance greater than  $2.5 \times 10^{-3} \text{ W cm}^{-2}$ .

(iv) "DANGER—Laser radiation when open. AVOID DIRECT EXPOSURE TO BEAM." for Class IIIb accessible laser radiation.

(v) "DANGER—Laser radiation when open. AVOID EYE OR SKIN EXPOSURE TO DIRECT OR SCATTERED RADIATION." for Class IV accessible laser radiation.

(vi) "CAUTION—Hazardous electromagnetic radiation when open." for

collateral radiation in excess of the accessible emission limits in table VI, item 1 of paragraph (d) of this section.

(vii) "CAUTION—Hazardous x-rays when open." for collateral radiation in excess of the accessible emission limits in table VI, item 2 of paragraph (d) of this section.

(7) *Labels for defeatably interlocked protective housings.* For each laser product, labels shall be provided for each defeatably interlocked (as described in paragraph (f)(2)(iv) of this section) portion of the protective housing which is designed to be displaced or removed during operation, maintenance, or service, and which upon interlock defeat could permit human access to laser or collateral radiation in excess of the limits of Class I or table VI. Such labels shall be visible on the product prior to and during interlock defeat and in close proximity to the opening created by the removal or displacement of such portion of the protective housing, and shall include the wording:

(i) "CAUTION—Laser radiation when open and interlock defeated. DO NOT STARE INTO BEAM." for Class II accessible laser radiation.

(ii) "CAUTION—Laser radiation when open and interlock defeated. DO NOT STARE INTO BEAM OR VIEW DIRECTLY WITH OPTICAL INSTRUMENTS." for Class IIIa accessible laser radiation with an irradiance less than or equal to  $2.5 \times 10^{-3} \text{ W cm}^{-2}$ .

(iii) "DANGER—Laser radiation when open and interlock defeated. AVOID DIRECT EYE EXPOSURE." for Class IIIa accessible laser radiation when an irradiance greater than  $2.5 \times 10^{-3} \text{ W cm}^{-2}$ .

(iv) "DANGER—Laser radiation when open and interlock defeated. AVOID DIRECT EXPOSURE TO BEAM." for Class IIIb accessible laser radiation.

(v) "DANGER—Laser radiation when open and interlock defeated. AVOID EYE OR SKIN EXPOSURE TO DIRECT OR SCATTERED RADIATION." for Class IV accessible laser radiation.

(vi) "CAUTION—Hazardous electromagnetic radiation when open and interlock defeated." for collateral radiation in excess of the accessible emission limits in table VI, item 1 of paragraph (d) of this section.

(vii) “CAUTION—Hazardous x-rays when open and interlock defeated.” for collateral radiation in excess of the accessible emission limits in table VI, item 2 of paragraph (d) of this section.

(8) *Warning for visible and/or invisible radiation.* On the labels specified in this paragraph, if the laser or collateral radiation referred to is:

(i) Invisible radiation, the word “invisible” shall appropriately precede the word “radiation”; or

(ii) Visible and invisible radiation, the words “visible and invisible” or “visible and/or invisible” shall appropriately precede the word “radiation.”

(iii) Visible laser radiation only, the phrase “laser light” may replace the phrase “laser radiation.”

(9) *Positioning of labels.* All labels affixed to a laser product shall be positioned so as to make unnecessary, during reading, human exposure to laser radiation in excess of the accessible emission limits of Class I radiation or the limits of collateral radiation established to table VI of paragraph (d) of this section.

(10) *Label specifications.* Labels required by this section and §1040.11 shall be permanently affixed to, or inscribed on, the laser product, legible, and clearly visible during operation, maintenance, or service, as appropriate. If the size, configuration, design, or function of the laser product would preclude compliance with the requirements for any required label or would render the required wording of such label inappropriate or ineffective, the Director, Center for Devices and Radiological Health, on the Director’s own initiative or upon written application by the manufacturer, may approve alternate means of providing such label(s) or alternate wording for such label(s) as applicable.

(h) *Informational requirements—(1) User information.* Manufacturers of laser products shall provide as an integral part of any user instruction or operation manual which is regularly supplied with the product, or, if not so supplied, shall cause to be provided with each laser product:

(i) Adequate instructions for assembly, operation, and maintenance, including clear warnings concerning precautions to avoid possible exposure to

laser and collateral radiation in excess of the accessible emission limits in tables I, II-A, II, III-A, III-B, and VI of paragraph (d) of this section, and a schedule of maintenance necessary to keep the product in compliance with this section and §1040.11.

(ii) A statement of the magnitude, in appropriate units, of the pulse durations(s), maximum radiant power and, where applicable, the maximum radiant energy per pulse of the accessible laser radiation detectable in each direction in excess of the accessible emission limits in table I of paragraph (d) of this section determined under paragraph (e) of this section.

(iii) Legible reproductions (color optional) of all labels and hazard warnings required by paragraph (g) of this section and §1040.11 to be affixed to the laser product or provided with the laser product, including the information required for positions 1, 2, and 3 of the applicable logotype (figure 1 of paragraph (g)(1)(ii) or figure 2 or paragraph (g)(2)(ii) of this section). The corresponding position of each label affixed to the product shall be indicated or, if provided with the product, a statement that such labels could not be affixed to the product but were supplied with the product and a statement of the form and manner in which they were supplied shall be provided.

(iv) A listing of all controls, adjustments, and procedures for operation and maintenance, including the warning “Caution—use of controls or adjustments or performance of procedures other than those specified herein may result in hazardous radiation exposure.”

(v) In the case of laser products other than laser systems, a statement of the compatibility requirements for a laser energy source that will assure compliance of the laser product with this section and §1040.11.

(vi) In the case of laser products classified with a 7 millimeter diameter aperture stop as provided in paragraph (e)(3)(i) of this section, if the use of a 50 millimeter diameter aperture stop would result in a higher classification of the product, the following warning

shall be included in the user information: "CAUTION—The use of optical instruments with this product will increase eye hazard."

(2) *Purchasing and servicing information.* Manufacturers of laser products shall provide or cause to be provided:

(i) In all catalogs, specification sheets, and descriptive brochures pertaining to each laser product, a legible reproduction (color optional) of the class designation and warning required by paragraph (g) of this section to be affixed to that product, including the information required for positions 1, 2, and 3 of the applicable logotype (figure 1 of paragraph (g)(1)(ii) or figure 2 of paragraph (g)(2)(ii) of this section).

(ii) To servicing dealers and distributors and to others upon request at a cost not to exceed the cost of preparation and distribution, adequate instructions for service adjustments and service procedures for each laser product model, including clear warnings and precautions to be taken to avoid possible exposure to laser and collateral radiation in excess of the accessible emission limits in tables I, II-A, II, III-A, III-B, and VI of paragraph (d) of this section, and a schedule of maintenance necessary to keep the product in compliance with this section and §1040.11; and in all such service instructions, a listing of those controls and procedures that could be utilized by persons other than the manufacturers or the manufacturer's agents to increase accessible emission levels of radiation and a clear description of the location of displaceable portions of the protective housing that could allow human access to laser or collateral radiation in excess of the accessible emission limits in tables I, II-A, II, III-A, III-B, and VI of paragraph (d) of this section. The instructions shall include protective procedures for service personnel to avoid exposure to levels of laser and collateral radiation known to be hazardous for each procedure or sequence of procedures to be accomplished, and legible reproductions (color optional) of required labels and hazard warnings.

(i) *Modification of a certified product.* The modification of a laser product, previously certified under §1010.2, by any person engaged in the business of

manufacturing, assembling, or modifying laser products shall be construed as manufacturing under the act if the modification affects any aspect of the product's performance or intended function(s) for which this section and §1040.11 have an applicable requirement. The manufacturer who performs such modification shall recertify and reidentify the product in accordance with the provisions of §§1010.2. and 1010.3.

(The information collection requirements contained in paragraph (a)(3)(ii) were approved by the Office of Management and Budget under control number 0910-0176)

[50 FR 33688, Aug. 20, 1985; 50 FR 42156, Oct. 18, 1985; 65 FR 17138, Mar. 31, 2000, as amended at 75 FR 20917, Apr. 22, 2010; 83 FR 13864, Apr. 2, 2018]

#### § 1040.11 Specific purpose laser products.

(a) *Medical laser products.* Each medical laser product shall comply with all of the applicable requirements of §1040.10 for laser products of its class. In addition, the manufacturer shall:

(1) Incorporate in each Class III or IV medical laser product a means for the measurement of the level of that laser radiation intended for irradiation of the human body. Such means may have an error in measurement of no more than 20 percent when calibrated in accordance with paragraph (a)(2) of this section. Indication of the measurement shall be in International System Units. The requirements of this paragraph do not apply to any laser radiation that is all of the following:

- (i) Of a level less than the accessible limits of Class IIIa; and
- (ii) Used for relative positioning of the human body; and
- (iii) Not used for irradiation of the human eye for ophthalmic purposes.

(2) Supply with each Class III or IV medical laser product instructions specifying a procedure and schedule for calibration of the measurement system required by paragraph (a)(1) of this section.

(3) Affix to each medical laser product, in close proximity to each aperture through which is emitted accessible laser radiation in excess of the accessible emission limits of Class I, a

## § 1040.20

## 21 CFR Ch. I (4–1–20 Edition)

label bearing the wording: “Laser aperture.”

(b) *Surveying, leveling, and alignment laser products.* Each surveying, leveling, or alignment laser product shall comply with all of the applicable requirements of § 1040.10 for a Class I, IIa, II or IIIa laser product and shall not permit human access to laser radiation in excess of the accessible emission limits of Class IIIa.

(c) *Demonstration laser products.* Each demonstration laser product shall comply with all of the applicable requirements of § 1040.10 for a Class I, IIa, II, or IIIa laser product and shall not permit human access to laser radiation in excess of the accessible emission limits of Class I and, if applicable, Class IIa, Class II, or Class IIIa.

[50 FR 33702, Aug. 20, 1985]

### § 1040.20 Sunlamp products and ultraviolet lamps intended for use in sunlamp products.

(a) *Applicability.* (1) The provisions of this section, as amended, are applicable as specified herein to the following products manufactured on or after September 8, 1986.

(i) Any sunlamp product.

(ii) Any ultraviolet lamp intended for use in any sunlamp product.

(2) Sunlamp products and ultraviolet lamps manufactured on or after May 7, 1980, but before September 8, 1986, are subject to the provisions of this section as published in the FEDERAL REGISTER of November 9, 1979 (44 FR 65357).

(b) *Definitions.* As used in this section the following definitions apply:

(1) *Exposure position* means any position, distance, orientation, or location relative to the radiating surfaces of the sunlamp product at which the user is intended to be exposed to ultraviolet radiation from the product, as recommended by the manufacturer.

(2) *Intended* means the same as “intended uses” in § 801.4.

(3) *Irradiance* means the radiant power incident on a surface at a specified location and orientation relative to the radiating surface divided by the area of the surface, as the area becomes vanishingly small, expressed in units of watts per square centimeter ( $W/cm^2$ ).

(4) *Maximum exposure time* means the greatest continuous exposure time interval recommended by the manufacturer of the product.

(5) *Maximum timer interval* means the greatest time interval setting on the timer of a product.

(6) *Protective eyewear* means any device designed to be worn by users of a product to reduce exposure of the eyes to radiation emitted by the product.

(7) *Spectral irradiance* means the irradiance resulting from radiation within a wavelength range divided by the wavelength range as the range becomes vanishingly small, expressed in units of watts per square centimeter per nanometer ( $W/(cm^2/nm)$ ).

(8) *Spectral transmittance* means the spectral irradiance transmitted through protective eyewear divided by the spectral irradiance incident on the protective eyewear.

(9) *Sunlamp product* means any electronic product designed to incorporate one or more ultraviolet lamps and intended for irradiation of any part of the living human body, by ultraviolet radiation with wavelengths in air between 200 and 400 nanometers, to induce skin tanning.

(10) *Timer* means any device incorporated into a product that terminates radiation emission after a preset time interval.

(11) *Ultraviolet lamp* means any lamp that produces ultraviolet radiation in the wavelength interval of 200 to 400 nanometers in air and that is intended for use in any sunlamp product.

(c) *Performance requirements*—(1) *Irradiance ratio limits.* For each sunlamp product and ultraviolet lamp, the ratio of the irradiance within the wavelength range of greater than 200 nanometers through 260 nanometers to the irradiance within the wavelength range of greater than 260 nanometers through 320 nanometers may not exceed 0.003 at any distance and direction from the product or lamp.

(2) *Timer system.* (i) Each sunlamp product shall incorporate a timer system with multiple timer settings adequate for the recommended exposure time intervals for different exposure positions and expected results of the products as specified in the label required by paragraph (d) of this section.



(ii) The maximum timer interval(s) may not exceed the manufacturer's recommended maximum exposure time(s) that is indicated on the label required by paragraph (d)(1)(iv) of this section.

(iii) No timer interval may have an error greater than 10 percent of the maximum timer interval of the product.

(iv) The timer may not automatically reset and cause radiation emission to resume for a period greater than the unused portion of the timer cycle, when emission from the sunlamp product has been terminated.

(v) The timer requirements do not preclude a product from allowing a user to reset the timer before the end of the preset time interval.

(3) *Control for termination of radiation emission.* Each sunlamp product shall incorporate a control on the product to enable the person being exposed to terminate manually radiation emission from the product at any time without disconnecting the electrical plug or removing the ultraviolet lamp.

(4) *Protective eyewear.* (i) Each sunlamp product shall be accompanied by the number of sets of protective eyewear that is equal to the maximum number of persons that the instructions provided under paragraph (e)(1)(ii) of this section recommend to be exposed simultaneously to radiation from such product.

(ii) The spectral transmittance to the eye of the protective eyewear required by paragraph (c)(4)(i) of this section shall not exceed a value of 0.001 over the wavelength range of greater than 200 nanometers 320 nanometers and a value of 0.01 over the wavelength range of greater than 320 nanometers through 400 nanometers, and shall be sufficient over the wavelength greater than 400 nanometers to enable the user to see clearly enough to reset the timer.

(5) *Compatibility of lamps.* An ultraviolet lamp may not be capable of insertion and operation in either the "single-contact medium screw" or the "double-contact medium screw" lampholders described in American National Standard C81.10-1976, Specifications for Electric Lamp Bases and Holders—Screw-Shell Types, which is incorporated by reference. Copies are

available from the American National Standards Institute, 1430 Broadway, New York, NY 10018, or available for inspection at the National Archives and Records Administration (NARA). For information on the availability of this material at NARA, call 202-741-6030, or go to: [http://www.archives.gov/federal\\_register/code\\_of\\_federal\\_regulations/ibr\\_locations.html](http://www.archives.gov/federal_register/code_of_federal_regulations/ibr_locations.html).

(d) *Label requirements.* In addition to the labeling requirements in part 801 and the certification and identification requirements of §§1010.2 and 1010.3, each sunlamp product and ultraviolet lamp shall be subject to the labeling requirements prescribed in this paragraph and paragraph (e) of this section.

(1) *Labels for sunlamp products.* Each sunlamp product shall have a label(s) which contains:

(i) A warning statement with the words "DANGER—Ultraviolet radiation. Follow instructions. Avoid overexposure. As with natural sunlight, overexposure can cause eye and skin injury and allergic reactions. Repeated exposure may cause premature aging of the skin and skin cancer. WEAR PROTECTIVE EYEWEAR; FAILURE TO MAY RESULT IN SEVERE BURNS OR LONG-TERM INJURY TO THE EYES. Medications or cosmetics may increase your sensitivity to the ultraviolet radiation. Consult physician before using sunlamp if you are using medications or have a history of skin problems or believe yourself especially sensitive to sunlight. If you do not tan in the sun, you are unlikely to tan from the use of this product."

(ii) Recommended exposure position(s). Any exposure position may be expressed either in terms of a distance specified both in meters and in feet (or in inches) or through the use of markings or other means to indicate clearly the recommended exposure position.

(iii) Directions for achieving the recommended exposure position(s) and a warning that the use of other positions may result in overexposure.

(iv) A recommended exposure schedule including duration and spacing of sequential exposures and maximum exposure time(s) in minutes.

(v) A statement of the time it may take before the expected results appear.

(vi) Designation of the ultraviolet lamp type to be used in the product.

(2) *Labels for ultraviolet lamps.* Each ultraviolet lamp shall have a label which contains:

(i) The words “Sunlamp—DANGER—Ultraviolet radiation. Follow instructions.”

(ii) The model identification.

(iii) The words “Use ONLY in fixture equipped with a timer.”

(3) *Label specifications.* (i) Any label prescribed in this paragraph for sunlamp products shall be permanently affixed or inscribed on an exterior surface of the product when fully assembled for use so as to be legible and readily accessible to view by the person being exposed immediately before the use of the product.

(ii) Any label prescribed in this paragraph for ultraviolet lamps shall be permanently affixed or inscribed on the product so as to be legible and readily accessible to view.

(iii) If the size, configuration, design, or function of the sunlamp product or ultraviolet lamp would preclude compliance with the requirements for any required label or would render the required wording of such label inappropriate or ineffective, or would render the required label unnecessary, the Director, Center for Devices and Radiological Health, on the center’s own initiative or upon written application by the manufacturer, may approve alternate means of providing such label(s), alternate wording for such label(s), or deletion, as applicable.

(iv) In lieu of permanently affixing or inscribing tags or labels on the ultraviolet lamp as required by §§1010.2(b) and 1010.3(a), the manufacturer of the ultraviolet lamp may permanently affix or inscribe such required tags or labels on the lamp packaging uniquely associated with the lamp, if the name of the manufacturer and month and year of manufacture are permanently affixed or inscribed on the exterior surface of the ultraviolet lamp so as to be legible and readily accessible to view. The name of the manufacturer and month and year of manufacture affixed or inscribed on the exterior surface of

the lamp may be expressed in code or symbols, if the manufacturer has previously supplied the Director, Center for Devices and Radiological Health, with the key to such code or symbols and the location of the coded information or symbols on the ultraviolet lamp. The label or tag affixed or inscribed on the lamp packaging may provide either the month and year of manufacture without abbreviation, or information to allow the date to be readily decoded.

(v) A label may contain statements or illustrations in addition to those required by this paragraph if the additional statements are not false or misleading in any particular; e.g., if they do not diminish the impact of the required statements; and are not prohibited by this chapter.

(e) *Instructions to be provided to users.* Each manufacturer of a sunlamp product and ultraviolet lamp shall provide or cause to be provided to purchasers and, upon request, to others at a cost not to exceed the cost of publication and distribution, adequate instructions for use to avoid or to minimize potential injury to the user, including the following technical and safety information as applicable:

(1) *Sunlamp products.* The users’ instructions for a sunlamp product shall contain:

(i) A reproduction of the label(s) required in paragraph (d)(1) of this section prominently displayed at the beginning of the instructions.

(ii) A statement of the maximum number of people who may be exposed to the product at the same time and a warning that only that number of protective eyewear has been provided.

(iii) Instructions for the proper operation of the product including the function, use, and setting of the timer and other controls, and the use of protective eyewear.

(iv) Instructions for determining the correct exposure time and schedule for persons according to skin type.

(v) Instructions for obtaining repairs and recommended replacement components and accessories which are compatible with the product, including compatible protective eyewear, ultraviolet lamps, timers, reflectors, and filters, and which will, if installed or used

as instructed, result in continued compliance with the standard.

(2) *Ultraviolet lamps.* The users' instructions for an ultraviolet lamp not accompanying a sunlamp product shall contain:

(i) A reproduction of the label(s) required in paragraphs (d)(1)(i) and (2) of this section, prominently displayed at the beginning of the instructions.

(ii) A warning that the instructions accompanying the sunlamp product should always be followed to avoid or to minimize potential injury.

(iii) A clear identification by brand and model designation of all lamp models for which replacement lamps are promoted, if applicable.

(f) *Test for determination of compliance.* Tests on which certification pursuant to §1010.2 is based shall account for all errors and statistical uncertainties in the process and, wherever applicable, for changes in radiation emission or degradation in radiation safety with age of the product. Measurements for certification purposes shall be made under those operational conditions, lamp voltage, current, and position as recommended by the manufacturer. For these measurements, the measuring instrument shall be positioned at the recommended exposure position and so oriented as to result in the maximum detection of the radiation by the instrument.

[50 FR 36550, Sept. 6, 1985, as amended at 67 FR 9587, Mar. 4, 2002; 69 FR 18803, Apr. 9, 2004; 75 FR 20917, Apr. 22, 2010; 83 FR 13865, Apr. 2, 2018]

**§ 1040.30 High-intensity mercury vapor discharge lamps.**

(a) *Applicability.* The provisions of this section apply to any high-intensity mercury vapor discharge lamp that is designed, intended, or promoted for illumination purposes and is manufactured or assembled after March 7, 1980, except as described in paragraph (d)(1)(ii) of this section.

(b) *Definitions.* (1) *High-intensity mercury vapor discharge lamp* means any lamp including any "mercury vapor" and "metal halide" lamp, with the exception of the tungsten filament self-ballasted mercury vapor lamp, incorporating a high-pressure arc discharge tube that has a fill consisting pri-

marily of mercury and that is contained within an outer envelope.

(2) *Advertisement* means any catalog, specification sheet, price list, and any other descriptive or commercial brochure and literature, including videotape and film, pertaining to high-intensity mercury vapor discharge lamps.

(3) *Packaging* means any lamp carton, outer wrapping, or other means of containment that is intended for the storage, shipment, or display of a high-intensity mercury vapor lamp and is intended to identify the contents or recommend its use.

(4) *Outer envelope* means the lamp element, usually glass, surrounding a high-pressure arc discharge tube, that, when intact, attenuates the emission of shortwave ultraviolet radiation.

(5) *Shortwave ultraviolet radiation* means ultraviolet radiation with wavelengths shorter than 320 nanometers.

(6) *Cumulative operating time* means the sum of the times during which electric current passes through the high-pressure arc discharge.

(7) *Self-extinguishing lamp* means a high-intensity mercury vapor discharge lamp that is intended to comply with the requirements of paragraph (d)(1) of this section as applicable.

(8) *Reference ballast* is an inductive reactor designed to have the operating characteristics as listed in Section 7 in the American National Standard Specifications for High-Intensity Discharge Lamp Reference Ballasts (ANSI C82.5-1977)<sup>1</sup> or its equivalent.

(c) *General requirements for all lamps.*

(1) Each high-intensity mercury vapor discharge lamp shall:

(i) Meet the requirements of either paragraph (d) or paragraph (e) of this section; and

(ii) Be permanently labeled or marked in such a manner that the name of the manufacturer and the month and year of manufacture of the lamp can be determined on an intact lamp and after the outer envelope of the lamp is broken or removed. The name of the manufacturer and month and year of manufacture may be expressed in code or symbols, provided

<sup>1</sup>Copies are available from American National Standards Institute, 1430 Broadway, New York, NY 10018.

the manufacturer has previously supplied the Director, Center for Devices and Radiological Health, with the key to the code or symbols and the location of the coded information or symbols on the lamp.

(2) In lieu of permanently affixing or inscribing tags or labels on the product as required by §§ 1010.2(b) and 1010.3(a) of this chapter, the manufacturer of any high-intensity mercury vapor discharge lamp may permanently affix or inscribe such required tags or labels on the lamp packaging uniquely associated with the applicable lamp.

(d) *Requirements for self-extinguishing lamps*—(1) *Maximum cumulative operating time.* (i) Each self-extinguishing lamp manufactured after March 7, 1980 shall cease operation within a cumulative operating time not to exceed 15 minutes following complete breakage or removal of the outer envelope (with the exception of fragments extending 50 millimeters or less from the base shell); and

(ii) Each self-extinguishing lamp manufactured after September 7, 1981, shall cease operation within a cumulative operating time not to exceed 15 minutes following breakage or removal of at least 3 square centimeters of contiguous surface of the outer envelope.

(2) *Lamp labeling.* Each self-extinguishing lamp shall be clearly marked with the letter “T” on the outer envelope and on another part of the lamp in such a manner that it is visible after the outer envelope of the lamp is broken or removed.

(3) *Lamp packaging.* Lamp packaging for each self-extinguishing lamp shall clearly and prominently display:

(i) The letter “T”; and

(ii) The words “This lamp should self-extinguish within 15 minutes after the outer envelope is broken or punctured. If such damage occurs, TURN OFF AND REMOVE LAMP to avoid possible injury from hazardous shortwave ultraviolet radiation.”

(e) *Requirements for lamps that are not self-extinguishing lamps*—(1) *Lamp labeling.* Any high-intensity mercury vapor discharge lamp that does not comply with paragraph (d)(1) of this section shall be clearly and legibly marked with the letter “R” on the outer envelope and on another part of the lamp in

such a manner that it is visible after the outer envelope of the lamp is broken or removed.

(2) *Lamp packaging.* Lamp packaging for each high-intensity mercury vapor discharge lamp that does not comply with paragraph (d)(1) of this section shall clearly and prominently display:

(i) The letter “R”; and

(ii) The words “WARNING: This lamp can cause serious skin burn and eye inflammation from shortwave ultraviolet radiation if outer envelope of the lamp is broken or punctured. Do not use where people will remain for more than a few minutes unless adequate shielding or other safety precautions are used. Lamps that will automatically extinguish when the outer envelope is broken or punctured are commercially available.”

(3) *Lamp advertisement.* Advertising for any high-intensity mercury vapor discharge lamp that does not comply with paragraph (d)(1) of this section shall prominently display the following wording: “WARNING: This lamp can cause serious skin burn and eye inflammation from shortwave ultraviolet radiation if outer envelope of the lamp is broken or punctured. Do not use where people will remain for more than a few minutes unless adequate shielding or other safety precautions are used. Lamps that will automatically extinguish when the outer envelope is broken or punctured are commercially available.”

(f) *Test conditions.* Any high-intensity mercury vapor discharge lamp under test for compliance with the requirements set forth in paragraph (d)(1) of this section shall be started and operated under the following conditions as applicable:

(1) Lamp voltage, current, and orientation shall be those indicated or recommended by the manufacturer for operation of the intact lamp.

(2) The lamp shall be operated on a reference ballast.

(3) The lamp shall be started in air that has a temperature of  $25 \pm 5$  °C. Heating and movement of the air surrounding the lamp shall be that produced by the lamp and ballast alone.

(4) If any test is performed in an enclosure, the enclosure shall be not less than 0.227 cubic meter (8 cubic feet).

(5) Any lamp designed to be operated only in a specific fixture or luminaire that the lamp manufacturer supplies or specifies shall be tested in that fixture or luminaire. Any other lamp shall be tested with no reflector or other surrounding material.

[44 FR 52195, Sept. 7, 1979, as amended at 53 FR 11254, Apr. 6, 1988]

## PART 1050—PERFORMANCE STANDARDS FOR SONIC, INFRASONIC, AND ULTRASONIC RADIATION-EMITTING PRODUCTS

AUTHORITY: 21 U.S.C. 351, 352, 360, 360e-360j, 360hh-360ss, 371, 381.

### § 1050.10 Ultrasonic therapy products.

(a) *Applicability.* The provisions of this section are applicable as specified herein to any ultrasonic therapy product for use in physical therapy manufactured on or after February 17, 1979.

(b) *Definitions.* The following definitions apply to words and phrases used in this section:

(1) *Amplitude modulated waveform* means a waveform in which the ratio of the temporal-maximum pressure amplitude spatially averaged over the effective radiating surface to the root-mean-square pressure amplitude spatially averaged over the effective radiating surface is greater than 1.05.

(2) *Applicator* means that portion of a fully assembled ultrasonic therapy product that is designed to emit ultrasonic radiation and which includes one or more ultrasonic transducers and any associated housing.

(3) *Beam cross-section* means the surface in any plane consisting of the points at which the intensity is greater than 5 percent of the spatial-maximum intensity in that plane.

(4) *Beam nonuniformity ratio* means the ratio of the temporal-average spatial-maximum intensity to the temporal-average effective intensity.

(5) *Centroid of a surface* means the point whose coordinates are the mean values of the coordinates of the points of the surface.

(6) *Collimating applicator* means an applicator that does not meet the definition of a focusing applicator as specified in paragraph (b)(15) of this section

and for which the ratio of the area of at least one beam cross-section, whose centroid is 12 centimeters from the centroid of the effective radiating surface, to the area of the effective radiating surface is less than two.

(7) *Continuous-wave waveform* means a waveform in which the ratio of the temporal-maximum pressure amplitude spatially averaged over the effective radiating surface to the root-mean-square pressure amplitude spatially averaged over the effective radiating surface is less than or equal to 1.05.

(8) *Diverging applicator* means an applicator that does not meet the definition of a collimating applicator or a focusing applicator as specified in paragraphs (b) (6) and (15) of this section.

(9) *Effective intensity* means the ratio of the ultrasonic power to the focal area for a focusing applicator. For all other applicators, the effective intensity is the ratio of the ultrasonic power to the effective radiating area. Effective intensity is expressed in watts per square centimeter ( $W\text{ cm}^{-2}$ ).

(10) *Effective radiating area* means the area consisting of all points of the effective radiating surface at which the intensity is 5 percent or more of the maximum intensity at the effective radiating surface, expressed in square centimeters ( $\text{cm}^2$ ).

(11) *Effective radiating surface* means the surface consisting of all points 5 millimeters from the applicator face.

(12) *Focal area* means the area of the focal surface, expressed in square centimeters ( $\text{cm}^2$ ).

(13) *Focal length* means the distance between the centroids of the effective radiating surface and the focal surface, for a focusing applicator, expressed in centimeters (cm).

(14) *Focal surface* means the beam cross-section with smallest area of a focusing applicator.

(15) *Focusing applicator* means an applicator in which the ratio of the area of the beam cross-section with the smallest area to the effective radiating area is less than one-half.

(16) *Generator* means that portion of a fully assembled ultrasonic therapy product that supplies electrical energy to the applicator. The generator may include, but is not limited to, a power supply, ultrasonic frequency oscillator,

§ 1050.10

21 CFR Ch. I (4-1-20 Edition)

service controls, operation controls, and a cabinet to house these components.

(17) *Maximum beam nonuniformity ratio* means the maximum value of the beam nonuniformity ratio characteristic of a model of an ultrasonic therapy product.

(18) *Operation control* means any control used during operation of an ultrasonic therapy product that affects the ultrasonic radiation emitted by the applicator.

(19) *Pressure amplitude* means the instantaneous value of the modulating waveform, and is  $p_1(t)$  in the expression for a pressure wave,  $p(t) = p_1(t) p_2(t)$ , where  $p(t)$  is the instantaneous pressure,  $p_1(t)$  is the modulating envelope, and  $p_2(t)$  is the relative amplitude of the carrier wave normalized to a peak height of one. All are periodic functions of time,  $t$ , at any point in space. The period of  $p_1(t)$  is greater than the period of  $p_2(t)$ .

(20) *Pulse duration* means a time interval, expressed in seconds, beginning at the first time the pressure amplitude exceeds the minimum pressure amplitude plus 10 percent of the difference between the maximum and minimum pressure amplitudes, and ending at the last time the pressure amplitude returns to this value.

(21) *Pulse repetition rate* means the repetition frequency of the waveform modulating the ultrasonic carrier wave expressed in pulses per second (pps).

(22) *Service control* means any control provided for the purpose of adjustment that is not used during operation and can affect the ultrasonic radiation emitted by the applicator, or can alter the calibration or accuracy of an indicator or operation control.

(23) *Ultrasonic frequency* means the frequency of the ultrasonic radiation carrier wave, expressed in Hertz (Hz), kilohertz (kHz), or megahertz (MHz).

(24) *Ultrasonic power* means the total power emitted in the form of ultrasonic radiation by the applicator averaged over each cycle of the ultrasonic radiation carrier wave, expressed in watts.

(25) *Ultrasonic therapy product* means:

(i) Any device intended to generate and emit ultrasonic radiation for therapeutic purposes at ultrasonic frequencies above 16 kilohertz (kHz); or

(ii) Any generator or applicator designed or specifically designated for use in a device as specified in paragraph (b)(25)(i) of this section.

(26) *Ultrasonic transducer* means a device used to convert electrical energy of ultrasonic frequency into ultrasonic radiation or vice versa.

(c) *Performance requirements.* The requirements of this paragraph are applicable to each ultrasonic therapy product as defined in paragraph (b)(25) of this section when the generator and applicator are designated or intended for use together, or to each generator when the applicator(s) intended for use with the generator does not contain controls that affect the functioning of the generator.

(1) *Ultrasonic power and intensity—(i) Continuous-wave waveform operation.* A means shall be incorporated to indicate the magnitudes of the temporal-average ultrasonic power and the temporal-average effective intensity when emission is of continuous-wave waveform. The error in the indication of the temporal-average ultrasonic power shall not exceed  $\pm 20$  percent for all emissions greater than 10 percent of the maximum emission.

(ii) *Amplitude-modulated waveform operation.* A means shall be incorporated to indicate the magnitudes of the temporal-maximum ultrasonic power and the temporal-maximum effective intensity when the emission is of amplitude-modulated waveform. The sum of the errors in the indications of the temporal-maximum ultrasonic power and the ratio of the temporal-maximum effective intensity to the temporal-average effective intensity specified in paragraph (d)(3)(ii) of this section shall not exceed  $\pm 20$  percent for all emissions greater than 10 percent of the maximum emission.

(2) *Treatment time.* A means shall be incorporated to enable the duration of emission of ultrasonic radiation for treatment to be preset and such means shall terminate emission at the end of the preset time. Means shall also be incorporated to enable termination of emission at any time. Means shall be incorporated to indicate the magnitude of the duration of emission (expressed in minutes) to within 0.5 minute of the preset duration of emission for setting

less than 5 minutes, to within 10 percent of the preset duration of emission for settings of from 5 minutes to 10 minutes, and to within 1 minute of the preset duration of emission for settings greater than 10 minutes.

(3) *Pulse duration and repetition rate.* A means shall be incorporated for indicating the magnitudes of pulse duration and pulse repetition rate of the emitted ultrasonic radiation, if there are operation controls for varying these quantities.

(4) *Ultrasonic frequency.* A means shall be incorporated for indicating the magnitude of the ultrasonic frequency of the emitted ultrasonic radiation, if there is an operation control for varying this quantity.

(5) *Visual indicator.* A means shall be incorporated to provide a clear, distinct, and readily understood visual indicator when and only when electrical energy of appropriate ultrasonic frequency is being applied to the ultrasonic transducer(s).

(d) *Labeling requirements.* In addition to the labeling requirements in part 801 and the requirements of §§1010.2 and 1010.3 of this chapter, each ultrasonic therapy product shall be subject to the applicable labeling requirements of this paragraph.

(1) *Operation controls.* Each operation control shall be clearly labeled identifying the function controlled and, where appropriate, the units of measure of that function. If a separate control and indicator are associated with the same function, then labeling the appropriate units of measure of that function is required for the indicator but not for the control.

(2) *Service controls.* Each service control that is accessible without displacement or removal of any part of the ultrasonic therapy product shall be clearly labeled identifying the function controlled and shall include the phrase "for service adjustment only."

(3) *Generators.* (i) Each generator shall bear a label that states: The brand name, model designation, and unique serial number or other unique identification so that it is individually identifiable; ultrasonic frequency (unless there is an operation control for varying this quantity); and type of

waveform (continuous wave or amplitude modulated).

(ii) Generators employing amplitude-modulated waveforms shall also bear a label that provides the following information: Pulse duration and pulse repetition rate (unless there are operation controls for varying these quantities), an illustration of the amplitude-modulated waveform, and the ratio of the temporal-maximum effective intensity to the temporal-average effective intensity. (If this ratio is a function of any operation control setting, then the range of the ratio shall be specified, and the waveform illustration shall be provided for the maximum value of this ratio.)

(4) *Applicators.* Each applicator shall bear a label that provides the following information:

(i) The brand name, model designation, and unique serial number or other unique identification so the applicator is individually identifiable;

(ii) A designation of the generator(s) for which the applicator is intended; and

(iii) The ultrasonic frequency, effective radiating area, maximum beam nonuniformity ratio, type of applicator (focusing, collimating, diverging), and for a focusing applicator the focal length and focal area.

(5) *Label specification.* Labels required by this paragraph shall be permanently affixed to or inscribed on the ultrasonic therapy product; they shall be legible and clearly visible. If the size, configuration, or design of the ultrasonic therapy product would preclude compliance with the requirements of this paragraph, the Director, Center for Devices and Radiological Health, may approve alternate means of providing such labels).

(e) *Tests for determination of compliance—(1) Tests for certification.* Tests on which certification pursuant to §1010.2 of this chapter is based shall account for all measurement errors and uncertainties. Such tests shall also account for increases in emission and degradation in radiation safety that occur with age.

(2) *Test conditions.* Except as provided in §1010.13 of this chapter, tests for compliance with each of the applicable

§ 1050.10

21 CFR Ch. I (4-1-20 Edition)

requirements of this section shall be made:

(i) For all possible combinations of adjustments of the controls listed in the operation instructions.

(ii) With the ultrasonic radiation emitted into the equivalent of an infinite medium of distilled, degassed water at 30 °C for measurements concerning the ultrasonic radiation.

(iii) With line voltage variations in the range of ±10 percent of the rated value specified by the manufacturer.

(3) *Measurement parameters.* Measurements for determination of the spatial distribution of the ultrasonic radiation field shall be made with a detector having dimensions of less than one wavelength in water or an equivalent measurement technique.

(f) *Informational requirements—(1) Servicing information.* The manufacturer of an ultrasonic therapy product shall provide or cause to be provided to servicing dealers and distributors, and to others upon request, at a cost not to exceed the cost of preparation and distribution adequate instructions for operations, service, and calibration, including a description of those controls and procedures that could be used to increase radiation emission levels, and a schedule of maintenance necessary to keep equipment in compliance with this section. The instructions shall include adequate safety precautions that may be necessary regarding ultrasonic radiation exposure.

(2) *User information.* The manufacturer of an ultrasonic therapy product shall provide as an integral part of any user instruction or operation manual that is regularly supplied with the product, or, if not so supplied, shall cause to be provided with each ultrasonic therapy product, and to others upon request, at a cost not to exceed the cost of preparation and distribution:

(i) Adequate instructions concerning assembly, operation, safe use, any safety procedures and precautions that may be necessary regarding the use of

ultrasonic radiation, and a schedule of maintenance necessary to keep the equipment in compliance with this section. The operation instructions shall include a discussion of all operation controls, and shall describe the effect of each control.

(ii) Adequate description of the spatial distribution of the ultrasonic radiation field and the orientation of the field with respect to the applicator. This will include a textual discussion with diagrams, plots, or photographs representative of the beam pattern. If there is more than one ultrasonic transducer in an applicator and their positions are not fixed relative of each other, then the description must specify the spatial distribution of the ultrasonic radiation field emitted by each ultrasonic transducer and present adequate examples of the combination field of the ultrasonic transducers with regard to safe use. The description of the ultrasonic radiation field shall state that such description applies under conditions specified in paragraph (e)(2)(ii) of this section.

(iii) Adequate description, as appropriate to the product, of the uncertainties in magnitude expressed in terms of percentage error, of the ultrasonic frequency effective radiating area, and, where applicable, the ratio of the temporal-maximum effective intensity to the temporal-average effective intensity, pulse duration, pulse repetition rate, focal area, and focal length. The errors in indications specified in paragraphs (c)(1) and (c)(2) of this section shall be stated in the instruction manual.

(iv) A listing of controls, adjustments, and procedures for operation and maintenance, including the warning “Caution—use of controls or adjustments or performance of procedures other than those specified herein may result in hazardous exposure to ultrasonic energy.”

[43 FR 7166, Feb. 17, 1978, as amended at 45 FR 16483, Mar. 14, 1980; 53 FR 11255, Apr. 6, 1988]



## SUBCHAPTER K—TOBACCO PRODUCTS

### PART 1100—TOBACCO PRODUCTS SUBJECT TO FDA AUTHORITY

Sec.

1100.1 Scope.

1100.2 Requirements.

1100.3 Definitions.

1100.5 Exclusion from tobacco regulation.

AUTHORITY: 21 U.S.C. 387a(b), 387f(d); Secs. 901(b) and 906(d), Pub. L. 111-31; 21 CFR 16.1 and 1107.1; 21 CFR 1.1, 1.20, 14.55, 17.1, and 17.2. Section 1100.5 is issued under 21 U.S.C. 321, 353(g), and 371(a); 21 CFR 1.1.

SOURCE: 81 FR 29102, May 10, 2016, unless otherwise noted.

#### § 1100.1 Scope.

In addition to FDA's authority over cigarettes, cigarette tobacco, roll-your-own tobacco, and smokeless tobacco, FDA deems all other products meeting the definition of *tobacco product* under section 201(rr) of the Federal Food, Drug, and Cosmetic Act, except accessories of such other tobacco products, to be subject to the Federal Food, Drug, and Cosmetic Act.

#### § 1100.2 Requirements.

Cigarettes, cigarette tobacco, roll-your-own tobacco, smokeless tobacco are subject to chapter IX of the Federal Food, Drug, and Cosmetic Act and its implementing regulations. FDA has deemed all other tobacco products, except accessories of such other tobacco products, subject to chapter IX of the Federal Food, Drug, and Cosmetic Act and its implementing regulations.

#### § 1100.3 Definitions.

For the purposes of this part:

*Accessory* means any product that is intended or reasonably expected to be used with or for the human consumption of a tobacco product; does not contain tobacco and is not made or derived from tobacco; and meets either of the following:

(1) Is not intended or reasonably expected to affect or alter the performance, composition, constituents, or characteristics of a tobacco product; or

(2) Is intended or reasonably expected to affect or maintain the performance,

composition, constituents, or characteristics of a tobacco product but

(i) Solely controls moisture and/or temperature of a stored tobacco product; or

(ii) Solely provides an external heat source to initiate but not maintain combustion of a tobacco product.

*Component* or *part* means any software or assembly of materials intended or reasonably expected:

(1) To alter or affect the tobacco product's performance, composition, constituents, or characteristics; or

(2) To be used with or for the human consumption of a tobacco product. Component or part excludes anything that is an accessory of a tobacco product.

*Package* or *packaging* means a pack, box, carton, or container of any kind or, if no other container, any wrapping (including cellophane), in which a tobacco product is offered for sale, sold, or otherwise distributed to consumers.

*Tobacco product*. As stated in section 201(rr) of the Federal Food, Drug, and Cosmetic Act in relevant part, a tobacco product:

(1) Means any product made or derived from tobacco that is intended for human consumption, including any component, part, or accessory of a tobacco product (except for raw materials other than tobacco used in manufacturing a component, part, or accessory of a tobacco product); and

(2) Does not mean an article that is a drug under section 201(g)(1) of the Federal Food, Drug, and Cosmetic Act, a device under section 201(h) of the Federal Food, Drug, and Cosmetic Act, or a combination product described in section 503(g) of the Federal Food, Drug, and Cosmetic Act.

#### § 1100.5 Exclusion from tobacco regulation.

If a product made or derived from tobacco that is intended for human consumption is intended for use for any of the purposes described in paragraph (a) or (b) of this section, the product is not a tobacco product as defined in section 201(rr) of the Federal Food, Drug, and Cosmetic Act and will be subject to

regulation as a drug, device, or combination product.

(a) The product is intended for use in the diagnosis of disease or other conditions, or in the cure, mitigation, treatment or prevention of disease, including use in the cure or treatment of nicotine addiction (*e.g.*, smoking cessation), relapse prevention, or relief of nicotine withdrawal symptoms;

(b) The product is intended to affect the structure or any function of the body in any way that is different from effects related to nicotine that were commonly and legally claimed in the marketing of cigarettes and smokeless tobacco products prior to March 21, 2000.

[82 FR 2217, Jan. 9, 2017]

## PART 1105—GENERAL

AUTHORITY: 21 U.S.C. 371(a), 387e, 387j, and 387k.

SOURCE: 81 FR 95869, Dec. 29, 2016, unless otherwise noted.

### Subpart A—General Submission Requirements

#### §1105.10 Refusal to accept a pre-market submission.

(a) FDA will refuse to accept for review, as soon as practicable, a pre-market tobacco product application, modified risk tobacco product application, substantial equivalence application, or exemption request or subsequent abbreviated report for the following reasons, if applicable:

(1) The submission does not pertain to a tobacco product as defined in 21 U.S.C. 321(rr).

(2) The submission is not in English or does not contain complete English translations of any information submitted within.

(3) If submitted in an electronic format, the submission is in a format that FDA cannot process, read, review, and archive.

(4) The submission does not contain contact information, including the applicant's name and address.

(5) The submission is from a foreign applicant and does not identify an authorized U.S. agent, including the

agent's name and address, for the submission.

(6) The submission does not contain a required FDA form(s).

(7) The submission does not contain the following product-identifying information: The manufacturer of the tobacco product; the product name, including the brand and subbrand; the product category and subcategory; package type and package quantity; and characterizing flavor.

(8) The type of submission is not specified.

(9) The submission does not contain a signature of a responsible official, authorized to represent the applicant, who either resides in or has a place of business in the United States.

(10) For premarket tobacco applications, modified risk tobacco product applications, substantial equivalence applications, and exemption requests only: The submission does not include a valid claim of categorical exclusion in accordance with part 25 of this chapter, or an environmental assessment.

(b) If FDA finds that none of the reasons in paragraph (a) of this section exists for refusing to accept a premarket submission, FDA may accept the submission for processing and further review. FDA will send to the submitter an acknowledgement letter stating the submission has been accepted for processing and further review and will provide the premarket submission tracking number.

(c) If FDA finds that any of the reasons in paragraph (a) of this section exist for refusing to accept the submission, FDA will notify the submitter in writing of the reason(s) and that the submission has not been accepted, unless insufficient contact information was provided.

## PART 1107—ESTABLISHMENT REGISTRATION, PRODUCT LISTING, AND SUBSTANTIAL EQUIVALENCE REPORTS

AUTHORITY: 21 U.S.C. 387e(j) and 387j.

## Subpart A—Exemptions

## § 1107.1 Exemptions.

(a) *General requirements.* Under section 905(j)(3) of the Federal Food, Drug, and Cosmetic Act (21 U.S.C. 387e(j)(3)), FDA may exempt from the requirements relating to the demonstration that a tobacco product is substantially equivalent within the meaning of section 910 of the Federal Food, Drug, and Cosmetic Act (21 U.S.C. 387j), tobacco products that are modified by adding or deleting a tobacco additive, or increasing or decreasing the quantity of an existing tobacco additive, if FDA determines that:

(1) Such modification would be a minor modification of a tobacco product that can be sold under the Federal Food, Drug, and Cosmetic Act (a legally marketed tobacco product);

(2) A report under section 905(j)(1) intended to demonstrate substantial equivalence is not necessary to ensure that permitting the tobacco product to be marketed would be appropriate for protection of the public health; and

(3) An exemption is otherwise appropriate.

(b) *Request for an exemption under section 905(j)(3) of the Federal Food, Drug, and Cosmetic Act.* A request for an exemption from the requirement of demonstrating substantial equivalence may be made only by the manufacturer of a legally marketed tobacco product for a minor modification to that tobacco product. To request an exemption, the manufacturer must submit the request and all information supporting the request in an electronic format that FDA can process, review, and archive. If the manufacturer is unable to submit an exemption request in an electronic format, the manufacturer may submit a written request to the Center for Tobacco Products explaining in detail why the manufacturer cannot submit the request in an electronic format and requesting an alternative format. Such request must include an explanation of why an alternative format is necessary. All submissions, including requests to submit the information in an alternative format, requests for exemptions, and all supporting information must be legible and in the English

language. An exemption request must contain:

(1) The manufacturer's address and contact information;

(2) Identification of the tobacco product(s);

(3) A detailed explanation of the purpose of the modification;

(4) A detailed description of the modification, including a statement as to whether the modification involves adding or deleting a tobacco additive, or increasing or decreasing the quantity of an existing tobacco additive;

(5) A detailed explanation of why the modification is a minor modification of a tobacco product that can be sold under the Federal Food, Drug, and Cosmetic Act;

(6) A detailed explanation of why a report under section 905(j)(1) of the Federal Food, Drug, and Cosmetic Act intended to demonstrate substantial equivalence is not necessary to ensure that permitting the tobacco product to be marketed would be appropriate for protection of the public health;

(7) A certification (*i.e.*, a signed statement by a responsible official of the manufacturer) summarizing the supporting evidence and providing the rationale for the official's determination that the modification does not increase the tobacco product's appeal to or use by minors, toxicity, addictiveness, or abuse liability;

(8) Other information justifying an exemption; and

(9) An environmental assessment under part 25 of this chapter prepared in accordance with the requirements of § 25.40 of this chapter.

(c) *Exemption determination.* FDA will review the information submitted and determine whether to grant or deny an exemption request based on whether the criteria in section 905(j)(3) of the Federal Food, Drug, and Cosmetic Act are met. FDA may request additional information if necessary to make a determination. FDA will consider the exemption request withdrawn if the information is not provided within the requested timeframe.

(d) *Rescission of an exemption.* FDA may rescind an exemption if it finds that the exemption is not appropriate for the protection of public health. In general, FDA will rescind an exemption

only after notice and opportunity for a hearing under part 16 of this chapter is provided. However, FDA may rescind an exemption prior to notice and opportunity for a hearing under part 16 of this chapter if the continuance of the exemption presents a serious risk to public health. In that case, FDA will provide the manufacturer an opportunity for a hearing as soon as possible after the rescission.

[76 FR 38974, July 5, 2011]

### Subpart B [Reserved]

## PART 1140—CIGARETTES, SMOKELESS TOBACCO, AND COVERED TOBACCO PRODUCTS

### Subpart A—General Provisions

Sec.

- 1140.1 Scope.
- 1140.2 Purpose.
- 1140.3 Definitions.

### Subpart B—Prohibition of Sale and Distribution to Persons Younger Than 18 Years of Age

- 1140.10 General responsibilities of manufacturers, distributors, and retailers.
- 1140.12 Additional responsibilities of manufacturers.
- 1140.14 Additional responsibilities of retailers.
- 1140.16 Conditions of manufacture, sale, and distribution.

### Subpart C [Reserved]

### Subpart D—Labeling and Advertising

- 1140.30 Scope of permissible forms of labeling and advertising.
- 1140.32 Format and content requirements for labeling and advertising.
- 1140.34 Sale and distribution of nontobacco items and services, gifts, and sponsorship of events.

AUTHORITY: 21 U.S.C. 301 *et seq.*, Sec. 102, Pub. L. 111-31, 123 Stat. 1776.

SOURCE: 75 FR 13230, Mar. 19, 2010, unless otherwise noted.

### Subpart A—General Provisions

#### § 1140.1 Scope.

(a) This part sets out the restrictions under the Federal Food, Drug, and Cosmetic Act on the sale, distribution, and

use of cigarettes, smokeless tobacco, and covered tobacco products. Section 1140.16(d) sets out restrictions on the distribution of free samples for cigarettes, smokeless tobacco, and other tobacco products (as such term is defined in section 201 of the Federal Food, Drug, and Cosmetic Act).

(b) The failure to comply with any applicable provision in this part in the sale, distribution, and use of cigarettes, smokeless tobacco, covered tobacco products, or other tobacco products renders the product misbranded under the Federal Food, Drug, and Cosmetic Act.

(c) References in this part to regulatory sections of the Code of Federal Regulations are to chapter I of title 21, unless otherwise noted.

[81 FR 29102, May 10, 2016]

#### § 1140.2 Purpose.

The purpose of this part is to establish restrictions on the sale, distribution, and use of cigarettes, smokeless tobacco, and covered tobacco products in order to reduce the number of children and adolescents who use these products, and to reduce the life-threatening consequences associated with tobacco use.

[81 FR 29102, May 10, 2016]

#### § 1140.3 Definitions.

For the purposes of this part:

*Accessory* means any product that is intended or reasonably expected to be used with or for the human consumption of a tobacco product; does not contain tobacco and is not made or derived from tobacco; and meets either of the following:

- (1) Is not intended or reasonably expected to affect or alter the performance, composition, constituents, or characteristics of a tobacco product; or
- (2) Is intended or reasonably expected to affect or maintain the performance, composition, constituents, or characteristics of a tobacco product but

(i) Solely controls moisture and/or temperature of a stored product; or

(ii) Solely provides an external heat source to initiate but not maintain combustion of a tobacco product.

*Cigarette.* (1) Means a product that:

- (i) Is a tobacco product and

(ii) Meets the definition of the term “cigarette” in section 3(1) of the Federal Cigarette Labeling and Advertising Act; and

(2) Includes tobacco, in any form, that is functional in the product, which, because of its appearance, the type of tobacco used in the filler, or its packaging and labeling, is likely to be offered to, or purchased by, consumers as a cigarette or as roll-your-own tobacco.

*Cigarette tobacco* means any product that consists of loose tobacco that is intended for use by consumers in a cigarette. Unless otherwise stated, the requirements applicable to cigarettes under this chapter also apply to cigarette tobacco.

*Component or part* means any software or assembly of materials intended or reasonably expected:

(1) To alter or affect the tobacco product’s performance, composition, constituents, or characteristics; or

(2) To be used with or for the human consumption of a tobacco product. Component or part excludes anything that is an accessory of a tobacco product.

*Covered tobacco product* means any tobacco product deemed to be subject to the Federal Food, Drug, and Cosmetic Act under §1100.2 of this chapter, but excludes any component or part that is not made or derived from tobacco.

*Distributor* means any person who furthers the distribution of a tobacco product, whether domestic or imported, at any point from the original place of manufacture to the person who sells or distributes the product to individuals for personal consumption. Common carriers are not considered distributors for the purposes of this part.

*Importer* means any person who imports any tobacco product that is intended for sale or distribution to consumers in the United States.

*Manufacturer* means any person, including any repacker and/or relabeler, who manufactures, fabricates, assembles, processes, or labels a finished tobacco product.

*Nicotine* means the chemical substance named 3-(1-Methyl-2-pyrrolidinyl)pyridine or C[10]H[14]N[2], including any salt or complex of nicotine.

*Package or packaging* means a pack, box, carton, or container of any kind or, if no other container, any wrapping (including cellophane) in which a tobacco product is offered for sale, sold, or otherwise distributed to consumers.

*Point of sale* means any location at which a consumer can purchase or otherwise obtain tobacco products for personal consumption.

*Retailer* means any person who sells tobacco products to individuals for personal consumption, or who operates a facility where vending machines or self-service displays are permitted under this part.

*Roll-your-own tobacco* means any tobacco product that, because of its appearance, type, packaging, or labeling, is suitable for use and likely to be offered to, or purchased by, consumers as tobacco for making cigarettes.

*Smokeless tobacco* means any tobacco product that consists of cut, ground, powdered, or leaf tobacco and that is intended to be placed in the oral or nasal cavity.

*Tobacco product.* As stated in section 201(rr) of the Federal Food, Drug, and Cosmetic Act in relevant part, a tobacco product:

(1) Means any product made or derived from tobacco that is intended for human consumption, including any component, part, or accessory of a tobacco product (except for raw materials other than tobacco used in manufacturing a component, part, or accessory of a tobacco product) and

(2) Does not mean an article that is a drug under section 201(g)(1) of the Federal Food, Drug, and Cosmetic Act, a device under section 201(h) of the Federal Food, Drug, and Cosmetic Act, or a combination product described in section 503(g) of the Federal Food, Drug, and Cosmetic Act.

[81 FR 29102, May 10, 2016]

### **Subpart B—Prohibition of Sale and Distribution to Persons Younger Than 18 Years of Age**

#### **§ 1140.10 General responsibilities of manufacturers, distributors, and retailers.**

Each manufacturer, distributor, importer, and retailer is responsible for

## § 1140.12

ensuring that the cigarettes, smokeless tobacco, or covered tobacco products it manufactures, labels, advertises, packages, distributes, imports, sells, or otherwise holds for sale comply with all applicable requirements under this part.

[81 FR 29103, May 10, 2016]

### § 1140.12 Additional responsibilities of manufacturers.

In addition to the other responsibilities under this part, each manufacturer shall remove from each point of sale all self-service displays, advertising, labeling, and other items that the manufacturer owns that do not comply with the requirements under this part.

### § 1140.14 Additional responsibilities of retailers.

(a) In addition to the other requirements under this part, each cigarette and smokeless tobacco retailer is responsible for ensuring that all sales of cigarettes or smokeless tobacco to any person comply with the following requirements:

(1) No retailer may sell cigarettes or smokeless tobacco to any person younger than 18 years of age;

(2)(i) Except as otherwise provided in paragraph (a)(2)(ii) of this section and in §1140.16(c)(2)(i), each retailer must verify by means of photographic identification containing the bearer's date of birth that no person purchasing the product is younger than 18 years of age;

(ii) No such verification is required for any person over the age of 26;

(3) Except as otherwise provided in §1140.16(c)(2)(ii), a retailer may sell cigarettes or smokeless tobacco only in a direct, face-to-face exchange without the assistance of any electronic or mechanical device (such as a vending machine);

(4) No retailer may break or otherwise open any cigarette or smokeless tobacco package to sell or distribute individual cigarettes or a number of unpackaged cigarettes that is smaller than the quantity in the minimum cigarette package size defined in §1140.16(b), or any quantity of cigarette tobacco or smokeless tobacco that is smaller than the smallest package dis-

## 21 CFR Ch. I (4-1-20 Edition)

tributed by the manufacturer for individual consumer use; and

(5) Each retailer must ensure that all self-service displays, advertising, labeling, and other items, that are located in the retailer's establishment and that do not comply with the requirements of this part, are removed or are brought into compliance with the requirements under this part.

(b) Notwithstanding the requirements in paragraph (a) of this section and in addition to the other requirements under this part, each retailer of covered tobacco products is responsible for ensuring that all sales of such covered tobacco products to any person comply with the following requirements:

(1) No retailer may sell covered tobacco products to any person younger than 18 years of age;

(2)(i) Except as otherwise provided in paragraph (a)(2)(ii) of this section and in §1140.16(c)(2)(i), each retailer must verify by means of photographic identification containing the bearer's date of birth that no person purchasing the product is younger than 18 years of age;

(ii) No such verification is required for any person over the age of 26; and

(3) A retailer may not sell covered tobacco products with the assistance of any electronic or mechanical device (such as a vending machine), except in facilities where the retailer ensures that no person younger than 18 years of age is present, or permitted to enter, at any time.

[81 FR 29103, May 10, 2016]

### § 1140.16 Conditions of manufacture, sale, and distribution.

(a) *Restriction on product names.* A manufacturer shall not use a trade or brand name of a nontobacco product as the trade or brand name for a cigarette or smokeless tobacco product, except for a tobacco product whose trade or brand name was on both a tobacco product and a nontobacco product that were sold in the United States on January 1, 1995.

(b) *Minimum cigarette package size.* Except as otherwise provided under this section, no manufacturer, distributor, or retailer may sell or cause to be sold, or distribute or cause to be distributed,

any cigarette package that contains fewer than 20 cigarettes.

(c) *Vending machines, self-service displays, mail-order sales, and other "impersonal" modes of sale.* (1) Except as otherwise provided under this section, a retailer may sell cigarettes and smokeless tobacco only in a direct, face-to-face exchange between the retailer and the consumer. Examples of methods of sale that are not permitted include vending machines and self-service displays.

(2) *Exceptions.* The following methods of sale are permitted:

(i) Mail-order sales, excluding mail-order redemption of coupons and distribution of free samples through the mail; and

(ii) Vending machines (including vending machines that sell packaged, single cigarettes) and self-service displays that are located in facilities where the retailer ensures that no person younger than 18 years of age is present, or permitted to enter, at any time.

(d)(1) Except as provided in paragraph (d)(2) of this section, no manufacturer, distributor, or retailer may distribute or cause to be distributed any free samples of cigarettes, smokeless tobacco, or other tobacco products (as such term is defined in section 201 of the Federal Food, Drug, and Cosmetic Act).

(2)(i) Paragraph (d)(1) of this section does not prohibit a manufacturer, distributor, or retailer from distributing or causing to be distributed free samples of smokeless tobacco in a qualified adult-only facility.

(ii) Paragraph (d)(2) of this section does not affect the authority of a State or local government to prohibit or otherwise restrict the distribution of free samples of smokeless tobacco.

(iii) For purposes of paragraph (d) of this section, the term "qualified adult-only facility" means a facility or restricted area that:

(A) Requires each person present to provide to a law enforcement officer (whether on or off duty) or to a security guard licensed by a governmental entity government-issued identification showing a photograph and at least the minimum age established by appli-

cable law for the purchase of smokeless tobacco;

(B) Does not sell, serve, or distribute alcohol;

(C) Is not located adjacent to or immediately across from (in any direction) a space that is used primarily for youth-oriented marketing, promotional, or other activities;

(D) Is a temporary structure constructed, designated, and operated as a distinct enclosed area for the purpose of distributing free samples of smokeless tobacco in accordance with this paragraph (d)(2) of this section;

(E) Is enclosed by a barrier that:

(1) Is constructed of, or covered with, an opaque material (except for entrances and exits);

(2) Extends from no more than 12 inches above the ground or floor (which area at the bottom of the barrier must be covered with material that restricts visibility but may allow airflow) to at least 8 feet above the ground or floor (or to the ceiling); and

(3) Prevents persons outside the qualified adult-only facility from seeing into the qualified adult-only facility, unless they make unreasonable efforts to do so; and

(F) Does not display on its exterior:

(1) Any tobacco product advertising;

(2) A brand name other than in conjunction with words for an area or enclosure to identify an adult-only facility; or

(3) Any combination of words that would imply to a reasonable observer that the manufacturer, distributor, or retailer has a sponsorship that would violate § 1140.34(c).

(iv) Distribution of samples of smokeless tobacco under paragraph (d)(2) of this section permitted to be taken out of the qualified adult-only facility shall be limited to one package per adult consumer containing no more than 0.53 ounces (15 grams) of smokeless tobacco. If such package of smokeless tobacco contains individual portions of smokeless tobacco, the individual portions of smokeless tobacco shall not exceed eight individual portions, and the collective weight of such individual portions shall not exceed 0.53 ounces (15 grams). Any manufacturer, distributor, or retailer who distributes or causes to be distributed free

**§ 1140.30**

**21 CFR Ch. I (4–1–20 Edition)**

samples also shall take reasonable steps to ensure that the amounts in this paragraph (d)(2)(iv) are limited to one such package per adult consumer per day.

(3) Notwithstanding paragraph (d)(2) of this section, no manufacturer, distributor, or retailer may distribute or cause to be distributed any free samples of smokeless tobacco:

(i) To a sports team or entertainment group; or

(ii) At any football, basketball, baseball, soccer, or hockey event or any other sporting or entertainment event determined by the Secretary to be covered by paragraph (d)(3) of this section.

(4) The Secretary shall implement a program to ensure compliance with paragraph (d) of this section and submit a report to the Congress on such compliance not later than 18 months after the date of enactment of the Family Smoking Prevention and Tobacco Control Act.

(5) Nothing in paragraph (d) of this section shall be construed to authorize any person to distribute or cause to be distributed any sample of a tobacco product to any individual who has not attained the minimum age established by applicable law for the purchase of such product.

(e) *Restrictions on labels, labeling, and advertising.* No manufacturer, distributor, or retailer may sell or distribute, or cause to be sold or distributed, cigarettes or smokeless tobacco with labels, labeling, or advertising not in compliance with subpart D of this part, and other applicable requirements.

**Subpart C [Reserved]**

**Subpart D—Labeling and Advertising**

**§ 1140.30 Scope of permissible forms of labeling and advertising.**

(a)(1) A manufacturer, distributor, or retailer may, in accordance with this subpart D, disseminate or cause to be disseminated advertising or labeling which bears a cigarette or smokeless tobacco brand name (alone or in conjunction with any other word) or any other indicia of tobacco product identification, in newspapers; in magazines;

in periodicals or other publications (whether periodic or limited distribution); on billboards, posters, and placards; in nonpoint-of-sale promotional material (including direct mail); in point-of-sale promotional material; and in audio or video formats delivered at a point-of-sale.

(2) A manufacturer, distributor, or retailer intending to disseminate, or to cause to be disseminated, advertising or labeling for cigarettes or smokeless tobacco in a medium that is not listed in paragraph (a)(1) of this section, shall notify the agency 30 days prior to the use of such medium. The notice shall describe the medium and discuss the extent to which the advertising or labeling may be seen by persons younger than 18 years of age. The manufacturer, distributor, or retailer shall send this notice to the Office of Compliance and Enforcement, Center for Tobacco Products, Food and Drug Administration, Document Control Center, 10903 New Hampshire Ave., Bldg. 71, Rm. G335, Silver Spring, MD 20993.

(b) [Reserved]

(c) This subpart D does not apply to cigarette or smokeless tobacco package labels.

[75 FR 13230, Mar. 19, 2010, as amended at 83 FR 13183, Mar. 28, 2018]

**§ 1140.32 Format and content requirements for labeling and advertising.**

(a) Except as provided in paragraph (b) of this section, each manufacturer, distributor, and retailer advertising or causing to be advertised, disseminating or causing to be disseminated, any labeling or advertising for cigarettes or smokeless tobacco shall use only black text on a white background. This section does not apply to advertising:

(1) In any facility where vending machines and self-service displays are permitted under this part, provided that the advertising is not visible from outside the facility and that it is affixed to a wall or fixture in the facility; or

(2) Appearing in any publication (whether periodic or limited distribution) that the manufacturer, distributor, or retailer demonstrates is an adult publication. For the purposes of this section, an adult publication is a



newspaper, magazine, periodical, or other publication:

(i) Whose readers younger than 18 years of age constitute 15 percent or less of the total readership as measured by competent and reliable survey evidence; and

(ii) That is read by fewer than 2 million persons younger than 18 years of age as measured by competent and reliable survey evidence.

(b) Labeling and advertising in an audio or video format shall be limited as follows:

(1) Audio format shall be limited to words only with no music or sound effects.

(2) Video formats shall be limited to static black text only on a white background. Any audio with the video shall be limited to words only with no music or sound effects.

**§ 1140.34 Sale and distribution of non-tobacco items and services, gifts, and sponsorship of events.**

(a) No manufacturer and no distributor of imported cigarettes or smokeless tobacco may market, license, distribute, sell, or cause to be marketed, licensed, distributed, or sold any item (other than cigarettes or smokeless tobacco or roll-your-own paper) or service, which bears the brand name (alone or in conjunction with any other word), logo, symbol, motto, selling message, recognizable color or pattern of colors, or any other indicia of product identification identical or similar to, or identifiable with, those used for any brand of cigarettes or smokeless tobacco.

(b) No manufacturer, distributor, or retailer may offer or cause to be offered any gift or item (other than cigarettes or smokeless tobacco) to any person purchasing cigarettes or smokeless tobacco in consideration of the purchase thereof, or to any person in consideration of furnishing evidence, such as credits, proofs-of-purchase, or coupons, of such a purchase.

(c) No manufacturer, distributor, or retailer may sponsor or cause to be sponsored any athletic, musical, artistic, or other social or cultural event, or any entry or team in any event, in the brand name (alone or in conjunction with any other word), logo, symbol,

motto, selling message, recognizable color or pattern of colors, or any other indicia of product identification identical or similar to, or identifiable with, those used for any brand of cigarettes or smokeless tobacco. Nothing in this paragraph prevents a manufacturer, distributor, or retailer from sponsoring or causing to be sponsored any athletic, musical, artistic, or other social or cultural event, or team or entry, in the name of the corporation which manufactures the tobacco product, provided that both the corporate name and the corporation were registered and in use in the United States prior to January 1, 1995, and that the corporate name does not include any brand name (alone or in conjunction with any other word), logo, symbol, motto, selling message, recognizable color or pattern of colors, or any other indicia of product identification identical or similar to, or identifiable with, those used for any brand of cigarettes or smokeless tobacco.

**PART 1141—CIGARETTE PACKAGE AND ADVERTISING WARNINGS (Eff. until 6-18-21)**

**Subpart A—General Provisions**

Sec.

1141.1 Scope.

1141.3 Definitions.

**Subpart B—Cigarette Package and Advertising Warnings**

1141.10 Required warnings.

1141.12 Incorporation by reference of required warnings.

1141.14 Misbranding of cigarettes.

**Subpart C—Additional Disclosure Requirements for Cigarette Packages and Advertising**

1141.16 Disclosures regarding cessation.

AUTHORITY: 15 U.S.C. 1333; 21 U.S.C. 371, 387c, 387f; Secs. 201 and 202, Pub. L. 111–31, 123 Stat. 1776.

SOURCE: 76 FR 36753, June 22, 2011, unless otherwise noted.

EFFECTIVE DATE NOTE: At 85 FR 15708, Mar. 8, 2020, part 1141 was revised, effective June 18, 2021. For the convenience of the user, the new part 1141 follows the text of this part.

**Subpart A—General Provisions****§ 1141.1 Scope.**

(a) This part sets forth the requirements for the display of health warnings on cigarette packages and in advertisements for cigarettes. FDA may require additional statements to be displayed on packages and in advertisements under the Federal Food, Drug, and Cosmetic Act or other authorities.

(b) The requirements of this part do not apply to manufacturers or distributors of cigarettes that do not manufacture, package, or import cigarettes for sale or distribution within the United States.

(c) A cigarette retailer shall not be considered in violation of this part as it applies to the display of health warnings on a cigarette package if the package:

- (1) Contains a health warning;
- (2) Is supplied to the retailer by a license- or permit-holding tobacco product manufacturer, importer, or distributor; and
- (3) Is not altered by the retailer in a way that is material to the requirements of section 4(a) of the Federal Cigarette Labeling and Advertising Act (15 U.S.C. 1333(a)) or this part, including by obscuring the warning, by reducing its size, by severing it in whole or in part, or by otherwise changing it in a material way.

(d) A cigarette retailer shall not be considered in violation of this part as it applies to the display of health warnings in an advertisement for cigarettes if the advertisement is not created by or on behalf of the retailer and the retailer is not otherwise responsible for the inclusion of the required warnings. This paragraph shall not relieve a retailer of liability if the retailer displays, in a location open to the public, an advertisement that does not contain a health warning or that contains a warning that has been altered by the retailer in a way that is material to the requirements of section 4(b) of the Federal Cigarette Labeling and Advertising Act (15 U.S.C. 1333(b)), this part, or section 4(c) of the Federal Cigarette Labeling and Advertising Act (15 U.S.C. 1333(c)), including by obscuring the warning, by reducing its size, by sev-

ering it in whole or in part, or by otherwise changing it in a material way.

**§ 1141.3 Definitions.**

For the purposes of this part,

*Cigarette* means:

- (1) Any roll of tobacco wrapped in paper or in any substance not containing tobacco; and
- (2) Any roll of tobacco wrapped in any substance containing tobacco which, because of its appearance, the type of tobacco used in the filler, or its packaging and labeling, is likely to be offered to, or purchased by, consumers as a cigarette described in paragraph (1) of this definition.

*Commerce* means:

- (1) Commerce between any State, the District of Columbia, the Commonwealth of Puerto Rico, Guam, the U.S. Virgin Islands, American Samoa, Wake Island, Midway Islands, Kingman Reef, or Johnston Island and any place outside thereof;
- (2) Commerce between points in any State, the District of Columbia, the Commonwealth of Puerto Rico, Guam, the U.S. Virgin Islands, American Samoa, Wake Island, Midway Islands, Kingman Reef, or Johnston Island, but through any place outside thereof; or
- (3) Commerce wholly within the District of Columbia, Guam, the U.S. Virgin Islands, American Samoa, Wake Island, Midway Island, Kingman Reef, or Johnston Island.

*Distributor* means any person who furthers the distribution of cigarettes at any point from the original place of manufacture to the person who sells or distributes the product to individuals for personal consumption. Common carriers are not considered distributors for the purposes of this part.

*Front panel* and *rear panel* mean the two largest sides or surfaces of the package.

*Importer* means any person who imports any cigarette that is intended for sale or distribution to consumers in the United States.

*Manufacturer* means any person, including any repacker or relabeler, who manufactures, fabricates, assembles, processes, or labels a finished cigarette product.

*Package* means a pack, box, carton, or container of any kind in which cigarettes are offered for sale, sold, or otherwise distributed to consumers.

*Person* means an individual, partnership, corporation, or any other business or legal entity.

*Required warning* means the combination of one of the textual warning statements and its accompanying color graphic, which are set forth in “Cigarette Required Warnings,” which is incorporated by reference at §1141.12.

*Retailer* means any person who sells cigarettes to individuals for personal consumption, or who operates a facility where vending machines or self-service displays of cigarettes are permitted.

*United States*, when used in a geographical sense, includes the several States, the District of Columbia, the Commonwealth of Puerto Rico, Guam, the U.S. Virgin Islands, American Samoa, Wake Island, Midway Islands, Kingman Reef, and Johnston Island. The term “State” includes any political division of any State.

### Subpart B—Cigarette Package and Advertising Warnings

#### § 1141.10 Required warnings.

(a) *Packages*. (1) It shall be unlawful for any person to manufacture, package, sell, offer to sell, distribute, or import for sale or distribution within the United States any cigarettes the package of which fails to bear, in accordance with section 4 of the Federal Cigarette Labeling and Advertising Act (15 U.S.C. 1333) and this part, one of the required warnings on the front and the rear panels.

(2) The required warning shall be obtained from the electronic images contained in “Cigarette Required Warnings,” which is incorporated by reference at §1141.12, and accurately reproduced as specified in “Cigarette Required Warnings.”

(3) The required warning shall appear directly on the package and shall be clearly visible underneath the cellophane or other clear wrapping.

(4) The required warning shall be located in the upper portion of the front and rear panels of the package and shall comprise at least the top 50 per-

cent of these panels; *Provided, however*, that on cigarette cartons, the required warning shall be located on the left side of the front and rear panels of the carton and shall comprise at least the left 50 percent of these panels.

(5) The required warning shall be positioned such that the text of the required warning and the other information on that panel of the package have the same orientation.

(b) *Advertisements*. (1) It shall be unlawful for any manufacturer, importer, distributor, or retailer of cigarettes to advertise or cause to be advertised within the United States any cigarette unless its advertising bears, in accordance with section 4 of the Federal Cigarette Labeling and Advertising Act (15 U.S.C. 1333) and this part, one of the required warnings.

(2) The text in each required warning shall be in the English language, except that:

(i) In the case of an advertisement that appears in a non-English publication, the text in the required warning shall appear in the predominant language of the publication whether or not the advertisement is in English; and

(ii) In the case of an advertisement that appears in an English language publication but that is not in English, the text in the required warning shall appear in the same language as that principally used in the advertisement.

(3) For English-language and Spanish-language warnings, each required warning shall be obtained from the electronic images contained in “Cigarette Required Warnings,” which is incorporated by reference at §1141.12, and accurately reproduced as specified in “Cigarette Required Warnings.”

(4) For foreign-language warnings, except for Spanish-language warnings, each required warning shall be obtained from the electronic images contained in “Cigarette Required Warnings,” which is incorporated by reference at §1141.12, and accurately reproduced as specified in “Cigarette Required Warnings,” including the insertion of a true and accurate translation of the textual warning. The inserted textual warning must comply with the requirements of section 4(b)(2) of the

## § 1141.12

## 21 CFR Ch. I (4–1–20 Edition)

Federal Cigarette Labeling and Advertising Act (15 U.S.C. 1333(b)(2)).

(5) The required warning shall occupy at least 20 percent of the area of each advertisement, and shall be placed in accordance with the requirements in the Federal Cigarette Labeling and Advertising Act.

(c) *Irremovable or permanent warnings.* The required warnings shall be indelibly printed on or permanently affixed to the package or advertisement. Such warnings, for example, must not be printed or placed on a label affixed to a clear outer wrapper that is likely to be removed to access the product within the package.

### § 1141.12 Incorporation by reference of required warnings.

“Cigarette Required Warnings” Edition 1.0 (June 2011), consisting of electronic files, U.S. Food and Drug Administration, referred to at § 1141.3, § 1141.10(a) and (b), and § 1141.16(a), is incorporated by reference into this section with the approval of the Director of the Federal Register under 5 U.S.C. 552(a) and 1 CFR part 51. To enforce any edition other than that specified in this section, FDA must publish notice of change in the FEDERAL REGISTER and the material must be available to the public. All approved material is available for inspection at the National Archives and Records Administration (NARA). For information on the availability of this material at NARA, call 202-741-6030 or go to [http://www.archives.gov/federal\\_register/code\\_of\\_federal\\_regulations/ibr\\_locations.html](http://www.archives.gov/federal_register/code_of_federal_regulations/ibr_locations.html). Also, you may obtain a copy of the material by contacting the Center for Tobacco Products, Food and Drug Administration, Office of Health Communication and Education, ATTN: Cigarette Warning File Requests, 9200 Corporate Blvd., Rockville, MD 20850, 1-877-CTP-1373, or [cigarettewarningfiles@fda.hhs.gov](mailto:cigarettewarningfiles@fda.hhs.gov). You may also obtain the material at <http://www.fda.gov/cigarettewarningfiles>.

### § 1141.14 Misbranding of cigarettes.

(a) A cigarette shall be deemed to be misbranded under section 903(a)(1) of the Federal Food, Drug, and Cosmetic Act if its package does not bear one of the required warnings in accordance

with section 4 of the Federal Cigarette Labeling and Advertising Act (15 U.S.C. 1333) and this part. A cigarette shall be deemed to be misbranded under section 903(a)(7)(A) of the Federal Food, Drug, and Cosmetic Act if its advertising does not bear one of the required warnings in accordance with section 4 of the Federal Cigarette Labeling and Advertising Act (15 U.S.C. 1333) and this part.

(b) A cigarette advertisement or package will be deemed to include a brief statement of relevant warnings for the purposes of section 903(a)(8) of the Federal Food, Drug, and Cosmetic Act if it bears one of the required warnings in accordance with section 4 of the Federal Cigarette Labeling and Advertising Act (15 U.S.C. 1333) and this part. A cigarette distributed or offered for sale in any State shall be deemed to be misbranded under section 903(a)(8) of the Federal Food, Drug, and Cosmetic Act unless the manufacturer, packer, or distributor includes in all advertisements and packages issued or caused to be issued by the manufacturer, packer, or distributor with respect to the cigarette one of the required warnings in accordance with section 4 of the Federal Cigarette Labeling and Advertising Act (15 U.S.C. 1333) and this part.

## Subpart C—Additional Disclosure Requirements for Cigarette Packages and Advertising

### § 1141.16 Disclosures regarding cessation.

(a) The required warning shall include a reference to a smoking cessation assistance resource in accordance with, and as specified in, “Cigarette Required Warnings” (incorporated by reference at § 1141.12).

(b) In meeting the smoking cessation needs of an individual caller, the smoking cessation assistance resource required to be referenced by paragraph (a) of this section must, as appropriate:

(1) Provide factual information about the harms to health associated with cigarette smoking and the health benefits of quitting smoking;

(2) Provide factual information about what smokers can expect when trying to quit;

(3) Provide practical advice (problem solving/skills training) about how to deal with common issues faced by smokers trying to quit;

(4) Provide evidence-based advice about how to formulate a plan to quit smoking;

(5) Provide evidence-based information about effective relapse prevention strategies;

(6) Provide factual information on smoking cessation treatments, including FDA-approved cessation medications; and

(7) Provide information, advice, and support that is evidence-based, unbiased (including with respect to products, services, persons, and other entities), and relevant to tobacco cessation.

(c) The smoking cessation resource must:

(1) Other than as described in this section, not advertise or promote any particular product or service;

(2) Except to meet the particularized needs of an individual caller as determined in the context of individual counseling, not selectively present information about a subset of FDA-approved cessation products or product categories while failing to mention other FDA-approved cessation products or product categories;

(3) Not provide or otherwise encourage the use of any drug or other medical product that FDA has not approved for tobacco cessation;

(4) Not encourage the use of any non-evidence-based smoking cessation practices;

(5) Ensure that staff providing smoking cessation information, advice, and support are trained specifically to help smokers quit by delivering unbiased and evidence-based information, advice, and support; and

(6) Maintain appropriate controls to ensure the criteria described in paragraphs (b) and (c) of this section are met.

(d) If the Secretary of the Department of Health and Human Services (Secretary) determines that a part of the smoking cessation assistance resource referenced by paragraph (a) of this section does not meet the criteria described in paragraphs (b) and (c) of this section, the Secretary shall take

appropriate steps to address the non-compliance.

EFFECTIVE DATE NOTE: At 85 FR 15708, Mar. 8, 2020, part 1141 was revised, effective June 18, 2021. For the convenience of the user, the new part 1141 is set forth as follows:

## **PART 1141—REQUIRED WARNINGS FOR CIGARETTE PACKAGES AND ADVERTISEMENTS (Eff. 6-18-21)**

### **Subpart A—General Provisions**

Sec.

1141.1 Scope.

1141.3 Definitions.

1141.5 Incorporation by reference.

### **Subpart B—Required Warnings for Cigarette Packages and Advertisements**

1141.10 Required warnings.

1141.12 Misbranding of cigarettes.

AUTHORITY: 15 U.S.C. 1333; 21 U.S.C. 371, 374, 387c, 387e, 387i; Secs. 201 and 202, Pub. L. 111-31, 123 Stat. 1776.

### **Subpart A—General Provisions**

#### **§ 1141.1 Scope.**

(a) This part sets forth the requirements for the display of required warnings on cigarette packages and in advertisements for cigarettes.

(b) The requirements of this part do not apply to manufacturers or distributors of cigarettes that do not manufacture, package, or import cigarettes for sale or distribution within the United States.

(c) A cigarette retailer will not be in violation of § 1141.10 for packaging that:

(1) Contains a warning;

(2) Is supplied to the retailer by a licensee or permit-holding tobacco product manufacturer, or distributor; and

(3) Is not altered by the retailer in a way that is material to the requirements of section 4 of the Federal Cigarette Labeling and Advertising Act (15 U.S.C. 1333) or this part.

(d) Section 1141.10(d) applies to a cigarette retailer only if that retailer is responsible for or directs the warnings required under § 1141.10 for advertising. However, this paragraph (d) does not relieve a retailer of liability if the retailer displays, in a location open to the public, an advertisement that does not contain a warning or has been altered by the retailer in a way that is material to the requirements of section 4 of the Federal Cigarette Labeling and Advertising Act or this part.

#### **§ 1141.3 Definitions.**

For purposes of this part:

*Cigarette* means—

(1) Any roll of tobacco wrapped in paper or in any substance not containing tobacco; and

(2) Any roll of tobacco wrapped in any substance containing tobacco which, because of its appearance, the type of tobacco used in the filler, or its packaging and labeling, is likely to be offered to, or purchased by, consumers as a cigarette described in paragraph (1) of this definition.

*Commerce* means:

(1) Commerce between any State, the District of Columbia, the Commonwealth of Puerto Rico, Guam, the Virgin Islands, American Samoa, Wake Island, Midway Islands, Kingman Reef, or Johnston Island and any place outside thereof;

(2) Commerce between points in any State, the District of Columbia, the Commonwealth of Puerto Rico, Guam, the Virgin Islands, American Samoa, Wake Island, Midway Islands, Kingman Reef, or Johnston Island, but through any place outside thereof; or

(3) Commerce wholly within the District of Columbia, Guam, the Virgin Islands, American Samoa, Wake Island, Midway Island, Kingman Reef, or Johnston Island.

*Distributor* means any person who furthers the distribution of cigarettes, whether domestic or imported, at any point from the original place of manufacture to the person who sells or distributes the product to individuals for personal consumption. Common carriers are not considered distributors for the purposes of this part.

*Front panel* and *rear panel* mean the two largest sides or surfaces of the package.

*Manufacturer* means any person, including any repacker or relabeler, who manufactures, fabricates, assembles, processes, or labels a finished cigarette product; or imports any cigarette that is intended for sale or distribution to consumers in the United States.

*Package* or *packaging* means a pack, box, carton, or container of any kind in which cigarettes are offered for sale, sold, or otherwise distributed to consumers.

*Person* means an individual, partnership, corporation, or any other business or legal entity.

*Retailer* means any person who sells cigarettes to individuals for personal consumption, or who operates a facility where vending machines or self-service displays of cigarettes are permitted.

*United States*, when used in a geographical sense, includes the several States, the District of Columbia, the Commonwealth of Puerto Rico, Guam, the Virgin Islands, American Samoa, Wake Island, Midway Islands, Kingman Reef, and Johnston Island. The term “State” includes any political division of any State.

#### § 1141.5 Incorporation by reference.

(a) Certain material is incorporated by reference into this part with the approval of the Director of the Federal Register under 5 U.S.C. 552(a) and 1 CFR part 51. All approved material is available for inspection at U.S.

Food and Drug Administration, Division of Dockets Management, 5630 Fishers Lane, Rm. 1061, Rockville, MD 20852, and is available from the source listed in paragraph (b) of this section. It is also available for inspection at the National Archives and Records Administration (NARA). For information on the availability of this material at NARA, email [fedreg.legal@nara.gov](mailto:fedreg.legal@nara.gov) or go to [www.archives.gov/federal-register/cfr/ibr-locations.html](http://www.archives.gov/federal-register/cfr/ibr-locations.html).

(b) Center for Tobacco Products, U.S. Food and Drug Administration, 10903 New Hampshire Ave., Silver Spring, MD 20993; 1-888-463-6332. You may also obtain the material at <https://www.fda.gov/cigarette-warning-files>.

(1) “Required Cigarette Health Warnings, 2020”, IBR approved for § 1141.10.

(2) [Reserved]

### Subpart B—Required Warnings for Cigarette Packages and Advertisements

#### § 1141.10 Required warnings.

(a) *Required warnings.* A required warning must include the following:

(1) One of the following textual warning label statements:

(i) WARNING: Tobacco smoke can harm your children.

(ii) WARNING: Tobacco smoke causes fatal lung disease in nonsmokers.

(iii) WARNING: Smoking causes type 2 diabetes, which raises blood sugar.

(iv) WARNING: Smoking reduces blood flow to the limbs, which can require amputation.

(v) WARNING: Smoking causes cataracts, which can lead to blindness.

(vi) WARNING: Smoking causes bladder cancer, which can lead to bloody urine.

(vii) WARNING: Smoking reduces blood flow, which can cause erectile dysfunction.

(viii) WARNING: Smoking causes head and neck cancer.

(ix) WARNING: Smoking can cause heart disease and strokes by clogging arteries.

(x) WARNING: Smoking during pregnancy stunts fetal growth.

(xi) WARNING: Smoking causes COPD, a lung disease that can be fatal.

(2) A color graphic to accompany the textual warning label statement.

(b) *Accurately reproduced.* Each required warning, comprising a combination of a textual warning label statement and its accompanying color graphic, must be accurately reproduced as shown in the materials contained in “Required Cigarette Health Warnings, 2020,” which is incorporated by reference at § 1141.5.

(c) *Packages.* It is unlawful for any person to manufacture, package, sell, offer to sell, distribute, or import for sale or distribution within the United States any cigarettes unless the package of which bears a required

warning in accordance with section 4 of the Federal Cigarette Labeling and Advertising Act and this part.

(1) The required warning must appear directly on the package and must be clearly visible underneath any cellophane or other clear wrapping.

(2) The required warning must comprise at least the top 50 percent of the front and rear panels; provided, however, that on cigarette cartons, the required warning must be located on the left side of the front and rear panels of the carton and must comprise at least the left 50 percent of these panels.

(3) The required warning must be positioned such that the text of the required warning and the other information on that panel of the package have the same orientation.

(d) *Advertisements.* It is unlawful for any manufacturer, distributor, or retailer of cigarettes to advertise or cause to be advertised within the United States any cigarette unless each advertisement bears a required warning in accordance with section 4 of the Federal Cigarette Labeling and Advertising Act and this part.

(1) For print advertisements and other advertisements with a visual component (including, for example, advertisements on signs, retail displays, internet web pages, digital platforms, mobile applications, and email correspondence), the required warning must appear directly on the advertisement.

(2) The required warning must comprise at least 20 percent of the area of the advertisement in a conspicuous and prominent format and location at the top of each advertisement within the trim area, if any.

(3) The text in each required warning must be in the English language, except as follows:

(i) In the case of an advertisement that appears in a non-English medium, the text in the required warning must appear in the predominant language of the medium whether or not the advertisement is in English; and

(ii) In the case of an advertisement that appears in an English language medium but that is not in English, the text in the required warning must appear in the same language as that principally used in the advertisement.

(4) For English-language and Spanish-language warnings, each required warning must be accurately reproduced as shown in the materials contained in "Required Cigarette Health Warnings, 2020," which is incorporated by reference at § 1141.5.

(5) For non-English-language warnings, other than Spanish-language warnings, each required warning must be accurately reproduced as shown in the materials contained in "Required Cigarette Health Warnings, 2020," which is incorporated by reference at § 1141.5, including the substitution and insertion of a true and accurate translation of the textual warning label statement in place of the

English language version. The inserted textual warning label statement must comply with the requirements of section 4 of the Federal Cigarette Labeling and Advertising Act, including area and other formatting requirements, and this part.

(e) *Irremovable or permanent warnings.* The required warnings must be indelibly printed on or permanently affixed to the package or advertisement. These warnings, for example, must not be printed or placed on a label affixed to a clear outer wrapper that is likely to be removed to access the product within the package.

(f) *Sale or distribution.* No person may manufacture, package, sell, offer for sale, distribute, or import for sale or distribution within the United States cigarettes whose packages or advertisements are not in compliance with section 4 of the Federal Cigarette Labeling and Advertising Act and this part, except as provided by § 1141.1(c) and (d).

(g) *Marketing requirements—(1) Random display.* The required warnings for packages specified in paragraph (a) of this section must be randomly displayed in each 12-month period, in as equal a number of times as is possible on each brand of the product and be randomly distributed in all areas of the United States in which the product is marketed in accordance with a plan submitted by the tobacco product manufacturer, distributor, or retailer to, and approved by, the Food and Drug Administration.

(2) *Rotation.* The required warnings for advertisements specified in paragraph (a) of this section must be rotated quarterly in alternating sequence in advertisements for each brand of cigarettes in accordance with a plan submitted by the tobacco product manufacturer, distributor, retailer to, and approved by, the Food and Drug Administration.

(3) *Review.* The Food and Drug Administration will review each plan submitted under this section and approve it if the plan:

(i) Will provide for the equal distribution and display on packaging and the rotation required in advertising under this subsection; and

(ii) Assures that all of the labels required under this section will be displayed by the tobacco product manufacturer, distributor, or retailer at the same time.

(4) *Record retention.* Each tobacco product manufacturer required to randomly and equally display and distribute warnings on packaging or rotate warnings in advertisements in accordance with an FDA-approved plan under section 4 of the Federal Cigarette Labeling and Advertising Act and this part must maintain a copy of such FDA-approved plan and make it available for inspection and copying by officers or employees duly designated by the Secretary of Health and Human Services. The FDA-approved plan

must be retained while in effect and for a period of not less than 4 years from the date it was last in effect.

**§ 1141.12 Misbranding of cigarettes.**

(a) A cigarette will be deemed to be misbranded under section 903(a)(1) of the Federal Food, Drug, and Cosmetic Act if its package does not bear one of the required warnings in accordance with section 4 of the Federal Cigarette Labeling and Advertising Act and this part. A cigarette will be deemed to be misbranded under section 903(a)(7)(A) of the Federal Food, Drug, and Cosmetic Act if its advertising does not bear one of the required warnings in accordance with section 4 of the Federal Cigarette Labeling and Advertising Act and this part.

(b) A cigarette advertisement and other descriptive printed matter issued or caused to be issued by the manufacturer, packer, or distributor will be deemed to include a brief statement of relevant warnings for the purposes of section 903(a)(8) of the Federal Food, Drug, and Cosmetic Act if it bears one of the required warnings in accordance with section 4 of the Federal Cigarette Labeling and Advertising Act and this part. A cigarette distributed or offered for sale in any State shall be deemed to be misbranded under section 903(a)(8) of the Federal Food, Drug, and Cosmetic Act unless the manufacturer, packer, or distributor includes in all advertisements and other descriptive printed matter issued or caused to be issued by the manufacturer, packer, or distributor with respect to the cigarette one of the required warnings in accordance with section 4 of the Federal Cigarette Labeling and Advertising Act and this part.

**PART 1143—MINIMUM REQUIRED WARNING STATEMENTS**

Sec.

1143.1 Definitions.

1143.3 Required warning statement regarding addictiveness of nicotine.

1143.5 Required warning statements for cigars.

1143.7 Language requirements for required warning statements.

1143.9 Irremovable or permanent required warning statements.

1143.11 Does not apply to foreign distribution.

1143.13 Effective date.

AUTHORITY: 21 U.S.C. 387a(b), 387f(d).

SOURCE: 81 FR 29103, May 10, 2016, unless otherwise noted.

**§ 1143.1 Definitions.**

For purposes of this part:

*Accessory* means any product that is intended or reasonably expected to be used with or for the human consumption of a tobacco product; does not contain tobacco and is not made or derived from tobacco; and meets either of the following:

(1) Is not intended or reasonably expected to affect or alter the performance, composition, constituents, or characteristics of a tobacco product; or

(2) Is intended or reasonably expected to affect or maintain the performance, composition, constituents, or characteristics of a tobacco product but

(i) Solely controls moisture and/or temperature of a stored tobacco product; or

(ii) Solely provides an external heat source to initiate but not maintain combustion of a tobacco product

*Cigar* means a tobacco product that:

(1) Is not a cigarette and

(2) Is a roll of tobacco wrapped in leaf tobacco or any substance containing tobacco.

*Cigarette tobacco* means any product that consists of loose tobacco that is intended for use by consumers in a cigarette. Unless otherwise stated, the requirements applicable to cigarettes under this chapter also apply to cigarette tobacco.

*Component or part* means any software or assembly of materials intended or reasonably expected:

(1) To alter or affect the tobacco product's performance, composition, constituents, or characteristics; or

(2) to be used with or for the human consumption of a tobacco product. Component or part excludes anything that is an accessory of a tobacco product.

*Covered tobacco product* means any tobacco product deemed to be subject to the Federal Food, Drug, and Cosmetic Act pursuant to § 1100.2 of this chapter, but excludes any component or part that is not made or derived from tobacco.

*Package or packaging* means a pack, box, carton, or container of any kind or, if no other container, any wrapping (including cellophane), in which a tobacco product is offered for sale, sold, or otherwise distributed to consumers.



*Point of sale* means any location at which a consumer can purchase or otherwise obtain tobacco products for personal consumption.

*Principal display panels* means the panels of a package that are most likely to be displayed, presented, shown, or examined by the consumer.

*Required warning statement* means a textual warning statement required to be on packaging and in advertisements for cigarette tobacco, roll-your-own tobacco, cigars, and other covered tobacco products.

*Retailer* means any person who sells tobacco products to individuals for personal consumption, or who operates a facility where vending machines or self-service displays are permitted under this part.

*Roll-your-own tobacco* means any tobacco product that, because of its appearance, type, packaging, or labeling, is suitable for use and likely to be offered to, or purchased by, consumers as tobacco for making cigarettes.

*Tobacco product.* As stated in section 201(rr) of the Federal Food, Drug, and Cosmetic Act in relevant part, a tobacco product:

(1) Means any product made or derived from tobacco that is intended for human consumption, including any component, part, or accessory of a tobacco product (except for raw materials other than tobacco used in manufacturing a component, part, or accessory of a tobacco product) and

(2) Does not mean an article that is a drug under section 201(g)(1) of the Federal Food, Drug, and Cosmetic Act, a device under section 201(h) of the Federal Food, Drug, and Cosmetic Act, or a combination product described in section 503(g) of the Federal Food, Drug, and Cosmetic Act.

**§ 1143.3 Required warning statement regarding addictiveness of nicotine.**

(a) *Packages.* (1) For cigarette tobacco, roll-your-own tobacco, and covered tobacco products other than cigars, it is unlawful for any person to manufacture, package, sell, offer to sell, distribute, or import for sale or distribution within the United States such product unless the tobacco product package bears the following required warning statement on the pack-

age label: “WARNING: This product contains nicotine. Nicotine is an addictive chemical.”

(2) The required warning statement must appear directly on the package and must be clearly visible underneath any cellophane or other clear wrapping as follows:

(i) Be located in a conspicuous and prominent place on the two principal display panels of the package and the warning area must comprise at least 30 percent of each of the principal display panels;

(ii) Be printed in at least 12-point font size and ensures that the required warning statement occupies the greatest possible proportion of the warning area set aside for the required text;

(iii) Be printed in conspicuous and legible Helvetica bold or Arial bold type (or other sans serif fonts) and in black text on a white background or white text on a black background in a manner that contrasts by typography, layout, or color, with all other printed material on the package;

(iv) Be capitalized and punctuated as indicated in paragraph (a)(1) of this section; and

(v) Be centered in the warning area in which the text is required to be printed and positioned such that the text of the required warning statement and the other information on the principal display panel have the same orientation.

(3) A retailer of any tobacco product covered by paragraphs (a)(1) and (2) of this section will not be in violation of this section for packaging that:

(i) Contains a health warning;

(ii) Is supplied to the retailer by the tobacco product manufacturer, importer, or distributor, who has the required state, local, or Alcohol and Tobacco Tax and Trade Bureau (TTB)-issued license or permit, if applicable, and

(iii) Is not altered by the retailer in a way that is material to the requirements of this section.

(b) *Advertisements.* (1) For cigarette tobacco, roll-your-own tobacco, and covered tobacco products other than cigars, it is unlawful for any such tobacco product manufacturer, packager, importer, distributor, or retailer of the tobacco product to advertise or cause

## § 1143.5

## 21 CFR Ch. I (4–1–20 Edition)

to be advertised within the United States any tobacco product unless each advertisement bears the required warning statement specified in paragraph (a)(1) of this section.

(2) For print advertisements and other advertisements with a visual component (including, for example, advertisements on signs, shelf-talkers, Internet Web pages, and electronic mail correspondence), the required warning statement must appear in the upper portion of the area of the advertisement within the trim area as follows:

(i) Occupy at least 20 percent of the area of the advertisement;

(ii) Appear in at least 12-point font size and ensures that the required warning statement occupies the greatest possible proportion of the warning area set aside for the required text;

(iii) Appear in conspicuous and legible Helvetica bold or Arial bold type (or other similar sans serif fonts) and in black text on a white background or white text on a black background in a manner that contrasts by typography, layout, or color, with all other material on the advertisement;

(iv) Be capitalized and punctuated as indicated in paragraph (a)(1) of this section;

(v) Be centered in the warning area in which the text is required to appear and positioned such that the text of the required warning statement and the other textual information in the advertisement have the same orientation; and

(vi) Be surrounded by a rectangular border that is the same color as the text of the required warning statement and that is not less than 3 millimeters (mm) or more than 4 mm.

(3) This paragraph (b) applies to a retailer only if that retailer is responsible for or directs the health warning required under the paragraph. However, this paragraph does not relieve a retailer of liability if the retailer displays, in a location open to the public, an advertisement that does not contain a health warning or contains a health warning that has been altered by the retailer in a way that is material to the requirements of this section.

(c) *Self-certification.* A tobacco product that would otherwise be required to

bear the warning in paragraph (a)(1) of this section but does not contain nicotine is not required to bear the warning in paragraph (a)(1) of this section on packages or advertisements if the tobacco product manufacturer has submitted to FDA a confirmation statement certifying to be true and accurate that the product does not contain nicotine and that the tobacco product manufacturer has data to support that assertion. Any product not required to bear the warning in paragraph (a)(1) of this section must include the statement “This product is made from tobacco.” on all packages and advertisements in accordance with the requirements of this part.

(d) *Small packages.* A tobacco product that would otherwise be required to bear the warning in paragraph (a)(1) of this section but is too small or otherwise unable to accommodate a label with sufficient space to bear such information is exempt from compliance with the requirement *provided* that the information and specifications required under paragraphs (a)(1) and (2) of this section appear on the carton or other outer container or wrapper if the carton, outer container, or wrapper has sufficient space to bear the information, or appear on a tag otherwise firmly and permanently affixed to the tobacco product package. In such cases, the carton, outer container, wrapper, or tag will serve as the location of the principal display panels.

### § 1143.5 Required warning statements for cigars.

(a) *Packages.* (1) It is unlawful for any person to manufacture, package, sell, offer to sell, distribute, or import for sale or distribution within the United States any cigar product unless the product package bears one of the following required warning statements on the package label:

(i) WARNING: Cigar smoking can cause cancers of the mouth and throat, even if you do not inhale.

(ii) WARNING: Cigar smoking can cause lung cancer and heart disease.

(iii) WARNING: Cigars are not a safe alternative to cigarettes.

(iv) WARNING: Tobacco smoke increases the risk of lung cancer and heart disease, even in nonsmokers.

(v)(A) WARNING: Cigar use while pregnant can harm you and your baby.; or

(B) SURGEON GENERAL WARNING: Tobacco Use Increases the Risk of Infertility, Stillbirth and Low Birth Weight.

(vi) WARNING: This product contains nicotine. Nicotine is an addictive chemical.

(2) Each required warning statement must appear directly on the package and must be clearly visible underneath any cellophane or other clear wrapping as follows:

(i) Be located in a conspicuous and prominent place on the two principal display panels of the package and the warning area must comprise at least 30 percent of each of the principal display panels;

(ii) Appear in at least 12-point font size and ensure that the required warning statement occupies the greatest possible proportion of the warning area set aside for the required text;

(iii) Be printed in conspicuous and legible Helvetica bold or Arial bold type (or other similar sans serif fonts) and in black text on a white background or white text on a black background in a manner that contrasts by typography, layout, or color, with all other printed material on the package;

(iv) Be capitalized and punctuated as indicated in paragraph (a)(1) of this section; and

(v) Be centered in the warning area in which the text is required to be printed and positioned such that the text of the required warning statement and the other information on that principal display panel have the same orientation.

(3) No person may manufacture, package, sell, offer to sell, distribute, or import for sale or distribution within the United States any cigar without a required warning statement, except for cigars that are sold individually and not in a product package. For cigars that are sold individually and not in a product package, the required warning statements must be posted at the retailer's point-of-sale in accordance with the following:

(i) All of the warnings in paragraph (a) of this section must be placed on a sign that is a minimum of 8.5 x 11

inches, posted on or within 3 inches of each cash register where payment may be made so that the sign(s) are unobstructed in their entirety and can be read easily by each consumer making a purchase;

(ii) The sign must be clear, legible, and conspicuous and be printed in black Helvetica bold or Arial bold type (or other similar sans serif fonts) against a solid white background in at least 17 point type with appropriate space between the warning statements;

(iii) Be printed in a manner that contrasts by typography, layout, or color, with all other printed material; and

(iv) Be capitalized and punctuated as indicated in paragraph (a)(1) of this section.

(4) A retailer of any cigar covered by paragraphs (a)(1) and (2) of this section will not be in violation of this section for packaging that:

(i) Contains a health warning;

(ii) Is supplied to the retailer by the tobacco product manufacturer, importer, or distributor who has the required state, local, or Alcohol and Tobacco Tax and Trade Bureau (TTB)-issued license or permit, if applicable, and

(iii) Is not altered by the retailer in a way that is material to the requirements of this section.

(b) *Advertisements.* (1) It is unlawful for any tobacco product manufacturer, packager, importer, distributor, or retailer of cigars to advertise or cause to be advertised within the United States any cigar unless each advertisement bears one of the required warning statements specified in paragraph (a)(1) of this section.

(2) For print advertisements and other advertisements with a visual component (including, for example, advertisements on signs, shelf-talkers, Internet Web pages, and electronic mail correspondence), each required warning statement must appear in the upper portion of the area of the advertisement within the trim area as follows:

(i) Occupy at least 20 percent of the area of the advertisement;

(ii) Appear in at least 12-point font size that ensures that the required

## § 1143.7

## 21 CFR Ch. I (4–1–20 Edition)

warning statement occupies the greatest possible proportion of the warning area set aside for the text required;

(iii) Appear in conspicuous and legible Helvetica bold or Arial bold type (or other similar sans serif fonts) and in black text on a white background or white text on a black background in a manner that contrasts by typography, layout, or color, with all other material on the advertisement;

(iv) Be capitalized and punctuated as indicated in paragraph (a)(1) of this section;

(v) Be centered in the warning area in which the text is required to appear and positioned such that the text of the required warning statement and the other textual information in the advertisement have the same orientation; and

(vi) Be surrounded by a rectangular border that is the same color as the text of the required warning statement and that is not less than 3 mm or more than 4 mm.

(3) This paragraph (b) applies to a retailer only if that retailer is responsible for or directs the warning statements required under the paragraph. However, this paragraph does not relieve a retailer of liability if the retailer displays, in a location open to the public, an advertisement that does not contain a health warning or contains a health warning that has been altered by the retailer in a way that is material to the requirements of this section.

(c) *Marketing requirements.* (1) Except for cigars sold individually and not in a product package, the warning statements required for packages in paragraph (a)(1) of this section must be randomly displayed in each 12-month period, in as equal a number of times as is possible on each brand of cigar sold in product packaging and be randomly distributed in all areas of the United States in which the product is marketed in accordance with a plan submitted by the cigar manufacturer, importer, distributor, or retailer to, and approved by, the Food and Drug Administration.

(2) The warning statements required for advertisements in paragraph (a)(1) of this section must be rotated quarterly in alternating sequence in each

advertisement for each brand of cigar in accordance with a plan submitted by the cigar manufacturer, importer, distributor, or retailer to, and approved by, the Food and Drug Administration.

(3) Each person required to randomly display and distribute or rotate warnings in accordance with an FDA-approved plan under this part shall submit a proposed warning plan to FDA no later than either 12 months after May 10, 2016, or 12 months before advertising or commercially marketing a product that is subject to such requirement, whichever is later.

### § 1143.7 Language requirements for required warning statements.

The text in each warning statement required in § 1143.3 or § 1143.5 must be in the English language, except as follows:

(a) In the case of an advertisement that appears in a non-English medium, the text in the required warning statement must appear in the predominant language of the medium whether or not the advertisement is in English, and;

(b) In the case of an advertisement that appears in an English language medium but that is not in English, the text in the required warning statement must appear in the same language as that principally used in the advertisement.

### § 1143.9 Irremovable or permanent required warning statements.

The warning statements required by this section must be indelibly printed on or permanently affixed to the package or advertisement. These warnings, for example, must not be printed or placed on a product label affixed to a clear outer wrapper that is likely to be removed to access the product within the package.

### § 1143.11 Does not apply to foreign distribution.

The provisions of this part do not apply to a manufacturer or distributor of tobacco products that does not manufacture, package, or import tobacco products for sale or distribution within the United States.

**§ 1143.13 Effective date.**

(a) Except as stated in paragraph (b) of this section, this part will take effect 24 months after May 10, 2016. The effective date will be with respect to the date of manufacture, provided that, in any case, beginning 30 days after the effective date, a manufacturer may not introduce into the domestic commerce of the United States any product, irrespective of the date of manufacture, that is not in conformance with this part.

(b) The requirement to submit a warning plan to FDA under § 1143.5(c)(3) will take effect 12 months after May 10, 2016.

**PART 1150—USER FEES**

## Sec.

- 1150.1 Scope.
- 1150.3 Definitions.
- 1150.5 Required information.
- 1150.7 Yearly class allocation.
- 1150.9 Domestic manufacturer or importer assessment.
- 1150.11 Notification of assessments.
- 1150.13 Payment of assessments.
- 1150.15 Disputes.
- 1150.17 Penalties.

AUTHORITY: 21 U.S.C. 371, 387a, 387b, 387i, 387s, 21 CFR 1100.1.

SOURCE: 79 FR 39310, July 10, 2014, unless otherwise noted.

**§ 1150.1 Scope.**

This part establishes requirements related to tobacco product user fees under section 919 of the Federal Food, Drug, and Cosmetic Act (21 U.S.C. 387s). The total amount of user fees may not exceed the amount specified for that fiscal year in section 919(b) of the Federal Food, Drug, and Cosmetic Act. All domestic manufacturers and importers of tobacco products are required to pay to FDA their percentage share of the total assessment for a fiscal year.

**§ 1150.3 Definitions.**

The following definitions are applicable to this part:

*Class of tobacco products* means each of the following types of tobacco products as defined in 26 U.S.C. 5702 and for which taxes are required to be paid for the removal of such into domestic com-

merce: Cigarettes, cigars, snuff, chewing tobacco, pipe tobacco, and roll-your-own tobacco.

*Domestic manufacturer* means a person who is required to obtain a permit from the Alcohol and Tobacco Tax and Trade Bureau of the Department of the Treasury with respect to the production of tobacco products under title 27 of the Code of Federal Regulations.

*Fiscal year quarter* means a quarter in a fiscal year (the fiscal year is October 1 through September 30). The fiscal year quarters are October 1–December 31, January 1–March 31, April 1–June 30, and July 1–September 30.

*Importer* means a person who is required to obtain a permit from the Alcohol and Tobacco Tax and Trade Bureau of the Department of the Treasury with respect to the importation of tobacco products under title 27 of the Code of Federal Regulations.

*Total assessment* means the total amount of user fees (in dollars) authorized to be assessed and collected for a specific fiscal year under section 919 of the Federal Food, Drug, and Cosmetic Act.

*Units of product* means:

(1) The number of sticks for cigarettes, or

(2) The weight (measured in pounds) for snuff, chewing tobacco, and roll-your-own tobacco.

*Units of product* means:

(1) The number of sticks for cigarettes and cigars, or

(2) The weight (measured in pounds) for snuff, chewing tobacco, pipe tobacco, and roll-your-own tobacco.

*Yearly class allocation* means the amount of user fees (in dollars) assessed for a class of tobacco products for a particular fiscal year.

[79 FR 39310, July 10, 2014, as amended at 81 FR 28715, May 10, 2016]

**§ 1150.5 Required information.**

(a) *General.* Each domestic manufacturer and importer of tobacco products that are part of a class of tobacco products must submit the information described in this section for such products each month, and the information must be received by FDA no later than the 20th day of each month. The information must be submitted using the

## § 1150.7

## 21 CFR Ch. I (4–1–20 Edition)

form that FDA provides. The information must be submitted even if the domestic manufacturer or importer had no removals subject to tax during the prior month. FDA will use the information submitted under this section and any other available information, as FDA determines appropriate, to make tobacco product user fee assessments.

(b) *Contents.* Each domestic manufacturer and importer must submit the following:

(1) *Identification information.* (i) Its name and the mailing address of its principal place of business;

(ii) The name and a telephone number including area code of an office or individual that FDA may contact for further information;

(iii) The email address and postal address at which it wishes to receive notifications FDA sends under this part;

(iv) The Alcohol and Tobacco Tax and Trade Bureau (TTB) Permit Number(s); and

(v) The Employer Identification Number(s) (EIN).

(2) *Removal information.* The units of product, by class, removed and not tax exempt for the prior month and the Federal excise tax it paid, by class, for such removal.

(i) This information must be reported for each TTB tobacco permit.

(ii) If the domestic manufacturer or importer did not remove any amount of tobacco product, it must report that no tobacco product was removed into domestic commerce.

(3) *Certified copies.* Certified copies of the returns and forms that relate to:

(i) The removal of tobacco products into domestic commerce (as defined by section 5702 of the Internal Revenue Code of 1986); and

(ii) The payment of the Federal excise taxes imposed under chapter 52 of the Internal Revenue Code of 1986.

(c) *First report for cigars.* Domestic manufacturers and importers of cigars must submit the information described in this section beginning no later than the 20th day of August, 2016. Domestic manufacturers and importers of cigars must submit the information described in this section for each of the prior months of fiscal year 2016 as their first monthly submission. The previous sen-

tence only applies for the first report in fiscal year 2016.

(d) *First report for pipe tobacco.* Domestic manufacturers and importers of pipe tobacco must submit the information described in this section beginning no later than the 20th day of August, 2016.

[79 FR 39310, July 10, 2014, as amended at 81 FR 28715, May 10, 2016]

### § 1150.7 Yearly class allocation.

For each fiscal year, FDA will allocate the total assessment among the classes of tobacco products.

(a) *Calculation.* FDA will calculate the percentage shares for each class as follows:

(1) Except for cigars, FDA will multiply the units of product removed and not tax exempt for the most recent full calendar year by the 2003 maximum Federal excise tax rate for that class (class dollar figure).

(2) For cigars, FDA will:

(i) Multiply the units of small cigars removed and not tax exempt for the most recent full calendar year by the 2003 maximum Federal excise tax rate for small cigars (small cigar subclass dollar figure).

(ii) Multiply the units of large cigars removed and not tax exempt for the most recent full calendar year by the 2003 maximum Federal excise tax rate for large cigars (large cigar subclass dollar figure).

(iii) Add the small cigar subclass dollar figure and the large cigar subclass dollar figure (cigar class dollar figure).

(3) FDA will total the class dollar figures for all tobacco classes for the most recent full calendar year (total dollar figure).

(4) FDA will divide the class dollar figure by the total dollar figure to determine the percentage share for each class.

(5) FDA will calculate the allocation for each class of tobacco products by multiplying the percentage share for each class by the total assessment.

(b) *Reallocation.* For any class of tobacco products that is not deemed by FDA to be subject to regulation under chapter IX of the Federal Food, Drug, and Cosmetic Act, the amount of user fees that would otherwise be assessed to such class of tobacco products will

be reallocated to the classes of tobacco products that are subject to chapter IX of the Federal Food, Drug, and Cosmetic Act in the same manner and based on the same relative percentages otherwise determined under paragraph (a) of this section.

[79 FR 39310, July 10, 2014, as amended at 81 FR 28716, May 10, 2016]

**§ 1150.9 Domestic manufacturer or importer assessment.**

Each quarter, FDA will calculate the assessment owed by each domestic manufacturer or importer for that quarter.

(a) *Calculation.* (1) For each class of tobacco products except cigars, FDA will calculate the percentage share for each domestic manufacturer and importer by dividing the Federal excise taxes that it paid for the class for the prior quarter by the total excise taxes that all domestic manufacturers and importers paid for the class for that same quarter.

(2) For the cigar class, FDA will calculate the percentage share for each domestic manufacturer and importer by dividing the Federal excise taxes that it paid for the class for the prior fiscal year by the total excise taxes that all domestic manufacturers and importers paid for the class for the prior fiscal year.

(3) If the percentage share calculated for a domestic manufacturer or importer in this section, as applicable, is less than 0.0001 percent, the share is excluded from the assessment for that class of tobacco products.

(4) Within each class of tobacco products, the assessment owed by a domestic manufacturer or importer for the quarter is the yearly class allocation, determined as described in §1150.7, divided by four, multiplied by the domestic manufacturer's or importer's percentage share, truncated to the fourth decimal place, for that class of tobacco products.

(b) *Adjustments.* Annually, FDA will make any necessary adjustments to individual domestic manufacturer or importer assessments if needed to account for any corrections (for example, to include domestic manufacturers or

importers that were not included in a relevant assessment calculation).

[79 FR 39310, July 10, 2014, as amended at 81 FR 28716, May 10, 2016]

**§ 1150.11 Notification of assessments.**

(a) *Notification.* No later than 30 calendar days before the end of each fiscal year quarter, FDA will notify each domestic manufacturer and importer of the amount of the quarterly assessment imposed on the domestic manufacturer or importer.

(b) *Content of notification.* The notification under paragraph (a) of this section will include the following:

(1) The amount of the quarterly assessment imposed on the domestic manufacturer or importer and the date that payment of the assessment must be received by FDA;

(2) Class assessment information, including each class' initial percentage share, the reallocation amount (if any) and each class' percentage share after any such reallocation, and the quarterly assessment for each class;

(3) Domestic manufacturer or importer assessment information, including the domestic manufacturer's or importer's percentage share of each relevant class of tobacco products and invoice amount;

(4) Any adjustments FDA has made under §1150.9(b);

(5) The manner in which assessments are to be remitted to FDA;

(6) Information about the accrual of interest if a payment is late; and

(7) Information regarding where to send a dispute and when it needs to be sent.

**§ 1150.13 Payment of assessments.**

(a) Payment of an assessment must be received by FDA no later than the last day of each fiscal year quarter.

(b) Payments must be submitted to FDA in U.S. dollars and in the manner specified in the notification.

(c) Except as provided in paragraph (d) of this section, if an assessment is not received by the last day of the fiscal year quarter, FDA will begin assessing interest on the unpaid amount in accordance with 31 U.S.C. 3717.

(d) If FDA does not send the notification described in §1150.11(a) 30 calendar

**§ 1150.15**

**21 CFR Ch. I (4–1–20 Edition)**

days before the end of a quarter, no interest will be assessed by FDA under paragraph (c) of this section until 30 calendar days have elapsed from the date FDA sent notification of the amount owed.

(e) If a domestic manufacturer or importer disputes the amount of an assessment, it must still pay the assessment in accordance with paragraphs (a) and (b) of this section.

**§ 1150.15 Disputes.**

(a) A domestic tobacco manufacturer or importer may dispute an FDA assessment. The dispute must include the basis for the dispute, and the dispute must be:

- (1) Submitted in writing;
- (2) Received by FDA no later than 45 days after the date on the assessment notification;
- (3) Legible and in English; and
- (4) Sent to the address found on our Web site (<http://www.fda.gov/tobaccoproducts>).

(b) If FDA determines that there was an error related to the assessment and the assessment was too high, FDA will refund the amount assessed in error to the domestic manufacturer or importer.

(c) FDA will provide a dated, written response, and its response will provide information about how to submit a request for further Agency review.

(d) A request for further Agency review under §10.75 of this chapter may be submitted. Such a request must be

submitted in writing by the domestic manufacturer or importer and received by FDA within 30 days from the date on FDA's response. The request for further Agency review must be legible, in English, and submitted to the address found on our Web site (<http://www.fda.gov/tobaccoproducts>).

**§ 1150.17 Penalties.**

(a) Under section 902(4) of the Federal Food, Drug, and Cosmetic Act (21 U.S.C. 387b), a tobacco product is deemed adulterated if the domestic manufacturer or importer of the tobacco product fails to pay a user fee assessed to such manufacturer or importer by the later of the date the assessment is due, 30 days from the date FDA sent notification of the amount owed, or 30 days after final Agency action on a resolution of any dispute as to the amount of the fee.

(b) Under section 902(4) of the Federal Food, Drug, and Cosmetic Act, a tobacco product is deemed adulterated if the domestic manufacturer or importer of the tobacco product fails to report the information required by §1150.5 to calculate assessments under this part.

(c) The failure to report the information required by §1150.5 to calculate assessments under this part is a prohibited act under section 301(e) of the Federal Food, Drug, and Cosmetic Act.

(d) Information submitted under §1150.5 is subject to 18 U.S.C. 1001 and other appropriate civil and criminal statutes.



## SUBCHAPTER L—REGULATIONS UNDER CERTAIN OTHER ACTS ADMINISTERED BY THE FOOD AND DRUG ADMINISTRATION

### PART 1210—REGULATIONS UNDER THE FEDERAL IMPORT MILK ACT

#### Subpart A—General Provisions

Sec.

- 1210.1 Authority.
- 1210.2 Scope of act.
- 1210.3 Definitions.

#### Subpart B—Inspection and Testing

- 1210.10 Availability for examination and inspection.
- 1210.11 Sanitary inspection of dairy farms.
- 1210.12 Physical examination of cows.
- 1210.13 Tuberculin test.
- 1210.14 Sanitary inspection of plants.
- 1210.15 Pasteurization; equipment and methods.
- 1210.16 Method of bacterial count.
- 1210.17 Authority to sample and inspect.
- 1210.18 Scoring.

#### Subpart C—Permit Control

- 1210.20 Application for permit.
- 1210.21 Permit number.
- 1210.22 Form of tag.
- 1210.23 Permits granted on certificates.
- 1210.24 Temporary permits.
- 1210.25 Permits for pasteurized milk or cream.
- 1210.26 Permits for raw milk or cream.
- 1210.27 Permits waiving clauses 2 and 5, section 2 of the Federal Import Milk Act.
- 1210.28 Permits waiving clause 4, section 2 of the Federal Import Milk Act.

#### Subpart D—Hearings

- 1210.30 Hearing procedure for permit denial, suspension, and revocation.
- 1210.31 Hearing before prosecution.

AUTHORITY: 21 U.S.C. 141-149.

SOURCE: 38 FR 32104, Nov. 20, 1973, unless otherwise noted.

CROSS REFERENCES: For Animal and Plant Health Inspection Service regulations concerning tubercular cattle, see 9 CFR parts 50 and 77. For Animal and Plant Health Inspection Service regulations, see 9 CFR chapter I. For customs regulations concerning importation of milk and cream, see 19 CFR 12.7. For regulations of the Agricultural Marketing Service (Marketing Agreements and Orders) covering marketing areas for milk, see 7 CFR chapter X.

### Subpart A—General Provisions

#### § 1210.1 Authority.

For the purposes of the regulations in this part the act (44 Stat. 1101; 21 U.S.C. 141-149) "To regulate the importation of milk and cream into the United States for the purpose of promoting the dairy industry of the United States and protecting the public health" shall be known and referred to as "the Federal Import Milk Act."

#### § 1210.2 Scope of act.

The provisions of the act apply to all milk and cream offered for import into the continental United States.

#### § 1210.3 Definitions.

(a) *Secretary*. Secretary means the Secretary of Health and Human Services.

(b) *Commissioner*. Commissioner means the Commissioner of Food and Drugs.

(c) *Milk*. For the purposes of the act and of the regulations in this part:

Milk is the whole, fresh, clean, lacteal secretion obtained by the complete milking of one or more healthy cows, properly fed and kept, excluding that obtained within 15 days before and 5 days after calving, or such longer period as may be necessary to render the milk practically colostrum free.

(d) *Condensed milk*. Condensed milk, as the term is used in section 3, paragraph 2, of the Federal Import Milk Act, includes evaporated milk in the manufacture of which sterilization of the milk and cream is a necessary and usual process; it includes sweetened condensed milk only if it is prepared by a process which insures sterilization of the milk and cream. Condensed milk, as the term is used in section 3, paragraph 3, of the Federal Import Milk Act, means sweetened condensed milk.

(e) *Sweetened condensed milk*. Sweetened condensed milk conforms to the definition and standard of identity for

## § 1210.10

such food as set out in §131.120 of this chapter.

(f) *Evaporated milk.* Evaporated milk conforms to the definition and standard of identity for such food as set out in §131.130 of this chapter.

(g) *Cream.* Cream is that portion of the milk, rich in milk fat, which rises to the surface of milk on standing or is separated from it by centrifugal force. (See §§131.150 through 131.157 of this chapter).

(h) *Pasteurization.* Pasteurization is the process of heating every particle of milk or cream to at least 143 °F., and holding it at such temperature continuously for at least 30 minutes, or to at least 161 °F., and holding it at such temperature continuously for at least 15 seconds.

(i) *Shipper.* A shipper is anyone, other than a common carrier, who ships, transports, or causes to be shipped or transported into the United States milk or cream owned by him.

[38 FR 32104, Nov. 20, 1973, as amended at 42 FR 14091, Mar. 15, 1977]

## Subpart B—Inspection and Testing

### § 1210.10 Availability for examination and inspection.

Dairy farms and plants from which milk or cream is shipped or transported into the United States shall be open at all reasonable times to authorized agents for necessary examinations and inspections. Failure to permit such examinations and inspections may be considered cause for the suspension or revocation of the permit.

### § 1210.11 Sanitary inspection of dairy farms.

The sanitary conditions of any dairy farm producing milk or cream to be shipped or transported into the United States or to a plant from which milk or cream is to be shipped or transported into the United States must score at least 50 points out of 100 points, according to the methods for scoring as provided by the score card for sanitary inspection of dairy farms in the form prescribed by the Secretary.

## 21 CFR Ch. I (4–1–20 Edition)

### § 1210.12 Physical examination of cows.

(a) Physical examination of any and all cows in herds producing milk or cream which is to be shipped or transported into the United States shall be made by an authorized veterinarian of the United States or of any State or municipality thereof or of the country in which such milk or cream is produced to determine whether such cow or cows are in a healthy condition. Such examination shall be made as often as the Secretary may deem necessary and, in any event, shall have been made within one year previous to the time of the importation.

(b) The result of the physical examination shall be set forth in the form prescribed by the Secretary.

### § 1210.13 Tuberculin test.

(a) Except as provided in §1210.27 any and all animals in herds producing milk or cream which is to be shipped or transported raw into the United States shall be free from tuberculosis, as determined by a tuberculin test applied by an official veterinarian of the United States or of any State or municipality thereof or of the country in which such milk or cream is produced. Such test shall be made as often as the Secretary may deem necessary and, in any event, shall have been made within 1 year previous to the time of the importation. All animals showing positive or suspicious reactions to the tuberculin test must be permanently removed from the herd.

(b) The results of the tuberculin test and all facts concerning the disposal of reacting or suspected animals shall be set forth in the form prescribed by the Secretary.

### § 1210.14 Sanitary inspection of plants.

The sanitary conditions of any plant handling milk or cream any part of which is to be shipped or transported into the United States shall score at least 50 points out of 100 points according to the methods for scoring as provided by the score card for sanitary inspection of such plants in the form prescribed by the Secretary.

**Food and Drug Administration, HHS**

**§ 1210.23**

**§ 1210.15 Pasteurization; equipment and methods.**

All dairy farms and plants at which any milk or cream is pasteurized for shipment or transportation into the United States shall employ adequate pasteurization machinery of a type easily cleaned and of sanitary construction capable of holding every portion of the milk or cream at the required temperature for the required time. Such pasteurizing machinery shall be properly equipped with accurate time and temperature recording devices, which shall be kept at all times in good working order. The temperature at the time of heating and holding must invariably be recorded on thermograph charts, initialed, numbered, and dated by the official having jurisdiction over such farms and plants. All thermograph charts shall be held for a period of 2 years unless within that period they have been examined and released by such authorized agents as are designated by the Secretary.

**§ 1210.16 Method of bacterial count.**

The bacterial count of milk and cream refers to the number of viable bacteria as determined by the standard plate method of the American Public Health Association in use at the time of the examination.

**§ 1210.17 Authority to sample and inspect.**

Inspectors engaged in the enforcement of the Federal Import Milk Act are empowered to test for temperature, to take samples of milk or cream, and to use such means as may be necessary for these purposes.

**§ 1210.18 Scoring.**

Scoring of sanitary conditions required by §§ 1210.11, 1210.14 shall be done by an official inspector of the United States or of any State or municipality thereof or of the country in which the dairy farm or plant is located.

**Subpart C—Permit Control**

**§ 1210.20 Application for permit.**

Application for a permit to ship or transport milk or cream into the United States shall be made by the ac-

tual shipper upon forms prescribed by the Secretary. The request for forms of applications for permits should be addressed to Commissioner of Food and Drugs, Food and Drug Administration, Department of Health and Human Services, 5600 Fishers Lane, Rockville, MD 20857.

**§ 1210.21 Permit number.**

Each permit issued under the Federal Import Milk Act, including each temporary permit, shall bear an individual number. The right to the use of such number is restricted solely to the permittee.

**§ 1210.22 Form of tag.**

Each container of milk or cream shipped or transported into the United States by such permittee shall have firmly attached thereto a tag in the following form, bearing the required information in clear and legible type:

Product \_\_\_\_\_  
(State whether raw milk, pasteurized milk, raw cream, or pasteurized cream.)  
Permit number \_\_\_\_\_  
Federal Import Milk Act, Department of Health and Human Services.  
Shipper \_\_\_\_\_  
Address of shipper \_\_\_\_\_

*Provided*, That in case of unit shipments consisting of milk only or cream only under one permit number, in lieu of each container being so marked, the vehicle of transportation, if sealed, may be tagged with the above tag, which should, in addition, show the number of containers and quantity of contents of each.

**§ 1210.23 Permits granted on certificates.**

In the discretion of the Secretary, a permit may be granted on a duly certified statement signed by a duly accredited official of an authorized department of any foreign government or of any State of the United States or any municipality thereof. Such statement shall be in the form of a certificate prescribed by the Secretary, and shall have attached thereto, as a part thereof, signed copies of reports prescribed by §§ 1210.12, 1230.13, and also by §§ 1210.11, 1210.14, as applicable. The necessary inspections and examinations upon which the reports are based

## § 1210.24

shall be made by persons who are acting under the direct supervision of the certifying official.

### § 1210.24 Temporary permits.

A temporary permit will be granted only upon a satisfactory showing that the applicant therefor has been unable to obtain the necessary inspections required by the applicable provisions of section 2 of the Federal Import Milk Act. Temporary permits shall be valid until the Secretary shall provide for inspection to ascertain that clauses 1, 2, and 3 of section 2 of the Federal Import Milk Act have been complied with.

### § 1210.25 Permits for pasteurized milk or cream.

Permits to ship or transport pasteurized milk or cream into the United States will be granted only upon compliance with the requirements of clauses 1 and 3 of section 2 of the Federal Import Milk Act, §§ 1210.11, 1210.12, 1210.14, as applicable.

### § 1210.26 Permits for raw milk or cream.

Except as provided in § 1210.27, permits to ship or transport raw milk or cream into the United States will be granted only when the milk or cream comes from dairy farms or plants where pasteurization is not carried on and then only upon compliance with the requirements of clauses 1, 2, and 3 of section 2 of the Federal Import Milk Act, §§ 1210.11 to 1210.14 as applicable.

### § 1210.27 Permits waiving clauses 2 and 5, section 2 of the Federal Import Milk Act.

A permit to ship or transport raw milk into the United States will contain a waiver of clauses 2 and 5 of section 2 of the Federal Import Milk Act when the shipper is an operator of a creamery or condensery, or is a producer shipping or transporting to a creamery or condensery and the creamery or condensery is located in the United States within a radius of 20 miles of the point of production of such milk, and the milk, prior to its sale, use, or disposal, is pasteurized, condensed, or evaporated.

## 21 CFR Ch. I (4-1-20 Edition)

### § 1210.28 Permits waiving clause 4, section 2 of the Federal Import Milk Act.

The Secretary, in his discretion, will issue to a shipper who is an operator of a condensery a permit waiving the requirements of clause 4, of section 2 of the Federal Import Milk Act and allowing milk and cream containing not to exceed 1,200,000 bacteria per cubic centimeter to be shipped or transported into the United States if the condensery is located within a radius of 15 miles of the point of production of the milk and cream and such milk and cream are to be sterilized in the manufacture of condensed milk.

## Subpart D—Hearings

### § 1210.30 Hearing procedure for permit denial, suspension, and revocation.

Any person who contests denial, suspension, or revocation of a permit shall have an opportunity for a regulatory hearing before the Food and Drug Administration pursuant to subpart F of part 16 of this chapter.

[41 FR 48269, Nov. 2, 1976, as amended at 42 FR 15676, Mar. 22, 1977]

### § 1210.31 Hearing before prosecution.

Before violation of the act is referred to the Department of Justice for prosecution under section 5 of the Federal Import Milk Act, an opportunity to be heard will be given to the party against whom prosecution is under consideration. The hearing will be private and confined to questions of fact. The party notified may present evidence, either oral or written, in person or by attorney, to show cause why he should not be prosecuted. After a hearing is held, if it appears that the law has been violated, the facts will be reported to the Department of Justice.

[41 FR 48269, Nov. 2, 1976]

## PART 1230—REGULATIONS UNDER THE FEDERAL CAUSTIC POISON ACT

### Subpart A—General Provisions

Sec.  
1230.2 Scope of the act.  
1230.3 Definitions.

**Subpart B—Labeling**

- 1230.10 Placement.
- 1230.11 Required wording.
- 1230.12 Manufacturer; distributor.
- 1230.13 Labeling of “poison”.
- 1230.14 Directions for treatment.
- 1230.15 Responsibility for labeling directions for treatment.
- 1230.16 Exemption from labeling directions for treatment.

**Subpart C—Guaranty**

- 1230.20 General guaranty.
- 1230.21 Specific guaranty.

**Subpart D—Administrative Procedures**

- 1230.30 Collection of samples.
- 1230.31 Where samples may be collected.
- 1230.32 Analyzing of samples.
- 1230.33 Investigations.
- 1230.34 Analysis.
- 1230.35 Hearings.
- 1230.36 Hearings; when not provided for.
- 1230.37 Publication.

**Subpart E—Imports**

- 1230.40 Required label information.
- 1230.41 Delivery of containers.
- 1230.42 Invoices.
- 1230.43 Enforcement.
- 1230.44 Samples.
- 1230.45 No violation; release.
- 1230.46 Violation.
- 1230.47 Rejected containers.
- 1230.48 Relabeling of containers.
- 1230.49 Penalties.

AUTHORITY: 15 U.S.C. 1261–1276.

CROSS REFERENCES: For regulations relating to invoices, entry, and assessment of duties, see 19 CFR parts 141, 142, 143, 151, 152. For regulations regarding the examination, classification, and disposition of foods, drugs, devices, cosmetics, insecticides, fungicides, and caustic or corrosive substances, see 19 CFR part 12. For regulations relating to consular invoices, and documentation of merchandise, see 22 CFR parts 91 and 92.

SOURCE: 38 FR 32110, Nov. 20, 1973, unless otherwise noted.

**Subpart A—General Provisions****§ 1230.2 Scope of the act.**

The provisions of the act apply to any container which has been shipped or delivered for shipment in interstate or foreign commerce, as defined in section 2(c) of the act (44 Stat. 1407; 15 U.S.C. 402) or which has been received

from shipment in such commerce for sale or exchange, or which is sold or offered for sale or held for sale or exchange in any Territory or possession or in the District of Columbia.

**§ 1230.3 Definitions.**

(a) The word *container* as used in the regulations in this part means a retail parcel, package, or container suitable for household use and employed exclusively to hold any dangerous caustic or corrosive substance defined in the act.

(b) The words *suitable for household use* mean and imply adaptability for ready or convenient handling in places where people dwell.

**Subpart B—Labeling****§ 1230.10 Placement.**

The label or sticker shall be so firmly attached to the container that it will remain thereon while the container is being used, and be so placed as readily to attract attention.

**§ 1230.11 Required wording.**

(a) The common name of the dangerous caustic or corrosive substance which shall appear on the label or sticker is the name given in section 2(a) of the act (44 Stat. 1406; 15 U.S.C. 402) or any other name commonly employed to designate and identify such substance.

(b) Preparations within the scope of the act bearing trade or fanciful names shall, in addition, be labeled with the common name of the dangerous caustic or corrosive substance contained therein and comply with all the other requirements of the act and of the regulations in this part.

**§ 1230.12 Manufacturer; distributor.**

If the name on the label or sticker is other than that of the manufacturer, it shall be qualified by such words as “packed for,” “packed by,” “sold by,” or “distributed by,” as the case may be, or by other appropriate expression.

**§ 1230.13 Labeling of “poison”.**

The following are styles of uncondensed Gothic capital letters 24-point (type face) size:

# POISON POISON

When letters of not less than 24-point size are required on a label in stating the word "poison" they must not be smaller than those above set forth.

## § 1230.14 Directions for treatment.

Except as provided in §1230.16, the container shall bear in all cases upon the label or sticker thereof, immediately following the word "Poison," directions for treatment in the case of internal personal injury; in addition, if the substance may cause external injury, directions for appropriate treatment shall be given. The directions shall prescribe such treatments for personal injury as are sanctioned by competent medical authority, and the materials called for by such directions shall be, whenever practicable, such as are usually available in the household.

## § 1230.15 Responsibility for labeling directions for treatment.

A person who receives from a manufacturer or wholesaler any container which under the conditions set forth in section 2(b)(4) of the act and §1230.16 does not bear at the time of shipment directions for treatment in the case of personal injury must place such directions on the label or sticker if he offers such container for general sale or exchange.

## § 1230.16 Exemption from labeling directions for treatment.

Manufacturers and wholesalers only, at the time of shipment or delivery for shipment, are exempted from placing directions for treatment on the label or sticker of any container for other than household use, but in any event the information required by section 2(b) (1), (2), and (3) of the act (44 Stat. 1407; 15 U.S.C. 402) and the regulations in this part shall be given.

## Subpart C—Guaranty

### § 1230.20 General guaranty.

In lieu of a particular guaranty for each lot of dangerous caustic or corrosive substances, a general continuing guaranty may be furnished by the guarantor to actual or prospective purchasers. The following are forms of continuing guaranties:

(a) Substances for both household use and other than household use:

The undersigned guarantees that the retail parcels, packages, or containers of the dangerous caustic or corrosive substance or substances to be sold to \_\_\_\_\_ are not misbranded within the meaning of the Federal Caustic Poison Act.

(Date)

(Signature and address of guarantor)

(b) Substances for other than household use (this form may be issued only by a manufacturer or wholesaler) (§§ 1230.15, 1230.16):

The dangerous caustic or corrosive substance or substances in retail parcels, packages, or containers suitable for household use to be sold to \_\_\_\_\_ are for other than household use, and guaranteed not to be misbranded within the meaning of the Federal Caustic Poison Act.

(Date)

(Signature and address of manufacturer or wholesaler)

### § 1230.21 Specific guaranty.

If a guaranty in respect to any specific lot of dangerous caustic or corrosive substances be given, it shall be incorporated in or attached to the bill of sale, invoice, or other schedule bearing the date and the name and quantity of the substance sold, and shall not appear on the label or package. The following are forms of specific guaranties:

(a) Substances for both household use and other than household use:

The undersigned guarantees that the retail parcels, packages, or containers of the dangerous caustic or corrosive substance or substances listed herein (or specifying the substances) are not misbranded within the meaning of the Federal Caustic Poison Act.

(Signature and address of guarantor)

(b) Substances for other than household use (this form may be issued only by a manufacturer or wholesaler (§§ 1230.15, 1230.16):

The dangerous caustic or corrosive substance or substances listed herein (or specifying the substances) in retail parcels, packages, or containers suitable for household use are for other than household use and are guaranteed not to be misbranded within the meaning of the Federal Caustic Poison Act.

(Name and address of manufacturer or wholesaler)

### Subpart D—Administrative Procedures

#### § 1230.30 Collection of samples.

Samples for examination by or under the direction and supervision of the Food and Drug Administration shall be collected by:

(a) An authorized agent in the employ of the Department of Health and Human Services;

(b) Any officer of any State, Territory, or possession, or of the District of Columbia, authorized by the Secretary of Health and Human Services.

#### § 1230.31 Where samples may be collected.

Caustic or corrosive substances within the scope of this act (44 Stat. 1406; 15 U.S.C. 401–411) may be sampled wherever found.

#### § 1230.32 Analyzing of samples.

Samples collected by an authorized agent shall be analyzed at the laboratory designated by the Food and Drug Administration. Only such samples as are collected in accordance with §§ 1230.30, 1230.31 may be analyzed by or under the direction and supervision of the Food and Drug Administration. Upon request one subdivision of the sample, if available, shall be delivered to the party or parties interested.

#### § 1230.33 Investigations.

Authorized agents in the employ of the Department of Health and Human Services may make investigations, including the inspection of premises where dangerous caustic and corrosive substances subject to the act are manufactured, packed, stored, or held for sale or distribution, and make examinations of freight and other transportation records.

#### § 1230.34 Analysis.

(a) The methods of examination or analysis employed shall be those prescribed by the Association of Official Agricultural Chemists, when applicable, provided, however, that any method of analysis or examination satisfactory to the Food and Drug Administration may be employed.

(b) All percentages stated in the definitions in section 2(a) of the Federal Caustic Poison Act shall be determined by weight.

#### § 1230.35 Hearings.

Whenever it appears from the inspection, analysis, or test of any container that the provisions of section 3 or 6 of the Federal Caustic Poison Act (44 Stat. 1407, 1409; 15 U.S.C. 403, 406) have been violated and criminal proceedings are contemplated, notice shall be given to the party or parties against whom prosecution is under consideration and to other interested parties, and a date shall be fixed at which such party or parties may be heard. The hearing shall be held at the office of the Food and Drug Administration designated in the notice and shall be private and confined to questions of fact. The parties notified may present evidence, either oral or written, in person or by attorney, to show cause why the matter should not be referred for prosecution as a violation of the Federal Caustic Poison Act.

#### § 1230.36 Hearings; when not provided for.

No hearing is provided for when the health, medical, or drug officer or agent of any State, Territory, or possession, or of the District of Columbia, acts under the authority contained in section 8 of the Federal Caustic Poison

### § 1230.37

Act (44 Stat. 1409; 15 U.S.C. 408) in reporting a violation direct to the United States attorney.

### § 1230.37 Publication.

(a) After judgment of the court in any proceeding under the Federal Caustic Poison Act, notice shall be given by publication. Such notice shall include the findings of the court and may include the findings of the analyst and such explanatory statements of fact as the Secretary of Health and Human Services may deem appropriate.

(b) This publication may be made in the form of a circular, notice, or bulletin, as the Secretary of Health and Human Services may direct.

(c) If an appeal be taken from the judgment of the court before such publication, that fact shall appear.

## Subpart E—Imports

### § 1230.40 Required label information.

Containers which are offered for import shall in all cases bear labels or stickers having thereon the information required by section 2(b) (1), (2), and (3) of the Federal Caustic Poison Act and the directions for treatment in the case of personal injury, except such directions need not appear on the label or sticker at the time of shipment by a wholesaler or manufacturer for other than household use.

### § 1230.41 Delivery of containers.

Containers shall not be delivered to the consignee prior to report of examination, unless a bond has been given on the appropriate form for the amount of the full invoice value of such containers, together with the duty thereon, and the refusal of the consignee to return such containers for any cause to the custody of the District Director of Customs when demanded, for the purpose of excluding them from the country or for any other purpose, the consignee shall pay an amount equal to the sum named in the bond, and such part of the duty, if any, as may be payable, as liquidated damages for failure to return to the District Director of Customs on demand all containers covered by the bond.

## 21 CFR Ch. I (4–1–20 Edition)

### § 1230.42 Invoices.

As soon as the importer makes entry, the invoices covering containers and the public stores packages shall be made available, with the least possible delay, for inspection by the representative of the district. When no sample is desired the invoice shall be stamped by the district “No sample desired, Food and Drug Administration, Department of Health and Human Services, per (initials of inspecting officer).”

### § 1230.43 Enforcement.

(a) *Enforcement agency.* The Federal Caustic Poison Act shall be enforced by the Food and Drug Administration, Department of Health and Human Services.

(b) *Enforcement of provisions.* The enforcement of the provisions of the Federal Caustic Poison Act as they relate to imported dangerous caustic or corrosive substances, will, as a general rule, be under the direction of the chief of the local inspection district of the Food and Drug Administration, Department of Health and Human Services, and District Directors of Customs acting as administrative officers in carrying out directions relative to the detention, exportation, and sale, or other disposition of such substances and action under the bond in case of noncompliance with the provisions of the Federal Caustic Poison Act.

(c) *Chief of district as customs officer.* The chief of district shall be deemed a customs officer in enforcing import regulations.

(d) *Nonlaboratory ports.* (1) At the ports of entry where there is no district of the Food and Drug Administration, the District Director of Customs or deputy, on the day when the first notice of expected shipment of containers is received, either by invoice or entry, shall notify the chief of district in whose territory the port is located.

(2) On the day of receipt of such notice the chief of district shall mail to the District Director of Customs appropriate notice, if no sample is desired. This notice serves as an equivalent to stamping the invoices at district ports with the legend “No sample desired,



## Food and Drug Administration, HHS

## § 1230.48

Food and Drug Administration, Department of Health and Human Services, per (initials of inspecting officer).”

(3) If samples are desired, the Chief of district shall immediately notify the District Director of Customs.

(4) The District Director of Customs at once shall forward samples, accompanied by description of shipment.

(5) When samples are desired from each shipment of containers, the chief of district shall furnish to District Director of Customs and deputies at ports within the district's territory a list of such containers, indicating the size of sample necessary. Samples should then be sent promptly on arrival of containers without awaiting special request.

(6) In all other particulars the procedure shall be the same at nonlaboratory ports as at laboratory ports, except that the time consumed in delivery of notices by mail shall be allowed for.

### § 1230.44 Samples.

On the same day that samples are requested by the district, the District Director of Customs or appraiser shall notify the importer that samples will be taken, that the containers must be held intact pending a notice of the result of inspection and analysis, and that in case the containers do not comply with the requirements of the Federal Caustic Poison Act, they must be returned to the District Director of Customs for disposition. This notification may be given by the District Director of Customs or appraiser through individual notices to the importer or by suitable bulletin notices posted daily in the customhouse.

### § 1230.45 No violation; release.

As soon as examination of the samples is completed, if no violation of the act is detected, the chief of the district shall send a notice of release to the importer and a copy of this notice to the District Director of Customs for his information.

### § 1230.46 Violation.

(a) If a violation of the Federal Caustic Poison Act is disclosed, the chief of the district shall send to the importer

due notice of the nature of the violation and of the time and place where evidence may be presented, showing that the containers should not be refused admission. At the same time similar notice regarding detention of the containers shall be sent to the District Director of Customs, requesting him to refuse delivery thereof or to require their return to customs custody if by any chance the containers were released without the bond referred to in §1230.41. The time allowed the importer for representations regarding the shipment may be extended at his request for a reasonable period to permit him to secure such evidence.

(b) If the importer does not reply to the notice of hearing in person or by letter within the time allowed on the notice, a second notice, marked “second and last notice,” shall be sent at once by the chief of the district, advising him that failure to reply will cause definite recommendation to the District Director of Customs that the containers be refused admission and that the containers be exported within 3 months under customs supervision.

### § 1230.47 Rejected containers.

(a) In all cases where the containers are to be refused admission, the chief of the district within 1 day after hearing, or, if the importer does not appear or reply within 3 days after second notice, shall notify the District Director of Customs in duplicate accordingly.

(b) Not later than 1 day after receipt of this notice the District Director of Customs shall sign and transmit to the importer one of the copies, which shall serve as notification to the importer that the containers must be exported under customs supervision within 3 months from such date, as provided by law; the other notice shall be retained as office record and later returned as a report to the chief of the district. In all cases the importer shall return his notice to the District Director of Customs, properly certified as to the information required, as the form provides.

### § 1230.48 Relabeling of containers.

(a) If containers are to be released after relabeling, a notice shall be sent by the chief of district direct to the importer, a carbon copy being sent to the

**§ 1230.49**

**21 CFR Ch. I (4-1-20 Edition)**

District Director of Customs. This notice must state specifically the conditions to be performed, so as to bring the performance thereof under the provisions of the customs bonds on consumption and warehouse entries, these bonds including provisions requiring compliance with all of the requirements of the Federal Caustic Poison Act and all regulations and instructions issued thereunder. The notice will also state the officer to be notified by the importer when the containers are ready for inspection.

(b) The importer must return the notice to the District Director of Customs or chief of district, as designated, with the certificate thereon filled out, stating that he has complied with the prescribed conditions and that the containers are ready for inspection at the place named.

(c) This notice will be delivered to the inspection officer, who, after inspection, will endorse the result thereof on the back of the notice and return the same to the District Director of Customs or to the chief of district, as the case may be.

(d) When the conditions to be complied with are under the supervision of the chief of district, and these conditions have been fully met, he shall release the containers to the importer, sending a copy of the notice of release to the District Director of Customs for his information. If the containers have not been properly relabeled within the period allowed, the chief of district shall immediately give notice in duplicate to the District Director of Customs of the results of inspection. The District Director of Customs shall sign and immediately transmit one copy of the notice to the importer and proceed in the usual manner.

(e) If the containers are detained subject to relabeling to be performed under the supervision of the District Director of Customs, the District Director of Customs, as soon as relabeling is accomplished, will notify the importer that the containers are released.

(f) If the containers have not been properly relabeled within the period allowed, their sale after labeling as required by the act or other disposition

must be effected by the District Director of Customs.

(g) When the final action has been taken on containers which have been refused admission, sold, or otherwise disposed of as provided for by the act or which have been relabeled under the supervision of the District Director of Customs, he shall send to the chief of district a notice of such final action, giving the date and disposition.

(h) When relabeling is allowed the importer must furnish satisfactory evidence as to the identity of the containers before release is given. The relabeling must be done at a stated place and apart from other containers of a similar nature.

(i) When containers are shipped to another port for relabeling or exportation, they must be shipped under customs carrier's manifest, in the same manner as shipments in bond.

(j) District Directors of Customs will perform the inspection service whenever containers are to be exported, sold, or otherwise disposed of, and in other cases when there is no officer of the district available.

(k) District Directors of Customs and representatives of the district will confer and arrange the apportionment of the inspection service according to local conditions. Officers of the district will, whenever feasible, perform the inspection service in connection with relabeling.

**§ 1230.49 Penalties.**

(a) In case of failure to comply with the instructions or recommendations of the chief of district as to conditions under which containers may be disposed of, the District Director of Customs shall notify the chief of district in all cases coming to his attention within 3 days after inspection or after the expiration of the 3 months allowed by law if no action is taken.

(b) The chief of district, upon receipt of the above-described notice, and in all cases of failure to meet the conditions imposed in order to comply with the provisions of the Federal Caustic Poison Act coming directly under his supervision, shall transmit to the District Director of Customs such evidence as he may have at hand tending

to indicate the importer's liability and make a recommendation accordingly.

(c) The District Director of Customs, within 3 days of the receipt of this recommendation, whether favorable or otherwise, shall notify the importer that, the legal period of 3 months for exportation or relabeling having expired, action will be taken within 30 days to enforce the terms of the bond.

## PART 1240—CONTROL OF COMMUNICABLE DISEASES

### Subpart A—General Provisions

Sec.

1240.3 General definitions.

1240.10 Effective bactericidal treatment.

### Subpart B—Administrative Procedures

1240.20 Issuance and posting of certificates following inspections.

1240.30 Measures in the event of inadequate local control.

1240.45 Report of disease.

### Subpart C [Reserved]

### Subpart D—Specific Administrative Decisions Regarding Interstate Shipments

1240.60 Molluscan shellfish.

1240.61 Mandatory pasteurization for all milk and milk products in final package form intended for direct human consumption.

1240.62 Turtles intrastate and interstate requirements.

1240.65 Psittacine birds.

1240.75 Garbage.

### Subpart E—Source and Use of Potable Water

1240.80 General requirements for water for drinking and culinary purposes.

1240.83 Approval of watering points.

1240.86 Protection of pier water system.

1240.90 Approval of treatment aboard conveyances.

1240.95 Sanitation of water boats.

AUTHORITY: 42 U.S.C. 216, 243, 264, 271.

CROSS REFERENCES: For Department of Health and Human Services regulations relating to foreign quarantine, sanitation measures, and control of communicable diseases, see Centers for Disease Control's requirements as set forth in 42 CFR parts 71 and 72.

SOURCE: 40 FR 5620, Feb. 6, 1975, unless otherwise noted.

## Subpart A—General Provisions

### § 1240.3 General definitions.

As used in this part, terms shall have the following meaning:

(a) *Bactericidal treatment*. The application of a method or substance for the destruction of pathogens and other organisms as set forth in § 1240.10.

(b) *Communicable diseases*. Illnesses due to infectious agents or their toxic products, which may be transmitted from a reservoir to a susceptible host either directly as from an infected person or animal or indirectly through the agency of an intermediate plant or animal host, vector, or the inanimate environment.

(c) *Communicable period*. The period or periods during which the etiologic agent may be transferred directly or indirectly from the body of the infected person or animal to the body of another.

(d) *Contamination*. The presence of a certain amount of undesirable substance or material, which may contain pathogenic microorganisms.

(e) *Conveyance*. Conveyance means any land or air carrier, or any vessel as defined in paragraph (n) of this section.

(f) *Garbage*. (1) The solid animal and vegetable waste, together with the natural moisture content, resulting from the handling, preparation, or consumption of foods in houses, restaurants, hotels, kitchens, and similar establishments, or (2) any other food waste containing pork.

(g) *Incubation period*. The period between the implanting of disease organisms in a susceptible person and the appearance of clinical manifestation of the disease.

(h) *Interstate traffic*. (1) The movement of any conveyance or the transportation of persons or property, including any portion of such movement or transportation which is entirely within a State or possession,

(i) From a point of origin in any State or possession to a point of destination in any other State or possession, or

(ii) Between a point of origin and a point of destination in the same State or possession but through any other State, possession, or contiguous foreign country.

§ 1240.10

21 CFR Ch. I (4-1-20 Edition)

(2) Interstate traffic does not include the following:

(i) The movement of any conveyance which is solely for the purpose of unloading persons or property transported from a foreign country, or loading persons or property for transportation to a foreign country.

(ii) The movement of any conveyance which is solely for the purpose of effecting its repair, reconstruction, rehabilitation, or storage.

(i) *Milk*. Milk is the product defined in §131.110 of this chapter.

(j) *Milk products*. Food products made exclusively or principally from the lacteal secretion obtained from one or more healthy milk-producing animals, e.g., cows, goats, sheep, and water buffalo, including, but not limited to, the following: lowfat milk, skim milk, cream, half and half, dry milk, nonfat dry milk, dry cream, condensed or concentrated milk products, cultured or acidified milk or milk products, kefir, eggnog, yogurt, butter, cheese (where not specifically exempted by regulation), whey, condensed or dry whey or whey products, ice cream, ice milk, other frozen dairy desserts and products obtained by modifying the chemical or physical characteristics of milk, cream, or whey by using enzymes, solvents, heat, pressure, cooling, vacuum, genetic engineering, fractionation, or other similar processes, and any such product made by the addition or subtraction of milkfat or the addition of safe and suitable optional ingredients for the protein, vitamin, or mineral fortification of the product.

(k) *Minimum heat treatment*. The causing of all particles in garbage to be heated to a boiling temperature and held at that temperature for a period of not less than 30 minutes.

(l) *Possession*. Any of the possessions of the United States, including Puerto Rico and the Virgin Islands.

(m) *Potable water*. Water which meets the standards prescribed in the Environmental Protection Agency's Primary Drinking Water Regulations as set forth in 40 CFR part 141 and the Food and Drug Administration's sanitation requirements as set forth in this part and part 1250 of this chapter.

(n) *State*. Any State, the District of Columbia, Puerto Rico and the Virgin Islands.

(o) *Utensil*. Includes any kitchenware, tableware, glassware, cutlery, containers, or equipment with which food or drink comes in contact during storage, preparation, or serving.

(p) *Vessel*. Any passenger-carrying, cargo, or towing vessel exclusive of:

(1) Fishing boats including those used for shell-fishing;

(2) Tugs which operate only locally in specific harbors and adjacent waters;

(3) Barges without means of self-propulsion;

(4) Construction-equipment boats and dredges; and

(5) Sand and gravel dredging and handling boats.

(q) *Watering point*. The specific place or water boat from which potable water is loaded on a conveyance.

(r) *Molluscan shellfish*. Any edible species of fresh or frozen oysters, clams, mussels, and scallops or edible portions thereof, except when the product consists entirely of the shucked adductor muscle.

(s) *Certification number* means a unique combination of letters and numbers assigned by a shellfish control authority to a molluscan shellfish processor.

(t) *Shellfish control authority* means a Federal, State, or foreign agency, or sovereign tribal government, legally responsible for the administration of a program that includes activities such as classification of molluscan shellfish growing areas, enforcement of molluscan shellfish harvesting controls, and certification of molluscan shellfish processors.

(u) *Tag* means a record of harvesting information attached to a container of shellstock by the harvester or processor.

[40 FR 5620, Feb. 6, 1975, as amended at 48 FR 11431, Mar. 18, 1983; 57 FR 57344, Dec. 4, 1992; 60 FR 65201, Dec. 18, 1995]

**§ 1240.10 Effective bactericidal treatment.**

Whenever, under the provisions of this part, bactericidal treatment is required, it shall be accomplished by one or more of the following methods:

(a) By immersion of the utensil or equipment for at least 2 minutes in clean hot water at a temperature of at least 170 °F or for one-half minute in boiling water;

(b) By immersion of the utensil or equipment for at least 2 minutes in a lukewarm chlorine bath containing at least 50 ppm of available chlorine if hypochlorites are used or a concentration of equal bactericidal strength if chloramines are used;

(c) By exposure of the utensil or equipment in a steam cabinet at a temperature of at least 170 °F for at least 15 minutes or at a temperature of 200 °F for at least 5 minutes;

(d) By exposure of the utensil or equipment in an oven or hot air cabinet at a temperature of at least 180 °F for at least 20 minutes;

(e) In the case of utensils or equipment so designed or installed as to make immersion or exposure impractical, the equipment may be treated for the prescribed periods of time either at the temperatures or with chlorine solutions as specified above, (1) with live steam from a hose if the steam can be confined, (2) with boiling rinse water, or (3) by spraying or swabbing with chlorine solution;

(f) Any other method determined by the Commissioner of Food and Drugs, upon application of an owner or operator of a conveyance, to be effective to prevent the spread of communicable disease.

[40 FR 5620, Feb. 6, 1975, as amended at 54 FR 24900, June 12, 1989]

### Subpart B—Administrative Procedures

#### § 1240.20 Issuance and posting of certificates following inspections.

The Commissioner of Food and Drugs may issue certificates based upon inspections provided for in this part and part 1250. Such certificates shall be prominently posted on conveyances.

[40 FR 5620, Feb. 6, 1975, as amended at 48 FR 11431, Mar. 18, 1983]

#### § 1240.30 Measures in the event of inadequate local control.

Whenever the Commissioner of Food and Drugs determines that the meas-

ures taken by health authorities of any State or possession (including political subdivisions thereof) are insufficient to prevent the spread of any of the communicable diseases from such State or possession to any other State or possession, he may take such measures to prevent such spread of the diseases as he deems reasonably necessary, including inspection, fumigation, disinfection, sanitation, pest extermination, and destruction of animals or articles believed to be sources of infection.

[40 FR 5620, Feb. 6, 1975, as amended at 48 FR 11431, Mar. 18, 1983]

#### § 1240.45 Report of disease.

The master of any vessel or person in charge of any conveyance engaged in interstate traffic, on which a case or suspected case of a communicable disease develops shall, as soon as practicable, notify the local health authority at the next port of call, station, or stop, and shall take such measures to prevent the spread of the disease as the local health authority directs.

### Subpart C [Reserved]

### Subpart D—Specific Administrative Decisions Regarding Interstate Shipments

#### § 1240.60 Molluscan shellfish.

(a) A person shall not offer for transportation, or transport, in interstate traffic any molluscan shellfish handled or stored in such an insanitary manner, or grown in an area so contaminated, as to render such molluscan shellfish likely to become agents in, and their transportation likely to contribute to the spread of communicable disease from one State or possession to another.

(b) All shellstock shall bear a tag that discloses the date and place they were harvested (by State and site), type and quantity of shellfish, and by whom they were harvested (i.e., the identification number assigned to the harvester by the shellfish control authority, where applicable or, if such identification numbers are not assigned, the name of the harvester or the name or registration number of the harvester's vessel). In place of the tag,

**§ 1240.61**

bulk shellstock shipments may be accompanied by a bill of lading or similar shipping document that contains the same information.

(c) All containers of shucked molluscan shellfish shall bear a label that identifies the name, address, and certification number of the packer or repacker of the molluscan shellfish.

(d) Any molluscan shellfish without such a tag, shipping document, or label, or with a tag, shipping document, or label that does not bear all the information required by paragraphs (b) and (c) of this section, shall be subject to seizure or refusal of entry, and destruction.

[40 FR 5620, Feb. 6, 1975, as amended at 60 FR 65202, Dec. 18, 1995]

**§ 1240.61 Mandatory pasteurization for all milk and milk products in final package form intended for direct human consumption.**

(a) No person shall cause to be delivered into interstate commerce or shall sell, otherwise distribute, or hold for sale or other distribution after shipment in interstate commerce any milk or milk product in final package form for direct human consumption unless the product has been pasteurized or is made from dairy ingredients (milk or milk products) that have all been pasteurized, except where alternative procedures to pasteurization are provided for by regulation, such as in part 133 of this chapter for curing of certain cheese varieties.

(b) Except as provided in paragraphs (c) and (d) of this section, the terms "pasteurization," "pasteurized," and similar terms shall mean the process of heating every particle of milk and milk product in properly designed and operated equipment to one of the temperatures given in the following table and held continuously at or above that temperature for at least the corresponding specified time:

Temperature	Time
145 °F (63 °C) <sup>1</sup> .....	30 minutes.
161 °F (72 °C) <sup>1</sup> .....	15 seconds.
191 °F (89 °C) .....	1 second.

<sup>1</sup> If the fat content of the milk product is 10 percent or more, or if it contains added sweeteners, the specified temperature shall be increased by 5 °F (3 °C).

**21 CFR Ch. I (4-1-20 Edition)**

Temperature	Time
194 °F (90 °C) .....	0.5 second.
201 °F (94 °C) .....	0.1 second.
204 °F (96 °C) .....	0.05 second.
212 °F (100 °C) .....	0.01 second.

(c) Eggnog shall be heated to at least the following temperature and time specification:

Temperature	Time
155 °F (69 °C) .....	30 minutes.
175 °F (80 °C) .....	25 seconds.
180 °F (83 °C) .....	15 seconds.

(d) Neither paragraph (b) nor (c) of this section shall be construed as barring any other pasteurization process that has been recognized by the Food and Drug Administration to be equally efficient in the destruction of microbial organisms of public health significance.

[52 FR 29514, Aug. 10, 1987, as amended at 57 FR 57344, Dec. 4, 1992]

**§ 1240.62 Turtles intrastate and interstate requirements.**

(a) *Definition.* As used in this section the term "turtles" includes all animals commonly known as turtles, tortoises, terrapins, and all other animals of the order Testudinata, class Reptilia, except marine species (families Dermachelidae and Chelonidae).

(b) *Sales; general prohibition.* Except as otherwise provided in this section, viable turtle eggs and live turtles with a carapace length of less than 4 inches shall not be sold, held for sale, or offered for any other type of commercial or public distribution.

(c) *Exceptions.* The provisions of this section are not applicable to:

(1) The sale, holding for sale, and distribution of live turtles and viable turtle eggs for bona fide scientific, educational, or exhibitional purposes, other than use as pets.

(2) The sale, holding for sale, and distribution of live turtles and viable turtle eggs not in connection with a business.

(3) The sale, holding for sale, and distribution of live turtles and viable turtle eggs intended for export only, provided that the outside of the shipping package is conspicuously labeled "For Export Only."

(4) Marine turtles excluded from this regulation under the provisions of paragraph (a) of this section and eggs of such turtles.

(d) *Petitions.* The Commissioner of Food and Drugs, either on his own initiative or on behalf of any interested person who has submitted a petition, may publish a proposal to amend this regulation. Any such petition shall include an adequate factual basis to support the petition, and will be published for comment if it contains reasonable grounds for the proposed regulation. A petition requesting such a regulation, which would amend this regulation, shall be submitted to the Division of Dockets Management, Food and Drug Administration, 5630 Fishers Lane, rm. 1061, Rockville, MD 20852.

[40 FR 22545, May 23, 1975, as amended at 46 FR 8461, Jan. 27, 1981; 48 FR 11431, Mar. 18, 1983; 54 FR 24900, June 12, 1989; 59 FR 14366, Mar. 28, 1994; 66 FR 56035, Nov. 6, 2001; 70 FR 48073, Aug. 18, 2005; 78 FR 44881, July 25, 2013]

#### § 1240.65 Psittacine birds.

(a) The term psittacine birds shall include all birds commonly known as parrots, Amazons, Mexican double heads, African grays, cocatoos, macaws, parakeets, love birds, lorries, lorikeets, and all other birds of the psittacine family.

(b) No person shall transport, or offer for transportation, in interstate traffic any psittacine bird unless the shipment is accompanied by a permit from the State health department of the State of destination where required by such department.

(c) Whenever the Surgeon General finds that psittacine birds or human beings in any area are infected with psittacosis and there is such danger of transmission of psittacosis from such area as to endanger the public health, he may declare it an area of infection. No person shall thereafter transport, or offer for transportation, in interstate traffic any psittacine bird from such area, except shipments authorized by the Surgeon General for purposes of medical research and accompanied by a permit issued by him, until the Surgeon General finds that there is no longer any danger of transmission of psittacosis from such area. As used in this paragraph, the term "area" in-

cludes, but is not limited to, specific premises or buildings.

#### § 1240.75 Garbage.

(a) A person shall not transport, receive, or cause to be transported or received, garbage in interstate traffic and feed such garbage to swine unless, prior to the feeding, such garbage has received minimum heat treatment.

(b) A person transporting garbage in interstate traffic shall not make, or agree to make, delivery thereof to any person with knowledge of the intent or customary practice of such person to feed to swine garbage which has not been subjected to minimum heat treatment.

### Subpart E—Source and Use of Potable Water

#### § 1240.80 General requirements for water for drinking and culinary purposes.

Only potable water shall be provided for drinking and culinary purposes by any operator of a conveyance engaged in interstate traffic, except as provided in §1250.84(b) of this chapter. Such water shall either have been obtained from watering points approved by the Commissioner of Food and Drugs, or, if treated aboard a conveyance, shall have been subjected to treatment approved by the Commissioner of Food and Drugs.

[40 FR 5620, Feb. 6, 1975, as amended at 48 FR 11431, Mar. 18, 1983]

#### § 1240.83 Approval of watering points.

(a) The Commissioner of Food and Drugs shall approve any watering point if (1) the water supply thereat meets the standards prescribed in the Environmental Protection Agency's Primary Drinking Water Regulations as set forth in 40 CFR part 141, and (2) the methods of and facilities for delivery of such water to the conveyance and the sanitary conditions surrounding such delivery prevent the introduction, transmission, or spread of communicable diseases.

(b) The Commissioner of Food and Drugs may base his approval or disapproval of a watering point upon investigations made by representatives

## § 1240.86

of State departments of health or of the health authorities of contiguous foreign nations.

(c) If a watering point has not been approved, the Commissioner of Food and Drugs may permit its temporary use under such conditions as, in his judgment, are necessary to prevent the introduction, transmission, or spread of communicable diseases.

(d) Upon request of the Commissioner of Food and Drugs, operators of conveyances shall provide information as to watering points used by them.

[40 FR 5620, Feb. 6, 1975, as amended at 48 FR 11431, Mar. 18, 1983; 48 FR 13978, Apr. 1, 1983]

## § 1240.86 Protection of pier water system.

No vessel engaged in interstate traffic shall make a connection between its nonpotable water system and any pier potable water system unless provisions are made to prevent backflow from the vessel to the pier.

## § 1240.90 Approval of treatment aboard conveyances.

(a) The treatment of water aboard conveyances shall be approved by the Commissioner of Food and Drugs if the apparatus used is of such design and is so operated as to be capable of producing and in fact does produce, potable water.

(b) The Commissioner of Food and Drugs may base his approval or disapproval of the treatment of water upon investigations made by representatives of State departments of health or of the health authorities of contiguous foreign nations.

(c) Overboard water treated on vessels shall be from areas relatively free of contamination and pollution.

[40 FR 5620, Feb. 6, 1975, as amended at 48 FR 11431, Mar. 18, 1983]

## § 1240.95 Sanitation of water boats.

No vessel engaged in interstate traffic shall obtain water for drinking and culinary purposes from any water boat unless the tanks, piping, and other appurtenances used by the water boat in the loading, transportation, and delivery of such drinking and culinary

## 21 CFR Ch. I (4-1-20 Edition)

water, have been approved by the Commissioner of Food and Drugs.

[40 FR 5620, Feb. 6, 1975, as amended at 48 FR 11431, Mar. 18, 1983]

## PART 1250—INTERSTATE CONVEYANCE SANITATION

### Subpart A—General Provisions

Sec.

1250.3 Definitions.

### Subpart B—Food Service Sanitation on Land and Air Conveyances, and Vessels

- 1250.20 Applicability.
- 1250.21 Inspection.
- 1250.22 General requirements.
- 1250.25 Source identification and inspection of food and drink.
- 1250.26 Special food requirements.
- 1250.27 Storage of perishables.
- 1250.28 Source and handling of ice.
- 1250.30 Construction, maintenance and use of places where food is prepared, served, or stored.
- 1250.32 Food-handling operations.
- 1250.33 Utensils and equipment.
- 1250.34 Refrigeration equipment.
- 1250.35 Health of persons handling food.
- 1250.38 Toilet and lavatory facilities for use of food-handling employees.
- 1250.39 Garbage equipment and disposition.

### Subpart C—Equipment and Operation of Land and Air Conveyances

- 1250.40 Applicability.
- 1250.41 Submittal of construction plans.
- 1250.42 Water systems; constant temperature bottles.
- 1250.43 Ice.
- 1250.44 Drinking utensils and toilet articles.
- 1250.45 Food handling facilities on railroad conveyances.
- 1250.49 Cleanliness of conveyances.
- 1250.50 Toilet and lavatory facilities.
- 1250.51 Railroad conveyances; discharge of wastes.
- 1250.52 Discharge of wastes on highway conveyances.
- 1250.53 Discharge of wastes on air conveyances.

### Subpart D—Servicing Areas for Land and Air Conveyances

- 1250.60 Applicability.
- 1250.61 Inspection and approval.
- 1250.62 Submittal of construction plans.
- 1250.63 General requirements.
- 1250.65 Drainage.
- 1250.67 Watering equipment.
- 1250.70 Employee conveniences.
- 1250.75 Disposal of human wastes.



## Food and Drug Administration, HHS

## § 1250.3

1250.79 Garbage disposal.

### Subpart E—Sanitation Facilities and Conditions on Vessels

1250.80 Applicability.  
1250.81 Inspection.  
1250.82 Potable water systems.  
1250.83 Storage of water prior to treatment.  
1250.84 Water in galleys and medical care spaces.  
1250.85 Drinking fountains and coolers; ice; constant temperature bottles.  
1250.86 Water for making ice.  
1250.87 Wash water.  
1250.89 Swimming pools.  
1250.90 Toilets and lavatories.  
1250.93 Discharge of wastes.  
1250.95 Insect control.  
1250.96 Rodent control.

AUTHORITY: 42 U.S.C. 216, 243, 264, 271.

CROSS REFERENCES: For Department of Health and Human Services regulations relating to foreign quarantine and control of communicable diseases, see Centers for Disease Control's requirements as set forth in 42 CFR parts 71 and 72.

SOURCE: 40 FR 5624, Feb. 6, 1975, unless otherwise noted.

### Subpart A—General Provisions

#### § 1250.3 Definitions.

As used in this part, terms shall have the following meaning:

(a) *Bactericidal treatment*. The application of a method or substance for the destruction of pathogens and other organisms as set forth in §1240.10 of this chapter.

(b) *Communicable diseases*. Illnesses due to infectious agents or their toxic products, which may be transmitted from a reservoir to a susceptible host either directly as from an infected person or animal or indirectly through the agency of an intermediate plant or animal host, vector, or the inanimate environment.

(c) *Communicable period*. The period or periods during which the etiologic agent may be transferred directly or indirectly from the body of the infected person or animal to the body of another.

(d) *Contamination*. The presence of a certain amount of undesirable substance or material, which may contain pathogenic microorganisms.

(e) *Conveyance*. Conveyance means any land or air carrier, or any vessel as

defined in paragraph (m) of this section.

(f) *Existing vessel*. Any vessel the construction of which was started prior to the effective date of the regulations in this part.

(g) *Garbage*. (1) The solid animal and vegetable waste, together with the natural moisture content, resulting from the handling, preparation, or consumption of foods in houses, restaurants, hotels, kitchens, and similar establishments, or (2) any other food waste containing pork.

(h) *Interstate traffic*. (1) The movement of any conveyance or the transportation of persons or property, including any portion of such movement or transportation which is entirely within a State or possession, (i) from a point of origin in any State or possession to a point of destination in any other State or possession, or (ii) between a point of origin and a point of destination in the same State or possession but through any other State, possession, or contiguous foreign country.

(2) Interstate traffic does not include the following:

(i) The movement of any conveyance which is solely for the purpose of unloading persons or property transported from a foreign country, or loading persons or property for transportation to a foreign country.

(ii) The movement of any conveyance which is solely for the purpose of effecting its repair, reconstruction, rehabilitation, or storage.

(i) *Possession*. Any of the possessions of the United States, including Puerto Rico and the Virgin Islands.

(j) *Potable water*. Water which meets the standards prescribed in the Environmental Protection Agency's Primary Drinking Water Regulations as set forth in 40 CFR part 141 and the Food and Drug Administration's sanitation regulations as set forth in this part and part 1240 of this chapter.

(k) *State*. Any State, the District of Columbia, Puerto Rico and the Virgin Islands.

(l) *Utensil*. Includes any kitchenware, tableware, glassware, cutlery, containers, or equipment with which food or drink comes in contact during storage, preparation, or serving.

## § 1250.20

(m) *Vessel*. Any passenger-carrying, cargo, or towing vessel exclusive of:

(1) Fishing boats including those used for shell-fishing;

(2) Tugs which operate only locally in specific harbors and adjacent waters;

(3) Barges without means of self-propulsion;

(4) Construction-equipment boats and dredges; and

(5) Sand and gravel dredging and handling boats.

(n) *Wash water*. Water suitable for domestic uses other than for drinking and culinary purposes, and medical care purposes excluding hydrotherapy.

(o) *Shellfish*. Any fresh, frozen, or incompletely cooked oysters, clams, or mussels, either shucked or in the shell, and any fresh, frozen, or incompletely cooked edible products thereof.

[40 FR 5624, Feb. 6, 1975, as amended at 48 FR 11432, Mar. 18, 1983]

## Subpart B—Food Service Sanitation on Land and Air Conveyances, and Vessels

### § 1250.20 Applicability.

All conveyances engaged in interstate traffic shall comply with the requirements prescribed in this subpart and § 1240.20 of this chapter.

### § 1250.21 Inspection.

The Commissioner of Food and Drugs may inspect such conveyance to determine compliance with the requirements of this subpart and § 1240.20 of this chapter.

[40 FR 5624, Feb. 6, 1975, as amended at 48 FR 11432, Mar. 18, 1983]

### § 1250.22 General requirements.

All food and drink served on conveyances shall be clean, wholesome, and free from spoilage, and shall be prepared, stored, handled, and served in accordance with the requirements prescribed in this subpart and § 1240.20 of this chapter.

### § 1250.25 Source identification and inspection of food and drink.

(a) Operators of conveyances shall identify, when requested by the Commissioner of Food and Drugs, the vendors, distributors or dealers from

## 21 CFR Ch. I (4–1–20 Edition)

whom they have acquired or are acquiring their food supply, including milk, fluid milk products, ice cream and other frozen desserts, butter, cheese, bottled water, sandwiches and box lunches.

(b) The Commissioner of Food and Drugs may inspect any source of such food supply in order to determine whether the requirements of the regulations in this subpart and in § 1240.20 of this chapter are being met, and may utilize the results of inspections of such sources made by representatives of State health departments or of the health authorities of contiguous foreign nations.

[40 FR 5624, Feb. 6, 1975, as amended at 48 FR 11432, Mar. 18, 1983]

### § 1250.26 Special food requirements.

Milk, fluid milk products, ice cream and other frozen desserts, butter, cheese, and shellfish served or sold on conveyances shall conform to the following requirements:

(a) Milk and fluid milk products, including cream, buttermilk, skim milk, milk beverages, and reconstituted milk, shall be pasteurized and obtained from a source of supply approved by the Commissioner of Food and Drugs. The Commissioner of Food and Drugs shall approve any source of supply at or from which milk or fluid milk products are produced, processed, and distributed so as to prevent the introduction, transmission, or spread of communicable diseases. If a source of supply of milk or fluid milk products has not been approved, the Commissioner of Food and Drugs may permit its temporary use under such conditions as, in his judgment, are necessary to prevent the introduction, transmission, or spread of communicable diseases. Containers of milk and fluid milk products shall be plainly labeled to show the contents, the word “pasteurized”, and the identity of the plant at which the contents were packaged by name and address, provided that a code may be used in lieu of address.

(b) Ice cream, other frozen desserts, and butter shall be manufactured from milk or milk products that have been pasteurized or subjected to equivalent heat treatment.

(c) Cheese shall be (1) pasteurized or subjected to equivalent heat treatment, (2) made from pasteurized milk products or from milk products which have been subjected to equivalent heat treatment, or (3) cured for not less than 60 days at a temperature not less than 35 °F.

(d) Milk, buttermilk, and milk beverages shall be served in or from the original individual containers in which received from the distributor, or from a bulk container equipped with a dispensing device so designed, constructed, installed, and maintained as to prevent the transmission of communicable diseases.

(e) Shellfish purchased for consumption on any conveyance shall originate from a dealer currently listed by the Public Health Service as holding an unexpired and unrevoked certificate issued by a State authority.

(f) Shucked shellfish shall be purchased in the containers in which they are placed at the shucking plant and shall be kept therein until used. The State abbreviation and the certificate number of the packers shall be permanently recorded on the container.

[40 FR 5624, Feb. 6, 1975, as amended at 48 FR 11432, Mar. 18, 1983]

#### § 1250.27 Storage of perishables.

All perishable food or drink shall be kept at or below 50 °F, except when being prepared or kept hot for serving.

#### § 1250.28 Source and handling of ice.

Ice coming in contact with food or drink and not manufactured on the conveyance shall be obtained from sources approved by competent health authorities. All ice coming in contact with food or drink shall be stored and handled in such manner as to avoid contamination.

#### § 1250.30 Construction, maintenance and use of places where food is prepared, served, or stored.

(a) All kitchens, galleys, pantries, and other places where food is prepared, served, or stored shall be adequately lighted and ventilated: *Provided, however,* That ventilation of cold storage rooms shall not be required. All such places where food is prepared, served, or stored shall be so con-

structed and maintained as to be clean and free from flies, rodents, and other vermin.

(b) Such places shall not be used for sleeping or living quarters.

(c) Water of satisfactory sanitary quality, under head or pressure, and adequate in amount and temperature, shall be easily accessible to all rooms in which food is prepared and utensils are cleaned.

(d) All plumbing shall be so designed, installed, and maintained as to prevent contamination of the water supply, food, and food utensils.

#### § 1250.32 Food-handling operations.

(a) All food-handling operations shall be accomplished so as to minimize the possibility of contaminating food, drink, or utensils.

(b) The hands of all persons shall be kept clean while engaged in handling food, drink, utensils, or equipment.

#### § 1250.33 Utensils and equipment.

(a) All utensils and working surfaces used in connection with the preparation, storage, and serving of food or beverages, and the cleaning of food utensils, shall be so constructed as to be easily cleaned and self-draining and shall be maintained in good repair. Adequate facilities shall be provided for the cleaning and bactericidal treatment of all multiuse eating and drinking utensils and equipment used in the preparation of food and beverages. An indicating thermometer, suitably located, shall be provided to permit the determination of the hot water temperature when and where hot water is used as the bactericidal agent.

(b) All multiuse eating and drinking utensils shall be thoroughly cleaned in warm water and subjected to an effective bactericidal treatment after each use. All other utensils that come in contact with food and drink shall be similarly treated immediately following the day's operation. All equipment shall be kept clean.

(c) After bactericidal treatment, utensils shall be stored and handled in such manner as to prevent contamination before reuse.

**§ 1250.34**

**§ 1250.34 Refrigeration equipment.**

Each refrigerator shall be equipped with a thermometer located in the warmest portion thereof. Waste water drains from ice boxes, refrigerating equipment, and refrigerated spaces shall be so installed as to prevent back-flow of contaminating liquids.

**§ 1250.35 Health of persons handling food.**

(a) Any person who is known or suspected to be in a communicable period or a carrier of any communicable disease shall not be permitted to engage in the preparation, handling, or serving of water, other beverages, or food.

(b) Any person known or suspected to be suffering from gastrointestinal disturbance or who has on the exposed portion of the body an open lesion or an infected wound shall not be permitted to engage in the preparation, handling, or serving of food or beverages.

**§ 1250.38 Toilet and lavatory facilities for use of food-handling employees.**

(a) Toilet and lavatory facilities of suitable design and construction shall be provided for use of food-handling employees. Railroad dining car crew lavatory facilities are regulated under § 1250.45.

(b) Signs directing food-handling employees to wash their hands after each use of toilet facilities shall be posted so as to be readily observable by such employees. Hand washing facilities shall include soap, sanitary towels and hot and cold running water or warm running water in lieu of hot and cold running water.

(c) All toilet rooms shall be maintained in a clean condition.

**§ 1250.39 Garbage equipment and disposition.**

Watertight, readily cleanable non-absorbent containers with close-fitting covers shall be used to receive and store garbage. Garbage and refuse shall be disposed of as frequently as is necessary and practicable.

**21 CFR Ch. I (4-1-20 Edition)**

**Subpart C—Equipment and Operation of Land and Air Conveyances**

**§ 1250.40 Applicability.**

The sanitary equipment and facilities on land and air conveyances engaged in interstate traffic and the use of such equipment and facilities shall comply with the requirements prescribed in this subpart.

**§ 1250.41 Submittal of construction plans.**

Plans for the construction or major reconstruction of sanitary equipment or facilities for such conveyances shall be submitted to the Commissioner of Food and Drugs for review of the conformity of such plans with the requirements of this subpart, except that submittal of plans shall not be required for any conveyance under reconstruction if the owner or operator thereof has made arrangements satisfactory to the Commissioner of Food and Drugs for inspections of such conveyances while under reconstruction for the purpose of determining conformity with those requirements.

[40 FR 5624, Feb. 6, 1975, as amended at 48 FR 11432, Mar. 18, 1983]

**§ 1250.42 Water systems; constant temperature bottles.**

(a) The water system, whether of the pressure or gravity type, shall be complete and closed from the filling ends to the discharge taps, except for protected vent openings. The water system shall be protected against back-flow.

(b) Filling pipes or connections through which water tanks are supplied shall be provided on both sides of all new railway conveyances and on existing conveyances when they undergo heavy repairs. All filling connections shall be easily cleanable and so located and protected as to minimize the hazard of contamination of the water supply.

(c) On all new or reconstructed conveyances, water coolers shall be an integral part of the closed system.

(d) Water filters if used on dining cars and other conveyances will be permitted only if they are so operated and

## Food and Drug Administration, HHS

## § 1250.51

maintained at all times as to prevent contamination of the water.

(e) Constant temperature bottles and other containers used for storing or dispensing potable water shall be kept clean at all times and shall be subjected to effective bactericidal treatment as often as may be necessary to prevent the contamination of water so stored and dispensed.

### § 1250.43 Ice.

Ice shall not be permitted to come in contact with water in coolers or constant temperature bottles.

### § 1250.44 Drinking utensils and toilet articles.

(a) No cup, glass, or other drinking utensil which may be used by more than one person shall be provided on any conveyance unless such cup, glass, or drinking utensil shall have been thoroughly cleaned and subjected to effective bactericidal treatment after each individual use.

(b) Towels, combs, or brushes for common use shall not be provided.

### § 1250.45 Food handling facilities on railroad conveyances.

(a) Both kitchens and pantries of cars hereafter constructed or reconstructed shall be equipped with double sinks, one of which shall be of sufficient size and depth to permit complete immersion of a basket of dishes during bactericidal treatment; in the pantry a dishwashing machine may be substituted for the double sinks. If chemicals are used for bactericidal treatment, 3-compartment sinks shall be provided.

(b) A sink shall be provided for washing and handling cracked ice used in food or drink and shall be used for no other purpose.

(c) Lavatory facilities for the use of the dining car crew shall be provided on each dining car. Such facilities shall be conveniently located and used for hand and face washing only: *Provided, however,* That where the kitchen and pantry on a dining car hereafter constructed or reconstructed are so partitioned or separated as to impede free passage between them lavatory facilities shall be provided in both the kitchen and the pantry.

(d) Wherever toilet and lavatory facilities required by paragraph (c) of this section are not on the dining car, a lavatory shall be provided on the dining car for the use of employees. The lavatory shall be conveniently located and used only for the purpose for which it is installed.

### § 1250.49 Cleanliness of conveyances.

Conveyances while in transit shall be kept clean and free of flies and mosquitoes. A conveyance which becomes infected with vermin shall be placed out of service until such time as it shall have been effectively treated for the destruction of the vermin.

### § 1250.50 Toilet and lavatory facilities.

Where toilet and lavatory facilities are provided on conveyances they shall be so designed as to permit ready cleaning. On conveyances not equipped with retention facilities, toilet hoppers shall be of such design and so located as to prevent spattering of water filling pipes or hydrants.

### § 1250.51 Railroad conveyances; discharge of wastes.

(a) *New railroad conveyances.* Human wastes, garbage, waste water, or other polluting materials shall not be discharged from any new railroad conveyance except at servicing areas approved by the Commissioner of Food and Drugs. In lieu of retention pending discharge at approved servicing areas, human wastes, garbage, waste water, or other polluting materials that have been suitably treated to prevent the spread of communicable diseases may be discharged from such conveyances, except at stations. For the purposes of this section, "new railroad conveyance" means any such conveyance placed into service for the first time after July 1, 1972, and the terms "waste water or other polluting materials" do not include drainage of drinking water taps or lavatory facilities.

(b) *Nonnew railroad conveyances.* Human wastes, garbage, waste water, or other polluting materials shall not be discharged from any railroad conveyance, other than passenger conveyances for which an extension has been granted pursuant to paragraph (f) of this section, after December 31, 1977,

except at servicing areas approved by the Commissioner of Food and Drugs. In lieu of retention pending discharge at approved servicing areas, human wastes, garbage, waste water, or other polluting materials that have been suitably treated to prevent the spread of communicable diseases may be discharged from such conveyances, except at stations. The terms "waste water or other polluting materials" do not include drainage of drinking water taps or lavatory facilities.

(c) *Toilets.* When railroad conveyances, occupied or open to occupancy by travelers, are at a station or servicing area, toilets shall be kept locked unless means are provided to prevent contamination of the area or station.

(d) *Submission of annual report.* Each railroad company shall submit to the Center for Food Safety and Applied Nutrition (HFS-627), Food and Drug Administration, 5001 Campus Dr., College Park, MD 20740, an annual report of accomplishments made in modifying conveyances to achieve compliance with paragraph (b) of this section. Annual reports shall be required until a report is submitted showing that 100 percent of the company's conveyances can comply with the requirements of paragraph (b) of this section; annual reports shall be required subsequent to such report if conveyances not capable of complying with the requirements of paragraph (b) of this section are acquired. Every railroad company shall have not less than 10 percent of its nonpassenger conveyances that are in operation capable of complying with the requirements of paragraph (b) of this section by December 31, 1974, not less than 40 percent by December 31, 1975, and not less than 70 percent by December 31, 1976. All conveyances, other than passenger conveyances for which an extension has been granted pursuant to paragraph (f) of this section, in operation after December 31, 1977, shall be capable of complying with paragraph (b) of this section.

(e) *Requirements of annual report.* Annual reports required by paragraph (d) of this section shall be submitted within 60 days of the end of each calendar year. Each report shall contain at least the following information:

(1) Company name and address.

(2) Name, title, and address of the company's chief operating official.

(3) Name, title, address, and telephone number of the person designated by the company to be directly responsible for compliance with this section.

(4) A statement that all new railroad conveyances placed into service after July 1, 1972 meet the requirements of this section.

(5) A complete, factual, narrative statement explaining why retrofitting of noncomplying nonnew conveyances is incomplete, if it is incomplete.

(6) A statement of the percentage of conveyances retrofitted with waste discharge facilities in compliance with this section as of the reporting date and the percentage expected to be completed by December 31st of the following year.

(7) A tabular report with the following vertical columns: equipment type, e.g., locomotive, caboose, passenger car, and any others having toilets; number of toilets per conveyance; number of each equipment type in operation; and number of each to be retrofitted by December 31st of each year until 100 percent compliance with this section is achieved.

(f) *Variances and extensions*—(1) *Variances.* Upon application by a railroad company, the Director, Center for Food Safety and Applied Nutrition, may grant a variance from the compliance schedule prescribed in paragraph (d) of this section for nonpassenger conveyances when the requested variance is required to prevent substantial disruption of the railroad company's operations. Such variance shall not affect the final deadline of compliance established in paragraph (d) of this section.

(2) *Extensions.* Upon application by a railroad company, the Director, Center for Food Safety and Applied Nutrition, may grant an extension of time for compliance with the requirements of paragraph (b) of this section beyond December 31, 1977, for passenger conveyances operated by railroad companies when compliance cannot be achieved without substantial disruption of the railroad company's operations.

(3) *Application for variance or extension.* Application for variances or extensions shall be submitted to the Food and Drug Administration, Center for Food Safety and Applied Nutrition, Manager, Interstate Travel Sanitation Sub-Program, HFF-312, 5001 Campus Dr., College Park, MD 20740, and shall include the following information:

(i) A detailed description of the proposed deviation from the requirements of paragraphs (b) or (d) of this section.

(ii) A report, current to the date of the request for a variance or extension, containing the information required by paragraph (e) of this section.

(4) *Administration of variances and extensions.* (i) Written notification of the granting or refusal of a variance or extension will be provided to the applying railroad company by the Director, Center for Food Safety and Applied Nutrition. The notification of a granted variance will state the approved deviation from the compliance schedule provided for in paragraph (d) of this section. The notification of a granted extension will state the final date for compliance with the provisions of paragraph (b) of this section.

(ii) A public file of requested variances and extensions, their disposition, and information relating to pending actions will be maintained in the Division of Dockets Management, 5630 Fishers Lane, rm. 1061, Rockville, MD 20852.

(iii) After notice to the railroad company and opportunity for hearing in accordance with part 16 of this chapter, a variance or extension may be withdrawn prior to its scheduled termination if the Director, Center for Food Safety and Applied Nutrition, determines that such withdrawal is necessary to protect the public health.

CROSS REFERENCE: For statutory exemptions for "intercity rail passenger service," see section 306(i) of 45 U.S.C. 546(i).

[40 FR 5624, Feb. 6, 1975, as amended at 40 FR 30110, July 17, 1975; 46 FR 8461, Jan. 27, 1981; 48 FR 11432, Mar. 18, 1983; 54 FR 24900, June 12, 1989; 59 FR 14366, Mar. 28, 1994; 61 FR 14481, Apr. 2, 1996; 66 FR 56035, Nov. 6, 2001; 81 FR 49897, July 29, 2016]

EFFECTIVE DATE NOTE: For a document staying the effectiveness of §1250.51 (b) and (d), see 42 FR 57122, Nov. 1, 1977.

#### § 1250.52 Discharge of wastes on highway conveyances.

There shall be no discharge of excrement, garbage, or waste water from a highway conveyance except at servicing areas approved by the Commissioner of Food and Drugs.

[40 FR 5624, Feb. 6, 1975, as amended at 48 FR 11432, Mar. 18, 1983]

#### § 1250.53 Discharge of wastes on air conveyances.

There shall be no discharge of excrement or garbage from any air conveyance except at servicing areas approved by the Commissioner of Food and Drugs.

[40 FR 5624, Feb. 6, 1975, as amended at 48 FR 11432, Mar. 18, 1983]

### Subpart D—Servicing Areas for Land and Air Conveyances

#### § 1250.60 Applicability.

Land and air conveyances engaged in interstate traffic shall use only such servicing areas within the United States as have been approved by the Commissioner of Food and Drugs as being in compliance with the requirements prescribed in this subpart.

[40 FR 5624, Feb. 6, 1975, as amended at 48 FR 11432, Mar. 18, 1983]

#### § 1250.61 Inspection and approval.

The Commissioner of Food and Drugs may inspect any such areas to determine whether they shall be approved. He may base his approval or disapproval on investigations made by representatives of State departments of health.

[40 FR 5624, Feb. 6, 1975, as amended at 48 FR 11432, Mar. 18, 1983]

#### § 1250.62 Submittal of construction plans.

Plans for construction or major reconstruction of sanitation facilities at servicing areas shall be submitted to the Commissioner of Food and Drugs for review of the conformity of the proposed facilities with the requirements of this subpart.

[40 FR 5624, Feb. 6, 1975, as amended at 48 FR 11432, Mar. 18, 1983]

## § 1250.63

## 21 CFR Ch. I (4-1-20 Edition)

### § 1250.63 General requirements.

Servicing areas shall be provided with all necessary sanitary facilities so operated and maintained as to prevent the spread of communicable diseases.

### § 1250.65 Drainage.

All platforms and other places at which water or food supplies are loaded onto or removed from conveyances shall be adequately drained so as to prevent pooling.

### § 1250.67 Watering equipment.

(a) *General requirements.* All servicing area piping systems, hydrants, taps, faucets, hoses, buckets, and other appurtenances necessary for delivery of drinking and culinary water to a conveyance shall be designed, constructed, maintained and operated in such a manner as to prevent contamination of the water.

(b) *Outlets for nonpotable water.* Outlets for nonpotable water shall be provided with fittings different from those provided for outlets for potable water and each nonpotable water outlet shall be posted with permanent signs warning that the water is unfit for drinking.

(c) *Ice.* If bulk ice is used for the cooling of drinking water or other beverages, or for food preservation purposes, equipment constructed so as not to become a factor in the transmission of communicable diseases shall be provided for the storage, washing, handling, and delivery to conveyances of such bulk ice, and such equipment shall be used for no other purposes.

### § 1250.70 Employee conveniences.

(a) There shall be adequate toilet, washroom, locker, and other essential sanitary facilities readily accessible for use of employees adjacent to places or areas where land and air conveyances are serviced, maintained, and cleaned. These facilities shall be maintained in a clean and sanitary condition at all times.

(b) In the case of diners not in a train but with a crew on board, adequate toilet facilities shall be available to the crew within a reasonable distance but not exceeding 500 feet of such diners.

(c) Drinking fountains and coolers shall be constructed of impervious,

nonoxidizing material, and shall be so designed and constructed as to be easily cleaned. The jet of a drinking fountain shall be slanting and the orifice of the jet shall be protected by a guard in such a manner as to prevent contamination thereof by droppings from the mouth. The orifice of such a jet shall be located a sufficient distance above the rim of the basin to prevent backflow.

### § 1250.75 Disposal of human wastes.

(a) At servicing areas and at stations where land and air conveyances are occupied by passengers the operations shall be so conducted as to avoid contamination of such areas and stations by human wastes.

(b) Toilet wastes shall be disposed of through sanitary sewers or by other methods assuring sanitary disposal of such wastes. All soil cans and removable containers shall be thoroughly cleaned before being returned to use. Equipment for cleaning such containers and for flushing nonremovable containers and waste carts shall be so designed as to prevent backflow into the water line, and such equipment shall be used for no purpose connected with the handling of food, water or ice.

(c) All persons who have handled soil cans or other containers which have come in contact with human wastes shall be required to wash their hands thoroughly with soap and warm water and to remove any garments which have become soiled with such wastes before engaging in any work connected with the loading, unloading, transporting or other handling of food, water or ice.

### § 1250.79 Garbage disposal.

(a) Water-tight, readily cleanable, nonabsorbent containers with close-fitting covers shall be used to receive and store garbage.

(b) Can washing and draining facilities shall be provided.

(c) Garbage cans shall be emptied daily and shall be thoroughly washed before being returned for use.



### Subpart E—Sanitation Facilities and Conditions on Vessels

#### § 1250.80 Applicability.

The sanitation facilities and the sanitary conditions on vessels engaged in interstate traffic shall comply with the requirements prescribed in this subpart, provided that no major structural change will be required on existing vessels.

#### § 1250.81 Inspection.

The Commissioner of Food and Drugs may inspect such vessels to determine compliance with the requirements of this subpart.

[40 FR 5624, Feb. 6, 1975, as amended at 48 FR 11432, Mar. 18, 1983]

#### § 1250.82 Potable water systems.

The following conditions must be met by vessel water systems used for the storage and distribution of water which has met the requirements of § 1240.80 of this chapter.

(a) The potable water system, including filling hose and lines, pumps, tanks, and distributing pipes, shall be separate and distinct from other water systems and shall be used for no other purposes.

(b) All potable water tanks shall be independent of any tanks holding nonpotable water or other liquid. All potable water tanks shall be independent of the shell of the ship unless (1) the bottom of the tank is at least 2 feet above the maximum load water line, (2) the seams in the shell are continuously welded, and (3) there are no rivets in that part of the shell which forms a side of a tank. A deck may be used as the top of a tank provided there are no access or inspection openings or rivets therein, and the seams are continuously welded. No toilet or urinal shall be installed immediately above that part of the deck which forms the top of a tank. All potable water tanks shall be located at a sufficient height above the bilge to allow for draining and to prevent submergence in bilge water.

(c) Each potable water tank shall be provided with a means of drainage and, if it is equipped with a manhole, overflow, vent, or a device for measuring depth of water, provision shall be made

to prevent entrance into the tank of any contaminating substance. No deck or sanitary drain or pipe carrying any nonpotable water or liquid shall be permitted to pass through the tank.

(d) Tanks and piping shall bear clear marks of identification.

(e) There shall be no backflow or cross connection between potable water systems and any other systems. Pipes and fittings conveying potable water to any fixture, apparatus, or equipment shall be installed in such way that backflow will be prevented. Waste pipes from any part of the potable water system, including treatment devices, discharging to a drain, shall be suitably protected against backflow.

(f) Water systems shall be cleaned, disinfected, and flushed whenever the Commissioner of Food and Drugs shall find such treatment necessary to prevent the introduction, transmission, or spread of communicable diseases.

[40 FR 5624, Feb. 6, 1975, as amended at 48 FR 11432, Mar. 18, 1983]

#### § 1250.83 Storage of water prior to treatment.

The following requirements with respect to the storage of water on vessels prior to treatment must be met in order to obtain approval of treatment facilities under § 1240.90 of this chapter.

(a) The tank, whether independent or formed by the skin of the ship, deck, tank top, or partitions common with other tanks, shall be free of apparent leakage.

(b) No sanitary drain shall pass through the tank.

(c) The tank shall be adequately protected against both the backflow and discharge into it of bilge or highly contaminated water.

#### § 1250.84 Water in galleys and medical care spaces.

(a) Potable water, hot and cold, shall be available in the galley and pantry except that, when potable water storage is inadequate, nonpotable water may be piped to the galley for deck washing and in connection with garbage disposal. Any tap discharging nonpotable water which is installed for deck washing purposes shall not be more than 18 inches above the deck and

**§ 1250.85**

shall be distinctly marked "For deck washing only".

(b) In the case of existing vessels on which heat treated wash water has been used for the washing of utensils prior to the effective date of the regulations in this part, such water may continue to be so used provided controls are employed to insure the heating of all water to at least 170 °F before discharge from the heater.

(c) Potable water, hot and cold, shall be available in medical care spaces for hand-washing and for medical care purposes excluding hydrotherapy.

**§ 1250.85 Drinking fountains and coolers; ice; constant temperature bottles.**

(a) Drinking fountains and coolers shall be constructed of impervious, nonoxidizing material, and shall be so designed and constructed as to be easily cleaned. The jet of a drinking fountain shall be slanting and the orifice of the jet shall be protected by a guard in such a manner as to prevent contamination thereof by droppings from the mouth. The orifice of such a jet shall be located a sufficient distance above the rim of the basin to prevent back-flow.

(b) Ice shall not be permitted to come in contact with water in coolers or constant temperature bottles.

(c) Constant temperature bottles and other containers used for storing or dispensing potable water shall be kept clean at all times and shall be subjected to effective bactericidal treatment after each occupancy of the space served and at intervals not exceeding one week.

**§ 1250.86 Water for making ice.**

Only potable water shall be piped into a freezer for making ice for drinking and culinary purposes.

**§ 1250.87 Wash water.**

Where systems installed on vessels for wash water, as defined in §1250.3(n), do not comply with the requirements of a potable water system, prescribed in §1250.82, they shall be constructed so as to minimize the possibility of the water therein being contaminated. The storage tanks shall comply with the requirements of §1250.83, and the dis-

**21 CFR Ch. I (4-1-20 Edition)**

tribution system shall not be cross connected to a system carrying water of a lower sanitary quality. All faucets shall be labeled "Unfit for drinking".

**§ 1250.89 Swimming pools.**

(a) Fill and draw swimming pools shall not be installed or used.

(b) Swimming pools of the recirculation type shall be equipped so as to provide complete circulation, replacement, and filtration of the water in the pool every six hours or less. Suitable means of chlorination and, if necessary, other treatment of the water shall be provided to maintain the residual chlorine in the pool water at not less than 0.4 part per million and the pH (a measure of the hydrogen ion concentration) not less than 7.0.

(c) Flowing-through types of salt water pools shall be so operated that complete circulation and replacement of the water in the pool will be effected every 6 hours or less. The water delivery pipe to the pool shall be independent of all other pipes and shall originate at a point where maximum flushing of the pump and pipe line is effected after leaving polluted waters.

**§ 1250.90 Toilets and lavatories.**

Toilet and lavatory equipment and spaces shall be maintained in a clean condition.

**§ 1250.93 Discharge of wastes.**

Vessels operating on fresh water lakes or rivers shall not discharge sewage, or ballast or bilge water, within such areas adjacent to domestic water intakes as are designated by the Commissioner of Food and Drugs.

CROSS REFERENCE: For Environmental Protection Agency's regulations for vessel sanitary discharges as related to authority under the Federal Water Pollution Control Act, as amended (33 U.S.C. 1314 *et seq.*), see 40 CFR part 140.

[40 FR 5624, Feb. 6, 1975, as amended at 48 FR 11432, Mar. 18, 1983]

**§ 1250.95 Insect control.**

Vessels shall be maintained free of infestation by flies, mosquitoes, fleas, lice, and other insects known to be vectors in the transmission of communicable diseases, through the use of

screening, insecticides, and other generally accepted methods of insect control.

**§ 1250.96 Rodent control.**

Vessels shall be maintained free of rodent infestation through the use of traps, poisons, and other generally accepted methods of rodent control.

**PARTS 1251–1269 [RESERVED]**

**PART 1270—HUMAN TISSUE  
INTENDED FOR TRANSPLANTATION**

**Subpart A—General Provisions**

Sec.

1270.1 Scope.

1270.3 Definitions.

**Subpart B—Donor Screening and Testing**

1270.21 Determination of donor suitability for human tissue intended for transplantation.

**Subpart C—Procedures and Records**

1270.31 Written procedures.

1270.33 Records, general requirements.

1270.35 Specific records.

**Subpart D—Inspection of Tissue  
Establishments**

1270.41 Inspections.

1270.42 Human tissue offered for import.

1270.43 Retention, recall, and destruction of human tissue.

AUTHORITY: 42 U.S.C. 216, 243, 264, 271.

SOURCE: 62 FR 40444, July 29, 1997, unless otherwise noted.

**Subpart A—General Provisions**

**§ 1270.1 Scope.**

(a) The regulations in this part apply to human tissue and to establishments or persons engaged in the recovery, screening, testing, processing, storage, or distribution of human tissue.

(b) Regulations in this chapter as they apply to drugs, biologics, devices, or other FDA-regulated commodities do not apply to human tissue, except as specified in this part.

(c) Regulations in this chapter do not apply to autologous human tissue.

(d) Regulations in this chapter do not apply to hospitals or other clinical fa-

cilities that receive and store human tissue only for transplantation within the same facility.

**§ 1270.3 Definitions.**

(a) *Act* for the purpose of this part means the Public Health Service Act, section 361 (42 U.S.C. 264).

(b) *Blood component* means any part of a single-donor unit of blood separated by physical or mechanical means.

(c) *Colloid* means a protein or polysaccharide solution that can be used to increase or maintain osmotic (oncotic) pressure in the intravascular compartment such as albumin, dextran, hetastarch; or certain blood components, such as plasma and platelets.

(d) *Contract services* are those functions pertaining to the recovery, screening, testing, processing, storage, or distribution of human tissue that another establishment agrees to perform for a tissue establishment.

(e) *Crystalloid* means a balanced salt and/or glucose solution used for electrolyte replacement or to increase intravascular volume such as saline, Ringer's lactate solution, or 5 percent dextrose in water.

(f) *Distribution* includes any transfer or shipment of human tissue (including importation or exportation), whether or not such transfer or shipment is entirely intrastate and whether or not possession of the tissue is taken.

(g) *Donor* means a human being, living or dead, who is the source of tissue for transplantation.

(h) *Donor medical history interview* means a documented dialogue with an individual or individuals who would be knowledgeable of the donor's relevant medical history and social behavior; such as the donor if living, the next of kin, the nearest available relative, a member of the donor's household, other individual with an affinity relationship, and/or the primary treating physician. The relevant social history includes questions to elicit whether or not the donor met certain descriptions or engaged in certain activities or behaviors considered to place such an individual at increased risk for HIV and hepatitis.

(i) *Establishment* means any facility under one management including all locations, that engages in the recovery,

screening, testing, processing, storage, or distribution of human tissue intended for transplantation.

(j) *Human tissue*, for the purpose of this part means any tissue derived from a human body and recovered before May 25, 2005, which:

(1) Is intended for transplantation to another human for the diagnosis, cure, mitigation, treatment, or prevention of any condition or disease;

(2) Is recovered, processed, stored, or distributed by methods that do not change tissue function or characteristics;

(3) Is not currently regulated as a human drug, biological product, or medical device;

(4) Excludes kidney, liver, heart, lung, pancreas, or any other vascularized human organ; and

(5) Excludes semen or other reproductive tissue, human milk, and bone marrow.

(k) *Importer of record* means the person, establishment or their representative responsible for making entry of imported goods in accordance with all laws affecting such importation.

(l) *Legislative consent* means relating to any of the laws of the various States that allow the medical examiner or coroner to procure corneal tissue in the absence of consent of the donor's next-of-kin.

(m) *Person* includes an individual, partnership, corporation, association, or other legal entity.

(n) *Physical assessment* means a limited autopsy or recent antemortem or postmortem physical examination of the donor to assess for any signs of HIV and hepatitis infection or signs suggestive of any risk factor for such infections.

(o) *Plasma dilution* means a decrease in the concentration of the donor's plasma proteins and circulating antigens or antibodies resulting from the transfusion of blood or blood components and/or infusion of fluids.

(p) *Processing* means any activity performed on tissue, other than tissue recovery, including preparation, preservation for storage, and/or removal from storage to assure the quality and/or sterility of human tissue. Processing includes steps to inactivate and remove adventitious agents.

(q) *Quarantine* means the identification of human tissue as not suitable for transplantation, including human tissue that has not yet been characterized as being suitable for transplantation. Quarantine includes the storage of such tissue in an area clearly identified for such use, or other procedures, such as automated designation, for prevention of release of such tissue for transplantation.

(r) *Reconstituted blood* means the extracorporeal resuspension of a blood unit labeled as "Red Blood Cells" by the addition of colloids and/or crystalloids to produce a hematocrit in the normal range.

(s) *Recovery* means the obtaining from a donor of tissue that is intended for use in human transplantation.

(t) *Relevant medical records* means a collection of documents including a donor medical history interview, a physical assessment of the donor, laboratory test results, medical records, existing coroner and autopsy reports, or information obtained from any source or records which may pertain to donor suitability regarding high risk behaviors, clinical signs and symptoms for HIV and hepatitis, and treatments related to medical conditions suggestive of such risk.

(u) *Responsible person* means a person who is authorized to perform designated functions for which he or she is trained and qualified.

(v) *Storage* means holding tissue.

(w) *Summary of records* means a condensed version of the required testing and screening records that contains the identity of the testing laboratory, the listing and interpretation of all required infectious disease tests, and a listing of the documents reviewed as part of the relevant medical records, and the name of the person or establishment determining the suitability of the human tissue for transplantation.

(x) *Vascularized* means containing the original blood vessels which are intended to carry blood after transplantation.

[62 FR 40444, July 29, 1997, as amended at 69 FR 68680, Nov. 24, 2004]

### Subpart B—Donor Screening and Testing

#### § 1270.21 Determination of donor suitability for human tissue intended for transplantation.

(a) Donor specimens shall be tested for the following communicable viruses, using Food and Drug Administration (FDA) licensed donor screening tests in accordance with manufacturers' instructions:

(1) Human immunodeficiency virus, Type 1 (e.g., FDA licensed screening test for anti-HIV-1);

(2) Human immunodeficiency virus, Type 2 (e.g., FDA licensed screening test for anti-HIV-2);

(3) Hepatitis B (e.g., FDA licensed screening test for HBsAg); and

(4) Hepatitis C (e.g., FDA licensed screening test for anti-HCV).

(b) In the case of a neonate, the mother's specimen is acceptable for testing.

(c) Such infectious disease testing shall be performed by a laboratory certified under the Clinical Laboratories Improvement Amendments of 1988 (CLIA).

(d) Human tissue shall be accompanied by records indicating that the donor's specimen has been tested and found negative using FDA licensed screening tests for HIV-1, HIV-2, hepatitis B, and hepatitis C. FDA licensed screening tests labeled for cadaveric specimens must be used when available.

(e) Human tissue for transplantation shall be accompanied by a summary of records or copies of the original records of the donor's relevant medical records as defined in §1270.3(t) which documents freedom from risk factors for and clinical evidence of hepatitis B, hepatitis C, or HIV infection. There shall be a responsible person designated and identified in the original record and summary of records as having made the determination that the human tissue is suitable for transplantation.

(f) Determination by the responsible person that a donor of human tissue intended for transplantation is suitable shall include ascertainment of the donor's identity, and accurately recorded relevant medical records (as defined in

§1270.3(t)) which documents freedom from risk factors for and clinical evidence of hepatitis B, hepatitis C, and HIV infection.

(g) For corneal tissue procured under legislative consent where a donor medical history screening interview has not occurred, a physical assessment of the donor is required and other available information shall be reviewed. The corneal tissue shall be accompanied by the summary of records documenting that the corneal tissue was determined to be suitable for transplantation in the absence of the donor medical history interview. Corneal tissue procured under legislative consent shall be documented as such in the summary of records.

(h) Human tissue shall be determined to be not suitable for transplantation if from:

(1) A donor whose specimen has tested repeatedly reactive on a screening test for HIV, hepatitis B, or hepatitis C;

(2) A donor where blood loss is known or suspected to have occurred and transfusion/infusion of more than 2,000 milliliters (mL) of blood (i.e., whole blood, reconstituted blood, or red blood cells), or colloids within 48 hours; or more than 2,000 mL of crystalloids within 1 hour; or any combination thereof prior to the collection of a blood specimen from the tissue donor for testing, unless:

(i) A pretransfusion or preinfusion blood specimen from the tissue donor is available for infectious disease testing; or

(ii) An algorithm is utilized that evaluates the volumes administered in the 48 hours prior to collecting the blood specimen from the tissue donor to ensure that there has not been plasma dilution sufficient to affect test results; or

(3) A donor who is 12 years of age or less and has been transfused or infused at all, unless:

(i) A pretransfusion or preinfusion blood specimen from the tissue donor is available for infectious disease testing; or

(ii) An algorithm is utilized that evaluates the volumes administered in the 48 hours prior to collecting the blood specimen from the tissue donor

to ensure that there has not been plasma dilution sufficient to affect test results.

### Subpart C—Procedures and Records

#### § 1270.31 Written procedures.

(a) There shall be written procedures prepared and followed for all significant steps in the infectious disease testing process under § 1270.21 which shall conform to the manufacturers' instructions for use contained in the package inserts for the required tests. These procedures shall be readily available to the personnel in the area where the procedures are performed unless impractical. Any deviation from the written procedures shall be recorded and justified.

(b) There shall be written procedures prepared and followed for all significant steps for obtaining, reviewing, and assessing the relevant medical records of the donor as provided in § 1270.21. Such procedures shall be readily available to personnel who may perform the procedures. Any deviation from the written procedures shall be recorded and justified.

(c) There shall be written procedures prepared and followed for designating and identifying quarantined tissue.

(d) There shall be written procedures prepared, validated, and followed for prevention of infectious disease contamination or cross-contamination by tissue during processing.

(e) In conformity with this section, any facility may use current standard written procedures such as those in a technical manual prepared by another organization, provided the procedures are consistent with and at least as stringent as the requirements of this part.

#### § 1270.33 Records, general requirements.

(a) Records shall be maintained concurrently with the performance of each significant step required in this part in the performance of infectious disease screening and testing of donors of human tissue. All records shall be accurate, indelible, and legible. The records shall identify the person performing the work, the dates of the var-

ious entries, and shall be as detailed as necessary to provide a complete history of the work performed and to relate the records to the particular tissue involved.

(b) All human tissue shall be quarantined until the following criteria for donor suitability are satisfied:

(1) All infectious disease testing under § 1270.21 has been completed, reviewed by the responsible person, and found to be negative; and

(2) Donor screening has been completed, reviewed by the responsible person, and determined to assure freedom from risk factors for and clinical evidence of HIV infection, hepatitis B, and hepatitis C.

(c) All human tissue processed or shipped prior to determination of donor suitability must be under quarantine, accompanied by records assuring identification of the donor and indicating that the tissue has not been determined to be suitable for transplantation.

(d) All human tissue determined to be suitable for transplantation must be accompanied by a summary of records, or copies of such original records, documenting that all infectious disease testing and screening under § 1270.21 has been completed, reviewed by the responsible person, and found to be negative, and that the tissue has been determined to be suitable for transplantation.

(e) Human tissue shall be quarantined until the tissue is either determined to be suitable for transplantation or appropriate disposition is accomplished.

(f) All persons or establishments that generate records used in determining the suitability of the donor shall retain such records and make them available for authorized inspection or upon request by FDA. The person(s) or establishment(s) making the determination regarding the suitability of the donor shall retain all records, or true copies of such records required under § 1270.21, including all testing and screening records, and shall make them available for authorized inspection or upon request from FDA. Records that can be retrieved from another location by electronic means meet the requirements of this paragraph.

(g) Records required under this part may be retained electronically, or as original paper records, or as true copies such as photocopies, microfiche, or microfilm, in which case suitable reader and photocopying equipment shall be readily available.

(h) Records shall be retained at least 10 years beyond the date of transplantation if known, distribution, disposition, or expiration, of the tissue, whichever is latest.

[62 FR 40444, July 29, 1997, as amended at 63 FR 16685, Apr. 6, 1998]

#### § 1270.35 Specific records.

Records shall be maintained that include, but are not limited to:

(a) Documentation of results and interpretation of all required infectious disease tests;

(b) Information on the identity and relevant medical records of the donor, as required by § 1270.21(e) in English or, if in another language translated to English and accompanied by a statement of authenticity by the translator which specifically identifies the translated document;

(c) Documentation of the receipt and/or distribution of human tissue; and

(d) Documentation of the destruction or other disposition of human tissue.

### Subpart D—Inspection of Tissue Establishments

#### § 1270.41 Inspections.

(a) An establishment covered by these regulations in this part, including any location performing contract services, shall permit an authorized inspector of the Food and Drug Administration (FDA) to make at any reasonable time and in a reasonable manner such inspection of the establishment, its facilities, equipment, processes, products, and records as may be necessary to determine compliance with the provisions of this part. Such inspections may be made with or without notice and will ordinarily be made during regular business hours.

(b) The frequency of inspection will be at the agency's discretion.

(c) The inspector shall call upon a responsible person of the establishment and may question the personnel of the

establishment as the inspector deems necessary.

(d) The inspector may review and copy any records required to be kept pursuant to part 1270.

(e) The public disclosure of records containing the name or other positive identification of donors or recipients of human tissue will be handled in accordance with FDA's procedures on disclosure of information as set forth in 21 CFR part 20 of this chapter.

#### § 1270.42 Human tissue offered for import.

(a) When human tissue is offered for entry, the importer of record must notify the director of the district of the Food and Drug Administration having jurisdiction over the port of entry through which the tissue is imported or offered for import, or such officer of the district as the director may designate to act in his or her behalf in administering and enforcing this part.

(b) Human tissue offered for import must be quarantined until the human tissue is released by FDA.

#### § 1270.43 Retention, recall, and destruction of human tissue.

(a) Upon a finding that human tissue may be in violation of the regulations in this part, an authorized Food and Drug Administration (FDA) representative may:

(1) Serve upon the person who distributed the tissue a written order that the tissue be recalled and/or destroyed, as appropriate, and upon persons in possession of the tissue that the tissue shall be retained until it is recalled by the distributor, destroyed, or disposed of as agreed by FDA, or the safety of the tissue is confirmed; and/or

(2) Take possession of and/or destroy the violative tissue.

(b) The written order will ordinarily provide that the human tissue be recalled and/or destroyed within 5 working days from the date of receipt of the order and will state with particularity the facts that justify the order.

(c) After receipt of an order under this part, the person in possession of the human tissue shall not distribute or dispose of the tissue in any manner except to recall and/or destroy the tissue consistent with the provisions of

**Pt. 1271**

**21 CFR Ch. I (4–1–20 Edition)**

the order, under the supervision of an authorized official of FDA.

(d) In lieu of paragraphs (b) and (c) of this section, other arrangements for assuring the proper disposition of the tissue may be agreed upon by the person receiving the written order and an authorized official of FDA. Such arrangements may include providing FDA with records or other written information that adequately assure that the tissue has been recovered, screened, tested, processed, stored, and distributed in conformance with part 1270.

(e) Within 5 working days of receipt of a written order for retention, recall, and/or destruction of tissue (or within 5 working days of the agency's possession of such tissue), the recipient of the written order or prior possessor of such tissue shall request a hearing on the matter in accordance with part 16 of this chapter. The order for destruction will be held in abeyance pending resolution of the hearing request.

**PART 1271—HUMAN CELLS, TISSUES, AND CELLULAR AND TISSUE-BASED PRODUCTS**

**Subpart A—General Provisions**

Sec.

- 1271.1 What are the purpose and scope of this part?
- 1271.3 How does FDA define important terms in this part?
- 1271.10 Are my HCT/P's regulated solely under section 361 of the PHS Act and the regulations in this part, and if so what must I do?
- 1271.15 Are there any exceptions from the requirements of this part?
- 1271.20 If my HCT/P's do not meet the criteria in §1271.10, and I do not qualify for any of the exceptions in §1271.15, what regulations apply?

**Subpart B—Procedures for Registration and Listing**

- 1271.21 When do I register, submit an HCT/P list, and submit updates?
- 1271.22 How do I register and submit an HCT/P list?
- 1271.23 How is a waiver from the electronic format requirements requested?
- 1271.25 What information is required for establishment registration and HCT/P listing?
- 1271.26 When must I amend my establishment registration?

1271.27 Will FDA assign me a registration number?

1271.37 Will establishment registrations and HCT/P listings be available for inspection, and how do I request information on registrations and listings?

**Subpart C—Donor Eligibility**

- 1271.45 What requirements does this subpart contain?
- 1271.47 What procedures must I establish and maintain?
- 1271.50 How do I determine whether a donor is eligible?
- 1271.55 What records must accompany an HCT/P after the donor-eligibility determination is complete; and what records must I maintain?
- 1271.60 What quarantine and other requirements apply before the donor-eligibility determination is complete?
- 1271.65 How do I store an HCT/P from a donor determined to be ineligible, and what uses of the HCT/P are not prohibited?
- 1271.75 How do I screen a donor?
- 1271.80 What are the general requirements for donor testing?
- 1271.85 What donor testing is required for different types of cells and tissues?
- 1271.90 Are there exceptions from the requirement of determining donor eligibility, and what labeling requirements apply?

**Subpart D—Current Good Tissue Practice**

- 1271.145 Prevention of the introduction, transmission, or spread of communicable diseases.
- 1271.150 Current good tissue practice requirements.
- 1271.155 Exemptions and alternatives.
- 1271.160 Establishment and maintenance of a quality program.
- 1271.170 Personnel.
- 1271.180 Procedures.
- 1271.190 Facilities.
- 1271.195 Environmental control and monitoring.
- 1271.200 Equipment.
- 1271.210 Supplies and reagents.
- 1271.215 Recovery.
- 1271.220 Processing and process controls.
- 1271.225 Process changes.
- 1271.230 Process validation.
- 1271.250 Labeling controls.
- 1271.260 Storage.
- 1271.265 Receipt, predistribution shipment, and distribution of an HCT/P.
- 1271.270 Records.
- 1271.290 Tracking.
- 1271.320 Complaint file.



## Food and Drug Administration, HHS

## § 1271.3

### Subpart E—Additional Requirements for Establishments Described in § 1271.10

- 1271.330 Applicability.
- 1271.350 Reporting.
- 1271.370 Labeling.

### Subpart F—Inspection and Enforcement of Establishments Described in § 1271.10

- 1271.390 Applicability.
- 1271.400 Inspections.
- 1271.420 HCT/Ps offered for import.
- 1271.440 Orders of retention, recall, destruction, and cessation of manufacturing.

AUTHORITY: 42 U.S.C. 216, 243, 263a, 264, 271.

SOURCE: 66 FR 5466, Jan. 19, 2001, unless otherwise noted.

### Subpart A—General Provisions

#### § 1271.1 What are the purpose and scope of this part?

(a) *Purpose.* The purpose of this part, in conjunction with §§ 207.9(a)(5), 210.1(c), 210.2, 807.20(d), and 820.1(a) of this chapter, is to create an electronic registration and listing system for establishments that manufacture human cells, tissues, and cellular and tissue-based products (HCT/P's) and to establish donor-eligibility, current good tissue practice, and other procedures to prevent the introduction, transmission, and spread of communicable diseases by HCT/P's.

(b) *Scope.* (1) If you are an establishment that manufactures HCT/P's that are regulated solely under the authority of section 361 of the Public Health Service Act (the PHS Act), this part requires you to register and list your HCT/P's with the Food and Drug Administration's (FDA's) Center for Biologics Evaluation and Research and to comply with the other requirements contained in this part, whether or not the HCT/P enters into interstate commerce. Those HCT/P's that are regulated solely under the authority of section 361 of the PHS Act are described in § 1271.10.

(2) If you are an establishment that manufactures HCT/P's that are regulated as drugs, devices and/or biological products under section 351 of the PHS Act and/or the Federal Food, Drug, and Cosmetic Act, §§ 207.9(a)(5) and 807.20(d) of this chapter require you to register and list your HCT/P's fol-

lowing the procedures in part 207 (if a drug and/or biological product) of this chapter or part 807 (if a device) of this chapter. Sections 210.1(c), 210.2, 211.1(b), and 820.1(a) of this chapter require you to comply with the donor-eligibility procedures in subpart C of this part and the current good tissue practice procedures in subpart D of this part, in addition to all other applicable regulations.

[66 FR 5466, Jan. 19, 2001, as amended at 69 FR 29829, May 25, 2004; 81 FR 60223, Aug. 31, 2016]

#### § 1271.3 How does FDA define important terms in this part?

The following definitions apply only to this part:

(a) *Autologous use* means the implantation, transplantation, infusion, or transfer of human cells or tissue back into the individual from whom the cells or tissue were recovered.

(b) *Establishment* means a place of business under one management, at one general physical location, that engages in the manufacture of human cells, tissues, and cellular and tissue-based products. "Establishment" includes:

(1) Any individual, partnership, corporation, association, or other legal entity engaged in the manufacture of human cells, tissues, and cellular and tissue-based products; and

(2) Facilities that engage in contract manufacturing services for a manufacturer of human cells, tissues, and cellular and tissue-based products.

(c) *Homologous use* means the repair, reconstruction, replacement, or supplementation of a recipient's cells or tissues with an HCT/P that performs the same basic function or functions in the recipient as in the donor.

(d) *Human cells, tissues, or cellular or tissue-based products (HCT/Ps)* means articles containing or consisting of human cells or tissues that are intended for implantation, transplantation, infusion, or transfer into a human recipient. Examples of HCT/Ps include, but are not limited to, bone, ligament, skin, dura mater, heart valve, cornea, hematopoietic stem/progenitor cells derived from peripheral and cord blood, manipulated autologous chondrocytes, epithelial

§ 1271.3

cells on a synthetic matrix, and semen or other reproductive tissue. The following articles are not considered HCT/Ps:

(1) Vascularized human organs for transplantation;

(2) Whole blood or blood components or blood derivative products subject to listing under parts 607 and 207 of this chapter, respectively;

(3) Secreted or extracted human products, such as milk, collagen, and cell factors; except that semen is considered an HCT/P;

(4) Minimally manipulated bone marrow for homologous use and not combined with another article (except for water, crystalloids, or a sterilizing, preserving, or storage agent, if the addition of the agent does not raise new clinical safety concerns with respect to the bone marrow);

(5) Ancillary products used in the manufacture of HCT/P;

(6) Cells, tissues, and organs derived from animals other than humans; and

(7) In vitro diagnostic products as defined in § 809.3(a) of this chapter.

(8) Blood vessels recovered with an organ, as defined in 42 CFR 121.2, that are intended for use in organ transplantation and labeled "For use in organ transplantation only."

(e) *Manufacture means*, but is not limited to, any or all steps in the recovery, processing, storage, labeling, packaging, or distribution of any human cell or tissue, and the screening or testing of the cell or tissue donor.

(f) *Minimal manipulation means*:

(1) For structural tissue, processing that does not alter the original relevant characteristics of the tissue relating to the tissue's utility for reconstruction, repair, or replacement; and

(2) For cells or nonstructural tissues, processing that does not alter the relevant biological characteristics of cells or tissues.

(g) *Transfer* means the placement of human reproductive cells or tissues into a human recipient.

(h) *Biohazard legend* appears on the label as follows and is used to mark HCT/Ps that present a known or suspected relevant communicable disease risk.

21 CFR Ch. I (4-1-20 Edition)

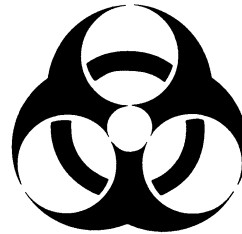

BIOHAZARD

(i) *Blood component* means a product containing a part of human blood separated by physical or mechanical means.

(j) *Colloid* means:

(1) A protein or polysaccharide solution, such as albumin, dextran, or hetastarch, that can be used to increase or maintain osmotic (oncotic) pressure in the intravascular compartment; or

(2) Blood components such as plasma and platelets.

(k) *Crystalloid* means an isotonic salt and/or glucose solution used for electrolyte replacement or to increase intravascular volume, such as saline solution, Ringer's lactate solution, or 5 percent dextrose in water.

(l) *Directed reproductive donor* means a donor of reproductive cells or tissue (including semen, oocytes, and embryos to which the donor contributed the spermatozoa or oocyte) to a specific recipient, and who knows and is known by the recipient before donation. The term directed reproductive donor does not include a sexually intimate partner under § 1271.90.

(m) *Donor* means a person, living or dead, who is the source of cells or tissue for an HCT/P.

(n) *Donor medical history interview means* a documented dialog about the donor's medical history and relevant social behavior, including activities, behaviors, and descriptions considered to increase the donor's relevant communicable disease risk:

(1) With the donor, if the donor is living and able to participate in the interview, or

(2) If not, with an individual or individuals able to provide the information sought in the interview (e.g., the donor's next-of-kin, the nearest available relative, a member of the donor's

household, an individual with an affinity relationship, and/or the primary treating physician).

(o) *Physical assessment of a cadaveric donor* means a limited autopsy or recent antemortem or postmortem physical examination of the donor to assess for signs of a relevant communicable disease and for signs suggestive of any risk factor for a relevant communicable disease.

(p) *Plasma dilution* means a decrease in the concentration of the donor's plasma proteins and circulating antigens or antibodies resulting from the transfusion of blood or blood components and/or infusion of fluids.

(q) *Quarantine* means the storage or identification of an HCT/P, to prevent improper release, in a physically separate area clearly identified for such use, or through use of other procedures, such as automated designation.

(r) *Relevant communicable disease agent or disease* means:

(1)(i) For all human cells and tissues, a communicable disease or disease agent listed as follows:

(A) Human immunodeficiency virus, types 1 and 2;

(B) Hepatitis B virus;

(C) Hepatitis C virus;

(D) Human transmissible spongiform encephalopathy, including Creutzfeldt-Jakob disease; and

(E) *Treponema pallidum*.

(ii) For viable, leukocyte-rich cells and tissues, a cell-associated disease agent or disease listed as follows:

(A) Human T-lymphotropic virus, type I; and

(B) Human T-lymphotropic virus, type II.

(iii) For reproductive cells or tissues, a disease agent or disease of the genitourinary tract listed as follows:

(A) *Chlamydia trachomatis*; and

(B) *Neisseria gonorrhoea*.

(2) A disease agent or disease not listed in paragraph (r)(1) of this section:

(i) For which there may be a risk of transmission by an HCT/P, either to the recipient of the HCT/P or to those people who may handle or otherwise come in contact with it, such as medical personnel, because the disease agent or disease:

(A) Is potentially transmissible by an HCT/P and

(B) Either of the following applies:

(1) The disease agent or disease has sufficient incidence and/or prevalence to affect the potential donor population, or

(2) The disease agent or disease may have been released accidentally or intentionally in a manner that could place potential donors at risk of infection;

(ii) That could be fatal or life-threatening, could result in permanent impairment of a body function or permanent damage to body structure, or could necessitate medical or surgical intervention to preclude permanent impairment of body function or permanent damage to a body structure; and

(iii) For which appropriate screening measures have been developed and/or an appropriate screening test for donor specimens has been licensed, approved, or cleared for such use by FDA and is available.

(s) *Relevant medical records* means a collection of documents that includes a current donor medical history interview; a current report of the physical assessment of a cadaveric donor or the physical examination of a living donor; and, if available, the following:

(1) Laboratory test results (other than results of testing for relevant communicable disease agents required under this subpart);

(2) Medical records;

(3) Coroner and autopsy reports; and

(4) Records or other information received from any source pertaining to risk factors for relevant communicable disease (e.g., social behavior, clinical signs and symptoms of relevant communicable disease, and treatments related to medical conditions suggestive of risk for relevant communicable disease).

(t) *Responsible person* means a person who is authorized to perform designated functions for which he or she is trained and qualified.

(u) *Urgent medical need* means that no comparable HCT/P is available and the recipient is likely to suffer death or serious morbidity without the HCT/P.

(v) *Act* means the Federal Food, Drug, and Cosmetic Act.

(w) *PHS Act* means the Public Health Service Act.

(x) *FDA* means the Food and Drug Administration.

(y) *Adverse reaction* means a noxious and unintended response to any HCT/P for which there is a reasonable possibility that the HCT/P caused the response.

(z) *Available for distribution* means that the HCT/P has been determined to meet all release criteria.

(aa) *Complaint* means any written, oral, or electronic communication about a distributed HCT/P that alleges:

(1) That an HCT/P has transmitted or may have transmitted a communicable disease to the recipient of the HCT/P; or

(2) Any other problem with an HCT/P relating to the potential for transmission of communicable disease, such as the failure to comply with current good tissue practice.

(bb) *Distribution* means any conveyance or shipment (including importation and exportation) of an HCT/P that has been determined to meet all release criteria, whether or not such conveyance or shipment is entirely intrastate. If an entity does not take physical possession of an HCT/P, the entity is not considered a distributor.

(cc) *Establish and maintain* means define, document (in writing or electronically), and implement; then follow, review, and, as needed, revise on an ongoing basis.

(dd) *HCT/P deviation* means an event:

(1) That represents a deviation from applicable regulations in this part or from applicable standards or established specifications that relate to the prevention of communicable disease transmission or HCT/P contamination; or

(2) That is an unexpected or unforeseeable event that may relate to the transmission or potential transmission of a communicable disease or may lead to HCT/P contamination.

(ee) *Importer of record* means the person, establishment, or its representative responsible for making entry of imported goods in accordance with all laws affecting such importation.

(ff) *Processing* means any activity performed on an HCT/P, other than recovery, donor screening, donor testing, storage, labeling, packaging, or distribution, such as testing for micro-

organisms, preparation, sterilization, steps to inactivate or remove adventitious agents, preservation for storage, and removal from storage.

(gg) *Quality audit* means a documented, independent inspection and review of an establishment's activities related to core CGTP requirements. The purpose of a quality audit is to verify, by examination and evaluation of objective evidence, the degree of compliance with those aspects of the quality program under review.

(hh) *Quality program* means an organization's comprehensive system for manufacturing and tracking HCT/Ps in accordance with this part. A quality program is designed to prevent, detect, and correct deficiencies that may lead to circumstances that increase the risk of introduction, transmission, or spread of communicable diseases.

(ii) *Recovery* means obtaining from a human donor cells or tissues that are intended for use in human implantation, transplantation, infusion, or transfer.

(jj) *Storage* means holding HCT/Ps for future processing and/or distribution.

(kk) *Validation* means confirmation by examination and provision of objective evidence that particular requirements can consistently be fulfilled. Validation of a process, or *process validation*, means establishing by objective evidence that a process consistently produces a result or HCT/P meeting its predetermined specifications.

(ll) *Verification* means confirmation by examination and provision of objective evidence that specified requirements have been fulfilled.

(mm) *Importer* means a company or individual in the United States that is the owner, consignee, or recipient, at the time of entry, of the foreign establishment's HCT/P that is imported into the United States.

(nn) *United States agent* means a person residing or maintaining a place of business in the United States whom a foreign establishment designates as its agent. This definition excludes mailboxes, answering machines or services, or other places where an individual

acting as the foreign establishment's agent is not physically present.

[66 FR 5466, Jan. 19, 2001, as amended at 68 FR 3826, Jan. 27, 2004; 69 FR 29829, May 25, 2004; 69 FR 68680, Nov. 24, 2004; 81 FR 60223, Aug. 31, 2016]

**§ 1271.10 Are my HCT/P's regulated solely under section 361 of the PHS Act and the regulations in this part, and if so what must I do?**

(a) An HCT/P is regulated solely under section 361 of the PHS Act and the regulations in this part if it meets all of the following criteria:

(1) The HCT/P is minimally manipulated;

(2) The HCT/P is intended for homologous use only, as reflected by the labeling, advertising, or other indications of the manufacturer's objective intent;

(3) The manufacture of the HCT/P does not involve the combination of the cells or tissues with another article, except for water, crystalloids, or a sterilizing, preserving, or storage agent, provided that the addition of water, crystalloids, or the sterilizing, preserving, or storage agent does not raise new clinical safety concerns with respect to the HCT/P; and

(4) Either:

(i) The HCT/P does not have a systemic effect and is not dependent upon the metabolic activity of living cells for its primary function; or

(ii) The HCT/P has a systemic effect or is dependent upon the metabolic activity of living cells for its primary function, and:

(a) Is for autologous use;

(b) Is for allogeneic use in a first-degree or second-degree blood relative; or

(c) Is for reproductive use.

(b) If you are a domestic or foreign establishment that manufactures an HCT/P described in paragraph (a) of this section:

(1) You must register with FDA;

(2) You must submit to FDA a list of each HCT/P manufactured; and

(3) You must comply with the other requirements contained in this part.

[66 FR 5466, Jan. 19, 2001, as amended at 69 FR 68681, Nov. 24, 2004]

**§ 1271.15 Are there any exceptions from the requirements of this part?**

(a) You are not required to comply with the requirements of this part if you are an establishment that uses HCT/P's solely for nonclinical scientific or educational purposes.

(b) You are not required to comply with the requirements of this part if you are an establishment that removes HCT/P's from an individual and implants such HCT/P's into the same individual during the same surgical procedure.

(c) You are not required to comply with the requirements of this part if you are a carrier who accepts, receives, carries, or delivers HCT/P's in the usual course of business as a carrier.

(d) You are not required to comply with the requirements of this part if you are an establishment that does not recover, screen, test, process, label, package, or distribute, but only receives or stores HCT/P's solely for implantation, transplantation, infusion, or transfer within your facility.

(e) You are not required to comply with the requirements of this part if you are an establishment that only recovers reproductive cells or tissue and immediately transfers them into a sexually intimate partner of the cell or tissue donor.

(f) You are not required to register or list your HCT/P's independently, but you must comply with all other applicable requirements in this part, if you are an individual under contract, agreement, or other arrangement with a registered establishment and engaged solely in recovering cells or tissues and sending the recovered cells or tissues to the registered establishment.

**§ 1271.20 If my HCT/P's do not meet the criteria in § 1271.10, and I do not qualify for any of the exceptions in § 1271.15, what regulations apply?**

If you are an establishment that manufactures an HCT/P that does not meet the criteria set out in § 1271.10(a), and you do not qualify for any of the exceptions in § 1271.15, your HCT/P will be regulated as a drug, device, and/or biological product under the act and/or section 351 of the PHS Act, and applicable regulations in title 21, chapter I.

## § 1271.21

Applicable regulations include, but are not limited to, §§ 207.9(a)(5), 210.1(c), 210.2, 211.1(b), 807.20(d), and 820.1(a) of this chapter, which require you to follow the procedures in subparts C and D of this part.

[66 FR 5466, Jan. 19, 2001, as amended at 81 FR 60223, Aug. 31, 2016]

### Subpart B—Procedures for Registration and Listing

#### § 1271.21 When do I register, submit an HCT/P list, and submit updates?

(a) You must register and submit a list of every HCT/P that your establishment manufactures within 5 days after beginning operations or within 30 days of the effective date of this regulation, whichever is later.

(b) You must update your establishment registration annually in December, except as required by § 1271.26. You may accomplish your annual registration in conjunction with updating your HCT/P list under paragraph (c) of this section.

(c)(i) If no change described in § 1271.25(c) has occurred since you previously submitted an HCT/P list, you are not required to update your listing.

(ii) If a change described in § 1271.25(c) has occurred, you must update your HCT/P listing with the new information:

(a) At the time of the change, or

(b) Each June or December, whichever month occurs first after the change.

[69 FR 68681, Nov. 24, 2004]

#### § 1271.22 How do I register and submit an HCT/P list?

(a) You must use the electronic registration and listing system at <http://www.fda.gov/cber/tissue/tisreg.htm> in accordance with § 1271.25 for:

- (1) Establishment registration,
- (2) HCT/P listings, and
- (3) Updates of registration and HCT/P listing.

(b) FDA will periodically issue guidance on recommended procedures for providing registration and listing information in electronic format (for example, method of transmission, media, file formats, preparation, and organization of files).

## 21 CFR Ch. I (4–1–20 Edition)

(c) You must provide the information under paragraph (a) of this section in accordance with part 11 of this chapter, except for the requirements in § 11.10(b), (c), and (e) and the corresponding requirements in § 11.30.

[81 FR 60223, Aug. 31, 2016]

#### § 1271.23 How is a waiver from the electronic format requirements requested?

(a) You may request a waiver from the requirement in § 1271.22 that information must be provided to FDA in electronic format. Submission of a request for waiver does not excuse timely compliance with the registration and listing requirements. FDA will grant a waiver request if FDA determines that the use of electronic means for submission of registration and listing information is not reasonable for the registrant making the waiver request.

(b) Waiver requests under this section must be submitted in writing and must include the specific reasons why electronic submission is not reasonable for the registrant and a U.S. telephone number and mailing address where FDA can contact the registrant. Waiver requests may be sent to the Center for Biologics Evaluation and Research (CBER), Document Control Center (see addresses in § 600.2 of this chapter).

(c) If FDA grants the waiver request, FDA may limit its duration and will specify terms of the waiver and provide information on how to submit establishment registration, listings, other information, and updates, as applicable.

[81 FR 60224, Aug. 31, 2016]

#### § 1271.25 What information is required for establishment registration and HCT/P listing?

(a) Your establishment registration must include:

- (1) The legal name(s) of the establishment;
- (2) Each physical location, including the street address, telephone number, email address, and the postal service ZIP code of the establishment;
- (3) The name, address, telephone number, email address, and title of the reporting official;

(4) A dated signature by the reporting official affirming that all information contained in the establishment registration and HCT/P listing form is true and accurate, to the best of his or her knowledge.

(5) Each foreign establishment must also submit the name, address, telephone number, and email address of each importer that is known to the establishment, and the name of each person who imports or offers for import such HCT/P to the United States for purposes of importation; and

(6) Each foreign establishment must also submit the name, address, telephone number, and email address of its United States agent.

(i) The United States agent must reside or maintain a place of business in the United States.

(ii) Upon request from FDA, the United States agent must assist FDA in communications with the foreign establishment, respond to questions concerning the foreign establishment's products that are imported or offered for import into the United States, and assist FDA in scheduling inspections of the foreign establishment. If the Agency is unable to contact the foreign establishment directly or expeditiously, FDA may provide information or documents to the United States agent, and such an action is equivalent to providing the same information or documents to the foreign establishment.

(iii) The foreign establishment or the United States agent must report changes in the United States agent's name, address, telephone number, or email address to FDA within 30 calendar days of the change.

(b) Your HCT/P listing must include all HCT/P's (including the established name and the proprietary name) that you recover, process, store, label, package, distribute, or for which you perform donor screening or testing. You must also state whether each HCT/P meets the criteria set out in §1271.10.

(c) Your HCT/P listing update must include:

(1) A list of each HCT/P that you have begun recovering, processing, storing, labeling, packaging, distributing, or for which you have begun donor screening or testing, that has not been included in any list previously

submitted. You must provide all of the information required by §1271.25(b) for each new HCT/P.

(2) A list of each HCT/P formerly listed in accordance with §1271.21(a) for which you have discontinued recovery, processing, storage, labeling, packaging, distribution, or donor screening or testing, including for each HCT/P so listed, the identity by established name and proprietary name, and the date of discontinuance. We request but do not require that you include the reason for discontinuance with this information.

(3) A list of each HCT/P for which a notice of discontinuance was submitted under paragraph (c)(2) of this section and for which you have resumed recovery, processing, storage, labeling, packaging, distribution, or donor screening or testing, including the identity by established name and proprietary name, the date of resumption, and any other information required by §1271.25(b) not previously submitted.

(4) Any material change in any information previously submitted. Material changes include any change in registration and listing information, submitted, such as whether the HCT/P meets the criteria set out in §1271.10.

(d) If your HCT/P is described under §1271.20 and is regulated under a BLA, you must submit the information required under part 207 of this chapter using the procedures under subpart E of part 207.

[66 FR 5466, Jan. 19, 2001, as amended at 81 FR 60224, Aug. 31, 2016]

#### **§ 1271.26 When must I amend my establishment registration?**

If the ownership or location of your establishment changes, or if there is a change in the United States agent's name, address, telephone number, or email address, you must submit an amendment to registration within 30 calendar days of the change.

[81 FR 60224, Aug. 31, 2017]

#### **§ 1271.27 Will FDA assign me a registration number?**

(a) FDA will assign each location a permanent registration number.

(b) FDA acceptance of an establishment registration and HCT/P listing

form does not constitute a determination that an establishment is in compliance with applicable rules and regulations or that the HCT/P is licensed or approved by FDA.

**§ 1271.37 Will establishment registrations and HCT/P listings be available for inspection, and how do I request information on registrations and listings?**

(a) Any registration on Form FDA 3356 filed in paper or electronic format by each establishment will be available for public inspection through the Center for Biologics Evaluation and Research Human Cell and Tissue Establishment Registration—Public Query Web site by using the CBER electronic Web-based application or by going in person to the Food and Drug Administration, Division of Dockets Management Public Reading Room (see address in § 20.120(a) of this chapter). The following information submitted under the HCT/P requirements is illustrative of the type of information that will be available for public disclosure when it is compiled:

- (1) A list of all HCT/P's;
- (2) A list of all HCT/P's manufactured by each establishment;
- (3) A list of all HCT/P's discontinued; and
- (4) All data or information that has already become a matter of public record.

(b) You should direct your other requests for information regarding HCT/P establishment registrations and HCT/P listings to the Food and Drug Administration, Center for Biologics Evaluation and Research, Office of Communication, Outreach and Development, 10903 New Hampshire Ave., Bldg. 71, Rm. 3103, Silver Spring, MD 20993-0002.

[80 FR 18094, Apr. 3, 2015]

**Subpart C—Donor Eligibility**

SOURCE: 69 FR 29830, May 25, 2004, unless otherwise noted.

**§ 1271.45 What requirements does this subpart contain?**

(a) *General.* This subpart sets out requirements for determining donor eligibility, including donor screening and testing. The requirements contained in

this subpart are a component of current good tissue practice (CGTP) requirements. Other CGTP requirements are set out in subpart D of this part.

(b) *Donor-eligibility determination required.* A donor-eligibility determination, based on donor screening and testing for relevant communicable disease agents and diseases, is required for all donors of cells or tissue used in HCT/Ps, except as provided under § 1271.90. In the case of an embryo or of cells derived from an embryo, a donor-eligibility determination is required for both the oocyte donor and the semen donor.

(c) *Prohibition on use.* An HCT/P must not be implanted, transplanted, infused, or transferred until the donor has been determined to be eligible, except as provided under §§ 1271.60(d), 1271.65(b), and 1271.90 of this subpart.

(d) *Applicability of requirements.* If you are an establishment that performs any function described in this subpart, you must comply with the requirements contained in this subpart that are applicable to that function.

[69 FR 29830, May 25, 2004, as amended at 69 FR 68681, Nov. 24, 2004]

**§ 1271.47 What procedures must I establish and maintain?**

(a) *General.* You must establish and maintain procedures for all steps that you perform in testing, screening, determining donor eligibility, and complying with all other requirements of this subpart. Establish and maintain means define, document (in writing or electronically), and implement; then follow, review, and as needed, revise on an ongoing basis. You must design these procedures to ensure compliance with the requirements of this subpart.

(b) *Review and approval.* Before implementation, a responsible person must review and approve all procedures.

(c) *Availability.* Procedures must be readily available to the personnel in the area where the operations to which they relate are performed, or in a nearby area if such availability is impractical.

(d) *Departures from procedures.* You must record and justify any departure from a procedure relevant to preventing risks of communicable disease



transmission at the time of its occurrence. You must not make available for distribution any HCT/P from a donor whose eligibility is determined under such a departure unless a responsible person has determined that the departure does not increase the risks of communicable disease transmission through the use of the HCT/P.

(e) *Standard procedures.* You may adopt current standard procedures, such as those in a technical manual prepared by another organization, provided that you have verified that the procedures are consistent with and at least as stringent as the requirements of this part and appropriate for your operations.

**§ 1271.50 How do I determine whether a donor is eligible?**

(a) *Determination based on screening and testing.* If you are the establishment responsible for making the donor-eligibility determination, you must determine whether a donor is eligible based upon the results of donor screening in accordance with §1271.75 and donor testing in accordance with §§1271.80 and 1271.85. A responsible person, as defined in §1271.3(t), must determine and document the eligibility of a cell or tissue donor.

(b) *Eligible donor.* A donor is eligible under these provisions only if:

(1) Donor screening in accordance with §1271.75 indicates that the donor:

(i) Is free from risk factors for, and clinical evidence of, infection due to relevant communicable disease agents and diseases; and

(ii) Is free from communicable disease risks associated with xenotransplantation; and

(2) The results of donor testing for relevant communicable disease agents in accordance with §§1271.80 and 1271.85 are negative or nonreactive, except as provided in §1271.80(d)(1).

**§ 1271.55 What records must accompany an HCT/P after the donor-eligibility determination is complete; and what records must I retain?**

(a) *Accompanying records.* Once a donor-eligibility determination has been made, the following must accompany the HCT/P at all times:

(1) A distinct identification code affixed to the HCT/P container, e.g., alphanumeric, that relates the HCT/P to the donor and to all records pertaining to the HCT/P and, except in the case of autologous donations, directed reproductive donations, or donations made by first-degree or second-degree blood relatives, does not include an individual's name, social security number, or medical record number;

(2) A statement whether, based on the results of screening and testing, the donor has been determined to be eligible or ineligible; and

(3) A summary of the records used to make the donor-eligibility determination.

(b) *Summary of records.* The summary of records required by paragraph (a)(3) of this section must contain the following information:

(1) A statement that the communicable disease testing was performed by a laboratory:

(i) Certified to perform such testing on human specimens under the Clinical Laboratory Improvement Amendments of 1988 (42 U.S.C. 263a) and 42 CFR part 493; or

(ii) That has met equivalent requirements as determined by the Centers for Medicare and Medicaid Services in accordance with those provisions;

(2) A listing and interpretation of the results of all communicable disease tests performed;

(3) The name and address of the establishment that made the donor-eligibility determination; and

(4) In the case of an HCT/P from a donor who is ineligible based on screening and released under paragraph (b) of §1271.65, a statement noting the reason(s) for the determination of ineligibility.

(c) *Deletion of personal information.* The accompanying records required by this section must not contain the donor's name or other personal information that might identify the donor.

(d) *Record retention requirements.* (1) You must maintain documentation of:

(i) Results and interpretation of all testing for relevant communicable disease agents in compliance with §§1271.80 and 1271.85, as well as the name and address of the testing laboratory or laboratories;

(ii) Results and interpretation of all donor screening for communicable diseases in compliance with §1271.75; and

(iii) The donor-eligibility determination, including the name of the responsible person who made the determination and the date of the determination.

(2) All records must be accurate, indelible, and legible. Information on the identity and relevant medical records of the donor, as defined in §1271.3(s), must be in English or, if in another language, must be retained and translated to English and accompanied by a statement of authenticity by the translator that specifically identifies the translated document.

(3) You must retain required records and make them available for authorized inspection by or upon request from FDA. Records that can be readily retrieved from another location by electronic means are considered “retained.”

(4) You must retain the records pertaining to a particular HCT/P at least 10 years after the date of its administration, or if the date of administration is not known, then at least 10 years after the date of the HCT/P’s distribution, disposition, or expiration, whichever is latest.

[69 FR 29830, May 25, 2004, as amended at 70 FR 29952, May 25, 2005]

**§ 1271.60 What quarantine and other requirements apply before the donor-eligibility determination is complete?**

(a) *Quarantine.* You must keep an HCT/P in quarantine, as defined in §1271.3(q), until completion of the donor-eligibility determination required by §1271.50. You must quarantine semen from anonymous donors until the retesting required under §1271.85(d) is complete.

(b) *Identification of HCT/Ps in quarantine.* You must clearly identify as quarantined an HCT/P that is in quarantine pending completion of a donor-eligibility determination. The quarantined HCT/P must be easily distinguishable from HCT/Ps that are available for release and distribution.

(c) *Shipping of HCT/Ps in quarantine.* If you ship an HCT/P before completion of the donor-eligibility determination, you must keep it in quarantine during

shipment. The HCT/P must be accompanied by records:

(1) Identifying the donor (e.g., by a distinct identification code affixed to the HCT/P container);

(2) Stating that the donor-eligibility determination has not been completed; and

(3) Stating that the product must not be implanted, transplanted, infused, or transferred until completion of the donor-eligibility determination, except under the terms of paragraph (d) of this section.

(d) *Use in cases of urgent medical need.*

(1) This subpart C does not prohibit the implantation, transplantation, infusion, or transfer of an HCT/P from a donor for whom the donor-eligibility determination is not complete if there is a documented urgent medical need for the HCT/P, as defined in §1271.3(u).

(2) If you make an HCT/P available for use under the provisions of paragraph (d)(1) of this section, you must prominently label it “NOT EVALUATED FOR INFECTIOUS SUBSTANCES,” and “WARNING: Advise patient of communicable disease risks.” The following information must accompany the HCT/P:

(i) The results of any donor screening required under §1271.75 that has been completed;

(ii) The results of any testing required under §1271.80 or 1271.85 that has been completed; and

(iii) A list of any screening or testing required under §1271.75, 1271.80 or 1271.85 that has not yet been completed.

(3) If you are the establishment that manufactured an HCT/P used under the provisions of paragraph (d)(1) of this section, you must document that you notified the physician using the HCT/P that the testing and screening were not complete.

(4) In the case of an HCT/P used for an urgent medical need under the provisions of paragraph (d)(1) of this section, you must complete the donor-eligibility determination during or after the use of the HCT/P, and you must inform the physician of the results of the determination.

**§ 1271.65 How do I store an HCT/P from a donor determined to be ineligible, and what uses of the HCT/P are not prohibited?**

(a) *Storage.* If you are the establishment that stores the HCT/P, you must store or identify HCT/Ps from donors who have been determined to be ineligible in a physically separate area clearly identified for such use, or follow other procedures, such as automated designation, that are adequate to prevent improper release until destruction or other disposition of the HCT/P in accordance with paragraph (b) or (c) of this section.

(b) *Limited uses of HCT/P from ineligible donor.* (1) An HCT/P from a donor who has been determined to be ineligible, based on the results of required testing and/or screening, is not prohibited by subpart C of this part from use for implantation, transplantation, infusion, or transfer under the following circumstances:

(i) The HCT/P is for allogeneic use in a first-degree or second-degree blood relative;

(ii) The HCT/P consists of reproductive cells or tissue from a directed reproductive donor, as defined in § 1271.3(l); or

(iii) There is a documented urgent medical need as defined in § 1271.3(u).

(2) You must prominently label an HCT/P made available for use under the provisions of paragraph (b)(1) of this section with the Biohazard legend shown in § 1271.3(h) with the statement “WARNING: Advise patient of communicable disease risks,” and, in the case of reactive test results, “WARNING: Reactive test results for (name of disease agent or disease).” The HCT/P must be accompanied by the records required under § 1271.55.

(3) If you are the establishment that manufactured an HCT/P used under the provisions of paragraph (b)(1) of this section, you must document that you notified the physician using the HCT/P of the results of testing and screening.

(c) *Nonclinical use.* You may make available for nonclinical purposes an HCT/P from a donor who has been determined to be ineligible, based on the results of required testing and/or screening, provided that it is labeled:

(1) “For Nonclinical Use Only” and

(2) With the Biohazard legend shown in § 1271.3(h).

**§ 1271.75 How do I screen a donor?**

(a) *All donors.* Except as provided under § 1271.90, if you are the establishment that performs donor screening, you must screen a donor of cells or tissue by reviewing the donor’s relevant medical records for:

(1) Risk factors for, and clinical evidence of, relevant communicable disease agents and diseases, including:

(i) Human immunodeficiency virus;

(ii) Hepatitis B virus;

(iii) Hepatitis C virus;

(iv) Human transmissible spongiform encephalopathy, including Creutzfeldt-Jakob disease;

(v) *Treponema pallidum*; and

(2) Communicable disease risks associated with xenotransplantation.

(b) *Donors of viable, leukocyte-rich cells or tissue.* In addition to the relevant communicable disease agents and diseases for which screening is required under paragraph (a) of this section, and except as provided under § 1271.90, you must screen the donor of viable, leukocyte-rich cells or tissue by reviewing the donor’s relevant medical records for risk factors for and clinical evidence of relevant cell-associated communicable disease agents and diseases, including Human T-lymphotropic virus.

(c) *Donors of reproductive cells or tissue.* In addition to the relevant communicable disease agents and diseases for which screening is required under paragraphs (a) and (b) of this section, as applicable, and except as provided under § 1271.90, you must screen the donor of reproductive cells or tissue by reviewing the donor’s relevant medical records for risk factors for and clinical evidence of infection due to relevant communicable diseases of the genitourinary tract. Such screening must include screening for the communicable disease agents listed in paragraphs (c)(1) and (c)(2) of this section. However, if the reproductive cells or tissues are recovered by a method that ensures freedom from contamination of the cells or tissue by infectious disease organisms that may be present in the genitourinary tract, then screening for the communicable disease agents listed

§ 1271.80

21 CFR Ch. I (4–1–20 Edition)

in paragraphs (c)(1) and (c)(2) of this section is not required. Communicable disease agents of the genitourinary tract for which you must screen include:

- (1) *Chlamydia trachomatis*; and
- (2) *Neisseria gonorrhoea*.

(d) *Ineligible donors*. You must determine ineligible a donor who is identified as having either of the following:

(1) A risk factor for or clinical evidence of any of the relevant communicable disease agents or diseases for which screening is required under paragraphs (a)(1), (b), or (c) of this section; or

(2) Any communicable disease risk associated with xenotransplantation.

(e) *Abbreviated procedure for repeat donors*. If you have performed a complete donor screening procedure on a living donor within the previous 6 months, you may use an abbreviated donor screening procedure on repeat donations. The abbreviated procedure must determine and document any changes in the donor's medical history since the previous donation that would make the donor ineligible, including relevant social behavior.

[66 FR 5466, Jan. 19, 2001, as amended at 71 FR 14798, Mar. 24, 2006]

**§ 1271.80 What are the general requirements for donor testing?**

(a) *Testing for relevant communicable diseases is required*. To adequately and appropriately reduce the risk of transmission of relevant communicable diseases, and except as provided under § 1271.90, if you are the establishment that performs donor testing, you must test a donor specimen for evidence of infection due to communicable disease agents in accordance with paragraph (c) of this section. You must test for those communicable disease agents specified in § 1271.85. In the case of a donor 1 month of age or younger, you must test a specimen from the birth mother instead of a specimen from the donor.

(b) *Timing of specimen collection*. You must collect the donor specimen for testing at the time of recovery of cells or tissue from the donor; or up to 7 days before or after recovery, except:

(1) For donors of peripheral blood stem/progenitor cells, bone marrow (if

not excepted under § 1271.3(d)(4)), or oocytes, you may collect the donor specimen for testing up to 30 days before recovery; or

(2) In the case of a repeat semen donor from whom a specimen has already been collected and tested, and for whom retesting is required under § 1271.85(d), you are not required to collect a donor specimen at the time of each donation.

(c) *Tests*. You must test using appropriate FDA-licensed, approved, or cleared donor screening tests, in accordance with the manufacturer's instructions, to adequately and appropriately reduce the risk of transmission of relevant communicable disease agents or diseases; however, until such time as appropriate FDA-licensed, approved, or cleared donor screening tests for *Chlamydia trachomatis* and for *Neisseria gonorrhoea* are available, you must use FDA-licensed, approved, or cleared tests labeled for the detection of those organisms in an asymptomatic, low-prevalence population. You must use a test specifically labeled for cadaveric specimens instead of a more generally labeled test when applicable and when available. Required testing under this section must be performed by a laboratory that either is certified to perform such testing on human specimens under the Clinical Laboratory Improvement Amendments of 1988 (42 U.S.C. 263a) and 42 CFR part 493, or has met equivalent requirements as determined by the Centers for Medicare and Medicaid Services.

(d) *Ineligible donors*. You must determine the following donors to be ineligible:

(1) A donor whose specimen tests reactive on a screening test for a communicable disease agent in accordance with § 1271.85, except for a donor whose specimen tests reactive on a non-treponemal screening test for syphilis and negative on a specific treponemal confirmatory test;

(2)(i) A donor in whom plasma dilution sufficient to affect the results of communicable disease testing is suspected, unless:

(A) You test a specimen taken from the donor before transfusion or infusion and up to 7 days before recovery of cells or tissue; or

(B) You use an appropriate algorithm designed to evaluate volumes administered in the 48 hours before specimen collection, and the algorithm shows that plasma dilution sufficient to affect the results of communicable disease testing has not occurred.

(ii) Clinical situations in which you must suspect plasma dilution sufficient to affect the results of communicable disease testing include but are not limited to the following:

(A) Blood loss is known or suspected in a donor over 12 years of age, and the donor has received a transfusion or infusion of any of the following, alone or in combination:

(1) More than 2,000 milliliters (mL) of blood (e.g., whole blood, red blood cells) or colloids within 48 hours before death or specimen collection, whichever occurred earlier, or

(2) More than 2,000 mL of crystalloids within 1 hour before death or specimen collection, whichever occurred earlier.

(B) Regardless of the presence or absence of blood loss, the donor is 12 years of age or younger and has received a transfusion or infusion of any amount of any of the following, alone or in combination:

(1) Blood (e.g., whole blood, red blood cells) or colloids within 48 hours before death or specimen collection, whichever occurred earlier, or

(2) Crystalloids within 1 hour before death or specimen collection, whichever occurred earlier.

[69 FR 29830, May 25, 2004, as amended at 70 FR 29952, May 25, 2005]

**§ 1271.85 What donor testing is required for different types of cells and tissues?**

(a) *All donors.* To adequately and appropriately reduce the risk of transmission of relevant communicable diseases, and except as provided under § 1271.90, you must test a specimen from the donor of cells or tissue, whether viable or nonviable, for evidence of infection due to relevant communicable disease agents, including:

(1) Human immunodeficiency virus, type 1;

(2) Human immunodeficiency virus, type 2;

(3) Hepatitis B virus;

(4) Hepatitis C virus; and

(5) *Treponema pallidum*.

(b) *Donors of viable, leukocyte-rich cells or tissue.* In addition to the relevant communicable disease agents for which testing is required under paragraph (a) of this section, and except as provided under § 1271.90,

(1) You must test a specimen from the donor of viable, leukocyte-rich cells or tissue to adequately and appropriately reduce the risk of transmission of relevant cell-associated communicable diseases, including:

(i) Human T-lymphotropic virus, type I; and

(ii) Human T-lymphotropic virus, type II.

(2) You must test a specimen from the donor of viable, leukocyte-rich cells or tissue for evidence of infection due to cytomegalovirus (CMV), to adequately and appropriately reduce the risk of transmission. You must establish and maintain a standard operating procedure governing the release of an HCT/P from a donor whose specimen tests reactive for CMV.

(c) *Donors of reproductive cells or tissue.* In addition to the communicable disease agents for which testing is required under paragraphs (a) and (b) of this section, as applicable, and except as provided under § 1271.90, you must test a specimen from the donor of reproductive cells or tissue to adequately and appropriately reduce the risk of transmission of relevant communicable disease agents of the genitourinary tract. Such testing must include testing for the communicable disease agents listed in paragraphs (c)(1) and (c)(2) of this section. However, if the reproductive cells or tissues are recovered by a method that ensures freedom from contamination of the cells or tissue by infectious disease organisms that may be present in the genitourinary tract, then testing for the communicable disease agents listed in paragraphs (c)(1) and (c)(2) of this section is not required. Communicable disease agents of the genitourinary tract for which you must test include:

(1) *Chlamydia trachomatis*; and

(2) *Neisseria gonorrhoea*.

§ 1271.90

21 CFR Ch. I (4–1–20 Edition)

(d) *Retesting anonymous semen donors.* Except as provided under § 1271.90 and except for directed reproductive donors as defined in § 1271.3(1), at least 6 months after the date of donation of semen from anonymous donors, you must collect a new specimen from the donor and test it for evidence of infection due to the communicable disease agents for which testing is required under paragraphs (a), (b), and (c) of this section.

(e) *Dura mater.* For donors of dura mater, you must perform an adequate assessment designed to detect evidence of transmissible spongiform encephalopathy.

**§ 1271.90 Are there other exceptions and what labeling requirements apply?**

(a) *Donor-eligibility determination not required.* You are not required to make a donor-eligibility determination under § 1271.50 or to perform donor screening or testing under §§ 1271.75, 1271.80 and 1271.85 for:

(1) Cells and tissues for autologous use; or

(2) Reproductive cells or tissue donated by a sexually intimate partner of the recipient for reproductive use; or

(3) Cryopreserved cells or tissue for reproductive use, other than embryos, originally excepted under paragraphs (a)(1) or (a)(2) of this section at the time of donation, that are subsequently intended for directed donation, provided that:

(i) Additional donations are unavailable, for example, due to the infertility or health of a donor of the cryopreserved reproductive cells or tissue; and

(ii) Appropriate measures are taken to screen and test the donor(s) before transfer to the recipient.

(4) A cryopreserved embryo, originally excepted under paragraph (a)(2) of this section at the time of recovery or cryopreservation, that is subsequently intended for directed or anonymous donation. When possible, appropriate measures should be taken to screen and test the semen and oocyte donors before transfer of the embryo to the recipient.

(b) *Exceptions for reproductive use.* An embryo originally intended for repro-

ductive use for a specific individual or couple that is subsequently intended for directed or anonymous donation for reproductive use is excepted from the prohibition on use under § 1271.45(c) even when the applicable donor eligibility requirements under subpart C of this part are not met. Nothing in this paragraph creates an exception for deficiencies that occurred in making the donor eligibility determination for either the oocyte donor or the semen donor as required under § 1271.45(b), or for deficiencies in performing donor screening or testing, as required under §§ 1271.75, 1271.80, and 1271.85.

(c) *Required labeling.* As applicable, you must prominently label an HCT/P described in paragraphs (a) and (b) of this section as follows:

(1) “FOR AUTOLOGOUS USE ONLY,” if it is stored for autologous use.

(2) “NOT EVALUATED FOR INFECTIOUS SUBSTANCES,” unless you have performed all otherwise applicable screening and testing under §§ 1271.75, 1271.80, and 1271.85. This paragraph does not apply to reproductive cells or tissue labeled in accordance with paragraph (c)(6) of this section.

(3) Unless the HCT/P is for autologous use only, “WARNING: Advise recipient of communicable disease risks,”

(i) When the donor-eligibility determination under § 1271.50(a) is not performed or is not completed; or

(ii) If the results of any screening or testing performed indicate:

(A) The presence of relevant communicable disease agents and/or

(B) Risk factors for or clinical evidence of relevant communicable disease agents or diseases.

(4) With the Biohazard legend shown in § 1271.3(h), if the results of any screening or testing performed indicate:

(i) The presence of relevant communicable disease agents and/or

(ii) Risk factors for or clinical evidence of relevant communicable disease agents or diseases.

(5) “WARNING: Reactive test results for (name of disease agent or disease),” in the case of reactive test results.

(6) “Advise recipient that screening and testing of the donor(s) were not

performed at the time of recovery or cryopreservation of the reproductive cells or tissue, but have been performed subsequently,” for paragraphs (a)(3) or (a)(4) of this section.

[69 FR 29830, May 25, 2004, as amended at 70 FR 29952, May 25, 2005; 81 FR 40517, June 22, 2016]

### Subpart D—Current Good Tissue Practice

SOURCE: 69 FR 68681, Nov. 24, 2004, unless otherwise noted.

#### § 1271.145 Prevention of the introduction, transmission, or spread of communicable diseases.

You must recover, process, store, label, package, and distribute HCT/Ps, and screen and test cell and tissue donors, in a way that prevents the introduction, transmission, or spread of communicable diseases.

#### § 1271.150 Current good tissue practice requirements.

(a) *General.* This subpart D and subpart C of this part set forth current good tissue practice (CGTP) requirements. You must follow CGTP requirements to prevent the introduction, transmission, or spread of communicable diseases by HCT/Ps (e.g., by ensuring that the HCT/Ps do not contain communicable disease agents, that they are not contaminated, and that they do not become contaminated during manufacturing). Communicable diseases include, but are not limited to, those transmitted by viruses, bacteria, fungi, parasites, and transmissible spongiform encephalopathy agents. CGTP requirements govern the methods used in, and the facilities and controls used for, the manufacture of HCT/Ps, including but not limited to all steps in recovery, donor screening, donor testing, processing, storage, labeling, packaging, and distribution. The CGTP provisions specifically governing determinations of donor eligibility, including donor screening and testing, are set out separately in subpart C of this part.

(b) *Core CGTP requirements.* The following are core CGTP requirements:

(1) Requirements relating to facilities in § 1271.190(a) and (b);

(2) Requirements relating to environmental control in § 1271.195(a);

(3) Requirements relating to equipment in § 1271.200(a);

(4) Requirements relating to supplies and reagents in § 1271.210(a) and (b);

(5) Requirements relating to recovery in § 1271.215;

(6) Requirements relating to processing and process controls in § 1271.220;

(7) Requirements relating to labeling controls in § 1271.250(a) and (b);

(8) Requirements relating to storage in § 1271.260 (a) through (d);

(9) Requirements relating to receipt, predistribution shipment, and distribution of an HCT/P in § 1271.265(a) through (d); and

(10) Requirements relating to donor eligibility determinations, donor screening, and donor testing in §§ 1271.50, 1271.75, 1271.80, and 1271.85.

(c) *Compliance with applicable requirements—*(1) *Manufacturing arrangements* (i) If you are an establishment that engages in only some operations subject to the regulations in this subpart and subpart C of this part, and not others, then you need only comply with those requirements applicable to the operations that you perform.

(ii) If you engage another establishment (e.g., a laboratory to perform communicable disease testing, or an irradiation facility to perform terminal sterilization), under a contract, agreement, or other arrangement, to perform any step in manufacture for you, that establishment is responsible for complying with requirements applicable to that manufacturing step.

(iii) Before entering into a contract, agreement, or other arrangement with another establishment to perform any step in manufacture for you, you must ensure that the establishment complies with applicable CGTP requirements. If, during the course of this contract, agreement, or other arrangement, you become aware of information suggesting that the establishment may no longer be in compliance with such requirements, you must take reasonable steps to ensure the establishment complies with those requirements. If you determine that the establishment is

not in compliance with those requirements, you must terminate your contract, agreement, or other arrangement with the establishment.

(2) If you are the establishment that determines that an HCT/P meets all release criteria and makes the HCT/P available for distribution, whether or not you are the actual distributor, you are responsible for reviewing manufacturing and tracking records to determine that the HCT/P has been manufactured and tracked in compliance with the requirements of this subpart and subpart C of this part and any other applicable requirements.

(3) With the exception of §§ 1271.150(c) and 1271.155 of this subpart, the regulations in this subpart are not being implemented for reproductive HCT/Ps described in § 1271.10 and regulated solely under section 361 of the Public Health Service Act and the regulations in this part, or for the establishments that manufacture them.

(d) *Compliance with parts 210, 211, and 820 of this chapter.* With respect to HCT/Ps that are drugs (subject to review under an application submitted under section 505 of the Federal Food, Drug, and Cosmetic Act or under a biological product license application under section 351 of the Public Health Service Act) or that are devices (subject to pre-market review or notification under the device provisions of the act or under a biological product license application under section 351 of the Public Health Service Act), the procedures contained in this subpart and in subpart C of this part and the current good manufacturing practice regulations in parts 210 and 211 of this chapter and the quality system regulations in part 820 of this chapter supplement, and do not supersede, each other unless the regulations explicitly provide otherwise. In the event that a regulation in part 1271 of this chapter is in conflict with a requirement in parts 210, 211, or 820 of this chapter, the regulations more specifically applicable to the product in question will supersede the more general.

(e) *Where appropriate.* When a requirement is qualified by “where appropriate,” it is deemed to be “appropriate” unless you can document justification otherwise. A requirement is

“appropriate” if nonimplementation of the requirement could reasonably be expected to result in the HCT/P not meeting its specified requirements related to prevention of introduction, transmission, or spread of communicable diseases, or in your inability to carry out any necessary corrective action.

#### § 1271.155 Exemptions and alternatives.

(a) *General.* You may request an exemption from or alternative to any requirement in subpart C or D of this part.

(b) *Request for exemption or alternative.* Submit your request under this section to the Director of the appropriate Center (the Director), e.g., the Center for Biologics Evaluation and Research or the Center for Devices and Radiological Health. The request must be accompanied by supporting documentation, including all relevant valid scientific data, and must contain either:

(1) Information justifying the requested exemption from the requirement, or

(2) A description of a proposed alternative method of meeting the requirement.

(c) *Criteria for granting an exemption or alternative.* The Director may grant an exemption or alternative if he or she finds that such action is consistent with the goals of protecting the public health and/or preventing the introduction, transmission, or spread of communicable diseases and that:

(1) The information submitted justifies an exemption; or

(2) The proposed alternative satisfies the purpose of the requirement.

(d) *Form of request.* You must ordinarily make your request for an exemption or alternative in writing (hard copy or electronically). However, if circumstances make it difficult (e.g., there is inadequate time) to submit your request in writing, you may make the request orally, and the Director may orally grant an exemption or alternative. You must follow your oral request with an immediate written request, to which the Director will respond in writing.

(e) *Operation under exemption or alternative.* You must not begin operating



under the terms of a requested exemption or alternative until the exemption or alternative has been granted. You may apply for an extension of an exemption or alternative beyond its expiration date, if any.

(f) *Documentation.* If you operate under the terms of an exemption or alternative, you must maintain documentation of:

(1) FDA's grant of the exemption or alternative, and

(2) The date on which you began operating under the terms of the exemption or alternative.

(g) *Issuance of an exemption or alternative by the Director.* In a public health emergency, the Director may issue an exemption from, or alternative to, any requirement in part 1271. The Director may issue an exemption or alternative under this section if the exemption or alternative is necessary to assure that certain HCT/Ps will be available in a specified location to respond to an unanticipated immediate need for those HCT/Ps.

**§ 1271.160 Establishment and maintenance of a quality program.**

(a) *General.* If you are an establishment that performs any step in the manufacture of HCT/Ps, you must establish and maintain a quality program intended to prevent the introduction, transmission, or spread of communicable diseases through the manufacture and use of HCT/Ps. The quality program must be appropriate for the specific HCT/Ps manufactured and the manufacturing steps performed. The quality program must address all core CGTP requirements listed in § 1271.150(b).

(b) *Functions.* Functions of the quality program must include:

(1) Establishing and maintaining appropriate procedures relating to core CGTP requirements, and ensuring compliance with the requirements of § 1271.180 with respect to such procedures, including review, approval, and revision;

(2) Ensuring that procedures exist for receiving, investigating, evaluating, and documenting information relating to core CGTP requirements, including complaints, and for sharing any information pertaining to the possible con-

tamination of the HCT/P or the potential for transmission of a communicable disease by the HCT/P with the following:

(i) Other establishments that are known to have recovered HCT/Ps from the same donor;

(ii) Other establishments that are known to have performed manufacturing steps with respect to the same HCT/P; and

(iii) Relating to consignees, in the case of such information received after the HCT/P is made available for distribution, shipped to the consignee, or administered to the recipient, procedures must include provisions for assessing risk and appropriate followup, and evaluating the effect this information has on the HCT/P and for the notification of all entities to whom the affected HCT/P was distributed, the quarantine and recall of the HCT/P, and/or reporting to FDA, as necessary.

(3) Ensuring that appropriate corrective actions relating to core CGTP requirements, including reaudits of deficiencies, are taken and documented, as necessary. You must verify corrective actions to ensure that such actions are effective and are in compliance with CGTP. Where appropriate, corrective actions must include both short-term action to address the immediate problem and long-term action to prevent the problem's recurrence. Documentation of corrective actions must include, where appropriate:

(i) Identification of the HCT/P affected and a description of its disposition;

(ii) The nature of the problem requiring corrective action;

(iii) A description of the corrective action taken; and

(iv) The date(s) of the corrective action.

(4) Ensuring the proper training and education of personnel involved in activities related to core CGTP requirements;

(5) Establishing and maintaining appropriate monitoring systems as necessary to comply with the requirements of this subpart (e.g., environmental monitoring);

(6) Investigating and documenting HCT/P deviations and trends of HCT/P

## § 1271.170

deviations relating to core CGTP requirements and making reports if required under § 1271.350(b) or other applicable regulations. Each investigation must include a review and evaluation of the HCT/P deviation, the efforts made to determine the cause, and the implementation of corrective action(s) to address the HCT/P deviation and prevent recurrence.

(c) *Audits.* You must periodically perform for management review a quality audit, as defined in § 1271.3(gg), of activities related to core CGTP requirements.

(d) *Computers.* You must validate the performance of computer software for the intended use, and the performance of any changes to that software for the intended use, if you rely upon the software to comply with core CGTP requirements and if the software either is custom software or is commercially available software that has been customized or programmed (including software programmed to perform a user defined calculation or table) to perform a function related to core CGTP requirements. You must verify the performance of all other software for the intended use if you rely upon it to comply with core CGTP requirements. You must approve and document these activities and results before implementation.

### § 1271.170 Personnel.

(a) *General.* You must have personnel sufficient to ensure compliance with the requirements of this part.

(b) *Competent performance of functions.* You must have personnel with the necessary education, experience, and training to ensure competent performance of their assigned functions. Personnel must perform only those activities for which they are qualified and authorized.

(c) *Training.* You must train all personnel, and retrain as necessary, to perform their assigned responsibilities adequately.

### § 1271.180 Procedures.

(a) *General.* You must establish and maintain procedures appropriate to meet core CGTP requirements for all steps that you perform in the manufacture of HCT/Ps. You must design these

## 21 CFR Ch. I (4–1–20 Edition)

procedures to prevent circumstances that increase the risk of the introduction, transmission, or spread of communicable diseases through the use of HCT/Ps.

(b) *Review and approval.* Before implementation, a responsible person must review and approve these procedures.

(c) *Availability.* These procedures must be readily available to the personnel in the area where the operations to which they relate are performed, or in a nearby area if such availability is impractical.

(d) *Standard procedures.* If you adopt current standard procedures from another organization, you must verify that the procedures meet the requirements of this part and are appropriate for your operations.

### § 1271.190 Facilities.

(a) *General.* Any facility used in the manufacture of HCT/Ps must be of suitable size, construction, and location to prevent contamination of HCT/Ps with communicable disease agents and to ensure orderly handling of HCT/Ps without mix-ups. You must maintain the facility in a good state of repair. You must provide lighting, ventilation, plumbing, drainage, and access to sinks and toilets that are adequate to prevent the introduction, transmission, or spread of communicable disease.

(b) *Facility cleaning and sanitation.* (1) You must maintain any facility used in the manufacture of HCT/Ps in a clean, sanitary, and orderly manner, to prevent the introduction, transmission, or spread of communicable disease.

(2) You must dispose of sewage, trash, and other refuse in a timely, safe, and sanitary manner.

(c) *Operations.* You must divide a facility used in the manufacture of HCT/Ps into separate or defined areas of adequate size for each operation that takes place in the facility, or you must establish and maintain other control systems to prevent improper labeling, mix-ups, contamination, cross-contamination, and accidental exposure of HCT/Ps to communicable disease agents.

(d) *Procedures and records.* (1) You must establish and maintain procedures for facility cleaning and sanitation for the purpose of preventing the

introduction, transmission, or spread of communicable disease. These procedures must assign responsibility for sanitation and must describe in sufficient detail the cleaning methods to be used and the schedule for cleaning the facility.

(2) You must document, and maintain records of, all cleaning and sanitation activities performed to prevent contamination of HCT/Ps. You must retain such records 3 years after their creation.

**§ 1271.195 Environmental control and monitoring.**

(a) *Environmental control.* Where environmental conditions could reasonably be expected to cause contamination or cross-contamination of HCT/Ps or equipment, or accidental exposure of HCT/Ps to communicable disease agents, you must adequately control environmental conditions and provide proper conditions for operations. Where appropriate, you must provide for the following control activities or systems:

- (1) Temperature and humidity controls;
- (2) Ventilation and air filtration;
- (3) Cleaning and disinfecting of rooms and equipment to ensure aseptic processing operations; and
- (4) Maintenance of equipment used to control conditions necessary for aseptic processing operations.

(b) *Inspections.* You must inspect each environmental control system periodically to verify that the system, including necessary equipment, is adequate and functioning properly. You must take appropriate corrective action as necessary.

(c) *Environmental monitoring.* You must monitor environmental conditions where environmental conditions could reasonably be expected to cause contamination or cross-contamination of HCT/Ps or equipment, or accidental exposure of HCT/Ps to communicable disease agents. Where appropriate, you must provide environmental monitoring for microorganisms.

(d) *Records.* You must document, and maintain records of, environmental control and monitoring activities.

**§ 1271.200 Equipment.**

(a) *General.* To prevent the introduction, transmission, or spread of communicable diseases, equipment used in the manufacture of HCT/Ps must be of appropriate design for its use and must be suitably located and installed to facilitate operations, including cleaning and maintenance. Any automated, mechanical, electronic, or other equipment used for inspection, measuring, or testing in accordance with this part must be capable of producing valid results. You must clean, sanitize, and maintain equipment according to established schedules.

(b) *Procedures and schedules.* You must establish and maintain procedures for cleaning, sanitizing, and maintaining equipment to prevent malfunctions, contamination or cross-contamination, accidental exposure of HCT/Ps to communicable disease agents, and other events that could reasonably be expected to result in the introduction, transmission, or spread of communicable diseases.

(c) *Calibration of equipment.* Where appropriate, you must routinely calibrate according to established procedures and schedules all automated, mechanical, electronic, or other equipment used for inspection, measuring, and testing in accordance with this part.

(d) *Inspections.* You must routinely inspect equipment for cleanliness, sanitation, and calibration, and to ensure adherence to applicable equipment maintenance schedules.

(e) *Records.* You must document and maintain records of all equipment maintenance, cleaning, sanitizing, calibration, and other activities performed in accordance with this section. You must display records of recent maintenance, cleaning, sanitizing, calibration, and other activities on or near each piece of equipment, or make the records readily available to the individuals responsible for performing these activities and to the personnel using the equipment. You must maintain records of the use of each piece of equipment, including the identification of each HCT/P manufactured with that equipment.

## § 1271.210

## 21 CFR Ch. I (4–1–20 Edition)

### § 1271.210 Supplies and reagents.

(a) *Verification.* You must not use supplies and reagents until they have been verified to meet specifications designed to prevent circumstances that increase the risk of the introduction, transmission, or spread of communicable diseases. Verification may be accomplished by the establishment that uses the supply or reagent, or by the vendor of the supply or reagent.

(b) *Reagents.* Reagents used in processing and preservation of HCT/Ps must be sterile, where appropriate.

(c) *In-house reagents.* You must validate and/or verify the processes used for production of in-house reagents.

(d) *Records.* You must maintain the following records pertaining to supplies and reagents:

(1) Records of the receipt of each supply or reagent, including the type, quantity, manufacturer, lot number, date of receipt, and expiration date;

(2) Records of the verification of each supply or reagent, including test results or, in the case of vendor verification, a certificate of analysis from the vendor; and

(3) Records of the lot of supply or reagent used in the manufacture of each HCT/P.

### § 1271.215 Recovery.

If you are an establishment that recovers HCT/Ps, you must recover each HCT/P in a way that does not cause contamination or cross-contamination during recovery, or otherwise increase the risk of the introduction, transmission, or spread of communicable disease through the use of the HCT/P.

### § 1271.220 Processing and process controls.

(a) *General.* If you are an establishment that processes HCT/Ps, you must process each HCT/P in a way that does not cause contamination or cross-contamination during processing, and that prevents the introduction, transmission, or spread of communicable disease through the use of the HCT/P.

(b) *Pooling.* Human cells or tissue from two or more donors must not be pooled (placed in physical contact or mixed in a single receptacle) during manufacturing.

(c) *In-process control and testing.* You must ensure that specified requirements, consistent with paragraph (a) of this section, for in-process controls are met, and that each in-process HCT/P is controlled until the required inspection and tests or other verification activities have been completed, or necessary approvals are received and documented. Sampling of in-process HCT/Ps must be representative of the material to be evaluated.

(d) *Dura mater.* (1) When there is a published validated process that reduces the risk of transmissible spongiform encephalopathy, you must use this process for dura mater (or an equivalent process that you have validated), unless following this process adversely affects the clinical utility of the dura mater.

(2) When you use a published validated process, you must verify such a process in your establishment.

### § 1271.225 Process changes.

Any change to a process must be verified or validated in accordance with §1271.230, to ensure that the change does not create an adverse impact elsewhere in the operation, and must be approved before implementation by a responsible person with appropriate knowledge and background. You must communicate approved changes to the appropriate personnel in a timely manner.

### § 1271.230 Process validation.

(a) *General.* Where the results of processing described in §1271.220 cannot be fully verified by subsequent inspection and tests, you must validate and approve the process according to established procedures. The validation activities and results must be documented, including the date and signature of the individual(s) approving the validation.

(b) *Written representation.* Any written representation that your processing methods reduce the risk of transmission of communicable disease by an HCT/P, including but not limited to, a representation of sterility or pathogen inactivation of an HCT/P, must be based on a fully verified or validated process.

(c) *Changes.* When changes to a validated process subject to paragraph (a) of this section occur, you must review and evaluate the process and perform revalidation where appropriate. You must document these activities.

**§ 1271.250 Labeling controls.**

(a) *General.* You must establish and maintain procedures to control the labeling of HCT/Ps. You must design these procedures to ensure proper HCT/P identification and to prevent mix-ups.

(b) *Verification.* Procedures must include verification of label accuracy, legibility, and integrity.

(c) *Labeling requirements.* Procedures must ensure that each HCT/P is labeled in accordance with all applicable labeling requirements, including those in §§ 1271.55, 1271.60, 1271.65, 1271.90, 1271.290, and 1271.370, and that each HCT/P made available for distribution is accompanied by documentation of the donor eligibility determination as required under § 1271.55.

**§ 1271.260 Storage.**

(a) *Control of storage areas.* You must control your storage areas and stock rooms to prevent:

(1) Mix-ups, contamination, and cross-contamination of HCT/Ps, supplies, and reagents, and

(2) An HCT/P from being improperly made available for distribution.

(b) *Temperature.* You must store HCT/Ps at an appropriate temperature.

(c) *Expiration date.* Where appropriate, you must assign an expiration date to each HCT/P based on the following factors:

(1) HCT/P type;

(2) Processing, including the method of preservation;

(3) Storage conditions; and

(4) Packaging.

(d) *Corrective action.* You must take and document corrective action whenever proper storage conditions are not met.

(e) *Acceptable temperature limits.* You must establish acceptable temperature limits for storage of HCT/Ps at each step of the manufacturing process to inhibit the growth of infectious agents. You must maintain and record storage temperatures for HCT/Ps. You must pe-

riodically review recorded temperatures to ensure that temperatures have been within acceptable limits.

**§ 1271.265 Receipt, predistribution shipment, and distribution of an HCT/P.**

(a) *Receipt.* You must evaluate each incoming HCT/P for the presence and significance of microorganisms and inspect for damage and contamination. You must determine whether to accept, reject, or place in quarantine each incoming HCT/P, based upon pre-established criteria designed to prevent communicable disease transmission.

(b) *Predistribution shipment.* If you ship an HCT/P within your establishment or between establishments (e.g., procurer to processor) and the HCT/P is not available for distribution as described in paragraph (c) of this section, you must first determine and document whether pre-established criteria designed to prevent communicable disease transmission have been met, and you must ship the HCT/P in quarantine.

(c) *Availability for distribution.* (1) Before making an HCT/P available for distribution, you must review manufacturing and tracking records pertaining to the HCT/P, and, on the basis of that record review, you must verify and document that the release criteria have been met. A responsible person must document and date the determination that an HCT/P is available for distribution.

(2) You must not make available for distribution an HCT/P that is in quarantine, is contaminated, is recovered from a donor who has been determined to be ineligible or for whom a donor-eligibility determination has not been completed (except as provided under §§ 1271.60, 1271.65, and 1271.90), or that otherwise does not meet release criteria designed to prevent communicable disease transmission.

(3) You must not make available for distribution any HCT/P manufactured under a departure from a procedure relevant to preventing risks of communicable disease transmission, unless a responsible person has determined that the departure does not increase the risk of communicable disease through the use of the HCT/P. You must record

and justify any departure from a procedure at the time of its occurrence.

(d) *Packaging and shipping.* Packaging and shipping containers must be designed and constructed to protect the HCT/P from contamination. For each type of HCT/P, you must establish appropriate shipping conditions to be maintained during transit.

(e) *Procedures.* You must establish and maintain procedures, including release criteria, for the activities in paragraphs (a) through (d) of this section. You must document these activities. Documentation must include:

(1) Identification of the HCT/P and the establishment that supplied the HCT/P;

(2) Activities performed and the results of each activity;

(3) Date(s) of activity;

(4) Quantity of HCT/P subject to the activity; and

(5) Disposition of the HCT/P (e.g., identity of consignee).

(f) *Return to inventory.* You must establish and maintain procedures to determine if an HCT/P that is returned to your establishment is suitable to be returned to inventory.

#### § 1271.270 Records.

(a) *General.* You must maintain records concurrently with the performance of each step required in this subpart and subpart C of this part. Any requirement in this part that an action be documented involves the creation of a record, which is subject to the requirements of this section. All records must be accurate, indelible, and legible. The records must identify the person performing the work and the dates of the various entries, and must be as detailed as necessary to provide a complete history of the work performed and to relate the records to the particular HCT/P involved.

(b) *Records management system.* You must establish and maintain a records management system relating to core CGTP requirements. Under this system, records pertaining to a particular HCT/P must be maintained in such a way as to facilitate review of the HCT/Ps history before making it available for distribution and, if necessary, subsequent to the HCT/Ps release as part of a followup evaluation or investiga-

tion. Records pertinent to the manufacture of HCT/Ps (e.g., labeling and packaging procedures, and equipment logs) must also be maintained and organized under the records management system. If records are maintained in more than one location, then the records management system must be designed to ensure prompt identification, location, and retrieval of all records.

(c) *Methods of retention.* You may maintain records required under this subpart electronically, as original paper records, or as true copies such as photocopies, microfiche, or microfilm. Equipment that is necessary to make the records available and legible, such as computer and reader equipment, must be readily available. Records stored in electronic systems must be backed up.

(d) *Length of retention.* You must retain all records for 10 years after their creation, unless stated otherwise in this part. However, you must retain the records pertaining to a particular HCT/P at least 10 years after the date of its administration, or if the date of administration is not known, then at least 10 years after the date of the HCT/Ps distribution, disposition, or expiration, whichever is latest. You must retain records for archived specimens of dura mater for 10 years after the appropriate disposition of the specimens.

(e) *Contracts and agreements.* You must maintain the name and address and a list of the responsibilities of any establishment that performs a manufacturing step for you. This information must be available during an inspection conducted under § 1271.400.

#### § 1271.290 Tracking.

(a) *General.* If you perform any step in the manufacture of an HCT/P in which you handle the HCT/P, you must track each such HCT/P in accordance with this section, to facilitate the investigation of actual or suspected transmission of communicable disease and take appropriate and timely corrective action.

(b) *System of HCT/P tracking.* (1) You must establish and maintain a system of HCT/P tracking that enables the tracking of all HCT/Ps from:

(i) The donor to the consignee or final disposition; and

(ii) The consignee or final disposition to the donor.

(2) Alternatively, if you are an establishment that performs some but not all of the steps in the manufacture of an HCT/P in which you handle the HCT/P, you may participate in a system of HCT/P tracking established and maintained by another establishment responsible for other steps in the manufacture of the same HCT/P, provided that the tracking system complies with all the requirements of this section.

(c) *Distinct identification code.* As part of your tracking system, you must ensure: That each HCT/P that you manufacture is assigned and labeled with a distinct identification code, e.g., alphanumeric, that relates the HCT/P to the donor and to all records pertaining to the HCT/P; and that labeling includes information designed to facilitate effective tracking, using the distinct identification code, from the donor to the recipient and from the recipient to the donor. Except as described in §1271.55(a)(1), you must create such a code specifically for tracking, and it may not include an individual's name, social security number, or medical record number. You may adopt a distinct identification code assigned by another establishment engaged in the manufacturing process, or you may assign a new code. If you assign a new code to an HCT/P, you must establish and maintain procedures for relating the new code to the old code.

(d) *Tracking from consignee to donor.* As part of your tracking system, you must establish and maintain a method for recording the distinct identification code and type of each HCT/P distributed to a consignee to enable tracking from the consignee to the donor.

(e) *Tracking from donor to consignee or final disposition.* As part of your tracking system, you must establish and maintain a method for documenting the disposition of each of your HCT/Ps, to enable tracking from the donor to the consignee or final disposition. The information you maintain must permit the prompt identification of the consignee of the HCT/P, if any.

(f) *Consignees.* At or before the time of distribution of an HCT/P to a consignee, you must inform the consignee in writing of the requirements in this section and of the tracking system that you have established and are maintaining to comply with these requirements.

(g) *Requirements specific to dura mater donors.* You must archive appropriate specimens from each donor of dura mater, under appropriate storage conditions, and for the appropriate duration, to enable testing of the archived material for evidence of transmissible spongiform encephalopathy, and to enable appropriate disposition of any affected nonadministered dura mater tissue, if necessary.

[69 FR 68681, Nov. 24, 2004, as amended at 70 FR 29952, May 25, 2005]

#### § 1271.320 Complaint file.

(a) *Procedures.* You must establish and maintain procedures for the review, evaluation, and documentation of complaints as defined in §1271.3(aa), relating to core current good tissue practice (CGTP) requirements, and the investigation of complaints as appropriate.

(b) *Complaint file.* You must maintain a record of complaints that you receive in a file designated for complaints. The complaint file must contain sufficient information about each complaint for proper review and evaluation of the complaint (including the distinct identification code of the HCT/P that is the subject of the complaint) and for determining whether the complaint is an isolated event or represents a trend. You must make the complaint file available for review and copying upon request from FDA.

(c) *Review and evaluation of complaints.* You must review and evaluate each complaint relating to core CGTP requirements to determine if the complaint is related to an HCT/P deviation or to an adverse reaction, and to determine if a report under §1271.350 or another applicable regulation is required. As soon as practical, you must review, evaluate, and investigate each complaint that represents an event required to be reported to FDA, as described in §1271.350. You must review and evaluate a complaint relating to

core CGTP requirements that does not represent an event required to be reported to determine whether an investigation is necessary; an investigation may include referring a copy of the complaint to another establishment that performed manufacturing steps pertinent to the complaint. When no investigation is made, you must maintain a record that includes the reason no investigation was made, and the name of the individual(s) responsible for the decision not to investigate.

### Subpart E—Additional Requirements for Establishments Described in § 1271.10

SOURCE: 69 FR 68686, Nov. 24, 2004, unless otherwise noted.

#### § 1271.330 Applicability.

The provisions set forth in this subpart are being implemented for non-reproductive HCT/Ps described in § 1271.10 and regulated solely under section 361 of the Public Health Service Act and the regulations in this part, and for the establishments that manufacture those HCT/Ps. HCT/Ps that are drugs or devices regulated under the act, or are biological products regulated under section 351 of the Public Health Service Act, are not subject to the regulations set forth in this subpart.

#### § 1271.350 Reporting.

(a) *Adverse reaction reports.* (1) You must investigate any adverse reaction involving a communicable disease related to an HCT/P that you made available for distribution. You must report to FDA an adverse reaction involving a communicable disease if it:

- (i) Is fatal;
- (ii) Is life-threatening;
- (iii) Results in permanent impairment of a body function or permanent damage to body structure; or
- (iv) Necessitates medical or surgical intervention, including hospitalization.

(2) You must submit each report on a Form FDA-3500A to the address in paragraph (a)(5) of this section within 15 calendar days of initial receipt of the information.

(3) You must, as soon as practical, investigate all adverse reactions that are the subject of these 15-day reports and must submit followup reports within 15 calendar days of the receipt of new information or as requested by FDA. If additional information is not obtainable, a followup report may be required that describes briefly the steps taken to seek additional information and the reasons why it could not be obtained.

(4) You may obtain copies of the reporting form (FDA-3500A) from the Center for Biologics Evaluation and Research (see address in paragraph (a)(5) of this section). Electronic Form FDA-3500A may be obtained at <http://www.fda.gov/medwatch> or at <http://www.hhs.gov/forms>.

(5) You must submit two copies of each report described in this paragraph to the Food and Drug Administration, Center for Biologics Evaluation and Research, Document Control Center, 10903 New Hampshire Ave., Bldg. 71, Rm. G112, Silver Spring, MD 20993-0002. FDA may waive the requirement for the second copy in appropriate circumstances.

(b) *Reports of HCT/P deviations.* (1) You must investigate all HCT/P deviations related to a distributed HCT/P for which you performed a manufacturing step.

(2) You must report any such HCT/P deviation relating to the core CGTP requirements, if the HCT/P deviation occurred in your facility or in a facility that performed a manufacturing step for you under contract, agreement, or other arrangement. Each report must contain a description of the HCT/P deviation, information relevant to the event and the manufacture of the HCT/P involved, and information on all follow-up actions that have been or will be taken in response to the HCT/P deviation (e.g., recalls).

(3) You must report each such HCT/P deviation that relates to a core CGTP requirement on Form FDA 3486 within 45 days of the discovery of the event either electronically using the Center for Biologics Evaluation and Research electronic Web-based application or by mail to the Food and Drug Administration, Center for Biologics Evaluation and Research, Document Control Center, 10903 New Hampshire Ave., Bldg.



**Food and Drug Administration, HHS**

**§ 1271.420**

71, Rm. G112, Silver Spring, MD 20993-0002.

[69 FR 68686, Nov. 24, 2004, as amended at 80 FR 18095, Apr. 3, 2015]

**§ 1271.370 Labeling.**

The following requirements apply in addition to §§1271.55, 1271.60, 1271.65, and 1271.90:

(a) You must label each HCT/P made available for distribution clearly and accurately.

(b) The following information must appear on the HCT/P label:

(1) Distinct identification code affixed to the HCT/P container, and assigned in accordance with §1271.290(c);

(2) Description of the type of HCT/P;

(3) Expiration date, if any; and

(4) Warnings required under §1271.60(d)(2), §1271.65(b)(2), or §1271.90(c), if applicable and physically possible. If it is not physically possible to include these warnings on the label, the warnings must, instead, accompany the HCT/P.

(c) The following information must either appear on the HCT/P label or accompany the HCT/P:

(1) Name and address of the establishment that determines that the HCT/P meets release criteria and makes the HCT/P available for distribution;

(2) Storage temperature;

(3) Other warnings, where appropriate; and

(4) Instructions for use when related to the prevention of the introduction, transmission, or spread of communicable diseases.

[69 FR 68686, Nov. 24, 2004, as amended at 70 FR 29952, May 25, 2005; 81 FR 40518, June 22, 2016]

**Subpart F—Inspection and Enforcement of Establishments Described in § 1271.10**

SOURCE: 69 FR 68687, Nov. 24, 2004, unless otherwise noted.

**§ 1271.390 Applicability.**

The provisions set forth in this subpart are applicable only to HCT/Ps described in §1271.10 and regulated solely under section 361 of the Public Health Service Act and the regulations in this part, and to the establishments that

manufacture those HCT/Ps. HCT/Ps that are drugs or devices regulated under the act, or are biological products regulated under section 351 of the Public Health Service Act, are not subject to the regulations set forth in this subpart.

**§ 1271.400 Inspections.**

(a) If you are an establishment that manufactures HCT/Ps described in §1271.10, whether or not under contract, you must permit the Food and Drug Administration (FDA) to inspect any manufacturing location at any reasonable time and in a reasonable manner to determine compliance with applicable provisions of this part. The inspection will be conducted as necessary in the judgment of the FDA and may include your establishment, facilities, equipment, finished and unfinished materials, containers, processes, HCT/Ps, procedures, labeling, records, files, papers, and controls required to be maintained under the part. The inspection may be made with or without prior notification and will ordinarily be made during regular business hours.

(b) The frequency of inspection will be at the agency's discretion.

(c) FDA will call upon the most responsible person available at the time of the inspection of the establishment and may question the personnel of the establishment as necessary to determine compliance with the provisions of this part.

(d) FDA's representatives may take samples, may review and copy any records required to be kept under this part, and may use other appropriate means to record evidence of observations during inspections conducted under this subpart.

(e) The public disclosure of records containing the name or other positive identification of donors or recipients of HCT/Ps will be handled in accordance with FDA's procedures on disclosure of information as set forth in parts 20 and 21 of this chapter.

**§ 1271.420 HCT/Ps offered for import.**

(a) Except as provided in paragraphs (c) and (d) of this section, when an HCT/P is offered for import, the importer of record must notify, either before or at the time of importation, the

director of the district of the Food and Drug Administration (FDA) having jurisdiction over the port of entry through which the HCT/P is imported or offered for import, or such officer of the district as the director may designate to act in his or her behalf in administering and enforcing this part, and must provide sufficient information, including information submitted in the Automated Commercial Environment (ACE) system or any other electronic data interchange system authorized by the U.S. Customs and Border Protection Agency as required in part 1, subpart D of this chapter, for FDA to make an admissibility decision.

(b) Except as provided in paragraphs (c) and (d) of this section, an HCT/P offered for import must be held intact by the importer or consignee, under conditions necessary to prevent transmission of communicable disease, until an admissibility decision is made by FDA. The HCT/P may be transported under quarantine to the consignee, while the FDA district reviews the documentation accompanying the HCT/P. When FDA makes a decision regarding the admissibility of the HCT/P, FDA will notify the importer of record.

(c) This section does not apply to reproductive HCT/Ps regulated solely under section 361 of the Public Health Service Act and the regulations in this part, and donated by a sexually intimate partner of the recipient for reproductive use.

(d) This section does not apply to peripheral blood stem/progenitor cells regulated solely under section 361 of the Public Health Service Act and the regulations in this part, except that paragraphs (a) and (b) of this section apply when circumstances occur under which such imported peripheral blood stem/progenitor cells may present an unreasonable risk of communicable disease transmission which indicates the need to review the information referenced in paragraph (a) of this section.

[69 FR 68687, Nov. 24, 2004, as amended at 81 FR 85873, Nov. 29, 2016]

**§ 1271.440 Orders of retention, recall, destruction, and cessation of manufacturing.**

(a) Upon an agency finding that there are reasonable grounds to believe that an HCT/P is a violative HCT/P because it was manufactured in violation of the regulations in this part and, therefore, the conditions of manufacture of the HCT/P do not provide adequate protections against risks of communicable disease transmission; or the HCT/P is infected or contaminated so as to be a source of dangerous infection to humans; or an establishment is in violation of the regulations in this part and, therefore, does not provide adequate protections against the risks of communicable disease transmission, the Food and Drug Administration (FDA) may take one or more of the following actions:

(1) Serve upon the person who distributed the HCT/P a written order that the HCT/P be recalled and/or destroyed, as appropriate, and upon persons in possession of the HCT/P that the HCT/P must be retained until it is recalled by the distributor, destroyed, or disposed of as agreed by FDA, or the safety of the HCT/P is confirmed;

(2) Take possession of and/or destroy the violative HCT/P; or

(3) Serve upon the establishment an order to cease manufacturing until compliance with the regulations of this part has been achieved. When FDA determines there are reasonable grounds to believe there is a danger to health, such order will be effective immediately. In other situations, such order will be effective after one of the following events, whichever is later:

(i) Passage of 5 working days from the establishment's receipt of the order; or

(ii) If the establishment requests a hearing in accordance with paragraph (e) of this section and part 16 of this chapter, a decision in, and in accordance with, those proceedings.

(b) A written order issued under paragraph (a) of this section will state with particularity the facts that justify the order.

(c)(1) A written order issued under paragraph (a)(1) of this section will ordinarily provide that the HCT/P be recalled and/or destroyed within 5 working days from the date of receipt of the order. After receipt of an order issued under paragraph (a)(1) of this section, the establishment in possession of the HCT/P must not distribute or dispose of the HCT/P in any manner except to recall and/or destroy the HCT/P consistent with the provisions of the order, under the supervision of FDA.

(2) In lieu of paragraph (c)(1) of this section, other arrangements for assuring the proper disposition of the HCT/P may be agreed upon by the person receiving the written order and FDA. Such arrangements may include, among others, providing FDA with records or other written information that adequately ensure that the HCT/P has been recovered, processed, stored, and distributed in conformance with this part, and that, except as provided under §§ 1271.60, 1271.65, and 1271.90, the donor of the cells or tissue for the HCT/P has been determined to be eligible.

(d) A written order issued under paragraph (a)(3) of this section will specify the regulations with which you must achieve compliance and will ordinarily specify the particular operations covered by the order. After receipt of an

order that is in effect and issued under paragraph (a)(3) of this section, you must not resume operations without prior written authorization of FDA.

(e) The recipient of an order issued under this section may request a hearing in accordance with part 16 of this chapter. To request a hearing, the recipient of the written order or prior possessor of such HCT/P must make the request within 5 working days of receipt of a written order for retention, recall, destruction, and/or cessation (or within 5 working days of the agency's possession of an HCT/P under paragraph (a)(2) of this section), in accordance with part 16 of this chapter. An order of destruction will be held in abeyance pending resolution of the hearing request. Upon request under part 16 of this chapter, FDA will provide an opportunity for an expedited hearing for an order of cessation that is not stayed by the Commissioner of Food and Drugs.

(f) FDA will not issue an order for the destruction of reproductive tissue under paragraph (a)(1) of this section, nor will it carry out such destruction itself under paragraph (a)(2) of this section.

**PARTS 1272–1299 [RESERVED]**